

2022 ▶ 2023

General Catalogue









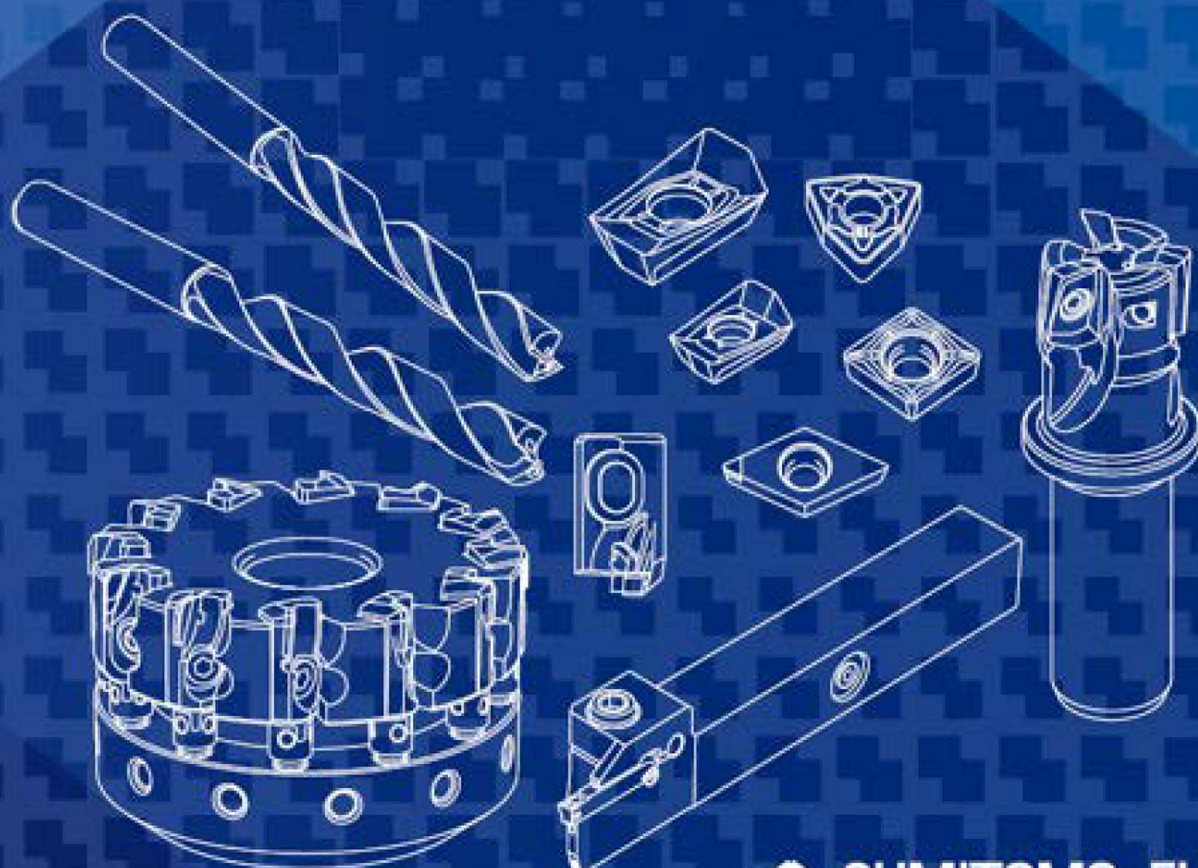

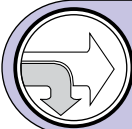
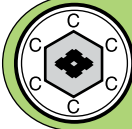

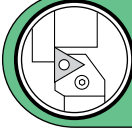

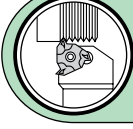

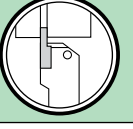

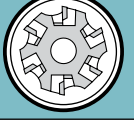
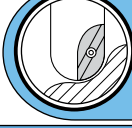
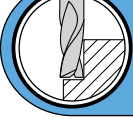
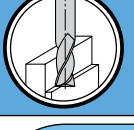
SUMITOMO

CARBIDE - CBN - DIAMOND

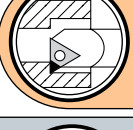
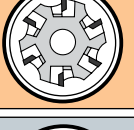
# PERFORMANCE CUTTING TOOLS





	<b>A</b>	Insert Selection
	<b>B</b>	Grades
 	<b>C</b>	Negative & Positive Inserts
	<b>D</b>	External Holders
	<b>E</b>	Boring Bars
  	<b>F</b>	Parting-Off Grooving Threading Holders
 	<b>G</b>	Milling Cutters
	<b>H</b>	Indexable Endmills
 	<b>J</b>	Solid Carbide Endmills
	<b>K</b>	Multi-Drills
 	<b>L</b>	SumiBoron SumiDia
 	<b>M</b>	CBN/PCD Inserts & Tools
  	<b>N P</b>	Guidance Spare Parts Index, App

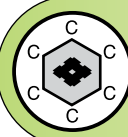

# Contents

	<b>Insert Selection</b>	<b>A1 –</b>
---	-------------------------	-------------

	<b>Grades</b>	<b>B1 –</b>
---	---------------	-------------

	<b>Inserts</b> Negative Type	<b>C1 –</b>
---	---------------------------------	-------------

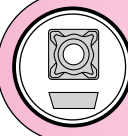
	<b>Inserts</b> Positive Type	<b>C63 –</b>
--	---------------------------------	--------------

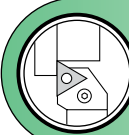
	<b>External Holders</b>	<b>D1 –</b>
---	-------------------------	-------------

	<b>Boring Bars</b>	<b>E1 –</b>
---	--------------------	-------------

	<b>Grooving Holders</b> <b>Parting-Off Holders</b>	<b>F1 –</b>
---	---	-------------

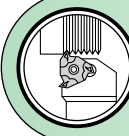
	<b>Threading Holders</b>	<b>F62 –</b>
--	--------------------------	--------------

Negative / Positive

	<b>80° Diamond Type</b>	<b>C20</b>	<b>C63</b>
---	-------------------------	------------	------------

	<b>55° Diamond Type</b>	<b>C29</b>	<b>C70</b>
---	-------------------------	------------	------------

	<b>Round Type</b>		<b>C74</b>
---	-------------------	--	------------

	<b>Square Type</b>	<b>C37</b>	<b>C75</b>
---	--------------------	------------	------------

	<b>60° Triangular Type</b>	<b>C46</b>	<b>C80</b>
---	----------------------------	------------	------------

	<b>35° Diamond Type</b>	<b>C55</b>	<b>C90</b>
---	-------------------------	------------	------------

	<b>80° Trigon Type</b>	<b>C58</b>	<b>C94</b>
---	------------------------	------------	------------

	<b>CBN Inserts</b>	<b>M1 –</b>
---	--------------------	-------------

	<b>PCD Inserts</b>	<b>M1 –</b>
---	--------------------	-------------

	<b>Guidance</b>	<b>N1 –</b>
--	-----------------	-------------

 **Milling Cutters** G1-

 **Multi-Drills** K1-

 **Milling Cutters** G53-  
High Feed / Special Purpose Cutters

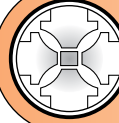
 **SumiBoron** L1-  
CBN Grades

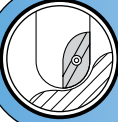
 **Indexable Endmills** H1-

 **SumiDia** L24-  
PCD Grades

 **Endmills** J1-  
Coated Solid Types

 **CBN / PCD** M1-  
Inserts and Tools

 **Endmills** J36-  
Uncoated Solid Types

 **Spare Parts** P1-

 **Index** P9-



## Dimension symbols are compliant with ISO13399

The following table shows ISO13399-compliant dimension symbols. Contents corresponding to the sample symbols/notations are shown below. Tool shape diagrams and stock charts use the symbols and notation examples from the table below.

### (1) Inserts (For Turning / For Milling)

Symbol	Description
<b>AN</b>	Clearance angle major
<b>APMX</b>	Depth of cut maximum
<b>BS</b>	Wiper edge length
<b>CDX</b>	Cutting depth maximum
<b>CHW</b>	Corner chamfer width
<b>CW</b>	Cutting width
<b>D1</b>	Fixing hole diameter
<b>DMIN</b>	Minimum bore diameter
<b>IC</b>	Inscribed circle diameter
<b>INSL</b>	Insert length
<b>L</b>	Cutting edge length
<b>PDX</b>	Profile distance ex
<b>PDY</b>	Profile distance ey
<b>PNA</b>	Profile included angle
<b>RE</b>	Corner radius
<b>RER</b>	Right side corner radius
<b>REL</b>	Left side corner radius
<b>S</b>	Insert thickness
<b>W1</b>	Insert width
<b>WF</b>	Functional width

### (2) Tool Holders For Turning

Symbol	Description
<b>APMX</b>	Depth of cut maximum
<b>B</b>	Shank width
<b>BD</b>	Body diameter
<b>CDX</b>	Cutting depth maximum
<b>CRKS</b>	Connection retention knob thread size
<b>DC</b>	Cutting diameter
<b>DCB</b>	Connection bore diameter
<b>DCON</b>	Connection diameter
<b>DCSFMS</b>	Contact surface diameter machine side
<b>DMIN</b>	Minimum bore diameter
<b>DMM</b>	Shank diameter
<b>DN</b>	Neck diameter
<b>GAMF</b>	Rake angle radial
<b>GAMP</b>	Rake angle axial
<b>H</b>	Shank height
<b>HBH</b>	Head bottom offset height
<b>HBKL</b>	Head back offset length
<b>HBKW</b>	Head back offset width
<b>HBL</b>	Head bottom offset length
<b>HF</b>	Functional height
<b>KDP</b>	Groove depth
<b>KWW</b>	Keyway width
<b>LF</b>	Functional length
<b>LH</b>	Head length
<b>LHD</b>	Head length
<b>LS</b>	Shank length
<b>LSCX</b>	Clamping length maximum
<b>LU</b>	Usable length
<b>LUX</b>	Usable length maximum
<b>WF</b>	Functional width

(Turning Insert Example)

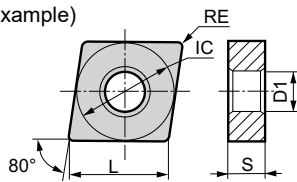

(Grooving Insert Example)

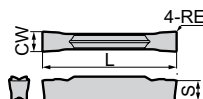

(External Holder Example)

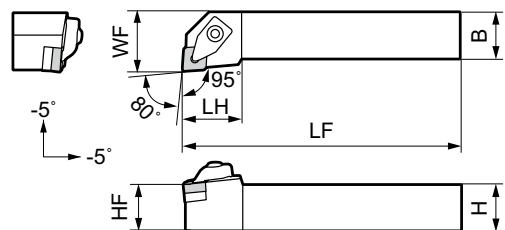
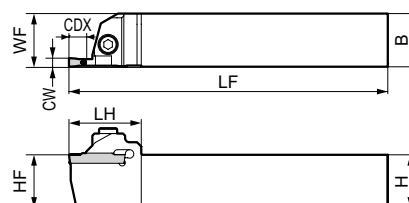

Figure shows right-handed tool.

(Grooving Tool Holder Example)



Notes: The symbols in the above table are compliant with ISO13399 and do not include symbols unique to our company. As symbols under review are not included, these may change over time.

### (3) Cutters / Indexable Endmills

Symbol	Description
<b>APMX</b>	Depth Of Cut Maximum
<b>BD</b>	Body Diameter
<b>BDX</b>	Body Diameter Maximum
<b>CBDP</b>	Connection Bore Depth
<b>CRKS</b>	Connection Retention Knob Thread Size
<b>CW</b>	Cutting Width
<b>DBC</b>	Connection Bore Diameter
<b>DC</b>	Cutting Diameter
<b>DCB</b>	Clamping Diameter, Nominal, on Workpiece Side
<b>DCON</b>	Connection Diameter
<b>DCSFMS</b>	Contact Surface Diameter Machine Side
<b>DCX</b>	Cutting Diameter Maximum
<b>DMM</b>	Shank Diameter
<b>DN</b>	Neck Diameter
<b>H</b>	Shank Height
<b>KDP</b>	Groove Depth
<b>KWW</b>	Keyway Width
<b>LBX</b>	Body Length Maximum
<b>LF</b>	Functional Length
<b>LH</b>	Head Length
<b>LS</b>	Shank Length
<b>LU</b>	Usable Length
<b>OAL</b>	Overall Length
<b>RMPX</b>	Maximum Ramping Angle
<b>THUB</b>	Hub Thickness

(Shell Type Example)

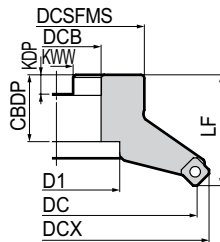

(Shank Type Example)

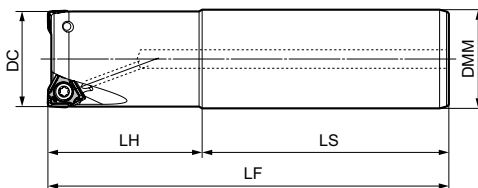

(Modular Type Example)

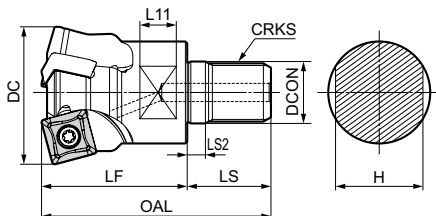

### (4) Endmills

Symbol	Description
<b>APMX</b>	Depth Of Cut Maximum
<b>CHW</b>	Corner Chamfer Width
<b>DC</b>	Cutting Diameter
<b>DMM</b>	Shank Diameter
<b>DN</b>	Neck Diameter
<b>LF</b>	Functional Length
<b>LFS</b>	Functional Length Secondary
<b>LU</b>	Usable Length
<b>RE</b>	Corner Radius

### (5) Drills / Reamers

Symbol	Description
<b>BD</b>	Body Diameter
<b>BDX</b>	Body Diameter Maximum
<b>CW</b>	Cutting Width
<b>DC</b>	Cutting Diameter
<b>DCB</b>	Clamping Diameter, Nominal, on Workpiece Side
<b>DCON</b>	Connection Diameter
<b>DCSFMS</b>	Contact Surface Diameter Machine Side
<b>DF</b>	Flange Diameter
<b>DMM</b>	Shank Diameter
<b>LBX</b>	Body Length Maximum
<b>LCF</b>	Length Chip Flute
<b>LF</b>	Functional Length
<b>LFA</b>	A Dimension On Lf
<b>LFS</b>	Functional Length Secondary
<b>LH</b>	Head Length
<b>LPR</b>	Protruding Length
<b>LS</b>	Shank Length
<b>LU</b>	Usable Length
<b>LUX</b>	Usable Length Maximum
<b>OAL</b>	Overall Length
<b>PL</b>	Point Length
<b>WBTHK</b>	Web Thickness

(Endmill Example)

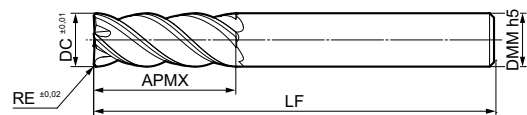

(Drill Example)

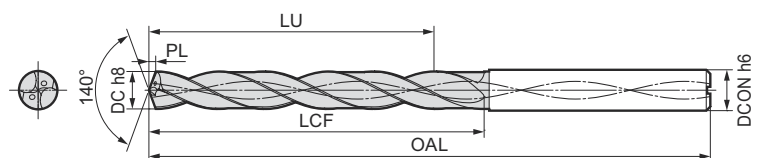



## Notice

Thank you for using the Sumitomo Electric Hardmetal General Catalogue  
(Sumitomo/SUMIBORON/SUMIDIA Cutting Tools Catalogue).

This catalogue presents the major items in the Sumitomo Cutting Tools product line.

The catalogue is organised as follows:

- (1) Cutting Tool Grades
- (2) Sumitomo Products
- (3) SUMIBORON, SUMIDIA Products

Ask for our brochures and pamphlets.

This catalogue is current as of January 2022.

As a result of our ongoing research, product may reflect enhancements in quality, performance and specifications not listed in this catalogue.

To order Sumitomo/SUMIBORON/SUMIDIA products, contact your nearest Sumitomo Electric Hardmetal dealer or distributor.

For inquiries or other requests, feel free to contact your nearest sales office.

## Stock Marking Chart

● : Euro stock item

○ : Japan stock item

□ : Delivery on request

▲ : To be replaced by new item

□ : Made to order item

— : We cannot produce

**Note:**

Stocking policy may change without prior notice, please consult our sales representative for actual stock situation.

## Meaning of Icons

### Common



Featured for the first time in this catalogue



Newly added to expand our selection of items

### Grade

ISO classification of work material:



Steel



Stainless Steel



Cast Iron



Non Ferrous Alloy



Exotic Alloy



Hardened Steel

### Endmill

Shape



Sharp edge



Corner with honing



Helix angle (ex.)



Radius



Ballnose

No. of teeth



Flutes

### Milling Cutter

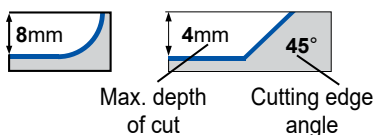
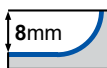

Max. depth of cut

Cutting edge angle

# Insert Selection

# A



**A1–A20**



Insert Selection

Insert Selection

<b>Sumitomo Grades (Turning)</b> .....	A2
<b>Sumitomo Grades (Milling)</b> .....	A3

Chipbreaker and Grade Selection

<b>Steel Turning Inserts</b> .....	A 4–7
<b>Stainless Steel Turning Inserts</b> .....	A 8–9
<b>Cast Iron Turning Inserts</b> .....	A10–11
<b>Exotic Alloy Inserts</b> .....	A12–13
<b>Hardened Steel Turning Inserts</b> .....	A14–15
<b>Non-Ferrous Metal Turning Inserts</b> .....	A16–17
<b>Small Product Machining</b> .....	A18–19



# Selection of Sumitomo Grades (Turning)

Insert Selection

Work Material	<b>P General Steel (Carbon Steel, Alloy Steel), Soft Steel</b>						<b>M Stainless Steel</b>						<b>K Cast Iron</b>				
	Wear Resistance ← Fracture Resistance						Wear Resistance ← Fracture Resistance						Wear Resistance ← Fracture Resistance				
Classification	Q	P01	P10	P20	P30	P40	Q	M01	M10	M20	M30	M40	Q	K01	K10	K20	K30
Coated Carbide			AC8015P						AC6020M						AC4010K		
		New	AC8020P						AC6030M						AC4015K		
Small Product Machining			AC8025P						AC6040M						AC420K		
				AC8035P					AC630M								AC8025P
Coated Cermet			AC1030U						AC1030U						AC1030U		
			AC530U						AC530U						AC530U		
Cermet			T1500Z														
		New	T2500Z														
Carbide			T1000A						T1000A						T1000A		
			T1500A						T1500A								
Uncoated CBN Coated CBN			T2500A												G10E		
															BN7000		
																New	BNC8115
																New	BNS8125
																	BNC500

Work Material	<b>S Exotic Alloy</b>					<b>H Hardened Steel</b>				Work Material	<b>N Non-Ferrous Metal</b>				
	Wear Resistance ← Fracture Resistance					Wear Resistance ← Fracture Resistance					Wear Resistance ← Fracture Resist.				
Classification	Q	S01	S10	S20	S30	Q	H01	H10	H20	H30	Q	N01	N10	N20	N30
Coated Carbide		New	AC5005S												H1
			AC5015S					AC503U					DA90		
Carbide			AC5025S										DA150		
			EH510										DA1000		
Coated CBN			EH520												
								BNC2010							
Uncoated CBN								BNC2020		BNC300					
								New	BNC2125						
								New	BNC2115						
Powdered Metal								BN1000							
								BN2000							
Cemented Carbides and Hard Brittle Materials										BNX20					
										BN350					
Coated Carbide															
Cermet															
Uncoated CBN															
PCD															

# Selection of Sumitomo Grades (Milling)

Insert Selection

Work Material	<b>P General Steel (Carbon Steel, Alloy Steel), Soft Steel</b>						<b>M Stainless Steel</b>						<b>K Cast Iron</b>				
	Wear Resistance ← Fracture Resistance						Wear Resistance ← Fracture Resistance						Wear Resistance ← Fracture Resistance				
	Q	P01	P10	P20	P30	P40	Q	M01	M10	M20	M30	M40	Q	K01	K10	K20	K30
Coated Carbide																	
Cermet																	
Carbide																	
Uncoated CBN Coated CBN																	

Work Material	<b>S Exotic Alloy</b>						<b>H Hardened Steel</b>					<b>N Non-Ferrous Metal</b>				
	Wear Resistance ← Fracture Resistance						Wear Resistance ← Fracture Resistance					Wear Resistance ← Fracture Resistance				
	Q	S01	S10	S20	S30	S40	Q	H01	H10	H20	H30	Q	N01	N10	N20	N30
Coated Carbide																
Carbide																
Uncoated CBN																
PCD																



### Main Chipbreakers

#### Negative Type

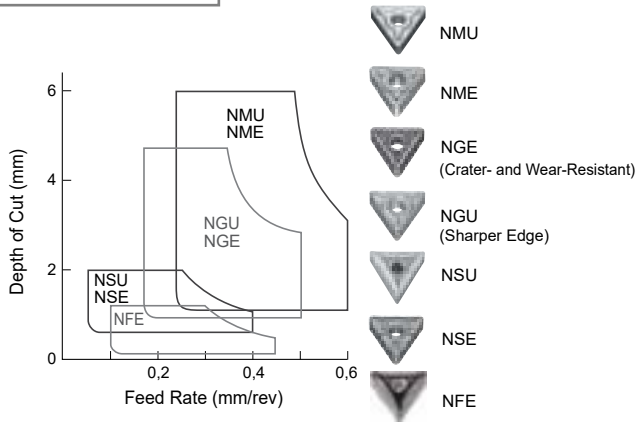

#### Positive Type

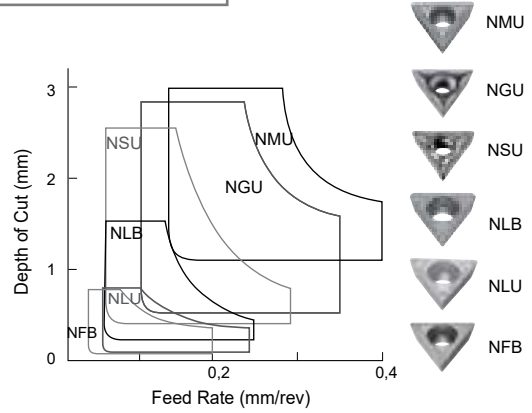

### Sub-Chipbreakers

#### Negative Type

##### Chipbreakers for High-Efficiency Machining

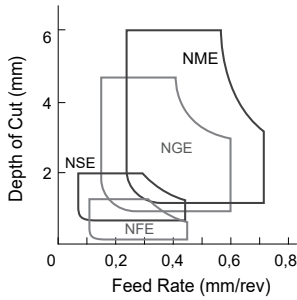

##### Strong Edge Chipbreakers

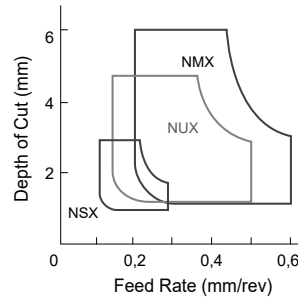

##### Chipbreakers for Small Depths

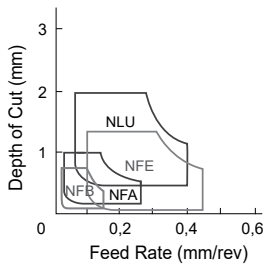

##### Wiper Inserts

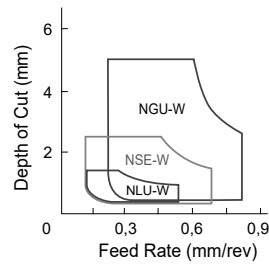

##### Chipbreakers for Heavy Cutting

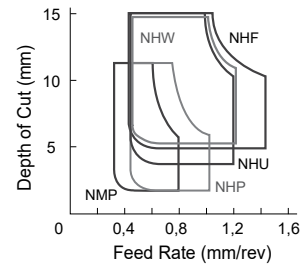

### Grades

#### Fine Finishing to Finishing

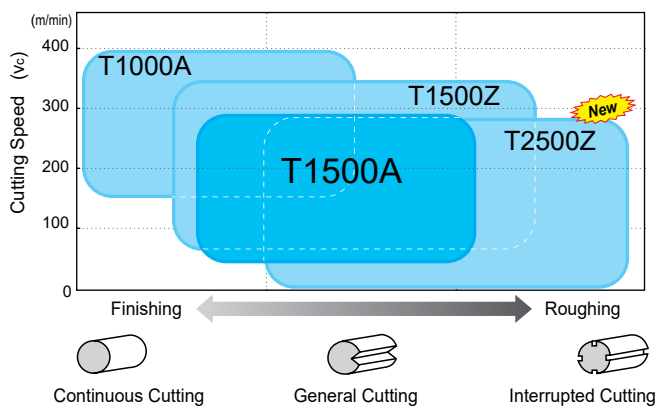

#### Finishing to Rough Cutting

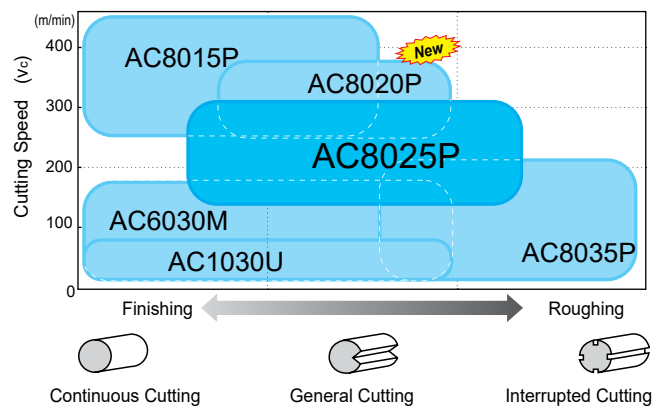

Uncoated Cermet Coated Cermet New  
**T1000A / T1500A / T1500Z / T2500Z**

**Grades**

- T1000A** High-hardness cermet with outstanding wear resistance and toughness. Realises high dimensional accuracy for continuous steel machining or finishing of Sintered Alloy or cast iron.
- T1500A** General-purpose cermet made from hard grains with different grain sizes, delivering functionality that provides an excellent balance of wear resistance and toughness. Also achieves good surface finish quality.
- T1500Z** Employs Brilliant Coat PVD coating with excellent lubricity to provide better wear resistance and consistent surface finishes in low-speed cutting applications such as machining of small products or low carbon steel.
- T2500Z** A new cermet substrate with excellent thermal conductivity is used to achieve outstanding thermal crack resistance. Also uses Brilliant Coat, which has excellent lubricity.

**Performance**

**T1000A**

**Wear Resistance**

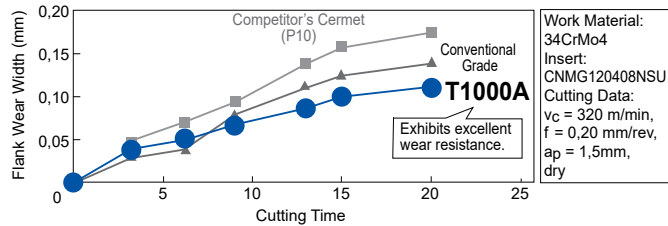

**Fracture Resistance**

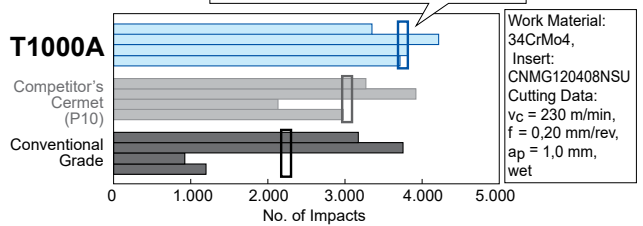

**T1500A**

**Wear Resistance**

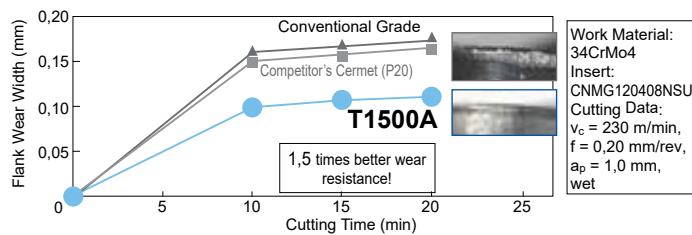

**Machined Surface Finish**

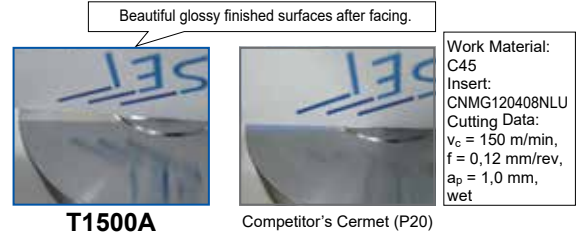

**T1500Z**

**Wear Resistance**

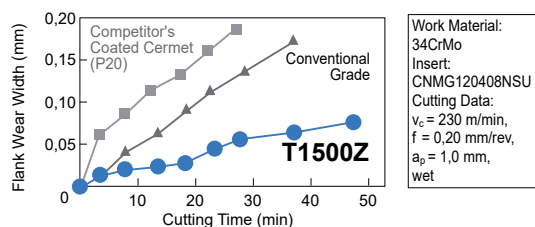

**Machined Surface Finish**

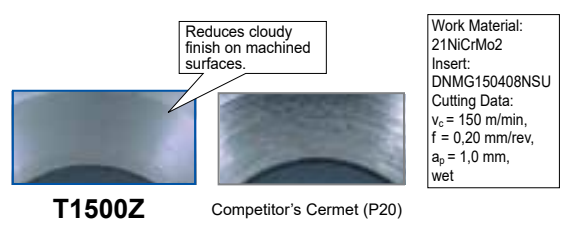

**T2500Z**

**Wear Resistance**

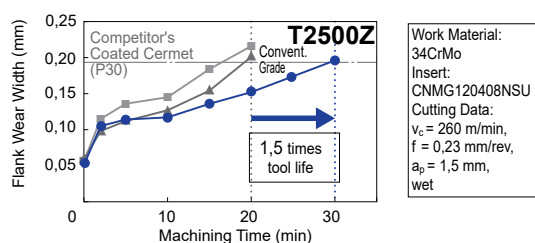

**Fracture Resistance**

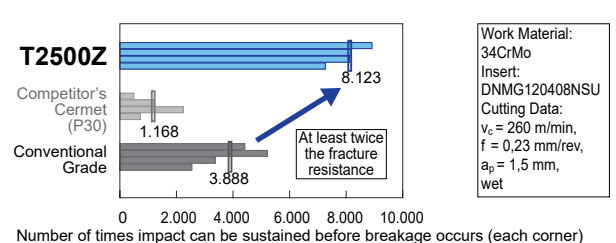

**P Recommended Cutting Conditions**

(Min. - Optimum - Max.)

Work Material	Cutting Process	Chipbreaker	Grades	Depth of Cut (mm)	Feed Rate (mm/rev)	Cutting Speed (m/min)
Soft Steel	Fine Finishing	NFA / NFL	T1500Z	0,2–0,5–1,0	0,05–0,15–0,25	150–280–400
	Finishing	NLU	T3000Z	0,3–1,0–1,8	0,08–0,20–0,35	150–280–400
Alloy Steel Carbon Steel	Fine Finishing	NFA / NFL	T1500A	0,2–0,5–1,0	0,05–0,15–0,25	100–200–300
	Finishing	NSU / NSE	T1500A	0,5–1,0–2,0	0,08–0,20–0,35	100–200–300
	Medium	NGU	T1500Z	0,8–2,2–4,0	0,15–0,25–0,50	100–200–300
High Carbon Steel Carbon Steel	Fine Finishing	NFA / NFL	T1000A	0,2–0,5–1,0	0,05–0,15–0,25	50–150–250
	Finishing	NSU / NSE	T1500Z	0,5–1,0–2,0	0,08–0,20–0,35	50–150–250
	Medium	NGU	T1500Z	0,8–2,2–4,0	0,15–0,25–0,50	50–150–250

ABSOTECH

ABSOTECH

**New**

ABSOTECH

ABSOTECH

ABSOTECH

### Grades

**AC8015P / AC8020P / AC8025P / AC8035P / AC1030U**

Covers a wide range of machining applications from high-speed cutting to interrupted cutting and small lathe machining.

- AC8015P** Development of crater damage is suppressed by controlling the orientation of the alumina crystal grains. Achieves long, stable tool life during high-speed and high feed cutting.
- AC8020P** Alumina coating with even higher strength balances outstanding stability and wear resistance in mill-scale work on forged material. Gold-colored coating makes used corners easily identifiable.
- AC8025P** The 1st recommendation grade for turning steel. Surface smoothing technology significantly suppresses adhesion of work material components. Achieves long, stable tool life with various cutting speeds and work materials.
- AC8035P** Tensile stress removal of the coating layer greatly improves fracture resistance. Achieves long, stable tool life during heavy interrupted cutting.
- AC1030U** Employs a new PVD coating and a dedicated tough carbide substrate. High-quality cutting edge grade suppresses adhesion and micro-chipping, realizing excellent machined surface quality.

### Performance

#### AC8015P

Alumina crystal grain orientation control technology suppresses crater damage due to chip abrasion.

<p><b>Conventional Tool</b></p> <p>5 min TiCN layer exposed</p> <p>14 min End of tool life</p> <p>Crater damage progression due to peeling of alumina layer.</p> <p>Work Material: 100Cr6 //(external continuous) Insert: CNMG120408NGU Cutting Data: <math>v_c = 300</math> m/min, <math>f = 0,3</math> mm/rev, <math>a_p = 1,5</math> mm, wet</p>	<p><b>AC8015P</b></p> <p>5 min Minor wear</p> <p>17 min TiCN layer exposed</p> <p>20 min End of tool life</p> <p>Suppresses crater damage due to chip abrasion</p> <p>Twice the crater wear resistance</p>
---	--

#### AC8020P

Alumina coating with even higher strength suppresses chipping.

<p><b>Conventional Tool</b></p> <p>400 impacts Minimal chipping</p> <p>1600 impacts Tool life</p> <p>Chipping</p> <p>Work Material: 34CrMo4 //(incl. intermittent forge sections) Insert: CNMG120408NGU Cutting Data: <math>v_c = 250</math> m/min, <math>f = 0,3</math> mm/rev, <math>a_p = 1,5</math> mm, wet</p>	<p><b>AC8020P</b></p> <p>400 impacts Minor damage</p> <p>1600 impacts Minor damage</p> <p>4000 impacts Minimal chipping</p> <p>Balance of high wear resistance and stability</p> <p>2,5x chipping resistance or more</p>
---	--

#### AC8025P

Surface smoothing treatment significantly suppresses adhesion and chipping.

<p><b>Conventional Tool</b></p> <p>2 min Adhesion</p> <p>70 min Chipping</p> <p>Unable to continue</p> <p>Work Material: 15CrMo5 (Face) Insert: CNMG120408NGU Cutting Data: <math>v_c = 100-300</math> m/min, <math>f = 0,3</math> mm/rev, <math>a_p = 1,5</math> m, wet</p>	<p><b>AC8025P</b></p> <p>2 min Normal wear</p> <p>70 min Minor damage only, able to continue</p> <p>120 min Minor damage only, able to continue</p> <p>Suppresses adhesion with ultra-smooth surface</p> <p>Twice the adhesion fracture resistance</p>
--	--

#### AC8035P

Special surface treatment reduces tensile stress in the coating layer, significantly suppressing breakages.

<p><b>Conventional Tool</b></p> <p>Feed Rate (mm/rev) vs. No. of Impacts</p> <p>Unable to continue</p> <p>Work Material: 34CrMo4 (external interrupted) Insert: CNMG120408NGU Cutting Data: <math>v_c = 160</math> m/min, <math>f = 0,2-0,3</math> mm/rev, <math>a_p = 2,0</math> mm, dry</p>	<p><b>AC8035P</b></p> <p>Feed Rate (mm/rev) vs. No. of Impacts</p> <p>All corners able to continue</p> <p>Suppresses crack growth and breakages by reducing tensile stress</p> <p>Twice the fracture resistance</p>
---	---

## Grades and Chip breaker Selection Guide

1st Recommended Grade	
General Purpose	<b>AC8025P</b>



1st Recommendation
<b>NGU</b>

	Chipbreakers for High-efficiency Machining		Main Chipbreakers		Strong Cutting Edge Chipbreakers	
Finish – Small Depth	<b>NFE</b> 	<b>NSE</b> 	<b>NSU</b> 	<b>NSX</b> 		
General Purpose	<b>NGE</b> 		<b>NGU</b> 	<b>NUX</b> 		
Rough – Larger Cutting Depth	<b>NME</b> 		<b>NMU</b> 	<b>NMX</b> 		

For High-speed Continuous Machining of Mild Steel

High Speed **AC8015P**

To improve tool life at small depths of cut	<b>NFE</b> 
To improve finishing efficiency	<b>NSE</b> 

For Heavy Interrupted Cutting Emphasizing Stability

Interrupted Cut **AC8035P**

To improve tool life	<b>NGU</b> 
To improve machining stability	<b>NUX</b> 

For High-efficiency Machining of High Carbon Steel and Forged Steel

High Efficiency **AC8020P**

To increase feed rate	<b>NGE</b> 
-----------------------	----------------

To increase cutting speed	<b>NGU</b> 
---------------------------	----------------

## P Recommended Cutting Conditions

(Min. - Optimum - Max.)

Work Material	Cutting Process	Chipbreaker	Grade	Depth of Cut (mm)	Feed Rate (mm/rev)	Cutting Speed (mm/min)
Soft Steel Low Carbon Steel (SS400, C15, etc.)	Fine Finishing	NFB, NFE	T1500Z	0,2–0,6–1,0	0,05–0,15–0,25	100–250–400
	Continuous	NGU, NGE	AC8015P	1,0–2,5–4,0	0,1–0,25–0,4	260–350–440
	General-Interrupted	<b>NGU, NGE</b>	<b>AC8025P</b>	1,0–2,5–4,0	0,2–0,35–0,5	200–260–320
	Heavy Interrupted	NMU, NME	AC8035P	1,5–4,0–6,0	0,3–0,45–0,6	140–150–220
Medium to High Carbon Steel Alloy Steel, Hard Steel (C45, 34CrMo4, etc.)	Fine Finishing	NFB, NFE	T1500Z	0,2–0,6–1,0	0,05–0,15–0,25	50–200–300
	Continuous-General	<b>NGU, NGE</b>	<b>AC8020P</b>	1,0–2,5–4,0	0,2–0,35–0,5	150–235–290
	Interrupted	NGU, NGE	AC8025P	1,0–2,5–4,0	0,2–0,35–0,5	130–165–230
	Heavy Interrupted	NMU, NME	AC8035P	1,5–4,0–6,0	0,3–0,45–0,6	90–135–160



### Chipbreakers

#### Negative Type

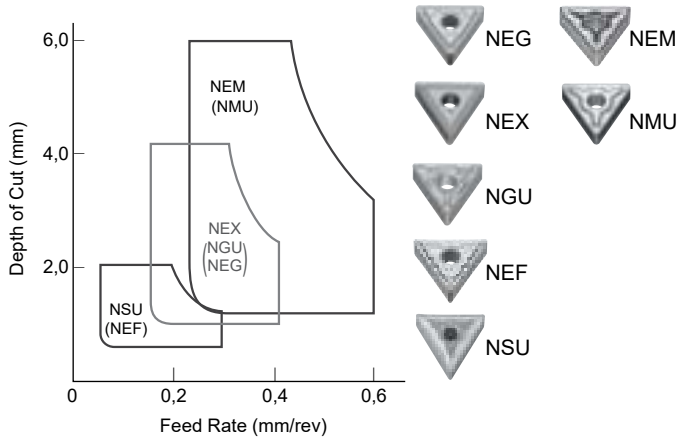

#### Positive Type

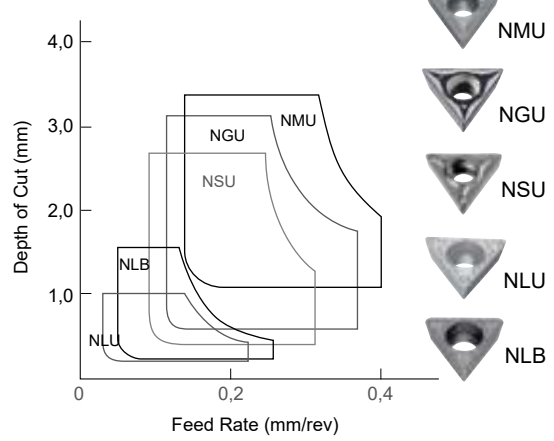

### Grades

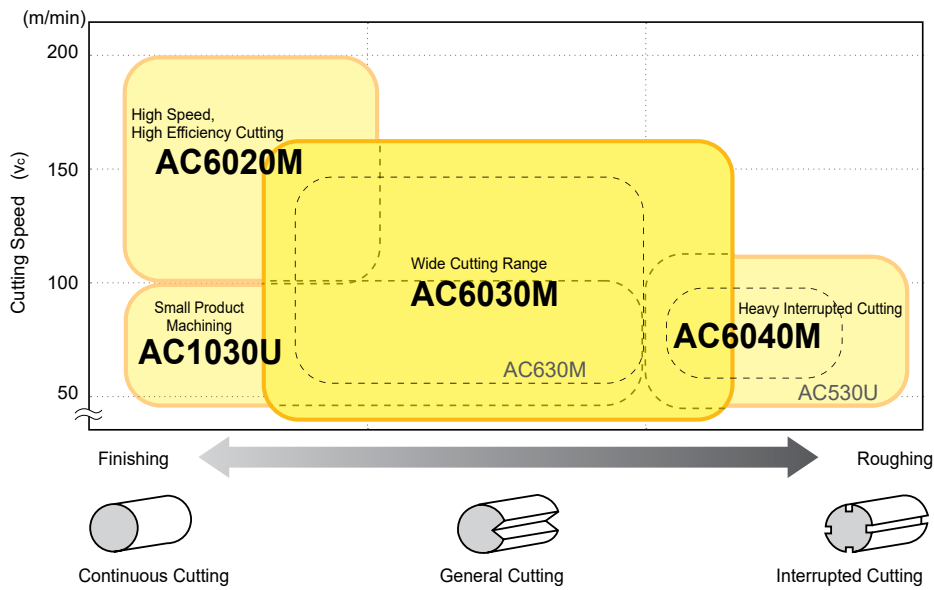

### M Recommended Cutting Conditions

(Min. - Optimum - Max.)

Work Material			Cutting Range	Chipbreaker	Grade	Cutting Conditions		
						Depth of Cut $a_p$ (mm)	Feed Rate $f$ (mm/rev)	Cutting Speed $v_c$ (m/min)
Cr-Based	Ferritic Materials	X6CrAl 13, X8CrNiS 18 9, X29CrS 13, X6CrMoS 17, X12CrS 13	Finishing	NEF (NSU)	AC6020M	0,5-1,5-2,0	0,05-0,15-0,25	170-230-300
			Medium	NEG · NGU · NEX	AC6030M	1,0-2,5-4,0	0,10-0,25-0,40	140-170-250
			Roughing	NEM	AC6040M	1,5-3,5-6,0	0,20-0,35-0,60	140-170-200
	Martensitic Materials	X12Cr 13, X20Cr 13, X30Cr 13, X6Cr 17, X19CrNi 17 2, X6CrNi 18 9	Finishing	NEF (NSU)	AC6020M	0,5-1,5-2,0	0,05-0,15-0,25	120-180-240
			Medium	NEG · NGU · NEX	AC6030M	1,0-2,5-4,0	0,10-0,25-0,40	100-150-200
			Roughing	NEM	AC6040M	1,5-3,5-6,0	0,20-0,35-0,60	80-130-180
Cr/Ni-Based	Austenitic Materials	X5CrNi 18 10, X2CrNi 19 11, X2CrNiMo 18 10, X4CrNiMo 17 12 2, X2CrNiMo 17 12 2, X5CrNiMo 17 13, X6CrNiTi 18 10, X7CrMo 15	Finishing	NEF (NSU)	AC6020M	0,5-1,5-2,0	0,05-0,15-0,25	120-180-240
			Medium	NEG · NGU · NEX	AC6030M	1,0-2,5-4,0	0,10-0,25-0,40	100-150-200
			Roughing	NEM	AC6040M	1,5-3,5-6,0	0,20-0,35-0,60	80-130-180
	Two-Phase (Austenite / Ferrite) Materials	X5CrNi 17 7, X2CrNi 18 9, X6CrNi 25 20, X2CrNiMoN 17 12 2, X6CrNiNb 18 10	Finishing	NEF (NSU)	AC6030M	0,5-1,5-2,0	0,05-0,15-0,25	100-145-180
			Medium	NEG · NGU · NEX	AC6030M	1,0-2,5-4,0	0,10-0,25-0,40	80-120-160
			Roughing	NEM	AC6040M	1,5-3,5-6,0	0,20-0,35-0,60	70-100-140
	Precipitation Hardening	X5CrNiCuNb 16 4, X7CrNiAl 17 7, X4CrNiMo 27 5 2, X2CrNiMoN 22 5 3, X2CrNiMoCuN 25 6 3	Finishing	NEF (NSU)	AC6030M	0,5-1,5-2,0	0,05-0,15-0,25	90-115-140
			Medium	NEG · NGU · NEX	AC6030M	1,0-2,5-4,0	0,10-0,25-0,40	70-90-110
			Roughing	NEM	AC6040M	1,5-3,5-6,0	0,20-0,35-0,60	50-80-120

### Grades

**ABSOTECH** **ABSOTECH** **ABSOTECH** **ABSOTECH**  
**AC6020M / AC6030M / AC6040M / AC1030U**

- AC6020M** Employs "Absotech Platinum", a new CVD coating. The first recommended grade for continuous stainless steel machining that achieves a good balance between wear resistance and fracture resistance by combining a hardened substrate with excellent wear resistance.
- AC6030M** Employs "Absotech Platinum", a new CVD coating. The first recommended grade for general machining of stainless steel that drastically reduces the occurrence of abnormal damage, which is a problem in stainless steel machining. Achieves long and stable machining thanks to the improved coating strength and excellent adhesion.
- AC6040M** Employs "Absotech Bronze", a new PVD coating and exclusive tough carbide substrate. The first recommended grade for interrupted machining of stainless steel that drastically improves the reliability in unstable machining thanks to the excellent adhesion and peel-off resistance of the new PVD coating as well as the improved fracture resistance of the exclusive carbide substrate.
- AC1030U** Employs "Absotech Bronze", a new PVD coating with a special tough carbide substrate. Achieving excellent machined surface quality with a high-quality cutting edge that reduces adhesion and micro-chipping.

### Performance

#### AC6020M

##### Continuous Cutting (Medium Speed)

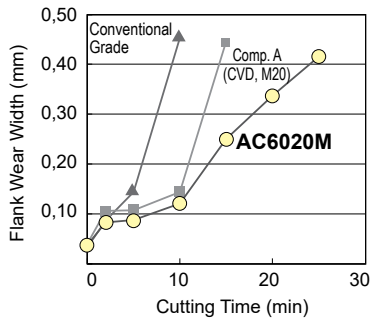

Work Material: X2CrNiMo17 13 2    Insert: CNMG 120408 NGU  
 Cutting Conditions:  $v_c = 150$  m/min,  $f = 0,3$  mm/rev,  $a_p = 2,0$  mm, wet

##### Continuous Cutting (High Speed)

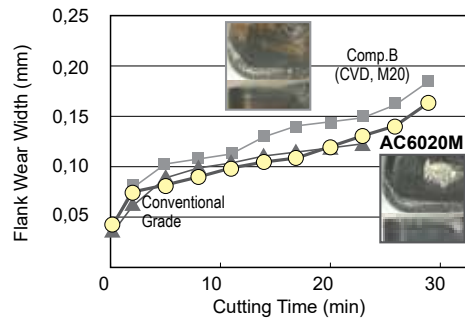

Work Material: X2CrNiMo17 13 2    Insert: CNMG 120408 NGU  
 Cutting Conditions:  $v_c = 200$  m/min,  $f = 0,3$  mm/rev,  $a_p = 2,0$  mm, wet

#### AC6030M

##### Continuous Cutting

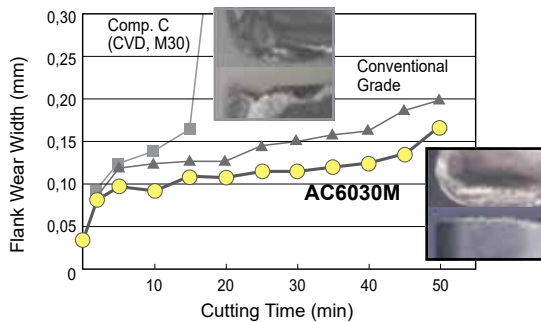

Work Material: X6CrMo17 12 2    Insert: CNMG 120408 NEX  
 Cutting Conditions:  $v_c = 200$  m/min,  $f = 0,2$  mm/rev,  $a_p = 2,0$  mm, wet

##### Interrupted Cutting

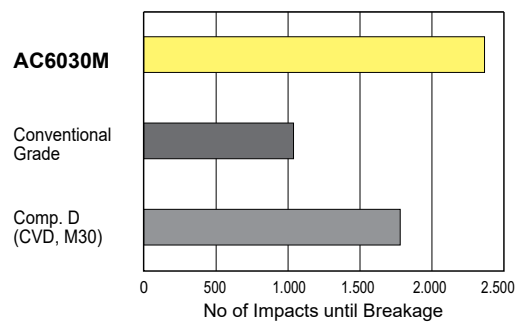

Work Material: X6CrMo17 12 2    Insert: CNMG 120408 NGU  
 Cutting Conditions:  $v_c = 100$  m/min,  $f = 0,1$  mm/rev,  $a_p = 1,0$  mm, wet

#### AC6040M

##### Continuous Cutting

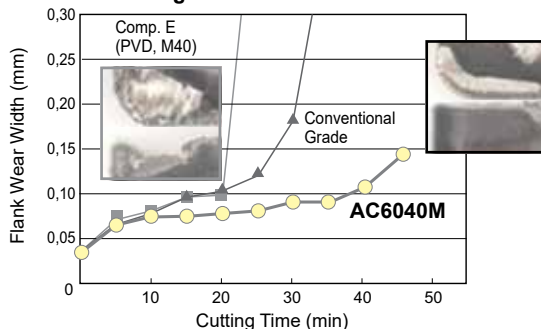

Work Material: X6CrMo17 12 2    Insert: CNMG 120408 NGU  
 Cutting Conditions:  $v_c = 150$  m/min,  $f = 0,2$  mm/rev,  $a_p = 2,0$  mm, wet

##### Interrupted Cutting

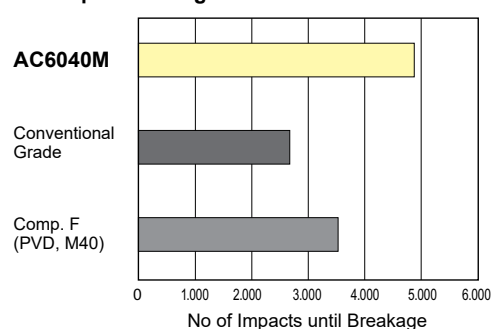

Work Material: CNMG 120408 NGU    Insert: CNMG 120408 NGU  
 Cutting Conditions:  $v_c = 230$  m/min,  $f = 0,23$  mm/rev,  $a_p = 0,80$  mm, dry

### Chipbreakers

#### Negative Type

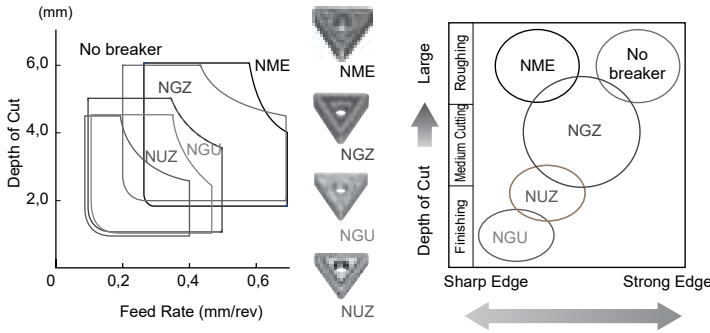

#### Positive Type

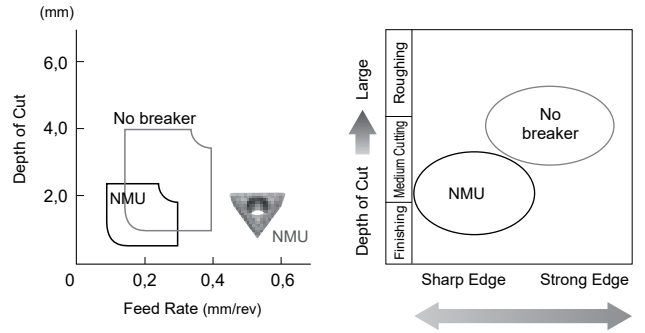

### Grades

#### Grey Cast Iron (GG)

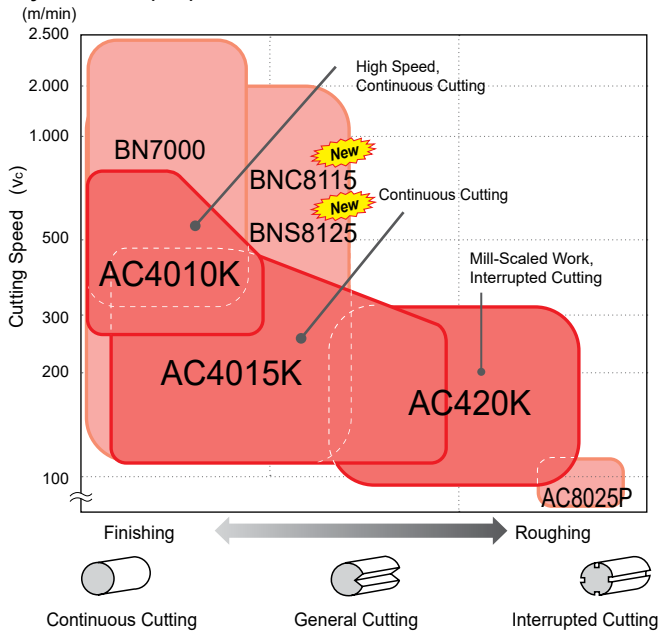

#### Ductile Cast Iron (GGG)

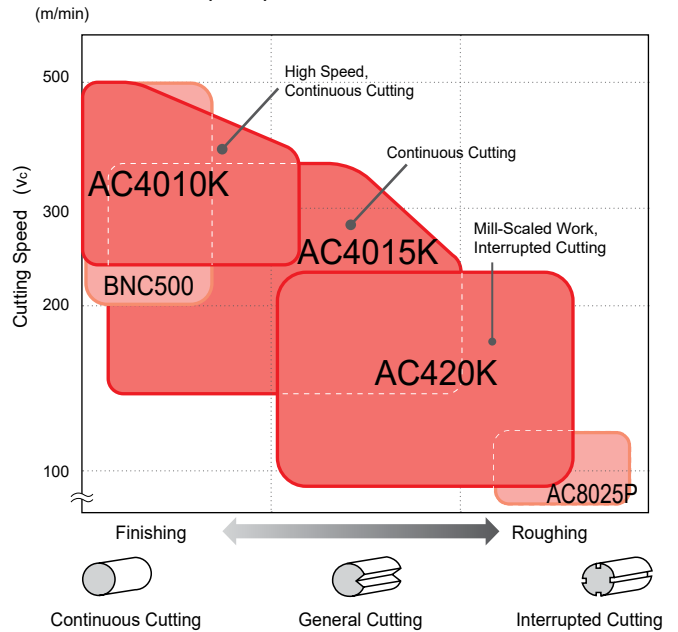

### Recommended Cutting Conditions

(Min. - Optimum - Max.)

Work Materials	Cutting Process	Grades	Cutting Conditions		
			Depth of Cut $a_p$ (mm/rev)	Feed Rate $f$ (mm/rev)	Cutting Speed $v_c$ (m/min)
Gray Cast Iron (GG-25, etc.)	High Speed Cutting	BN7000	0,1-0,3-1,0	0,10-0,20-0,50	500-1.500-2.000
	Continuous - General	AC4010K	0,5-2,0-6,0	0,10-0,25-0,40	200-400-700
		AC4015K	0,5-2,0-6,0	0,10-0,30-0,50	180-300-450
		AC420K	0,5-2,0-6,0	0,10-0,30-0,60	150-200-300
Ductile Cast Iron (GGG-40.3, etc.)	High Speed Cutting	BNC500	0,1-0,2-0,5	0,10-0,20-0,40	150-350-500
	Continuous - General	AC4010K	0,5-2,0-6,0	0,10-0,25-0,40	180-300-450
		AC4015K	0,5-2,0-6,0	0,10-0,30-0,50	160-250-400
		AC420K	0,5-2,0-6,0	0,10-0,30-0,60	120-170-250
High-strength Ductile Cast Iron (GGG-70, etc.)	High Speed Cutting	BNC500	0,1-0,2-0,5	0,10-0,20-0,40	200-350-500
	Continuous - General	AC4010K	0,5-2,0-6,0	0,10-0,25-0,40	160-250-400
		AC4015K	0,5-2,0-6,0	0,10-0,30-0,50	140-200-350
		AC420K	0,5-2,0-6,0	0,10-0,30-0,60	80-150-220



## Recommended Grades and Chipbreakers

### Grades



### AC4010K / AC4015K / AC420K

- AC4010K** The 1st recommended grade for machining grey cast iron. Adopts an ultra-thick new CVD coating to realise ultra-high-speed machining at  $V_c = 700$  m/min.
- AC4015K** The 1st recommendation grade for ductile cast iron. New high-adhesion, high-strength CVD coating realises both wear resistance and chipping resistance.
- AC420K** Superior fracture resistance, providing excellent stability in interrupted unstable cutting and when cutting mill-scaled work.



### Performance

#### AC4010K / AC4015K

##### Wear Resistance, Gray Cast Iron (GG)

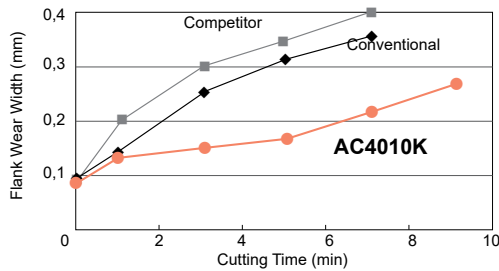

NGZ AC4010K      Conventional      Competitor

Work Material: GG-25, Continuous, Insert: CNMG120408  
Cutting Conditions:  $v_c = 600$  m/min,  $f = 0,4$  mm/rev,  $a_p = 2,0$  mm, dry

##### Wear Resistance, Ductile Cast Iron (GGG)

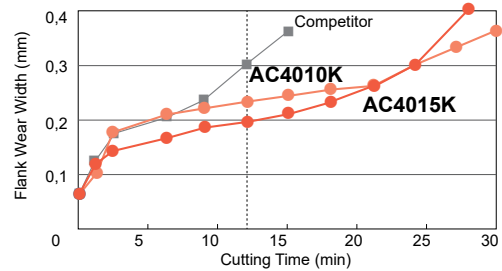

NGZ AC4010K      NGZ AC4015K      Competitor

Work Material: GGG-70, Continuous, Insert: CNMG120408  
Cutting Conditions:  $v_c = 140$  m/min,  $f = 0,3$  mm/rev,  $a_p = 1,5$  mm, wet

#### AC4010K / AC4015K

##### Chipping Resistance, Gray Cast Iron (GG)

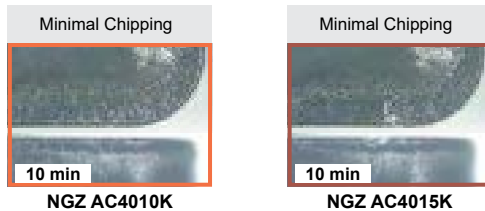

NGZ AC4010K

NGZ AC4015K

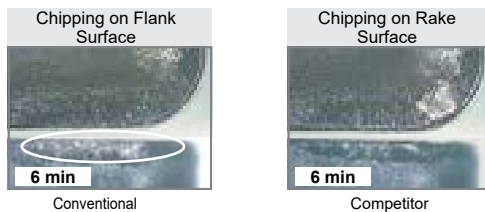

Conventional

Competitor

Work Material: GG-25, Interrupted, Insert: CNMG120408  
Cutting Conditions:  $v_c = 400$  m/min,  $f = 0,3$  mm/rev,  $a_p = 2,0$  mm, wet

##### Chipping Resistance, Ductile Cast Iron (GGG)

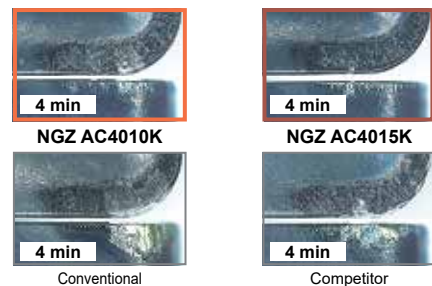
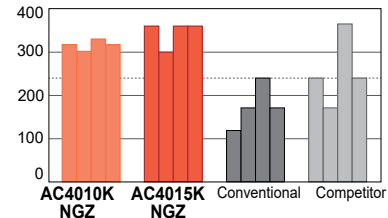

NGZ AC4010K

NGZ AC4015K

Conventional

Competitor

Work Material: GGG-40.3, Interrupted, Insert: CNMG120408  
Cutting Conditions:  $v_c = 450$  m/min,  $f = 0,3$  mm/rev,  $a_p = 1,5$  mm, wet

#### AC420K Fracture Resistance

##### GGG-40.3 Grooved (Heavy Interrupted Acceleration Test)

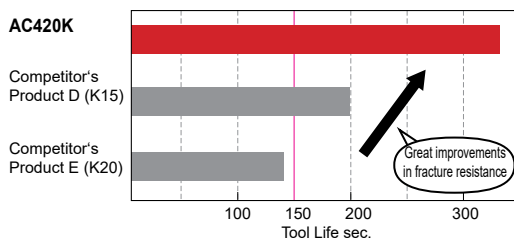

Great improvements in fracture resistance

##### Edge Wear Comparison (After 150s)



AC420K

Competitor's Product D (K15)

Competitor's Product E (K20)

Work Material: GGG-40.3, Toolholder: PCLNR2525-43 Insert: CNMG120408  
Cutting Conditions:  $v_c = 350$  m/min,  $f = 0,25$  mm/rev,  $a_p = 1,5$  mm, wet

### Chipbreakers

#### Negative Type

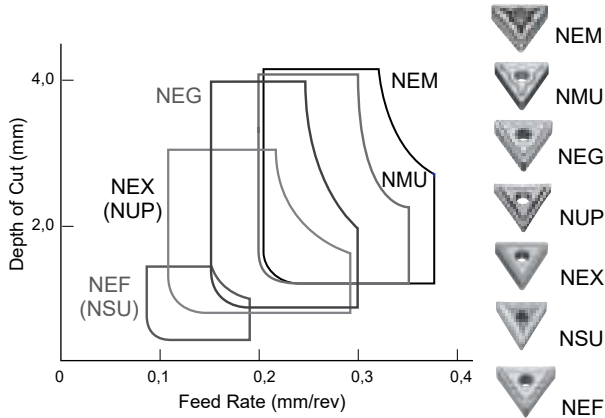

#### Positive Type

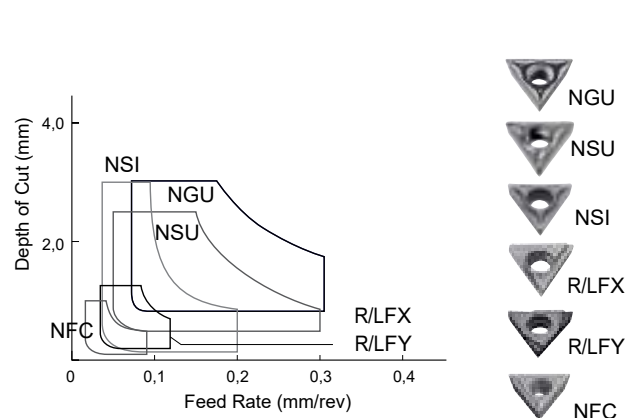

### Grades

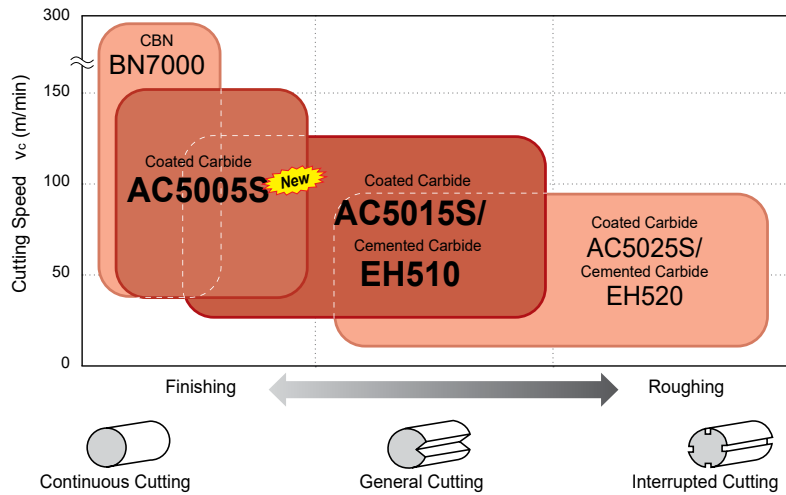

### S Recommended Cutting Conditions

(Min. - Optimum - Max.)

Work Material	Cutting Process	Chipbreakers	Grades	Depth of Cut (mm)	Feed Rate (mm/rev)	Cutting Speed (m/min)
Heat-Resistant Alloy	Finishing	NEF (NSU)	AC5005S <b>AC5015S</b> AC5025S	0,2- <b>0,5</b> -1,5	0,10- <b>0,12</b> -0,20	50- <b>70</b> -110
	Light	NEX	AC5005S <b>AC5015S</b> AC5025S	0,5- <b>1,0</b> -3,0	0,10- <b>0,20</b> -0,30	40- <b>60</b> -90
	Medium	NEG	AC5005S <b>AC5015S</b> AC5025S	0,5- <b>2,0</b> -4,0	0,15- <b>0,25</b> -0,30	40- <b>60</b> -90
	Rough	NMU/NEM	<b>AC5015S</b> AC5025S	1,0- <b>2,0</b> -4,0	0,20- <b>0,25</b> -0,40	30- <b>55</b> -80
Titanium Alloy	Finishing	NEF (NSU)	<b>EH510</b> (AC5005S, AC5015S)	0,2- <b>0,5</b> -1,5	0,10- <b>0,15</b> -0,20	50- <b>65</b> -80
	Light	NEX	AC5005S AC5015S	0,5- <b>1,0</b> -2,5	0,10- <b>0,20</b> -0,25	40- <b>55</b> -70
	Medium Rough	NEG	<b>EH510</b> (AC5005S, AC5015S)	0,5- <b>2,0</b> -3,5	0,15- <b>0,25</b> -0,30	40- <b>55</b> -70
		NMU/NEM	AC5025S	1,0- <b>2,0</b> -3,5	0,20- <b>0,25</b> -0,30	30- <b>40</b> -50



### Grades

**ABSOTECH** <sup>New</sup> **ABSOTECH** **ABSOTECH**  
**AC5005S / AC5015S / AC5025S / EH510 / EH520**

PVD grade with excellent wear and thermal resistance.

**AC5005S** High-speed, high-efficiency grade with great high-temperature strength, which realises excellent wear resistance in high-efficiency machining.

**AC5015S** The 1st recommended grade for turning exotic alloys as it realises stable tool life with high-speed, high-efficiency machining.

**AC5025S** High-toughness grade for realising stable tool life for interrupted cutting machining or mill-scaled work.

Carbides with excellent thermal, wear, and fracture resistance for use with exotic alloys. Lineup also includes new chipbreaker design.

**EH510** General purpose grade for titanium machining that features excellent wear and thermal resistance. For applications from roughing to finishing.

**EH520** Tough grade for titanium machining with excellent fracture and thermal resistance. Perfect for interrupted cutting and mill-scaled work.

### Performance

#### AC5005S

##### Wear Resistance (High-speed)

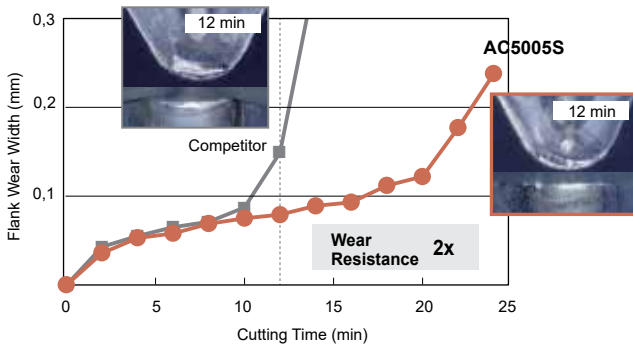

Work Material: Inconel 718 (44 HRC) Insert: DNMG150408 NEF  
 Cutting Conditions:  $v_c = 100$  m/min,  $f = 0,15$  mm/rev,  $a_p = 0,5$  mm, wet

##### Wear Resistance (High-feed)

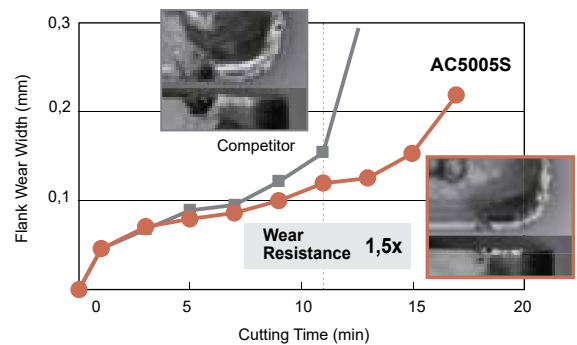

Work Material: Inconel 718 (44 HRC) Insert: CNMG120408 NEG  
 Cutting Conditions:  $v_c = 50$  m/min,  $f = 0,25$  mm/rev,  $a_p = 1,2$  mm, wet

#### AC5015S

##### Wear Resistance

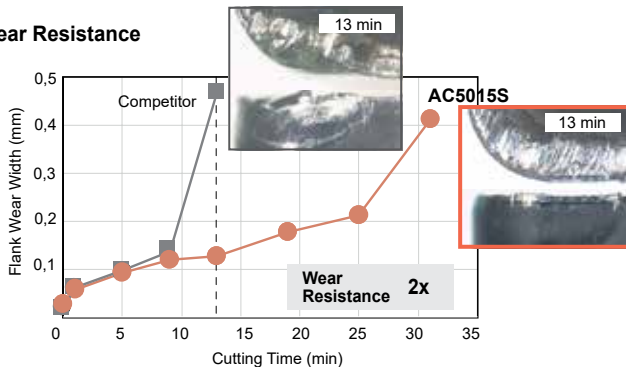

Work Material: Inconel 718 (44 HRC) Insert: CNMG120408 NEX  
 Cutting Conditions:  $v_c = 40$  m/min,  $f = 0,1$  mm/rev,  $a_p = 1,5$  mm, wet

##### Fracture Resistance

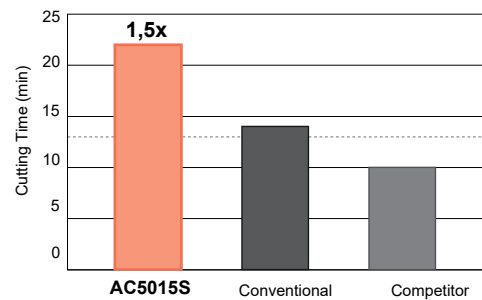

Work Material: Hastelloy (22 HRC), Insert: CNMG120408 NEX  
 Cutting Conditions:  $v_c = 50$  m/min,  $f = 0,1$  mm/rev,  $a_p = 1,5$  mm, wet

#### AC5025S

##### Wear Resistance

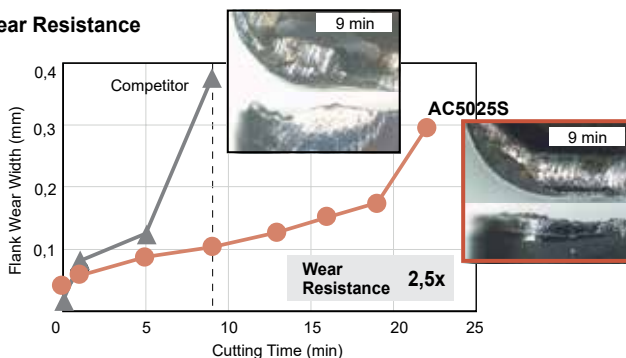

Work Material: Inconel 718 (44 HRC) Insert: CNMG120408 NEX  
 Cutting Conditions:  $v_c = 40$  m/min,  $f = 0,1$  mm/rev,  $a_p = 1,5$  mm, wet

##### Fracture Resistance

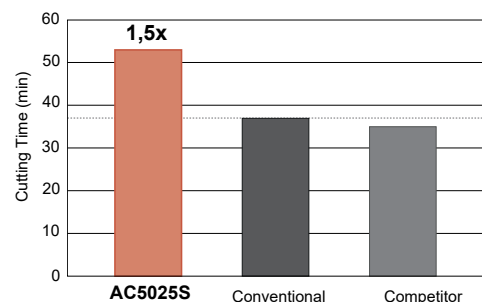

Work Material: Hastelloy (22 HRC), Insert: CNMG120408 NEX  
 Cutting Conditions:  $v_c = 50$  m/min,  $f = 0,1$  mm/rev,  $a_p = 1,5$  mm, wet

### Chipbreakers

NSV Type Chipbreaker: For chip control during carburized layer removal

NLV Type / NFV Type Chipbreaker: For chip control during finishing of hardened steel

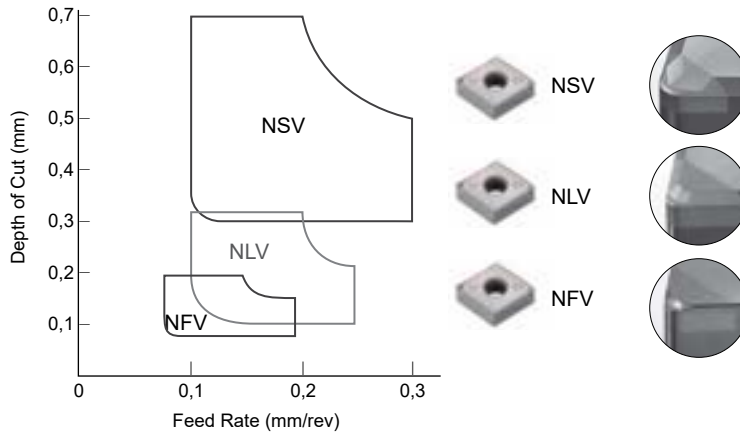

### Grades

#### Coated SUMIBORON

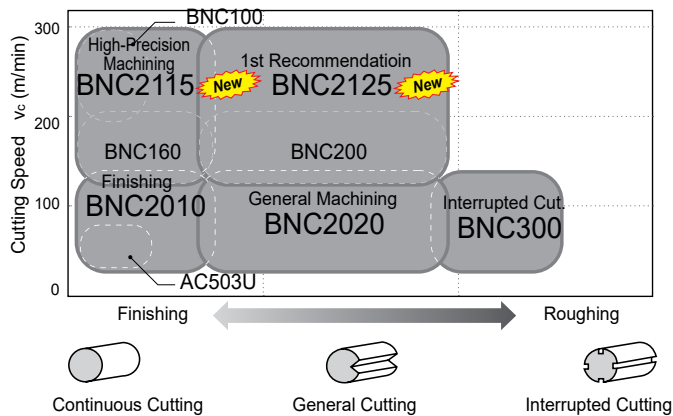

#### Uncoated SUMIBORON

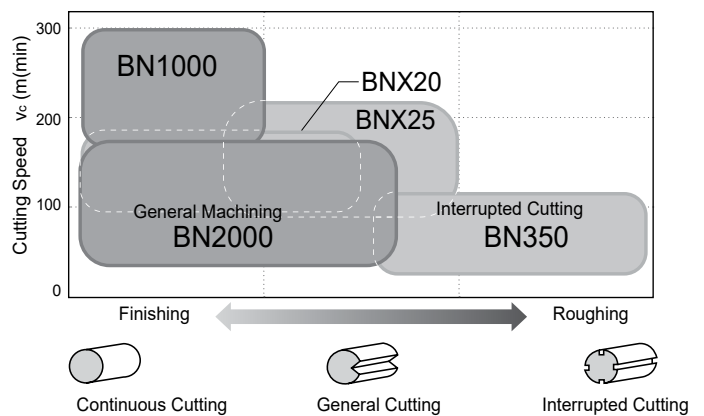

### H Recommended Cutting Conditions

(Min. - Optimum - Max.)

Cutting Process	Grade	Depth of Cut (mm)	Feed Rate (mm/rev)	Cutting Speed (m/min)
Continuous Cutting	<b>BNC2115</b>	0,03- <b>0,20</b> -0,35	0,03- <b>0,10</b> -0,20	110- <b>180</b> -300
	BNC2010	0,03- <b>0,20</b> -0,35	0,03- <b>0,10</b> -0,20	50- <b>140</b> -180
	BNC100	0,03- <b>0,15</b> -0,20	0,03- <b>0,10</b> -0,20	80- <b>200</b> -300
	BN1000	0,03- <b>0,15</b> -0,20	0,03- <b>0,10</b> -0,15	120- <b>180</b> -300
	AC503U	0,03- <b>0,50</b> -1,00	0,02- <b>0,05</b> -0,10	40- <b>70</b> -100
General Turning	<b>BNC2125</b>	0,05- <b>0,30</b> -0,50	0,05- <b>0,20</b> -0,40	110- <b>160</b> -300
	BNC2020	0,05- <b>0,30</b> -0,50	0,03- <b>0,20</b> -0,40	50- <b>120</b> -180
	BNC160	0,03- <b>0,20</b> -0,35	0,03- <b>0,10</b> -0,20	80- <b>160</b> -270
	BNC200	0,03- <b>0,30</b> -0,50	0,05- <b>0,10</b> -0,35	80- <b>140</b> -270
	BN2000	0,03- <b>0,20</b> -0,30	0,03- <b>0,10</b> -0,20	30- <b>100</b> -200
	BNX20	0,03- <b>0,30</b> -0,50	0,03- <b>0,15</b> -0,30	70- <b>130</b> -170
Interrupted Cutting	<b>BNC300</b>	0,03- <b>0,20</b> -0,30	0,03- <b>0,10</b> -0,20	50- <b>100</b> -150
	BN350	0,03- <b>0,20</b> -0,30	0,03- <b>0,10</b> -0,20	50- <b>100</b> -150
	BNX25	0,03- <b>0,20</b> -0,50	0,03- <b>0,15</b> -0,30	120- <b>160</b> -220

## Grades

### **BNC2115 / BNC2125 / BN1000 / BN2000**

- BNC2115** New  
High-precision grade realizing long tool life with excellent surface roughness and stable machining. Maintains excellent surface roughness thanks to a high notch-wear resistant coating and tough CBN substrate.
  
- BNC2125** New  
1st recommendation grade, balancing excellent wear resistance and fracture resistance in hardened steel machining. Along with a tough CBN substrate, the coating combines wear resistance and toughness to achieve long, stable tool life even in high-efficiency and interrupted machining.
  
- BN1000**  
For high speed machining. BN1000 provides the highest wear resistance of all uncoated SUMIBORON grades. Features improved fracture resistance while still placing a priority on wear resistance.
  
- BN2000**  
General purpose grade suitable for typical hardened steel machining applications. Provides a high degree of fracture and wear resistance.

## Performance

### BNC2115

Continuous Cutting of Hardened Steel

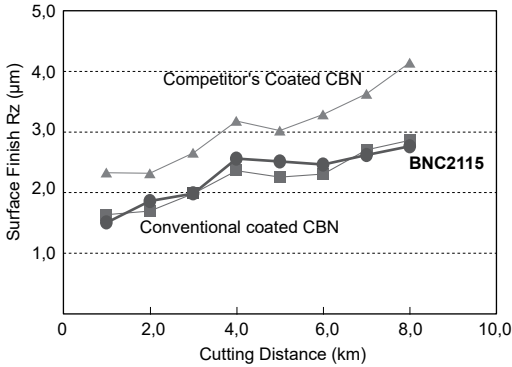

Work Material: SCM415H, 58-62HRC  
 Insert: DNGA 150408 NC4  
 Cutting Conditions:  $v_c = 200$  m/min,  $f = 0,1$  mm/rev,  $a_p = 0,15$ mm, wet

### BNC2125

Interrupted Cutting of Hardened Steel



Work Material: SUJ2, 58-62HRC  
 Insert: DNGA 150408 NC4 S01225  
 Cutting Conditions:  $v_c = 150$  m/min,  $f = 0,15$  mm/rev,  $a_p = 0,5$  mm, 63 m/times, dry

### BN1000 / BN2000

Wear Resistance (Continuous Cutting)

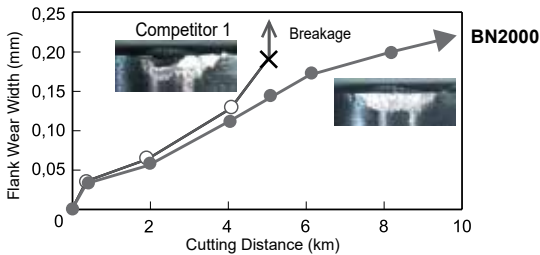

Work Material: 15CrMo5, Round Bar (58-62HRC)  
 Cutting Conditions:  $v_c = 100$  m/min,  $f = 0,1$  mm/rev,  $a_p = 0,2$  mm, dry

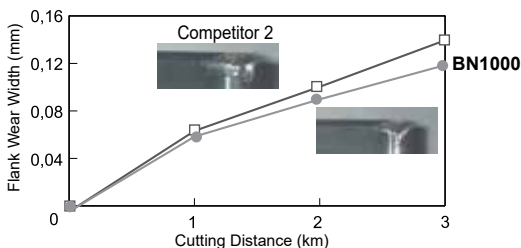

Work Material: 100Cr6, Round Bar (58-62HRC)  
 Cutting Conditions:  $v_c = 150$  m/min,  $f = 0,1$  mm/rev,  $a_p = 0,2$  mm, dry

Chipping Resistance (Interrupted Cutting)

(Comparison based on conventional BN2000 as 100%.)

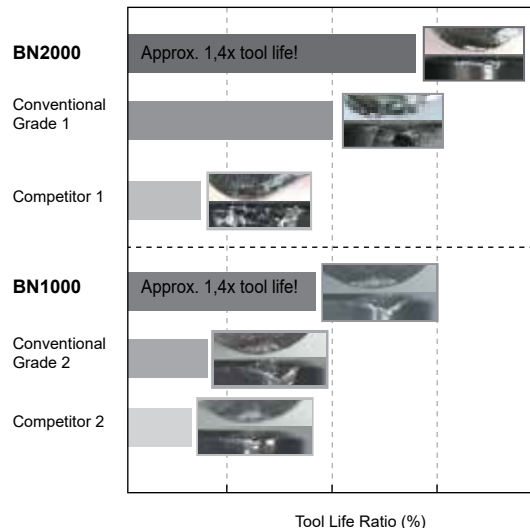

Work Material: 15CrMo5, 8V Grooved Material (58-62HRC)  
 Insert: CNGA120408 NU-2  
 Cutting Conditions:  $v_c = 150$  m/min,  $f = 0,1$  mm/rev,  $a_p = 0,2$  mm, dry

### Chipbreakers

#### Negative Type

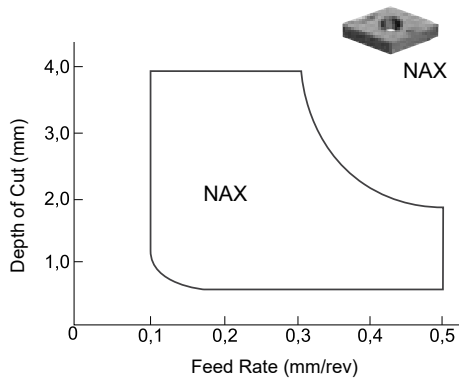

#### Positive Type

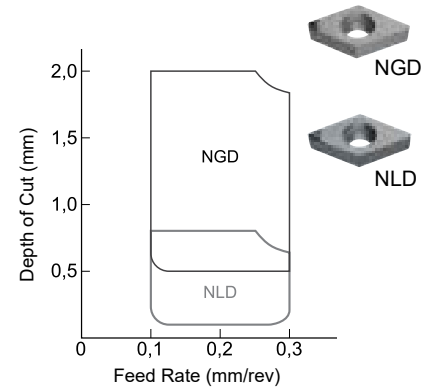
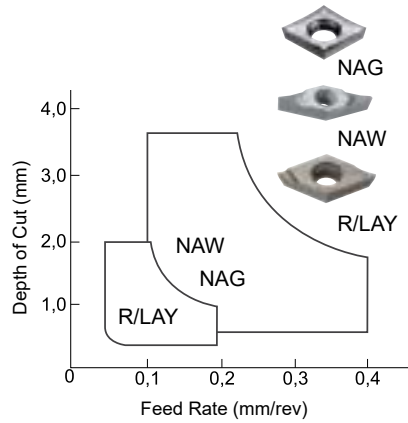

### Grades

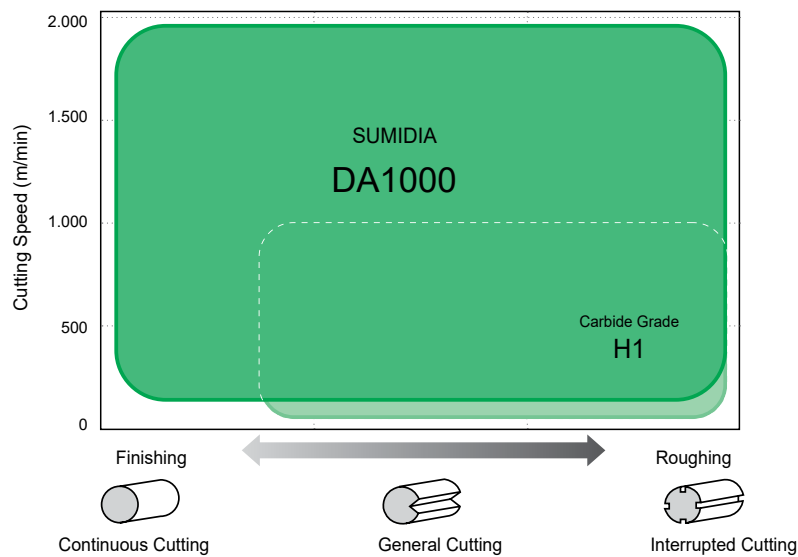

### N Recommended Cutting Conditions

(Min. - Optimum - Max.)

Cutting Process	Category	Grades	Cutting Conditions		
			Depth of Cut (mm)	Feed Rate (mm/rev)	Cutting Speed (m/min)
Continuous Cutting General Turning Interrupted Cutting	SUMIDIA	<b>DA1000</b>	0,1- <b>0,5</b> -3,0	0,05- <b>0,10</b> -0,20	-2000
	Carbide	<b>H1</b>	0,3- <b>1,0</b> -5,0	0,1- <b>0,20</b> -0,5	-1000

**Grades**

**DA1000**

- Ultra-high-density sintered, ultra-fine diamond particles
- Significantly improved surface roughness on machined surfaces
- World's best wear resistance and strength
- Suitable for use with all aluminium and non-ferrous alloys

**DA1000 Wear Resistance**

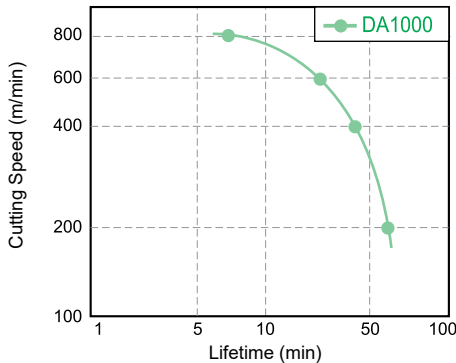

Comparison of Surface Roughness of Nose Radius Cutting Edge

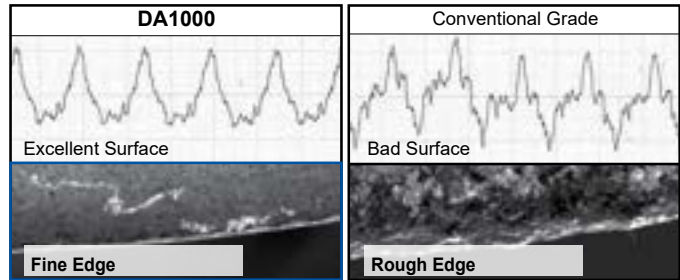

Insert: TPGW 160308  
Cutting Conditions:  $v_c = 1000$  m/min,  $f = 0,15$  mm/rev,  $a_p = 0,2$  mm, Wet

**Wear Resistance in Turning Applications**

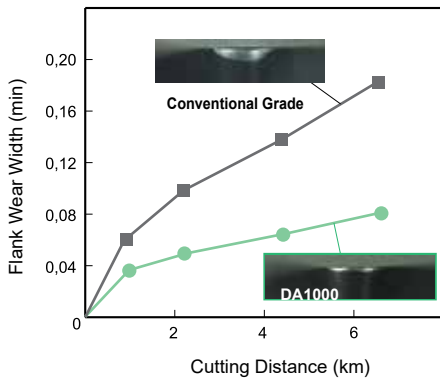

Insert: TPGN160304  
Cutting Conditions:  $v_c = 800$  m/min,  $f = 0,12$  mm/rev,  $a_p = 0,5$  mm, wet

**Wear Resistance in Milling Applications**

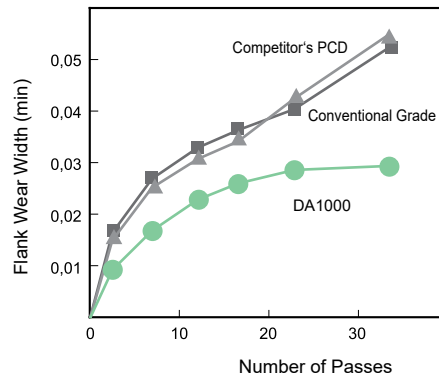

Insert: SNEW1204 ADFR-NF  
Cutting Conditions:  $v_c = 2000$  m/min,  $f = 0,15$  mm/rev,  $a_p = 3,0$  mm, wet

**Application Examples**

**H1 + NAG Type Breakers**

**ADC12 Aluminium Wheel**

Excellent adhesion resistance.  
Longer tool life.

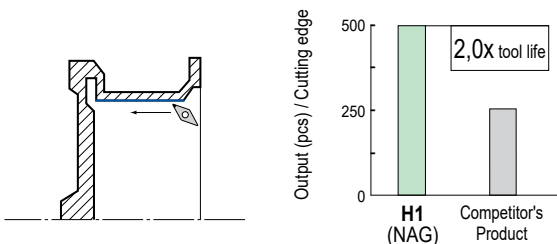

Insert: VCGT160408 NAG (H1)  
Cutting Conditions:  $v_c = 2000$  m/min,  $f = 0,25$  mm/rev,  $a_p = 2,0$  mm, wet

**DA1000**

**Copper Alloy Bush**

Stable surface roughness with no edge breakage (3,2S).  
Tool life improved to 3x that of conventional models.

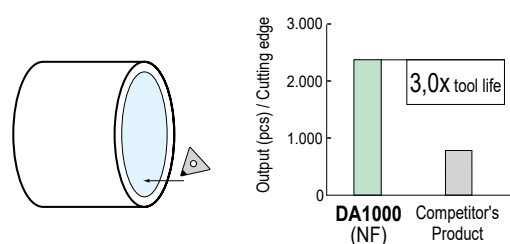

Insert: TPGN160308 NF (DA1000)  
Cutting Conditions:  $v_c = 300$  m/min,  $f = 0,07$  mm/rev,  $a_p = 0,08$  mm, wet



### Grades

Category	Application Range			Work Material					
	High Precision	Finish-Light Cut	Medium Cut	P	M	K	S	H	N
				General Steel	Stainless Steel	Cast Iron	Heat Resistant Steel	Hardened Steel	Non-Ferrous Metal
Coated Carbide (PVD)	ACZ150			◎	◎				○
	AC5015S			○	◎		◎		
	AC5025S			○	◎	○	◎		
	AC530U			○	◎	○	◎		○
	AC1030U			○	◎	○	◎		○
Cermet/Coated Cermet	T1000A			◎	○	◎			○
	T1500A/T1500Z			◎	○	○			○
Carbide	H1			○	○	○	◎		◎
	EH510			○	○	○	◎		○
CBN (SUMIBORON)	BN1000/BN2000					◎	○	◎	
	BN7000							◎	
SUMIDIA	DA1000								◎

◎ Preferred Choice      ○ Suitable

### Chipbreakers

M-Class Finishing to Light Cut

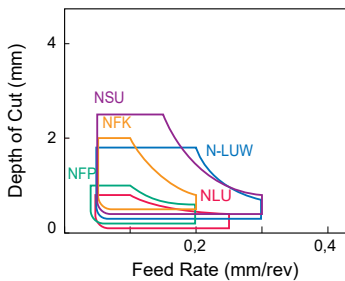

G-Class Chipbreaker (Groove Design)

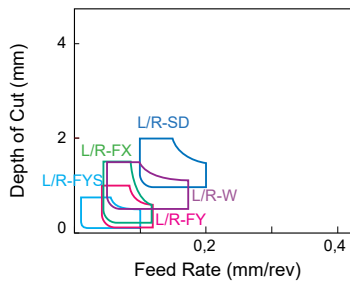

G-Class Chipbreaker (3D Design)

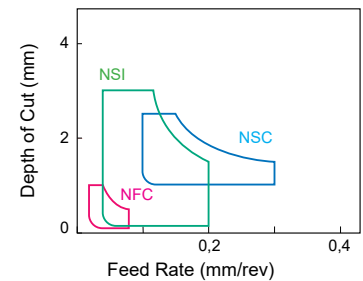

### Recommended Cutting Conditions

Grade	P Free Cutting Steel		P Carbon Steel		M Stainless Steel		S Heat Resistant Steel		H Hardened Steel		N Aluminium		N Brass	
	$v_c$ (m/min)	$f$ (mm/rev)	$v_c$ (m/min)	$f$ (mm/rev)	$v_c$ (m/min)	$f$ (mm/rev)	$v_c$ (m/min)	$f$ (mm/rev)	$v_c$ (m/min)	$f$ (mm/rev)	$v_c$ (m/min)	$f$ (mm/rev)	$v_c$ (m/min)	$f$ (mm/rev)
ACZ150	50-200	0,02-0,10	50-150	0,01-0,08	50-150	0,01-0,05					70-300	0,05-0,20	70-300	0,05-0,20
AC5015S	50-200	0,02-0,15	50-200	0,02-0,10	50-200	0,02-0,10	30-100	0,02-0,10					70-300	0,05-0,20
AC5 25S	50-200	0,02-0,15	50-200	0,02-0,10	50-200	0,02-0,10	30-100	0,02-0,10					70-300	0,05-0,20
AC530U	50-200	0,02-0,15	50-200	0,02-0,10	50-200	0,02-0,10							70-300	0,05-0,20
AC1030U	50-200	0,02-0,15	50-200	0,02-0,10	50-150	0,02-0,10							70-300	0,05-0,20
T1000A	50-200	0,02-0,15	50-200	0,02-0,10	50-150	0,02-0,10					70-300	0,05-0,20	70-300	0,05-0,20
T1500A	50-200	0,02-0,15	50-200	0,02-0,10	50-150	0,02-0,10					70-300	0,05-0,20	70-300	0,05-0,20
T1500Z	50-200	0,02-0,15	50-200	0,02-0,10	50-150	0,02-0,10					70-300	0,05-0,20	70-300	0,05-0,20
BN1000									120-300	0,03-0,15				
BN2000									50-200	0,03-0,20				
BN7000							50-200	0,05-0,20						
DA1000											70-300	0,02-0,10	70-300	0,02-0,10

### Application Range

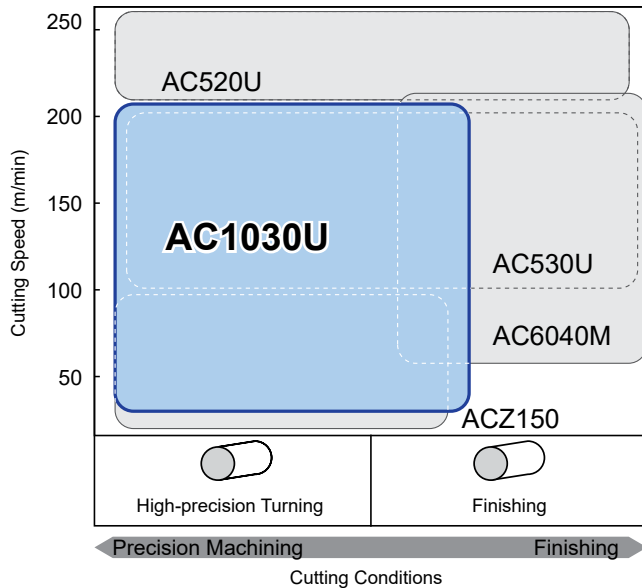

**ABSOTECH**

### AC1030U

Employs a new PVD coating, with a special tough carbide substate. Achieving excellent machined surface quality with a high-quality cutting edge that reduces adhesion and micro-chipping.

### AC1030U Performance

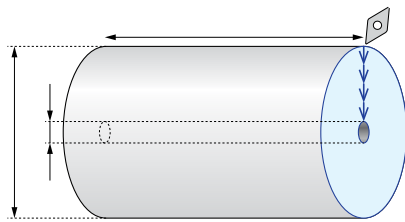

Material: X5CrNiS18-10, 1.4301  
 Insert: DCGT11T302RFY (AC1030U)  
 Cutting Data:  $v_c = 100$  m/min,  $f = 0,05$  mm/rev,  $a_p = 0,1$  mm, wet (Oil)

#### Wear Resistance

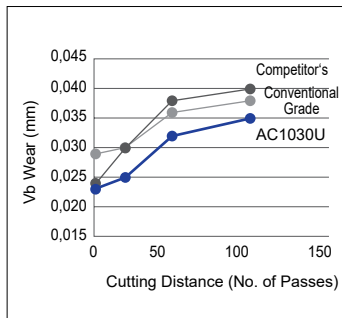

#### Roughness

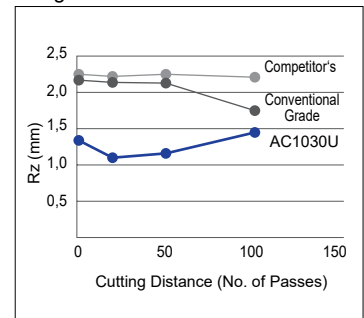

### Application Examples

#### STKM12C-EC, Pipe

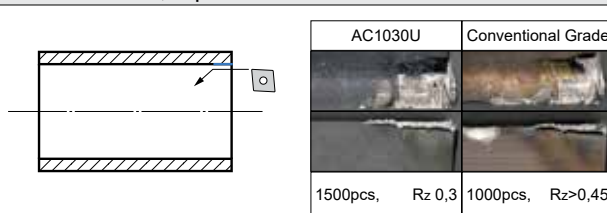

Insert: CCGT060201LFX (AC1030U)  
 Cutting Data:  $v_c = 196$  m/min,  $f = 0,04$  mm/rev,  $a_p = 0,4$  mm, wet

#### C45, Stator Shaft

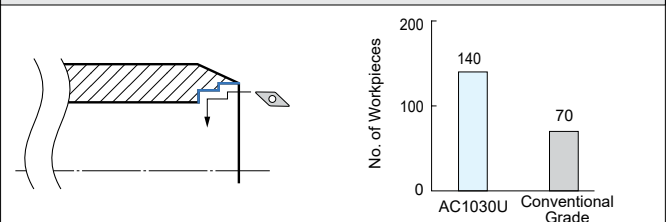

Insert: VCGT110302RFX (AC1030U)  
 Cutting Data:  $v_c = 195$  m/min,  $f = 0,12$  mm/rev,  $a_p = 0,175-0,25$  mm, wet

#### X5CrNiS18-10, 1.4301, Valve Body

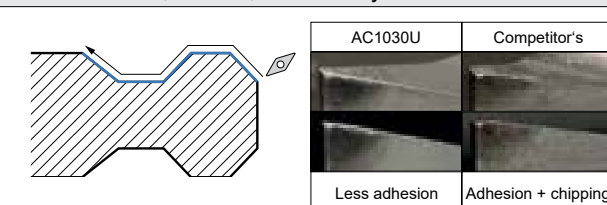

Insert: VCGT110301RFY (AC1030U)  
 Cutting Data:  $v_c = 31,5$  m/min,  $f = 0,025$  mm/rev,  $a_p = 0,2$  mm, wet

#### X6Cr17, Sensor Housing

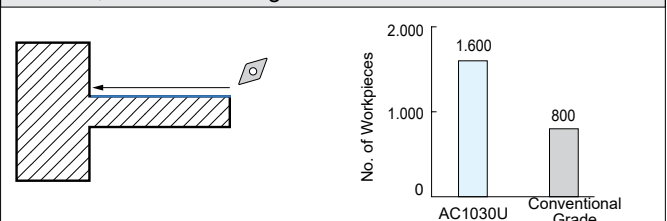

Insert: DCGT11T304M NFC (AC1030U)  
 Cutting Data:  $v_c = 50$  m/min,  $f = 0,06$  mm/rev,  $a_p = 0,2$  mm, wet

# New Grades for Milling

**ACU2500 / XCU2500 / XCK2000**

**New**

**New**

Insert Selection

## Features of ACU2500

- Utilizing ABSOTECH, a new coating with excellent wear and chipping resistance.
- Adopts a carbide substrate with excellent fracture resistance and wear resistance, realising stable long tool life with various work material grades. Our 1st recommended grade for milling.

## Features of XCU2500 / XCK2000

- Uses the revolutionary ABSOTECH X coating, combining the wear resistance of conventional CVD coatings and fracture resistance equivalent to that of PVD coatings.
- Superb long tool life in machining of steel, cast iron, and stainless steel.

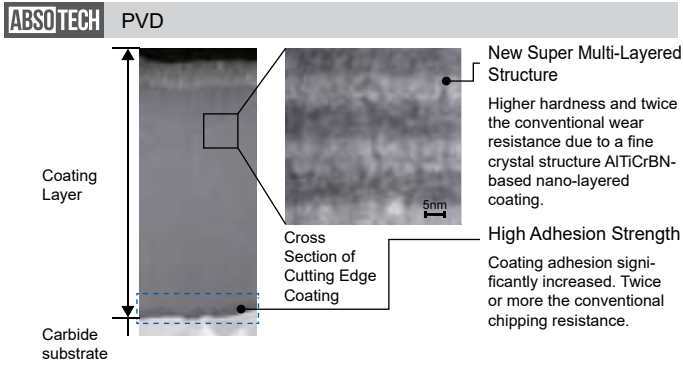

Applicable Grades: ACU2500, ACP3000, ACK3000

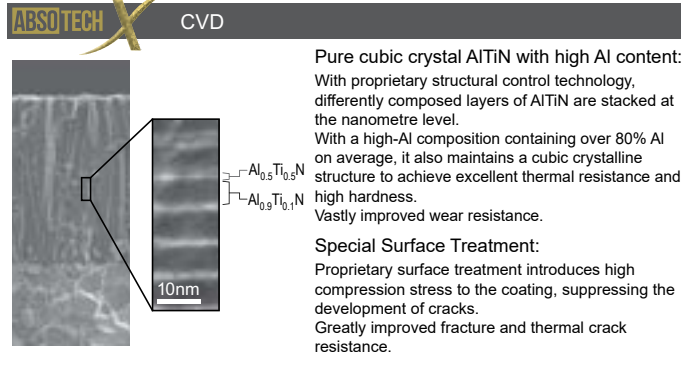

Applicable Grades: XCU2500, XCK2000

## Application Range

### P Steel

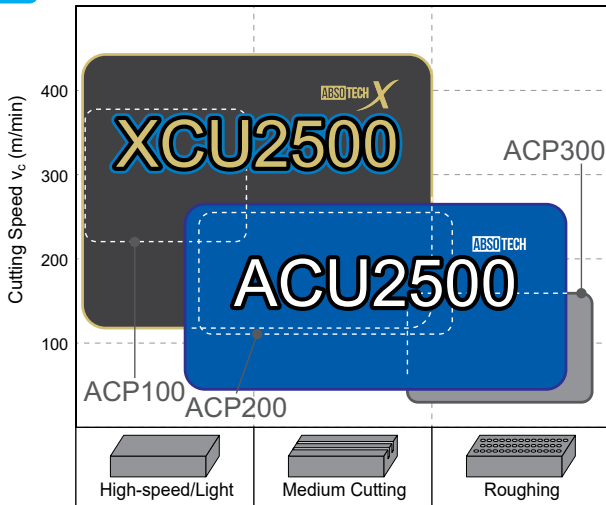

### M Stainless Steel

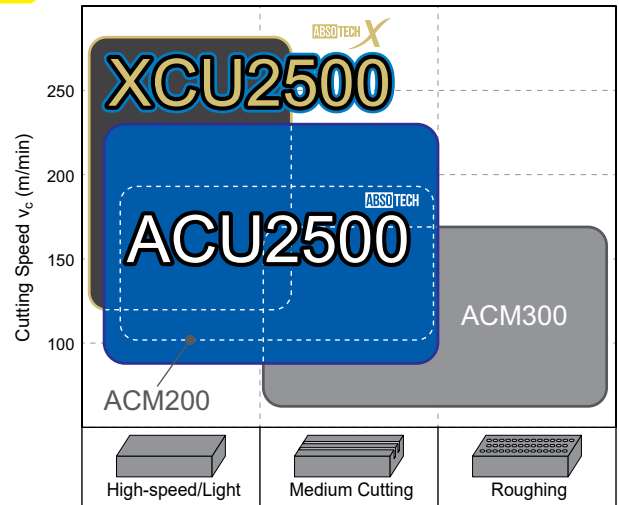

### K Cast Iron

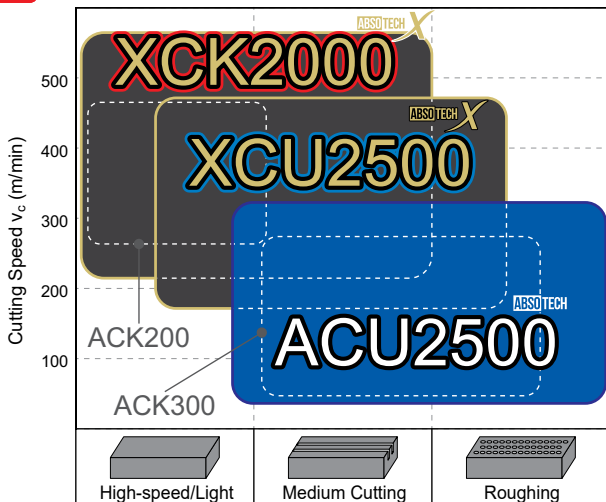

### S Exotic Alloy

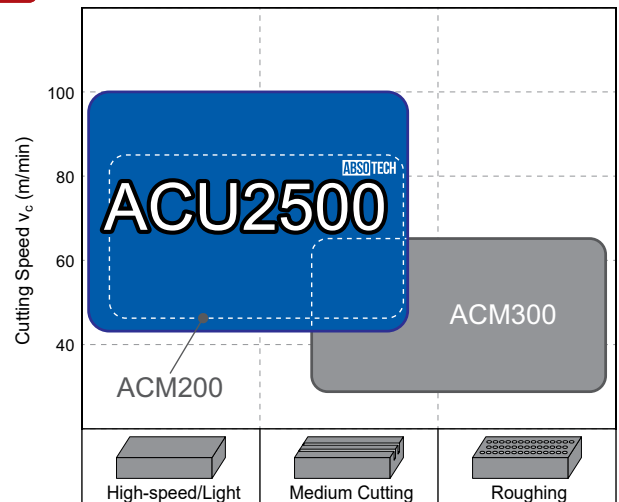

# Grades

# B



**B1–B14**



Grades

Coated Grades	<b>Coating Series</b> .....	B2
	<b>CVD / PVD Series</b> .....	B3–4
Coated and Uncoated	<b>Cermet</b> .....	B5
Uncoated Carbide	<b>“Igetalloy”</b> .....	B6
CBN Grades	<b>“SUMIBORON”</b> .....	B7–8
PCD Grades	<b>“SUMIDIA”</b> .....	B9
	<b>“SUMIDIA” Binderless</b> .....	B10
Chart	<b>Grades Comparison Chart</b> .....	B11–14

# Coated Carbide

**ABSOTECH X** : Revolutionary coating technology that realises superb tool life.

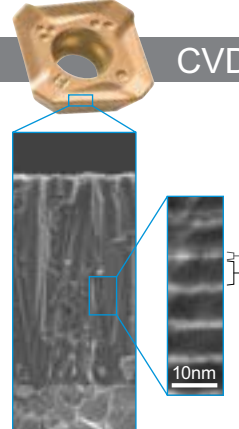

**CVD**

Pure cubic crystal AlTiN with high Al content:  
With proprietary structural control technology, differently composed layers of AlTiN are stacked at the nanometre level. With a high-Al composition containing over 80% Al on average, it also maintains a cubic crystalline structure to achieve excellent thermal resistance and high hardness. Vastly improved wear resistance.

**Special Surface Treatment:**  
Proprietary surface treatment introduces high compression stress to the coating, suppressing the development of cracks. Greatly improved fracture and thermal crack resistance.

Realises extremely long tool life for general machining through high-efficiency machining, using revolutionary technology combining wear resistance and fracture resistance.

[ABSOTECH X] For CVD Milling  
Applicable Grades  
For Milling: **XCU2500, XCK2000**

**ABSOTECH** : New coating technology that realises absolute stability.

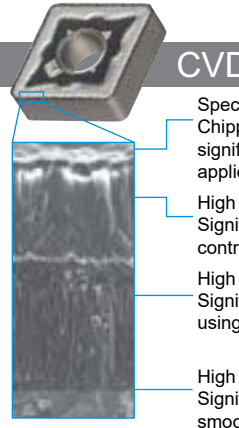

**CVD**

**Special Surface Treatment:**  
Chipping resistance and adhesion resistance are significantly improved by special surface treatment applied to suit the application.

**High Strength Alumina Layer:**  
Significantly improves the coating strength by controlling crystal growth direction.

**High Hardness Micro-Grain TiCN Layer:**  
Significantly improves the coating hardness by using a fine and uniform crystal structure.

**High Adhesion Technology:**  
Significantly improves adhesion strength through a smooth interface between the coating and carbide substrate.

- Suppresses abnormal damage such as chipping and adhesion. Stable machining is achieved in various situations.
- Next-level high strength and high hardness coating is achieved. Achieves long, stable tool life even in high-efficiency machining.

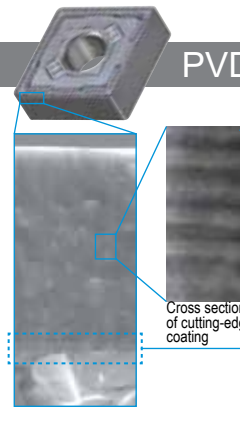

**PVD**

The Proprietary Super Multi-layered Coating Structure:  
Advanced nanotechnology enables nanometre level thickness (1 nanometre is one billionth of a meter). Hardness, thermal resistance and toughness are significantly improved by alternately layering one thousand layers of super thin films.

**High Adhesion Technology:**  
Significantly improves adhesion strength through advanced control technology at the interface of the coating and carbide substrate.

- Optimised coating composition according to application. Achieves stable machining regardless of the work material.
- Significantly improves chipping resistance by improving coating adhesion strength. Stable machining is realised even under high load conditions.

Applicable Grades

For Turning:	Steel	AC8015P, AC8020P, AC8025P, AC8035P
	Stainless Steel	AC6020M, AC6030M
	Cast Iron	AC4010K, AC4015K
For Milling:		ACP2000, ACK2000

Applicable Grades

For Turning:	Stainless Steel	AC6040M
	Exotic Alloy	AC5005S, AC5015S, AC5025S
	Small Lathes	AC1030U
For Milling:		<b>ACU2500, ACP3000, ACK3000</b>

**Brilliant Coat**

Brilliant Coat provides excellent lubricity for higher quality machining.

- PVD coating with excellent wear resistance and lubricity.
- Suppresses reactions with work material and realises beautiful machined surfaces.

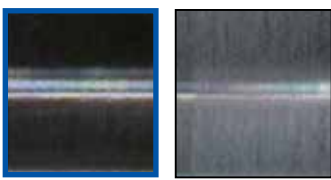

Brilliant Coat      Conventional Coating

Work Material: STKM13A  
Insert: CNMG120408NLU  
Cutting Conditions: v<sub>c</sub>: 100 m/min  
f: 0,15 mm/rev  
a<sub>p</sub>: 1,0 mm, wet

Applicable Grades  
For steel turning      T1500Z, T2500Z

**AURORA Coat** (DLC : Diamond Like Carbon)

Using our proprietary PVD process technology, we have developed a hydrogen-free DLC coating that is extremely hard and smooth.

Comparison of Cutting Edge Adhesion After Cutting ADC12

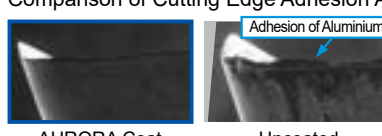

AURORA Coat      Uncoated

- Second only to diamond in terms of hardness, this smooth coating has a low coefficient of friction and provides excellent adhesion resistance to deliver better-quality machined surfaces.
- Can be used for high-speed, high-efficiency cutting of aluminium alloys, copper alloys, resins, and more.

Work Material: STKM13A  
Cutting Conditions: v<sub>c</sub>: 100 m/min  
f: 0,15 mm/rev  
a<sub>p</sub>: 1,0 mm, wet

Applicable Grades

For Milling	DL1000, DL2000
For Endmilling	DL1000, DL1200
For Drilling	DL1300, DL1500

## Characteristic Values

### For Turning (CVD)

Class	Grade	Hardness (HRA)	TRS (GPa)	Coating Type	Coating Thickness (µm)	Characteristics	Old Grades
<b>P</b>	AC8015P	91,0	2,3	Absotech	14	For high-speed and high-efficiency machining of steel. Crystal orientation control technology is used to drastically suppress the advancement of crater wear, achieving long, stable tool life during high-speed and high-feed cutting.	AC810P
	<b>New</b> AC8020P	90,5	2,2	Absotech	18	Our 1st recommended grade for mill-scale work on forged material. Alumina coating with even higher strength balances outstanding stability and wear resistance in mill-scale work.	AC820P
	AC8025P	90,1	2,3	Absotech	12	A P20 grade that drastically reduces the occurrence of abnormal damage and achieves long and stable tool life by employing a special carbide substrate and the new Absotech Platinum coating.	AC820P
	AC8035P	89,4	2,6	Absotech	9	For interrupted machining of steel. Coating layer tensile stress removal technology greatly improves fracture resistance and achieves long, stable tool life during heavy interrupted cutting.	AC830P
<b>M</b>	AC6020M	90,1	2,3	Absotech	5	An M20 grade that maintains wear resistance in stainless steel machining while drastically reducing the occurrence of abnormal damage by employing a special carbide substrate and the new Absotech Platinum coating.	AC610M
	AC6030M	89,5	2,7	Absotech	5	The first recommended grade for general machining of stainless steel that drastically reduces the occurrence of abnormal damage in stainless steel machining and achieves long and stable tool life by employing a new coating: Absotech Platinum.	AC630M
	AC630M	89,5	2,7	Super FF Coat	5	A general purpose grade featuring improved wear and fracture resistance during stainless steel cutting. Utilises a special tough carbide substrate with a thin Super FF Coat.	AC304
<b>K</b>	AC4010K	91,1	2,5	Absotech	20	1st recommended grade for turning grey cast iron. For high-speed cast iron milling. New thick coating realizes stable long tool life even with ultra-high-speed machining of grey cast iron at $v_c = 700$ m/min.	AC405K
	AC4015K	91,1	2,5	Absotech	16	1st recommended grade for turning ductile cast iron. New high-adhesion, high-strength coating realises high wear resistance and chipping resistance for stable long tool life over a wide range of cutting conditions.	AC415K
	AC420K	91,1	2,5	Super FF Coat	12	A new, extremely versatile grade that can be used for rough, interrupted cutting of ductile and grey cast iron. Employs special, ultra-hard carbide substrate and Super FF Coat to provide stability and long tool life.	AC700G

### For Milling (CVD)

Class	Grade	Hardness (HRA)	TRS (GPa)	Coating Type	Coating Thickness (µm)	Characteristics	Old Grades
<b>P</b>	ACP100	89,3	3,1	Super FF Coat	6	A grade that employs a tough carbide substrate and thin-layer Super FF Coat to provide superior thermal crack and wear resistance in high-speed milling of steel.	AC230
	ACP2000	89,5	3,2	Absotech	10	For high-speed machining of steel. Stable long tool life with high-speed machining is realized by adopting a tough carbide substrate and a new coating with excellent thermal crack resistance.	ACP100
	<b>New</b> XCU2500	89,5	3,2	AbsotechX	6	General purpose grade for a wide variety of materials such as steel, cast iron and stainless steel. New coating combining wear and fracture resistance realises long tool life in medium-speed to high-speed machining.	
<b>M</b>	ACM200	89,8	3,4	Super FF Coat	6	A grade ideal for hardened steel machining that provides excellent wear and heat resistance by employing a newly-developed ultra-hard carbide and Super FF Coat.	AC230
<b>K</b>	ACK100	92,0	2,4	Super FF Coat	6	A grade that employs a high-strength carbide substrate and Super FF Coat to provide excellent wear resistance in high-speed milling.	—
	ACK200	91,7	2,5	Super FF Coat	6	A grade that employs a tough carbide substrate and thin-layer Super FF Coat to provide superior thermal crack and wear resistance for high-speed milling.	AC211
	ACK2000	91,7	3,1	Absotech	10	For high-speed cast iron milling. Stable long tool life with high-speed machining is realized by adopting a tough carbide substrate and a new coating with excellent thermal resistance.	ACK100 ACK200
	<b>New</b> XCK2000	91,7	2,5	AbsotechX	6	For high-speed cast iron milling. Along with a high-hardness carbide substrate, the new coating combining wear and fracture resistance realises superb long tool life in medium-speed to high-speed machining.	—



## Characteristic Values

### For Turning (PVD)

Class	Grade	Hardness (HRA)	TRS (GPa)	Coating Type	Coating Thickness (µm)	Characteristics	Old Grades
<b>P</b>	<b>T1500Z</b> (Cermet)	92,0	2,2	Brilliant Coat*	3	For finishing of steel. Adopts Brilliant Coat for excellent lubricity and higher machined surface quality.	T2000Z
	<b>T2500Z</b> (Cermet)	91,8	2,4	Brilliant Coat*	3	For finishing of steel. The use of Brilliant Coat with excellent lubricity and a tough cermet substrate realises excellent machined surface quality and superb stability.	T3000Z
	<b>AC530U</b>	91,4	3,3	Super ZX Coat	3	For interrupted and general steel cutting. Utilizing the super multi-layered PVD coating of nanometre thick TiAlN and AlCrN layers, coupled with a fine-grained super tough substrate for excellent fracture resistance.	ACZ310
<b>M</b>	<b>AC6040M</b>	91,6	3,8	Absotech	3	The first recommended grade for interrupted machining of stainless steel that drastically improves the reliability in unstable machining thanks to the excellent adhesion and peel-off resistance of the new Absotech Bronze PVD coating, as well as the improved fracture resistance of the exclusive ultra-hard carbide substrate.	AC530U
	<b>AC530U</b>	91,4	3,3	Super ZX Coat	3	Heavy interrupted machining and stainless steel machining. Utilizing the super multi-layered PVD coating of nanometre thick TiAlN and AlCrN layers, coupled with a fine-grained super tough substrate for excellent fracture resistance.	ACZ310
<b>S</b>	<b>AC5005S</b>	93,1	2,8	Absotech	5	Grade for high-speed and high-efficiency machining of exotic alloys. The use of a dedicated carbide substrate with great high-temperature strength realises excellent wear resistance in high-speed, high-efficiency machining.	—
	<b>AC5015S</b>	92,7	3,2	Absotech	5	The first recommended grade for turning exotic alloy. Adopts a carbide substrate with excellent thermal resistance and a new coating with excellent wear resistance and chipping resistance, realizing stable long tool life over a wide range of cutting conditions.	AC510U
	<b>AC5025S</b>	91,8	3,6	Absotech	5	For partially interrupted to interrupted machining of exotic alloy. Adopts a carbide substrate with excellent fracture resistance and a new coating with excellent wear resistance and chipping resistance, realizing stable long tool life with unstable cutting conditions.	AC520U
<b>H</b>	<b>AC503U</b>	93,2	1,7	Super ZX Coat	3	For hardened steel. Utilizing the super multi-layered PVD coating of nanometre thick TiAlN and AlCrN layers, coupled with an ultra-hard substrate for excellent wear resistance.	—
Small Product Machining	<b>ACZ150</b>	91,4	3,3	ZX Coat	1	For small tools, and high-precision finishing to general finishing applications. TiN ultra-thin coating and fine-grained, super tough substrate combine to give good edge sharpness and superior cut finish.	—
	<b>AC1030U</b>	91,6	3,8	Absotech	2	For precision machining that supports a wide range of work materials. Employs the new "Absotech Bronze" coating with excellent adhesion and peel-off resistance to deliver excellent machined surface quality with improvements in cutting edge quality and superb stability.	—

### For Milling (PVD)

Class	Grade	Hardness (HRA)	TRS (GPa)	Main Coating Components	Coating Thickness (µm)	Characteristics	Old Grades
<b>P</b>	<b>ACU2500</b>	91,6	3,8	Absotech	3	General purpose grade supporting steel, stainless steel and cast iron machining. Adopts a carbide substrate with excellent fracture resistance and wear resistance, plus a new coating with wear and chipping resistance, realizing stable long tool life with various work material grades.	—
	<b>ACP200</b>	89,5	3,2	Super ZX Coat	3	For general machining of general and die steel. Employs PVD coating consisting of multiple nanometre-thin layers. A general grade that achieves a good balance between fracture resistance and wear resistance when combined with an exclusive tough substrate.	ACZ330
	<b>ACP300</b>	89,3	3,1	Super ZX Coat	3	For interrupted machining and stainless steel machining. Employs PVD coating consisting of multiple nanometre-thin layers. Provides excellent fracture resistance when combined with an ultra-tough substrate.	ACZ350
	<b>ACP3000</b>	89,5	3,2	Absotech	3	1st recommended grade for milling steel. Carbide substrate with excellent thermal crack resistance, plus a new coating with excellent wear and chipping resistance, realizes stable long tool life over a wide range of cutting conditions.	ACP200 ACP300
<b>M</b>	<b>ACM100</b>	91,4	3,3	Super ZX Coat	3	A grade that provides excellent wear resistance by employing an ultra-hard fine-grained carbide and New Super ZX Coating.	ACZ310
	<b>ACM300</b>	89,8	3,4	Super ZX Coat	3	The first recommended grade for stainless steel machining that achieves a good balance between wear resistance and fracture resistance by employing a newly-developed ultra-hard carbide and New Super ZX Coating.	—
<b>K</b>	<b>ACK300</b>	91,4	3,3	Super ZX Coat	3	General-purpose grade with an excellent balance of wear and fracture resistance.	ACZ310
	<b>ACK3000</b>	91,7	3,1	Absotech	3	1st recommended grade for milling cast iron. Adopts a high thermal conductivity carbide substrate and a new coating with excellent wear and chipping resistance, realizing stable long tool life over a wide range of cast iron machining operations.	ACK300
<b>N</b>	<b>DL1000</b>	92,9	2,1	AURORA Coat (DLC Coat)	0,5	For milling non-ferrous metal, utilizing DLC coat with a low coefficient of friction and excellent adhesion resistance.	—
	<b>DL2000</b>	91,6	3,8	AURORA Coat (DLC Coat)	0,5	For milling non-ferrous metal, utilizing DLC coat with a low coefficient of friction and excellent adhesion resistance.	—

\*There may be minor differences in the colour tone/lustre of Brilliant Coat grades due to the interference of light. Such differences have no effect on performance.

# TiC / TaC (Titanium Carbide) Cermet



Various grades and expanded lineup of catalogue items meet a wide range of finishing needs.

Lineup includes wear-resistant T1000A, general purpose T1500A, general purpose coated cermet T1500Z and tough T2500A. Significantly expanded lineup of catalogue items for a wide variety of finishing applications.

## Characteristics

### Uncoated Cermet

**T1000A** High Speed Finishing Grade  
High speed finishing grade with excellent wear resistance. Improved wear and fracture resistance. Solid solution hard phase reduces reaction with steel. Perfect for high-speed continuous finishing of steel, cast iron and powdered metal.

### Coated Cermet

**T1500Z** New General Purpose Grade  
General purpose coated cermet grade that employs new Brilliant Coat\* PVD coating with excellent lubricity. Excellent wear resistance provides long tool life. Reduces adhesion of work material for beautiful finished surfaces.

### Uncoated Cermet

**T1500A**  
A general purpose grade that provides both wear and fracture resistance with higher-quality surface finish. Mixing hard phases of different functionality, grain size and composition improves balance of wear and fracture resistance. Improved cutting edge treatment technology provides beautiful finished machined surfaces.

### Coated Cermet

**T2500Z**  
Tough grade with excellent fracture resistance and thermal crack resistance. Fine, uniform grain structure greatly improves toughness. Improves thermal crack resistance due to the high thermal conductivity and realises long stable tool life. Uses Brilliant Coat, with excellent lubricity to realise excellent machined surface quality.

## Characteristic Values

### For Turning

Class	Grade	Hardness (HRA)	TRS (GPa)	Coating Type	Coating Thickness (µm)	Characteristics	Old Grades
<b>P</b>	T1000A	93,3	1,8	—	—	Uncoated cermet grade with excellent wear resistance that provides good cost efficiency. Demonstrates excellent wear resistance in continuous finishing applications, and stable finishing of cast iron and sintered alloy as well as steel.	T110A
	T1500A	92,0	2,2	—	—	A general purpose grade that employs a substrate with improved balance of fracture and wear resistance to deliver superior finished surfaces in a wide variety of cutting conditions.	T1200A
	T2500A	91,8	2,4	—	—	For interrupted machining of steel. Fine, uniform grain structure greatly improves toughness, realizing long tool life and excellent surface finish even with interrupted cutting.	—
	T1500Z	92,0	2,2	PVD Brilliant Coat*	3	Brilliant Coat's* new PVD coating gives excellent lubricity for higher quality machining. General-purpose coated cermet grade that can maintain high-quality machined surfaces and also gives excellent wear resistance.	T2000Z
	T2500Z	91,8	2,4	PVD Brilliant Coat*	3	For finishing of steel. The use of Brilliant Coat with excellent lubricity and a tough cermet substrate realises excellent machined surface quality and superb stability.	T3000Z
<b>K</b>	T1000A	93,3	1,8	—	—	Exclusive uncoated cermet grade with excellent cost efficiency suitable for cast iron finishing, which requires high hardness.	T110A

### For Milling

Class	Grade	Hardness (HRA)	TRS (GPa)	Coating Type	Coating Thickness (µm)	Characteristics	Old Grades
<b>P</b>	T1500A	92,0	2,2	—	—	A general-purpose grade that employs a substrate with an improved balance between fracture and wear resistance to deliver superior finished surfaces in a wide variety of cutting conditions.	T1200A
	T250A	91,4	2,1	—	—	Tough cermet grade with enhanced crack advancement resistance.	—
<b>M</b>	T2500A	91,8	2,2	—	—	For finishing of steel and stainless steel. Fine, uniform grain structure greatly improves toughness, realizing long tool life and excellent surface finishing.	T250A
	T4500A	91,0	2,3	—	—	For finishing of steel and stainless steel. Tough grade with excellent fracture resistance and reduced thermal cracking.	—

\*There may be minor differences in the colour tone/lustre of Brilliant Coat grades due to the interference of light. Such differences have no effect on performance.

# WC (Tungsten Carbide) „Igetalloy“

Igetalloy carbides have a solid history and a big variety of grades to suit many different applications. They are widely used and appreciated for their superior performance.

The Igetalloy line-up consists of carbide cutting tools that are available in a variety of different structures and compositions, each differing in terms of WC grain size and containing varying amounts of CO binder and TiC, TaC, and other double carbide components. The wide selection enables excellent wear resistance and toughness with a variety of work materials and cutting conditions.

● For Steel

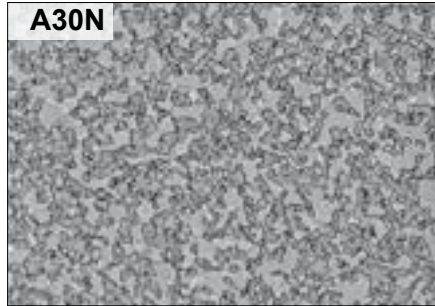

● For Stainless Steel

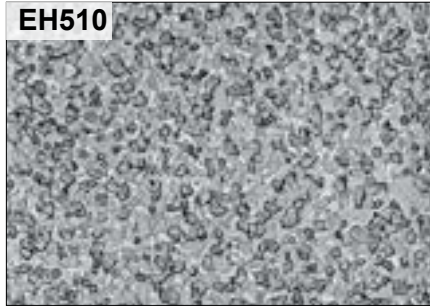

● For Cast Iron

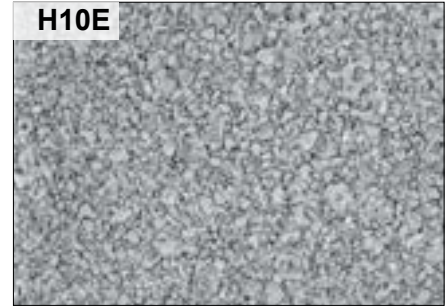

## Characteristic Values

Application	Grade	Hardness (HRA)	TRS (GPa)	Young's Modulus (GPa)	Thermal Conductivity (W/m·°C)	Compressive Strength (GPa)	Linear-Thermal Expansion Coefficient (X 10 <sup>-6</sup> /°C)
<b>P</b>	ST10P	92,1	1,9	470	25	4,9	6,2
	ST20E	91,8	1,9	550	42	4,8	5,2
	A30	91,3	2,1	520	—	—	5,2
	A30N	91,2	2,2	520	—	—	—
	ST40E	90,4	2,6	—	75	—	—
<b>M</b>	EH510	92,6	2,6	—	—	—	—
	EH520	91,7	3,0	—	—	—	—
	A30	91,3	2,1	520	—	—	5,2
	A30N	91,0	2,4	—	—	—	—
<b>K</b>	BL130	94,3	2,9	—	—	—	—
	H2	93,2	1,8	600	105	6,1	4,4
	H1	92,9	2,1	650	109	6,1	4,7
	EH510	92,6	2,6	—	—	—	—
	H10E	92,3	2,0	—	67	—	—
	EH520	91,7	3,0	—	—	—	—
	G10E	91,1	2,2	620	105	5,7	—
<b>N</b>	H1	92,9	2,1	650	109	6,1	4,7
	H20	91,6	3,8	—	—	—	—
<b>S</b>	EH510	92,6	2,6	—	—	—	—
	EH520	91,7	3,0	—	—	—	—

# CBN (Cubic Boron Nitride) SUMIBORON



**High hardness and heat resistance for cutting high hardness steel and hard cast iron. Long tool life with high-speed finishing of grey cast iron.**

In 1977, Sumitomo Electric Hardmetal successfully developed a revolutionary CBN sintered tool - SUMIBORON. The main component in SUMIBORON is Cubic Boron Nitride with a special ceramic binder sintered under super high pressure and temperature. As compared to other conventional tool materials, CBN has higher hardness and excellent heat resistance.

With these distinct characteristics, SUMIBORON can perform machining of hardened steel, high hardness cast iron and exotic metals where previously only grinding was done. Furthermore, excellent efficiency and longer tool life can also be achieved from high speed machining of cast irons.

Grades

## Characteristics

Classifications	Structure	CBN Content	Hardness (GPa)	Grades	Application	Characteristics
Purely CBN particles, firmly bonded		High	54	NCB100	Cast Iron, Titanium Alloy, Pure Titanium, Co-Cr-Alloy, Cemented Carbide, Cermet	Containing no binder, the nano-to sub-micron CBN particles have a directly bonded structure. The high hardness and thermal conductivity make it highly efficient with a long tool life when machining exotic alloys such as titanium alloys and Co-Cr alloys.
Mainly CBN grains fused together		↓ Low	↓ 27	BN7000 BN7500 BN7115 BNC8125 BNS8125 BNS800	Carbide, Chilled cast iron, Ni-Hard cast iron, Heat-resistant alloy, Cast iron Sintered ferrous alloy	High carbon content. Structure consists of strongly fused CBN grains. Suited to cutting cast iron, heat-resistant alloy, ultra-hard alloy, and other hard materials.
Mainly CBN grains held together with a binder				BN1000, BN2000, BN350 BNX10, BNX20, BNX25 BN500, <b>New</b> BNC2115, <b>New</b> BN2010, BN2020 BNC300, BNC100, BNC160 BNC200, BNC500	Alloy steel, Case hardened steel, Carbon tool steels, Bearing steel, Die steel, Ductile cast iron	CBN grains are fused together strongly with a special ceramic binder. Strong CBN binding force gives superior wear resistance and toughness when cutting hardened steel and cast iron.

## Grade Range Map

Class	Application	High-speed Cutting	Finishing – Light Cutting	Medium Cutting	Rough – Heavy Cutting	
<b>H</b>	Classification	–	H01	H10	H20	H30
	Coated SUMIBORON			BNC2115 <b>New</b>	BNC2125 <b>New</b>	
			BNC2010		BNC2020	BNC300
			BNC100		BNC160	
					BNC200	
			BN1000			
	Uncoated SUMIBORON		BNX10	BN2000	BNX20	BN350
		Classification	–	01	10	20
	Sintered Components	Uncoated SUMIBORON		BN7115 <b>New</b>	BN7000	
		Classification	–	K01	K10	K20
Coated SUMIBORON				BNC500*		BNC8115 <b>New</b>
Uncoated SUMIBORON				NCB100	BN500	
					BN7000	
				BNS8125 <b>New</b>	BNS800	
<b>S</b>	Classification	–	S01	S10	S20	S30
	Uncoated SUMIBORON		NCB100	BN7000		
					BNS8125 <b>New</b>	

\* Dedicated for Ductile Cast Iron.

# CBN (Cubic Boron Nitride)

## SUMIBORON

### Characteristic Values

Class	Grade	Binder	Carbon Content (%)	Grain Size (μm)	Hardness HV (GPa)	TRS (GPa)	Main Coating Components	Coating Thickness (μm)	Characteristics
	<b>New</b> BNC2115	TiN	60–65	3	31–33	1,3–1,4	TiAlSiN super multilayered coating	3	Maintains excellent surface roughness thanks to coating with high notch wear resistance and tough CBN substrate
	<b>New</b> BNC2125	TiN	65–70	4	33–35	1,5–1,6	TiAlSiN super multilayered coating	3	Along with a tough CBN substrate, the coating combines wear resistance and toughness to achieve even more stable machining.
<b>H</b>	BNC2010	TiCN	50–55	2	30–32	1,1–1,2	TiCN multi-layered	2	Improves the wear resistance of coating and substrate and stably achieves excellent surface roughness.
	BNC2020	TiN	70–75	5	34–36	1,4–1,5	TiAlN multi-layered	2	Provides long tool life in general and high-efficiency cutting thanks to tough substrate coated with a highly wear-resistant and highly adhesive layer.
	BNC100	TiN	40–45	1	29–32	1,0–1,1	TiAlN	3	Highly wear resistant coating makes this grade suited for high speed finishing.
	BNC160	TiN	60–65	3	31–33	1,2–1,3	TiAlN/TiCN	3	Stable, high precision finishing of hardened steel.
	BNC200	TiN	65–70	4	33–35	1,4–1,5	TiAlN/TiCN	3	Tough substrate with high wear resistant coating provide longer tool life.
	BNC300	TiN	60–65	1	33–35	1,5–1,6	TiAlN	1	Suited for finishing when there is a combination of continuous and interrupted cutting.
	BNX10	TiCN	40–45	3	27–31	0,9–1,0	–	–	Optimum wear resistance. Suited to continuous, high-speed cutting.
	BN1000	TiCN	40–45	1	27–31	0,9–1,0	–	–	Ultimate wear and fracture resistance. Suited to high-speed cutting.
	BNX20	TiN	55–60	3	31–33	1,0–1,1	–	–	Crater resistant grade, suitable for high efficiency cutting under high temperature conditions.
	BNX25	TiN	65–70	4	29–31	1,0–1,1	–	–	Excellent fracture resistance during high speed cutting. Suited to high speed interrupted cutting of hardened steel.
	BN2000	TiN	50–55	2	31–34	1,1–1,2	–	–	A general purpose grade for hardened steel that provides a high degree of fracture and wear resistance.
	BN350	TiN	60–65	1	33–35	1,5–1,6	–	–	High cutting edge strength. suited to heavy interrupted cutting.
Sintered Components	<b>New</b> BN7115	Co Compound	90–95	1	41–44	2,2–2,3	–	–	Grade balancing ultimate cutting edge sharpness with fracture resistance, suitable for finishing of sintered alloy.
	BN7500	Co Compound	90–95	1	41–44	2,0–2,1	–	–	Maintains optimum cutting edge sharpness. Suited for finishing of sintered alloy.
	BN7000	Co Compound	90–95	2	41–44	1,8–1,9	–	–	Improved wear and fracture resistance in rough cutting of sintered components.
<b>K</b>	<b>New</b> BNC8115	Al Alloy	85–90	8	39–42	0,95–1,15	TiAlN	2	Grade with 100% solid CBN structure, using PVD coating with excellent wear resistance to enable roughing operations.
	<b>New</b> BNS8125	Al Alloy	85–90	8	39–42	0,95–1,15	–	–	Grade with 100% solid CBN structure that exhibits excellent wear and fracture resistance.
	BN7000	Co Compound	90–95	2	41–44	1,8–1,9	–	–	Improved wear and fracture resistance in rough cutting of cast iron and exotic alloy.
	BNS800	Al Alloy	85–90	8	39–42	0,9–1,1	–	–	100% solid CBN structure with good thermal impact resistance.
	BNC500	TiC	60–65	4	32–34	1,1–1,2	TiAlN	3	Substrate with excellent wear resistance and coating makes this grade suited for hard-to-cut cast iron.
<b>S</b>	NCB100	–	100	–0,5	51–54	1,8–1,9	–	–	Achieves high-efficiency, improved machining accuracy and long tool life in machining of exotic alloys such as titanium alloy and Co-Cr alloys.



# PCD (Polycrystalline Diamond) SUMIDIA

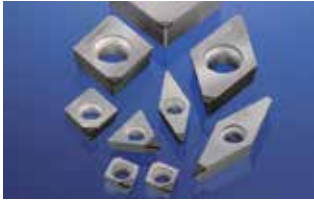
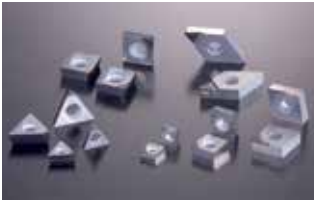

**Excellent wear resistance, longer tool life, and high-speed, high-efficiency, high-precision cutting of non-ferrous metals and non-metals.**

SUMIDIA is a polycrystalline diamond material made from sintered diamond powder that was first created using our proprietary technology in 1978.

SUMIDIA's superior wear resistance achieves longer tool life, high speed, high efficiency and high precision in non-metal cutting and non-ferrous metal applications including aluminium, copper, magnesium and zinc alloys.



SUMIDIA Binderless uses nano-polycrystalline diamond for the cutting edge, demonstrating excellent wear resistance and fracture resistance.

In particular, it achieves extended tool life and machining accuracy superior to conventional polycrystalline diamond when machining hard brittle materials such as cemented carbides.

## Features

Diamond particles on the order of sub-microns to several dozen microns, sintered at high density.

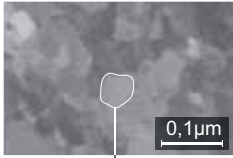
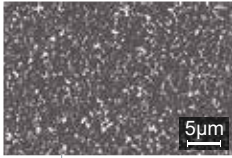
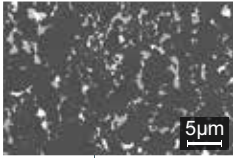
## Structure

SUMIDIA Binderless	SUMIDIA		
NPD10	DA1000	DA150	DA90
			
Diamond particles	Black areas in image are diamond particles.		

## Grade Range Map

Class	Series	Finishing – Light Cutting		Medium Cutting	Rough – Heavy Cutting
<b>Brittle Materials</b>	Classification	01	10	20	30
	SUMIDIA Binderless	NPD10			
	SUMIDIA		DA90		
<b>N</b>	Classification	N01	N02	N20	N30
	SUMIDIA	DA1000			
		DA150			
		DA90			

## Characteristic Values

Class	Grade	Binder	Carbon Content (%)	Grain Size (µm)	Hardness HV (GPa)	TRS (GPa)	Characteristics
<b>Brittle Materials</b>	NPD10	Co	100	<=0,05	120–130	≈ 3,15	100% diamond that directly binds nano-order diamond particles with high strength. Demonstrates optimum wear and fracture resistance as well as the best edge sharpness.
<b>N</b>	DA1000	Co	90–95	–0,5	110–120	≈ 2,60	High density sintered material made of ultra-fine diamond particles that demonstrates optimum wear and fracture resistance, and edge sharpness.
	DA150	Co	85–90	5	100–120	≈ 1,95	Sintered material made of fine diamond particles that provides a good balance of workability and wear resistance.
	DA90	Co	90–95	50	50–65	≈ 1,10	Coarse sintered diamond particles, with high diamond content for excellent wear resistance.



# PCD (Polycrystalline Diamond) SUMIDIA Binderless

Grades



SUMIDIA Binderless Series uses nano-polycrystalline diamond for the cutting edge and demonstrates excellent wear and fracture resistance compared to conventional sintered diamond tools.

In particular, SUMIDIA Binderless Series allows for improvements in tool life and machining precision that go far beyond conventional diamond tools in the machining of hard brittle materials, such as carbide.

### Excellent for High Precision Machining of Carbide

Nano-polycrystalline diamond with excellent wear resistance achieves high precision machining of carbide.

### Maintains Superior Dimensional Tolerances Over Many Hours

Greatly reduces the number of tool replacements compared to conventional diamond tools and increases work efficiency while reducing total costs.

### Suitable for Hard Brittle Material Machining

Hard brittle materials (such as ceramics) that could only be ground before can now be cut.

## Characteristics

### Comparison of Structure

Nano-Polycrystalline Diamond  
SEM Structure

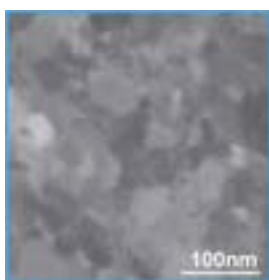

Diamond Particles  
(30–50 nm)

Conventional PCD  
SEM Structure



Diamond Particles  
(1–10 µm)

### Hardness

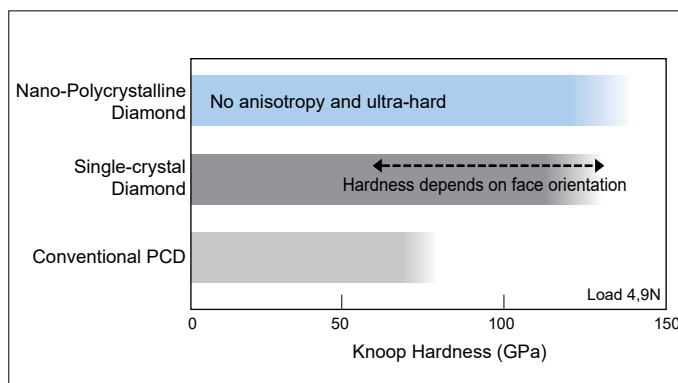

### Application (Carbide Machining)

Hardness < 88HRA

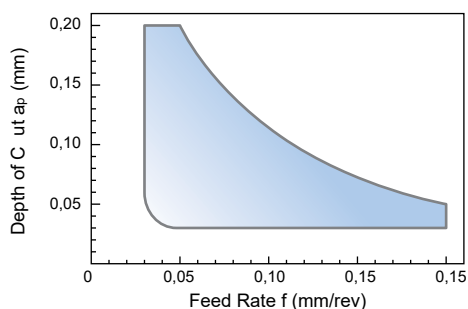

Hardness ≥ 88HRA

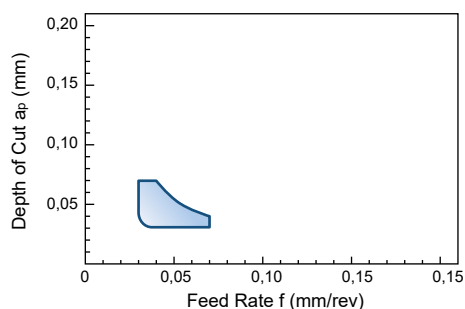

### Recommended Cutting Conditions (Carbide Machining)

Coolant: Dry

Min. - Optimum - Max.

Work Material			Cutting Conditions		
Classification	Hardness (HRA)	SEH Grade	Cutting Speed $v_c$ (m/min)	Feed Rate $f$ (mm/rev)	Depth of Cut $a_p$ (mm/rev)
VM VC	70 60 50	G7 G6	5–20–30	0,03– <b>0,10</b> –0,20	0,03– <b>0,10</b> –0,20
VM VC	40	G5 G2	5–15–30	0,03– <b>0,05</b> –0,07	0,03– <b>0,10</b> –0,20

# Grade Comparison Chart

## Coated Carbide (CVD)

Application	Class	Grade	Sumitomo Electric	Mitsubishi	Tungaloy	Kyocera	MOLDINO	Sandvik	Kennametal	SECO Tools	WALTER	ISCAR	Taegu Tec	NTK	
Turning	P	P05	<b>AC8015P</b>	UE6105 MC6115	T9105 T9205	CA510 CA5505	HG8010	GC4305 GC4205	KCP05 KCP05B	TP0501 TP0500	WPP05S WPP05 WPP01	IC8005 IC8150 IC9015	TT8105		
		P10	<b>AC8020P</b> <b>AC8015P</b> <small>New</small>	MC6115 MC6015 UE6110	T9105 T9115 T9205 T9215	CA510 CA515 CA5515	HG8010	GC4415 GC4305 GC4215 GC4315	KCP10 KCP10B	TP1501 TP1500	WPP10S WPP10	IC8150 IC8080 IC9015 IC9150	TT8115	CP7	
		P20	<b>AC8020P</b> <b>AC8025P</b> <small>New</small>	MC6025 UE6020	T9115 T9125 T9215 T9225	CA025P CA525	GM25 HG8025 GM8020	GC4425 GC4325 GC4225	KCP25 KCP25B	TP2501 TP2500	WPP20S WPP20	IC8150 IC8250 IC9015 IC9150	TT5100 TT8125	CP7	
		P30	<b>AC8035P</b> <b>AC6030M</b> <b>AC630M</b>	MC6035 UE6035	T9125 T9135 T6130	CA025P CA525 CA530	GM25	GC4325 GC4335 GC4235	KCP30 KCP30B	TP3500	WPP30S WPP30	IC8080 IC9350	TT7100 TT8135		
		P40	<b>AC8035P</b> <b>AC6030M</b> <b>AC630M</b>	MC6035	T9135 T9235 T6130	CA530 CA5535	GX30 GM8035	GC4335 GC4235 GC30	KCP40 KCP40B	TP3501 TP3500		IC9350	TT7100		
	M	S	M10 S10	<b>AC6020M</b>	MC7015 US905 US7020	T9115 T9215	CA6515	HS9105	GC2015 GC1515 S05F	KCM15	TM1501		IC9250 IC520M	TT9215 TT3005	
			M20 S20	<b>AC6020M</b> <b>AC6030M</b> <b>AC630M</b>	MC7025 US7020	T6120 T9125 T9215	CA6525	HG8025	GC2025 GC1515	KCM25	TP2501 TM2000 TM2501		IC9025 IC9325 IC4050	TT5100 TT9225	
			M30	<b>AC6030M</b> <b>AC630M</b> <b>AC8035P</b>	MC7025 US735	T6130	CA6535	GM8035 GX30 GM25	GC2035 GC235	KCM35	TP3500 TM3501 TM4000		IC9350 IC4050 IC635	TT9235	
			M40	<b>AC6040M</b> <b>AC630M</b>	US735				GC235 GC2035		TM4000			TT7800	
	K	K05	<b>AC4010K</b>	MC5005 UC5105 UC5115	T5105	CA310 CA4505 CA4010	HX3505	GC3205 GC3210	KCK05	TK0501 TK1001	WAK10 WKK10S	IC5005	TT7005 TT7505	CP1	
		K10	<b>AC4010K</b> <b>AC4015K</b>	MC5005 MC5015 MC5020 UC5105 UC5115	T515 T5105 T5115	CA315 CA4505 CA4515 CA4115	HX3305 HX3515 HG8010	GC3210	KCK15	TK1000 TK1001	WAK10 WAK20 WKK10S WKK20S	IC5100 IC9150 IC4100	TT7015	CP1	
		K20	<b>AC4015K</b> <b>AC420K</b> <b>AC425K</b> <b>AC8025P</b>	MC5015 UC5115 UE6110	T515 T5125 T9125	CA320 CA4515 CA4120 CA4115	HX3315 GM8020	GC3225	KCK15 KCK20	K2001	WAK20 WAK30 WKK20S	IC9150 IC5100 IC4100	TT7015		
	Milling	P	P10	<b>XCU2500</b> <b>ACP2000</b> <b>ACP100</b> <small>New</small>	FH7020 F7030 MV1020	T3130 T3030			GC4220 GC4330	KCPM20	MP1501 MP1500 MP2501 MP2500	WKP25 WKP25S WPP35G WKP35S	IC4100 IC5400 IC9015 IC8080 IC9080	TT7080 TT7515 TT9300	
			P20	<b>XCU2500</b> <b>ACP2000, ACP100</b> <small>New</small>	F7030			GC4330 GC4340	KCPM20 KCPK30	MP2501 MP2500	WKP25 WKP25S	IC8080 IC9080	TT7400		
			P30	<b>XCU2500</b> <b>ACP2000, ACP100</b> <small>New</small>	F7030			GC4340	KCPK30 KCMP30			IC9250 IC4050	TT7800 TT8525		
		M	S	M10	<b>XCU2500</b> <b>ACM100</b> <small>New</small>										
M20				<b>XCU2500</b> <b>ACM200</b>	F7030	T3130	CA6535	GX2160 AX2040	GC2040		MS2500	WKP35S		TT7800	
M30				<b>XCU2500</b> <b>ACM200</b>	F7030					KC994M			IC5820	TT7800	
K		K10	<b>XCK2000</b> <b>ACK2000</b> <b>ACK200</b> <small>New</small>							KCK15			IC5100	TT7515	
		K20	<b>XCK2000</b> <b>XCU2500</b> <b>ACK2000</b> <b>ACK200</b> <small>New</small>	MV1020 MC5020 F5010 F5020	T1115	CA420M	GX2120	GC3330 GC3220 GC3225 GC3020 GC3040	KC915M KC930M KC935M	MK1500	WAK15 WKP25S	IC5100 DT7150 IC4010 IC4050 IC4100	TT6800 TT7080		

## Coated Carbide (PVD)

Application	Class	Grade	Sumitomo Electric	Mitsubishi	Tungaloy	Kyocera	MOLDINO	Sandvik	Kennametal	SECO Tools	WALTER	ISCAR	Taegu Tec	NTK	
Turning	P	P10	<b>ACZ150</b> <b>AC1030U</b> <b>AC5005S</b> <b>AC5015S</b> <b>AC5025S</b> <small>New</small>	VP15TF MS6015	AH710 AH110 AH120 AH725	PR915 PR1005 PR930 PR1215 PR1225 PR1705		GC1525	KCU10 KC5510	TS2000	WSM10	IC507 IC807 IC907		TM1 VM1 DT4 DM4	
		P20	<b>AC1030U</b> <b>AC5025S</b> <b>AC530U</b>	VP15TF VP20RT	AH120 AH725 AH3135	PR1225 PR1425	IP2000	GC15 GC1125	KCU25				IC807 IC808 IC810	TT9080	TM1 TM4 VM1 QM3 DM4
		P30	<b>AC1030U</b> <b>AC530U</b>	VP15TF VP20RT	AH120 AH725 SH730 AH730	PR1425 PR1525 PR1535	IP3000 CY250	GC1125					IC328 IC928	TT8020 TT9030	QM3
		P40	<b>AC1030U</b>				PR660	IP3000	GC4335 GC4235				IC830	TT8020	

# Grade Comparison Chart

## Coated Carbide (PVD)

Application	Class	Grade	Sumitomo Electric	Mitsubishi	Tungaloy	Kyocera	Mitsubishi-Hitachi	Sandvik	Kennametal	SECO Tools	WALTER	ISCAR	Taegu Tec	NTK		
Turning	<b>M</b> <b>S</b>	M10 S10	<b>AC5005S</b> <b>AC5015S</b> <b>AC5025S</b> <b>ACZ150</b>	<b>New</b> MP9005 MP9015 VP15TF VP05RT VP10RT	AH110 AH710 AH725 AH905 AH8005	PR005S PR015S PR915 PR1025 PR1215 PR1225 PR1305 PR1310	IP050S IP100S JP9105 JP9115	H5D6 GC1105 GC1115	KCS10 KCS10B KC5510 KCU10	TH1000 TS2000	WSM01 WSM10 WSM10S	IC804 IC807 IC808 IC907 IC908	TT5080 TT3010 TT8010	TM1 VM1 DT4 DM4 ZM3 ST4		
		M20 S20	<b>AC1030U</b> <b>AC5015S</b> <b>AC5025S</b>	MP9015 MP9025 VP15TF VP20RT VP20MF UP20M MS9025	AH630 AH120 AH725 AH8015	PR015S PR915 PR930 PR1025 PR1125 PR1215 PR1225 PR1325	IP100S HS9115	GC15 GC1115 GC1125	KC5525 KCU25 KC5025	TS2500	WSM20 WSM20S	IC330 IC806 IC808 IC830 IC908 IC928	TT9080 TT9020 TT3020	DT4 DM4 ZM3 QM3 TM4 ST4		
		M30	<b>AC5025S</b> <b>AC6040M</b> <b>AC530U</b> <b>AC1030U</b>	MP7035 VP15TF VP20MF MS9025	AH630 AH645 AH725	PR1125 PR1525 PR1535			GC1125			WSM30 WSM30S	IC328 IC330 IC830 IC840 IC882	TT8020 TT8080 TT9080	QM3 TM4 DT4 DM4	
		M40	<b>AC6040M</b> <b>AC530U</b> <b>AC1030U</b>	MP7035 VP15TF MS6015	AH645	PR1125 PR1535	GX30						IC830 IC928	TT8020 TT8080		
	<b>K</b>	K10	<b>ACZ150</b> <b>AC1030U</b> <b>AC5015S</b>	VP10RT	AH110 AH120	PR905	HX3305 HG3305 HG3315 HX3515 HG8010 TH315		GC15				IC810	TT6080		
		K20	<b>ACZ150</b> <b>AC1030U</b> <b>AC5015S</b> <b>AC5025S</b>	VP10RT VP20RT VP15TF	AH120	PR905									TT6080	DM4 QM3
		K30	<b>AC1030U</b> <b>AC530U</b>	VP15TF VP20RT	AH110 AH120 AH725								IC830 IC908 IC910 IC928			
	Milling	<b>P</b>	P10	<b>ACU2500</b> <b>ACP200</b>	VP15TF MP6120	AH110 AH120 AH710 AH725	PR1225	PN215 PN15M JP4105 JP4115 JP4120 CY9020	GC1010	KC505M KC510M KC515M	F25M		IC807 IC903	TT2510 TT7080	DT4 DM4	
			P20	<b>ACP3000</b> <b>ACU2500</b> <b>ACP200</b> <b>ACP300</b>	VP15TF VP20RT MP6120 MP6130 UP20M	AH9030 AH120 AH725 AH3035 AH3225	PR1525 PR1225 PR1230 PR830	JP4120 CY150 CY1230 JS4045	GC1010 GC1025	KC522M KC525M KCSM30 SP6519	MP3000 F30M F32M F40M	WSM20 WSM20S	IC808 IC810 IC908 IC910	TT7080 TT9030 TT9080	TM4 DT4 DM4	
			P30	<b>ACP3000</b> <b>ACU2500</b> <b>ACP200</b> <b>ACP300</b>	VP15TF VP30RT MP6130 UP20M	AH3035 AH3135 AH3225 AH120 AH130 AH140 AH725	PR1525 PR1230 PR830	JS4045 JS4060 CY25 CY150 CY250 CY250V PTH30E		GC1030 GC1130 GC2030	KC725M KC735M KC525M KC530M KCPM40 KCSM30 SP6519	F40M T60M MP3000	WSM35 WSM35S WSP45 WSP45S	IC328 IC330 IC830 IC928	TT8080 TT8020	DM4 TM4 ZM3
P40			<b>ACP3000</b> <b>ACU2500</b> <b>ACP300</b>	VP30RT	AH140		JS4060 JM4160 PTH40H			KC725M KC735M KCPM40		WSP45 WSP45S	IC830 IC845 IC928	TT8020 TT8080 TT8525B		
<b>M</b>		M10 S10	<b>ACM100</b> <b>ACU2500</b> <b>ACK300</b> <b>ACP300</b>	MP9120 VP15TF	AH110 AH120 AH330 AH725 AH8005 AH8015	PR1025 PR1225	CY9020 JP4120 PN08M PN15M PN208 PN215	GC1010 GC1025 GC1030 GC1130	KC515M SP4019 SP6519				IC808 IC908		DT4 DM4 ZM3	
		M20	<b>ACM300</b> <b>ACU2500</b> <b>ACP300</b>	MP7030 MP7130 MP9120 MP9130 UP20M VP15TF VP20RT	AH120 AH130 AH330 AH725 AH3225 AH8015	PR1210 PR1225 PR1525 PR830	JP4120 CY150 JS1025	S30T	KC522M KC525M SP4019 SP6519 X700	F25M F30M T32M MP3000 MS2050 MM4500	WSM35 WSM35S	IC328 IC330 IC808 IC830 IC840 IC908 IC928	TT9080 TT9030	DT4 DM4 ZM3		
		M30	<b>ACM300</b>	MP7030 MP7130 MP7140 MP9130 VP15TF	AH130 AH140 AH330 AH725 AH3135	PR1525 PR1535 PR830	JM4160 PTH30E JS1025	GC2030 GC1040 S40T	KC522M KC525M KC725M KCPM40 KCSM30	F30M F32M F40M MP2050 MS2050	WSM35 WSM35S WSP45 WSP45S	IC328 IC330 IC830 IC840 IC882	TT8020 TT8080 TT9080	DT4 DM4 ZM3		
		M40	<b>ACM300</b>	MP7140 MP9140 VP30RT	AH140	PR1535	JM4160 PTH40H			KC725M KCPM40 KCSM40		WSP45 WSP45S	IC328 IC330 IC882	TT8020 TT8080		
<b>K</b>		K05	<b>ACK3000</b>	MP8010	AH110 AH710		TH303 TH308 ATH80D		GC1010	SP4019	MH1000					
		K10	<b>ACK3000</b> <b>ACU2500</b>	MP8010	AH110 AH120	PR1210	ATH10E TH315		GC1010 GC1020	KC514M SP4019	MH1000		IC810 IC910	TT7080 TT7515		
		K20	<b>ACK3000</b> <b>ACU2500</b> <b>ACK300</b>	MP8010 VP15TF	AH110 AH120 AH330 GH330	PR1210 PR1510	JP4120 PTH13S CY100H CY9020		GC1020 GC1025	KC514M KC524M KCK20 SP6519	MK2050 MK3000	WKK25S	IC808 IC810 IC830 IC908	TT6080 TT7515	DM4	
		K30	<b>ACK3000</b> <b>ACU2500</b> <b>ACK300</b>	VP15TF VP20RT	AH725 AH120 AH330 GH110 GH130 GH330	PR1510 PR1210	JS4045 CY150 CY250		GC1025 GC1030 GC1130	KC520M KC522M KC524M	MK2050		IC830 IC810 IC910 IC928	TT6080		

Grades

# Grade Comparison Chart

## ■ Cermet

Application	Class	Sumitomo Electric	Mitsubishi	Tungaloy	Kyocera	MOLDINO	Sandvik	Kennametal	SECO Tools	WALTER	ISCAR	Taegu Tec	
Turning	<b>P</b>	P10	<b>T1500Z*</b> <b>T1000A</b> <b>T1500A</b>	AP25N* NX2525 VP25N*	GT720* GT9530* GT9535* J9530* NS520	TN30 TN6020 TN610 TN620 PV710* PV720* CCX*	CZ25* CH550	CT5015	KT125 HTX KT1120		IC20N IC30N IC520N	PV3030 PV3010 CT3000	
		P20	<b>T1500Z*</b> <b>T2500Z*</b> <b>T3000Z*</b> <b>T1500A</b> <b>T2500A</b>	AP25N* NX2525 NX3035 MP3025*	AT9530* NS9530 GT9530* J9530*	TN90 TN620 TN6020 PV720* CCX*	CZ25* CH550	GC1525*	KT6215 KT315* KT175 KT5020*	CM CMP C15M TP1020		IC20N IC30N IC520N IC530N	CT7000
		P30	<b>T2500Z*</b> <b>T3000Z*</b> <b>T2500A</b>	MX2525 MP3025* VP45N	NS9530 GT9530* AT9530*	TN620 PV720* PV730*							
Milling	<b>K</b>	K10	<b>T1000A</b>	AP25N* VP25N* NX2525	GT720* GT9530* NS9530 J9530* NS520	TN610 PV7005* PV7010* CCX*	CH550	CT5015	KT125 HTX			PV3030 CT3000	
		P30	<b>T2500A</b> <b>T250A</b> <b>T4500A</b>	NX2525 MX3030 NX4545 VP45N*	NS540 NS740	TN60 TN90 TN100M TN620M	MZ1000* MZ2000* MZ3000* CH7030 CH7035	CT530	KT530M* KTPK20*	C15M		IC30N	

\* denotes coated cermet







## ■ Uncoated Carbide

Class	Grade	Sumitomo Electric	Mitsubishi	Tungaloy	Kyocera	MOLDINO	NTK	Sandvik	Kennametal	SECO Tools	ISCAR	Taegu Tec
<b>P</b>	P10	<b>ST10P</b>		TH10		WS10		S1P				
	P20	<b>ST20E</b>	UTi20T	KS20		EX35		SMA	K125M		IC70 IC50M	UF10
	P30	<b>A30N</b>	UTi20T	KS15F UX30	PW30	EX35 EX40		SM30			IC54 IC28	P30
	P40	<b>ST40E</b>		TX40		EX45		S6			IC54 IC28	
<b>M</b>	M10	<b>EH510</b>		TH10		EX35 WA10B	KM1	H10A	KU10 K313 K68 KYSM10	890	IC07 IC08 IC20	
	M20	<b>EH520</b>	UTi20T	KS20		EX35		H13A	K313 K68	HX 883	IC07 IC08 IC20	UF10
	M30	<b>A30</b> <b>A30N</b>	UTi20T	UX30				H10F SM30			IC28	
<b>K</b>	K01	<b>H2</b> <b>H1</b>	HTi05T	KS05F		WH01 WH05			KU10 K68 K313 K115M		IS8	
	K10	<b>H1</b> <b>EH510</b>	HTi10	TH10	KW10 GW15	WH10	KM1	H13A	KU10 K313 K68 K115M K110M KY3500	890	IC20 IS8	K10
	K20	<b>G10E, H10E</b> <b>EH520</b>	UTi20T	KS15F KS20	GW25	WH20	KM3	H13A	KMF KY3500 KYHS10	890 883 HX	IC20 IS8	
	K30	<b>G10E, H10E</b>	UTi20T			WH30			KY3500	883		
<b>S</b>	S10 S20	<b>EH510</b> <b>EH520</b>	RT9005 RT9010 MT9015 TF15	TH10 KS05F KS15F KS20	SW05 SW10 SW25 KW10 GW15	WH10		H10A H10F H13A	KU10 K313 K68 KMF K110M K1025 KYHS10	HX H25	IC20 IC07 IC08 IC28	K10
	Fine-grained Carbide	<b>A1</b>		UM		NM25		N6F H10F		883	IC08	

# Grade Comparison Chart

Grades

## ■ CBN

Class	Grade	Sumitomo Electric	Mitsubishi	Tungaloy	Kyocera	NTK	Chukyo	Sandvik	Kennametal	SECO Tools	ISCAR
<b>K</b>	K01	<b>NCB100</b> <b>BNC500*</b> <b>BN7000</b> <b>BN500</b>	MB710 MB5015	BX930 BX870 BX910	KBN475 KBN60M	B30 B16		CB7525 CB7925	KB1340		IB50 IB85
	K10	<b>BN7000</b> <b>BN500</b>	MB710 MB730 MB5015 MB4020	BX470 BX480 BX950	KBN60M KBN900	B23 B16	HB55 HB56 HB569 HB580 HB57	CB7925		CBN200 CBN300 CBN300P CBN400C	IB55 IB90
	K20	<b>BN700</b> <b>BN7000</b> <b>BNS800</b>	MB730 MB4020 MB4120 MBS140	BX470 BX480 BXC90 BX90S	KBN900		HB56 HB569 HB580 HB57				
	K30	<b>BNC8115</b>  <b>BNS8125</b>	MBA4120 MBS140 BC5030	BX90S BXC90			HB57		KB5630	CBN500	
<b>S</b>	S01	<b>NCB100</b> <b>BN7000</b>	MB730 MB4020 MB4120	BX940 BX950 BX470 BX480			HB55 HB580 HB52		KB5630 KB1340		IB85 IB05S IB10S
<b>H</b>	H01	<b>BNC2010</b>  <b>BNC2115</b> <b>BN1000</b> <b>BN2000</b>	BC8105 BC8110 MBC010 MB810 MB8110	BXA10 BXM10 BX310	KBN05M KBN25M KBN510	B5K B52	HB55 HB550 HB580 HB590	CB7105	KB5610	CH0550 CBN10 CBN100 CBN60K	IB05H IB50 IB10HC
	H10	<b>BNC2010</b> <b>BNC2020</b>  <b>BNC2115</b>  <b>BNC2125</b>  <b>BN2000</b>	BC8110 BC8120 MBC020 MB8025 MB8110 MB825	BXA10 BXM10 BX330 BX530	KBN05M KBN25M KBN525	B5K B6K B52 B36	HB55 HB59 HB550 HB580 HB52	CB7015 CB7115 CB20	KBH20 KB5610 KB5625	CBN10 CBN150 CBN100 CBN060K CBN160C	IB10H IB55 IB25HA
	H20	<b>BNC2020</b>  <b>BNC2125</b> <b>BNX20</b>	BC8120 BC8020 MBC020 MB8025 MB8120	BXA20 BXM20 BX360	KBN30M KBN35M KBN900	B36 B40 B6K	HB57 HB59 HB590 HB580	CB7025 CB7125 CB50	KBH20 KB5625 KB5630	CH2540 CBN150 CBN160C	IB20H IB20HC IB25H IB25HC
	H30	<b>BNC300</b> <b>BN350</b> <b>BNX25</b>	MB835 MB8130 BC8130	BXM20 BXA20 BXC50 BX380	KBN30M KBN35M KBN900	B40	HB57 HB580	CB7525 CB7135	KB5630	CH3515	IB90

## ■ PCD

Class	Grade	Sumitomo Electric	Mitsubishi	Tungaloy	Kyocera	NTK	Chukyo	Sandvik	Kennametal	SECO Tools	ISCAR
<b>N</b>	N01	<b>DA90</b> <b>DA1000</b>	MD205	DX180 DX160	KPD001	PD1		CD05 CD10	KD1400		ID5
	N10	<b>DA150</b> <b>DA1000</b>	MD205 MD220	DX140	KPD001 KPD010 KPD230	PD2	HD100 HD30 HD60	CD1810	KD1400 KD1425	PCD05 PCD10	ID5
	N20	<b>DA1000</b> <b>DA2200</b>	MD220 MD230	DX120 DX110	KPD230	PD2	HD100 HD30 HD50		KD1400 KD1425	PCD05 PCD20	
	N30	<b>DA1000</b> <b>DA2200</b>	MD2030 MD230	DX110			HD30 HD50 HD700 HC100		KD1400	PCD05 PCD30 PCD30M	



# Indexable Inserts for Turning

## Negative / Positive Inserts

C1–C96



Inserts

C

D

K

R

S

T

V

W

	ISO Inserts Identification Table.....	C2–3
General-purpose Chipbreaker for M-class Positive Inserts	<b>NGU</b> <sup>New</sup> .....	C4–5
Chipbreaker for Low Carbon and General Steel Turning	<b>NFE / NFB</b> .....	C6
Chipbreaker for Hardened Steel Turning	<b>NGH</b> .....	C7
Chipbreaker for Exotic Alloys and Stainless Steel Turning	<b>NEG / NEF</b> .....	C8–9
Chipbreaker for Stainless Steel Turning	<b>NEM</b> .....	C10
Positive M Class Chipbreaker	<b>NFB / NLB</b> .....	C11
Chipbreaker for Steel Turning	<b>(M) NSI</b> .....	C12
Comparison Chart	<b>Chipbreaker</b> .....	C13
Selection	<b>Chipbreaker Application Table</b> .....	C14–19
Negative Inserts	<b>C / 80° Diamond Type (With Hole)</b> .....	C20–28
	<b>D / 55° Diamond Type (With Hole)</b> .....	C29–36
	<b>S / Square Type (With Hole)</b> .....	C37–44
	<b>S / Square Type (Without Hole)</b> .....	C45
	<b>T / Triangle Type</b> .....	C46–54
	<b>T-REX Insert</b> .....	C52
	<b>V / 35° Diamond Type (With Hole)</b> .....	C55–57
	<b>W / Polygon Type (With Hole)</b> .....	C58–62
Positive Inserts	<b>C / 80° Diamond Type (With Hole)</b> .....	C63–69
	<b>D / 55° Diamond Type (With Hole)</b> .....	C70–73
	<b>R / Round Type (With Hole)</b> .....	C74
	<b>S / Square Type (With Hole)</b> .....	C75–78
	<b>S / Square Type (Without Hole)</b> .....	C79
	<b>T / Triangle Type (With Hole)</b> .....	C80–87
	<b>T / Triangle Type (Without Hole)</b> .....	C86–89
	<b>V / 35° Diamond Type (With Hole)</b> .....	C90–93
	<b>W / Polygon Type (With Hole)</b> .....	C94–95

### Stock marking chart

- : Euro stock item
- : Japan stock item
- ▲ : To be replaced by new item

☐ : We cannot produce

#### Note:

Stocking policy may change without prior notice, please consult our sales representative for actual stock situation.



# Inserts Identification Table

Inserts  
C  
D  
K  
R  
S  
T  
V  
W

**C**      **N**      **M**      **G**

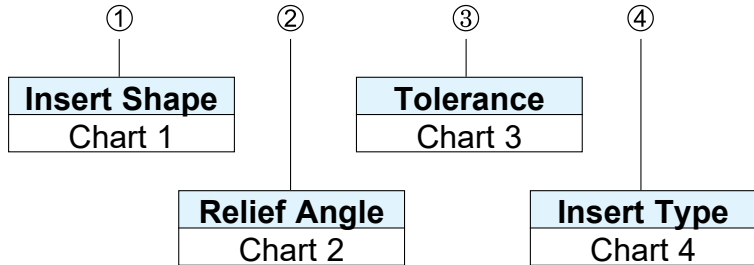

**Chart 1: Insert Shape**

Symbol	Insert Shape	Angle
C		80°
D		55°
E		75°
F		50°
V		35°
R		Round
S		Square
T		Triangle
W		Trigon
A		85°
B		82°
K		55°
H		Hexagonal
O		Octagonal
P		Pentagonal
L		Rectangular
M		Rhombic

**Chart 2: Relief Angle**

Symbol	Relief Angle
A	3°
B	5°
C	7°
D	15°
E	20°
F	25°
G	30°
N	0°
P*	11°
O	Others

\* Inserts with a 10° relief angle are sometimes considered as "P"

**Chart 3: Tolerance (mm)**

Symbol	Nose Height	Inscribed Circle	Thickness
A	± 0,005	± 0,025	± 0,025
F	± 0,005	± 0,013	± 0,025
C	± 0,013	± 0,025	± 0,025
H	± 0,013	± 0,013	± 0,025
E	± 0,025	± 0,025	± 0,025
G	± 0,025	± 0,025	± 0,13
J*	± 0,005	±0,05 – ±0,15	± 0,025
K*	± 0,013	±0,05 – ±0,15	± 0,025
L*	± 0,025	±0,05 – ±0,15	± 0,025
M*	±0,08 – ±0,2	±0,05 – ±0,15	± 0,13
N*	±0,08 – ±0,2	±0,05 – ±0,15	± 0,025
U*	±0,13 – ±0,38	±0,08 – ±0,25	± 0,13

The height "m" on sharp corner.

**Chart 4: Insert Hole or Breaker**

Symbol	Hole	Hole Style	Chip Breaker	Shape	Symbol	Hole	Hole Style	Chip Breaker	Shape
N	No Hole	—	Nil		A	With Hole	Straight Hole	Nil	
R	No Hole		One Face		M			One Face	
F			Both Faces		G			Both Faces	
W	With Hole	Straight hole with top end counter-sink (40°-60°)	Nil		B	With Hole	Straight hole with top end counter-sink (70°-90°)	Nil	
T			One Face		H			One Face	
Q	With Hole	Straight hole with top end counter-sink (40°-60°)	Nil		C	With Hole	Straight hole with top end counter-sink (70°-90°)	Nil	
U			Both Faces		J			Both Faces	
					X	—	—	—	Special

● **Tolerance of Nose Height (M-Class)**

Inscribed Circle	Triangle	Square	80° Diamond	55° Diamond	35° Diamond	Round
6,35	± 0,08	± 0,08	± 0,08	± 0,11	—	—
9,525	± 0,08	± 0,08	± 0,08	± 0,11	± 0,16	—
12,70	± 0,13	± 0,13	± 0,13	± 0,15	—	—
15,875	± 0,15	± 0,15	± 0,15	± 0,18	—	—
19,05	± 0,15	± 0,15	± 0,15	± 0,18	—	—
25,40	± 0,18	± 0,18	± 0,18	—	—	—
31,75	—	± 0,20	—	—	—	—

● **Tolerance of Inscribed Circle (M-Class)**

Inscribed Circle	Triangle	Square	80° Diamond	55° Diamond	35° Diamond	Round
6,35	± 0,05	± 0,05	± 0,05	± 0,05	—	—
9,525	± 0,05	± 0,05	± 0,05	± 0,05	± 0,05	± 0,05
12,70	± 0,08	± 0,08	± 0,08	± 0,08	—	± 0,08
15,875	± 0,10	± 0,10	± 0,10	± 0,10	—	± 0,10
19,05	± 0,10	± 0,10	± 0,10	± 0,10	—	± 0,10
25,40	± 0,13	± 0,13	± 0,13	—	—	± 0,10
31,75	—	± 0,15	—	—	—	± 0,12

# Inserts Identification Table

## 12 04 08 N - GE

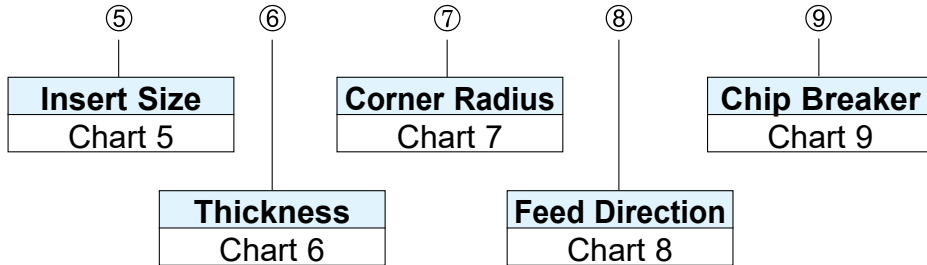

Picture of insert shown as example  
(ISO Cat, No.)



Inserts

**Chart 5: Cutting Edge Length (mm)**

Shape	Symbol	Cutting Edge	Inscribed Circle	Shape	Symbol	Cutting Edge	Inscribed Circle	Shape	Symbol	Cutting Edge		Inscribed Circle		
										Neg.	Pos.	Neg.	Pos.	
C	03	3,55	3,50	D	07	7,7	6,35	W	03	3,8	5,56			
	04	4,97	4,30		09	9,7	7,94		04	4,3	6,35			
	06	6,4	6,35		11	11,6	9,525		05	5,4	7,94			
	08	8,0	7,94		15	15,5	12,70		06	6,5	9,525			
	09	9,7	9,525		19	19,4	15,875		08	8,7	12,70			
	12	12,9	12,70						10	10,9	15,875			
	16	16,1	15,875		V	08	8,3		4,76	11	4,3	6,35		
	19	19,3	19,05			09	9,7		5,56	16	6,5	9,525		
	25	25,8	25,4			11	11,1		6,35	08	8,0	8,0		
						16	16,6		9,525	10	10,0	10,0		
			22	22,1		12,7	12	12,0	12,0					
S	06	6,35	6,35	T	06	6,9	3,97	R	12	12,70	12,70			
	S7	7,14	7,14		08	8,2	4,76		15	15,875	15,875			
	07	7,94	7,94		09	9,6	5,56		16	16,0	16,0			
	09	9,525	9,525		11	11,0	6,35		19	19,05	19,05			
	12	12,70	12,70		13	13,7	7,94		20	20,0	20,0			
	15	15,875	15,875		16	16,5	9,525		24	24,0	24,0			
	19	19,05	19,05		22	22,0	12,70		25	25,0	25,0			
	25	25,40	25,40		27	27,5	15,875		25	25,40	25,40			
	31	31,75	31,75		33	33,0	19,05		32	32,0	32,0			

**Chart 6: Thickness**

Symbol	Thickness (mm)
X1	*
01	1,59
02	2,38
T2	2,78
03	3,18
T3	3,97
04	4,76
05	5,56
06	6,35
07	7,94
09	9,52

(\*):  
CCET03X1 Insert thickness: 1,40  
CCET04X1 Insert thickness: 1,80

**Chart 7: Nose Radius**

Symbol	Nose Radius (mm)
00	Sharp Point
003	0,03
008	0,08
01	0,1
015	0,15
018	0,18
02	0,2
0,35	0,35
04	0,4
08	0,8
10	1,0
12	1,2
16	1,6
20	2,0
24	2,4
32	3,2
M0	Round Insert (Metric)
00	Round Insert (Imperial)

An "M" after the nose radius indicates a negative tolerance  
Example:  
CCG T09T302 M NSI AC520U

**Chart 8: Feed Direction**

Symbol	Direction
R	Right-hand
L	Left-hand
N	Neutral

**Chart 9: Chip Breaker**

Symbol	Process	Bumpy Type	Standard	Handed
F	Fine Finishing to Finishing	FA, FL, FE, FB, FC FK, FP		FT, FX, FZ FY, FW
S	Light Cut	SE, SEW, SI, SC, SF, SP, SU, SX		SD SDW ST
L		LU, LUW, LB		
G	General	GE, GU, GUW	GZ	UM
U		UG, UP US, UX	UZ	
M	Rough	MP, MU, MX, ME	MC	MM HM
H	Heavy	HG, HP, HF	HU HW	

Other Specials	
Wide Chipbreaker	W
For Countersink	C
For Round insert	RD, RP, RX, RH
For Exotic Alloy	EF, EG, EX, EM
For Aluminium	AW, AG, AX, AY, LD, GD,
For Hardened Steel	FV, LV, GH
For Carburized Layer Removal	SV
For Stainless Steel	EF, EG, EM

- C
- D
- K
- R
- S
- T
- V
- W

# Chipbreaker NGU Type

**New**

For positive Inserts

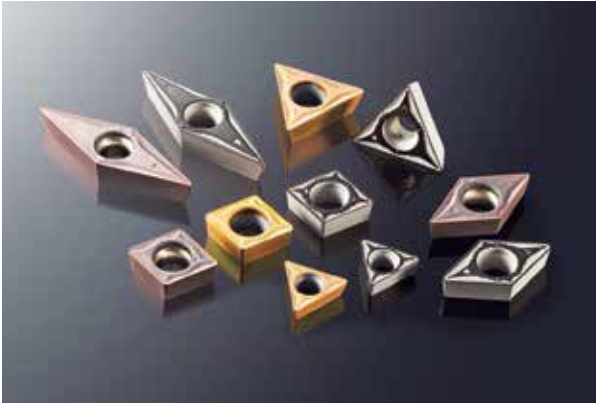

## General Features

Superb versatility handles processes from roughing to finishing.  
Stable machining is realised across a range of conditions through excellent cutting edge sharpness and strength.  
Item range covers a wide variety of applications.

C

## NGU-Chipbreaker for Positive Inserts

D

Excellent chip control performance

K

- Wide chip pocket for various cutting conditions

R

Less Vibration

S

- Improved chip control in a wide application field

T

V

Suppresses chip jamming at high feed rates  
for ideal chip control

W



- Wide restraining face enables consistent chip control for light to medium cutting.

- Discharges chips well under high feed conditions and suppresses build-up

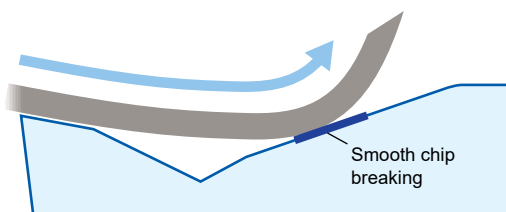

- Achieves stable machining with both versatility and low resistance

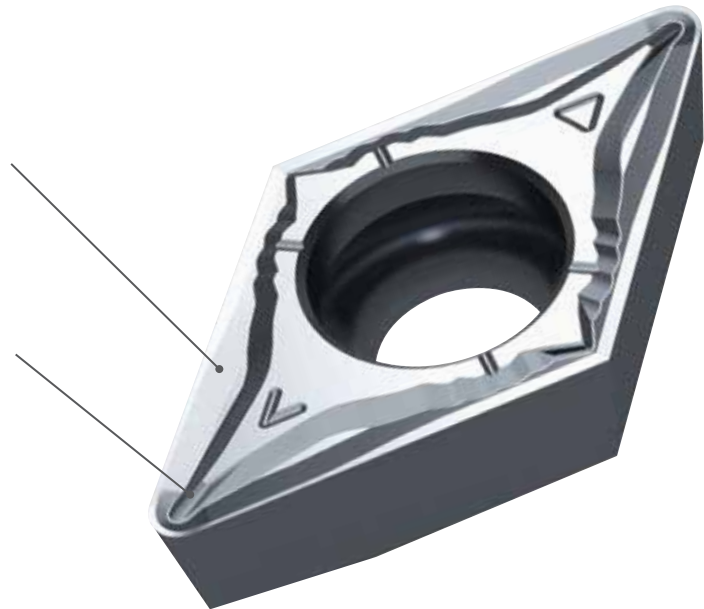

## Improved Fracture Resistance

The two step rake angle geometry ensures outstanding sharpness and hardness.

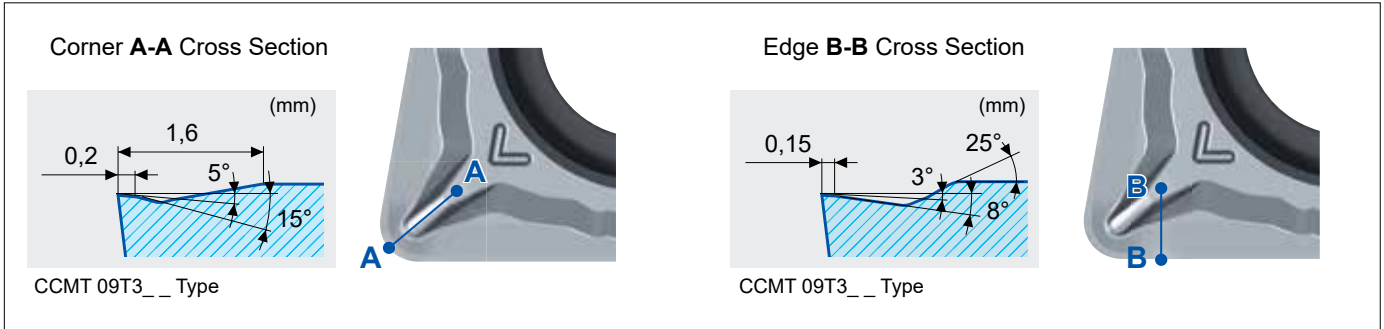

## Application Range

Enhanced application range over conventional products.

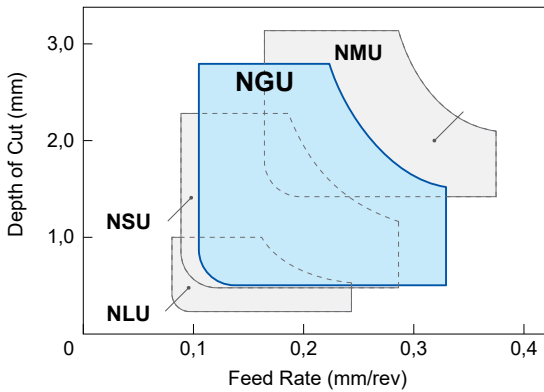

## Application Examples

**24CrMo5, Automotive Parts**

Improves chip entanglement for improved machining efficiency.

$a_p = 2,0$ (1 pass)	$a_p = 2,0$ (1 pass)
$a_p = 1,0$ (2 passes)	$a_p = 1,0$ (2 passes)

**NGU**      **Conventional**

Chattering occurs  
Not applicable

Insert: CPMT 090308 NGU (AC8025P)  
 Cutting Conditions:  $v_c = 200$  m/min,  $f = 0,2$  mm/rev,  $a_p = 2,0$  mm, wet, internal taper boring

**15CrMo5, Fastening Parts**

Strong cutting edge design realizes 1,5 times the tool life.

**NGU**      **Competitor B**

Insert: CCMT 09T308 NGU (AC8025P)  
 Cutting Conditions:  $v_c = 190$  m/min,  $f = 0,25$  mm/rev,  $a_p = 1,0$  mm, wet, internal boring

- C
- D
- K
- R
- S
- T
- V
- W

# Chipbreaker NFE Type / NFB Type

## Negative M Class Chipbreakers for Low Carbon and General Steel Turning

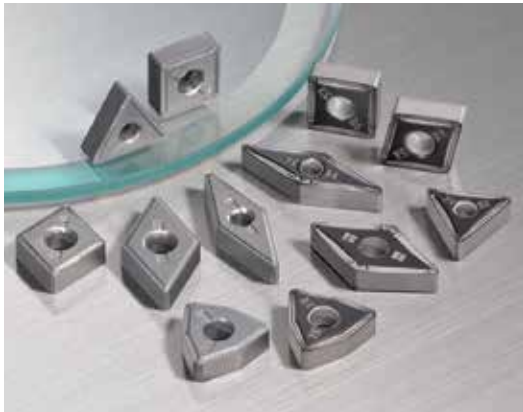

### General Features

The high performance NFE type, which ensures stable chip control in a wide range of feed rate, has been added to the chipbreaker series for low carbon steel and general steel turning. Extensive product lines are available to meet various machining requirements. A positive insert execution of chipbreaker NFB is also available.

### Application Range

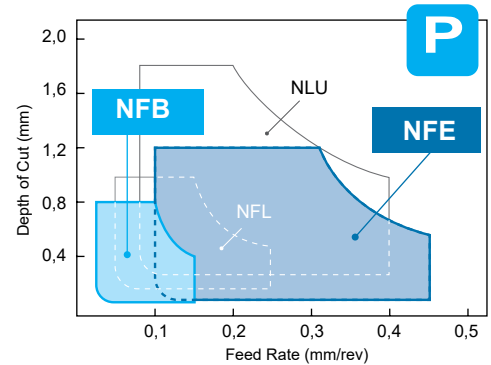

### NFE Chipbreaker for Finishing

Supports general purpose machining to high speed machining.

The arc-shaped main breaker ensures stable chip control in a wide feed rate range.

The two step chipbreakers enable stable chip control at a low feed rate of  $f = 0,1$  mm/rev.

The sub-breaker controls cutting chips in profiling.

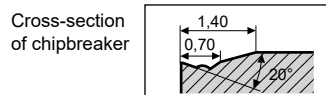
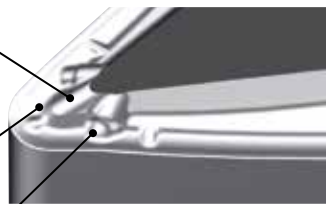

### Performance

Work Material: Pipe steel (H240LA, 1.0480)  
Insert: CNMG 120408 NFE (AC8025P)  
Cutting Conditions:  $v_c=200$  m/min,  $f=0,4$  mm/rev,  $a_p=0,2$  mm, dry

Excellent chip control under low depth of cut and high feed rate condition



NFE Type (AC8025P)

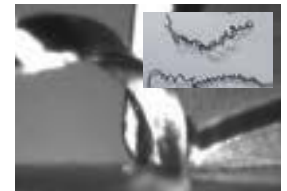

Conventional

### Application Examples

Work Material: Deep-draw steel (SPHC440)  
Facing Insert: CNMG 120408 NFE (AC8025P)  
Cutting Conditions:  $v_c = 200$  m/min,  $f = 0,15$  mm/rev,  $a_p = 0,2-0,5$  mm, wet

Stable chip curling and breaking in facing of gummy steel.



NFE Type (AC8025P)

Competitor

Work Material: C53E, 1.1210, Ø20-100  
Exter. Turning+Facing Ins.: DNMG 150412 NFE (AC8025P)  
Cutting Conditions:  $v_c=180$  m/min,  $f=0,25$  mm/rev (radius), 0,45 mm/rev (straight section),  $a_p = 0,3$  mm, wet

Stable chip control even at a variable feed rate in shallow cutting.



NFE Type (AC8025P)



Conventional

### NFB Chipbreaker for Low Feed Finishing

Supports low feed machining.

Smooth chipbreaker geometry with a high rake reduces cutting resistance.

The variable rake angle in nose radius makes effective strain on chips and improves the breaking performance.

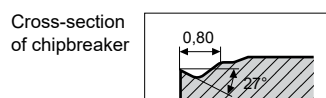

### Application Example

Work Material: Pipe steel (STKM13C)  
Internal Turning Insert: DNMG 150404 NFB (T3000Z)  
Cutting Conditions:  $v_c = 352$  m/min,  $f = 0,03-0,2$  mm/rev,  $a_p = 0,7$  mm, wet

Small chip curling and control



NFB Type (T3000Z)



Competitor





## General Features

Enables medium roughing of hardened steel in combination with coating and grade AC503U.

Reduces heat generation and enables deep cutting ( $a_p = 1-3$  mm) of hardened steel by using a wide neutral ground chipbreaker (rake angle:  $4^\circ$ ) and sharp edge.

Discharges chips smoothly.



## Negative Insert for Rough Cutting NGH Type Chipbreaker

### Performance

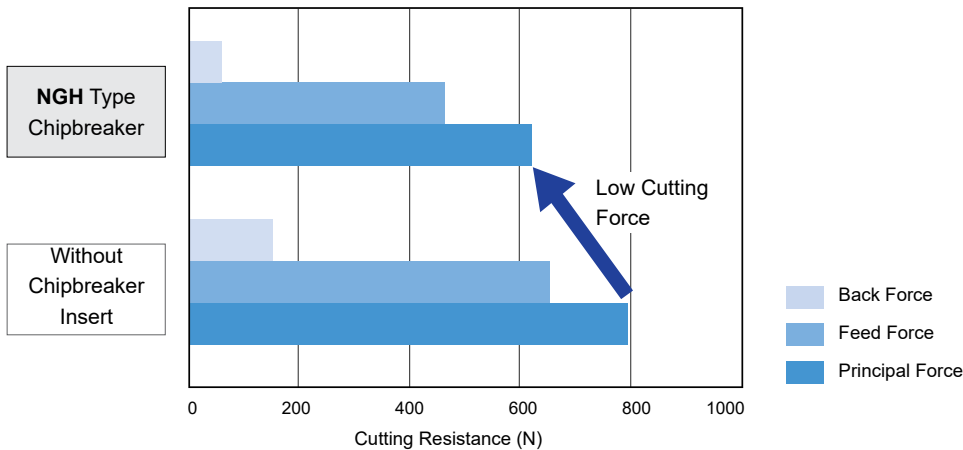

### Application Examples

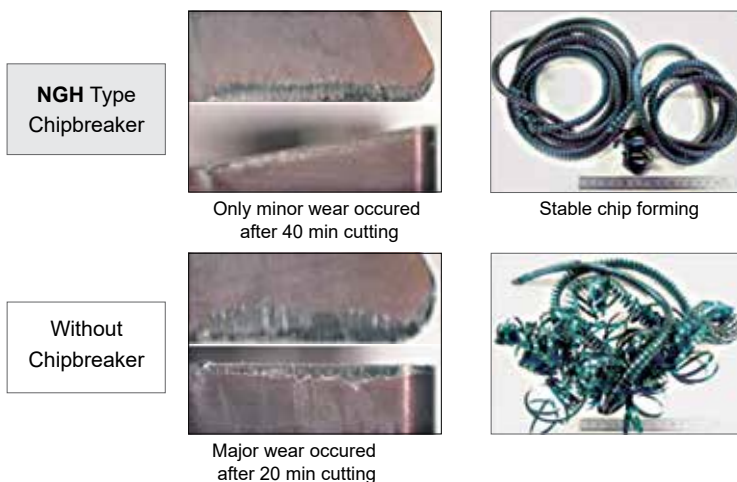

Work Material: X155CrVMo12-1 (61HRC)  
 Insert: TNGG 160404 NGH (AC503U)  
 Cutting Conditions:  $v_c = 50$  m/min,  $f = 0,05$  mm/rev,  $a_p = 3,0$  mm, dry

### Recommended Cutting Conditions

Application Range	Cutting Speed $v_c$ (m/min)	Feed Rate $f$ (mm/rev)	Depth of Cut $a_p$ (mm)	Recommended Chipbreaker
Finishing	40-100	0,02-0,10	<1	Without chipbreaker
Medium Roughing	20-60	0,02-0,05	1-3	NGH Type

Work Material: Hardened steel (50-62 HRC), X155CrVMo12-1, X40CrVMo5-1, S6-5-2, High-speed powder and high speed steel



# Chipbreaker NEG Type / NEF Type

For Exotic Alloys and Stainless Steel Turning

## General Features

NEG/NEF type chipbreaker for exotic alloy machining can be used for Titanium alloys, heat-resistant alloys and a variety of other exotic alloys. They deliver excellent wear resistance and superior chip management. These chipbreakers can solve quality problems caused by the unstable tool life and poor chip control provided by conventional chipbreakers for exotic alloys.

## Application Range

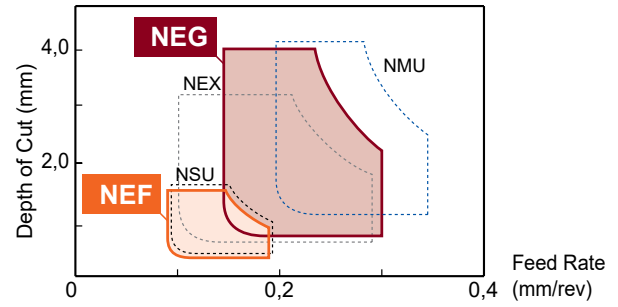

## NEG Chipbreaker for Roughing

Provides excellent wear resistance and chip control from general-purpose machining to roughing applications. Reduces damage to insert and eliminates trouble from chips specific to exotic alloys. Also demonstrates very high versatility.

Crater wear advancement is prevented by the round bumps, whilst maintaining excellent control.

The cutting edge maintains the strength slowing the progress of crater wear.

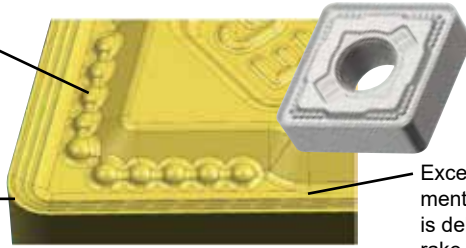

Excellent chip management and wear prevention is delivered by the special rake face design.

Cross Section of Chipbreaker

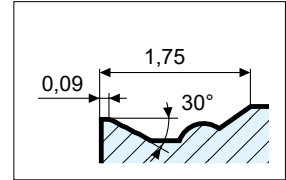

## Cutting Performance – NEG Type

### Heat Resistant Alloy

Chipbreaker type: NEG (AC510U)



Suppresses the chipping of peripheral cutting edge and notch wear. Excellent chip management.

Work Material: Inconel 718

Insert: CNMG120412

Cutting Data:  
 $v_c = 40$  m/min  
 $a_p = 2,5$  mm  
 $f = 0,2$  mm/rev  
wet  
 $T_c = 7$  min

Conventional tool (S10)



Notch wear / poor chip control

### Titanium Alloy

Chipbreaker type: NEG (AC510U)



Suppresses crater wear and flank wear. Excellent chip management.

Work Material: Ti-6Al-4V

Insert: CNMG120412

Cutting Data:  
 $v_c = 65$  m/min  
 $a_p = 2,5$  mm  
 $f = 0,2$  mm/rev  
wet  
 $T_c = 8$  min

Conventional tool (S10)

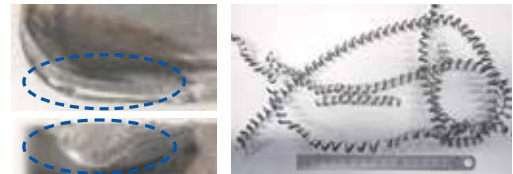

Crater wear / flank wear / poor chip control

## Application Example – NEG Type

Inconel 718, machine component

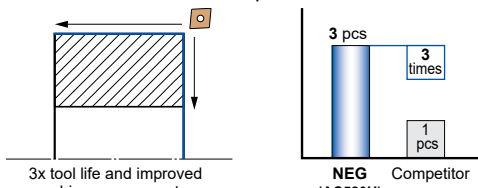

Insert: CNMG120408 NEG (AC520U)  
Cutting Data:  $v_c = 50$  m/min,  $a_p = 1,5$  mm,  $f = 0,3$  mm/rev, wet

Pure Titanium (Ti grade 3), machine component

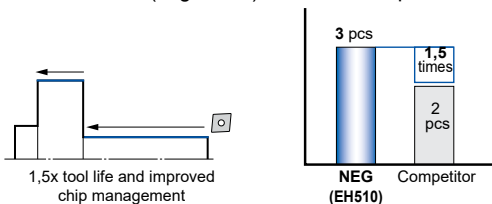

Insert: CNMG120408 NEG (EH510)  
Cutting Data:  $v_c = 80-100$  m/min,  $a_p = 1,0$  mm,  $f = 0,25$  mm/rev, wet

# Chipbreaker NEG Type / NEF Type

## For Exotic Alloys and Stainless Steel Turning

### Material Application Range

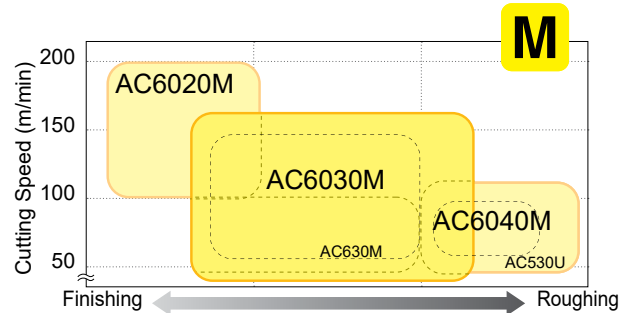
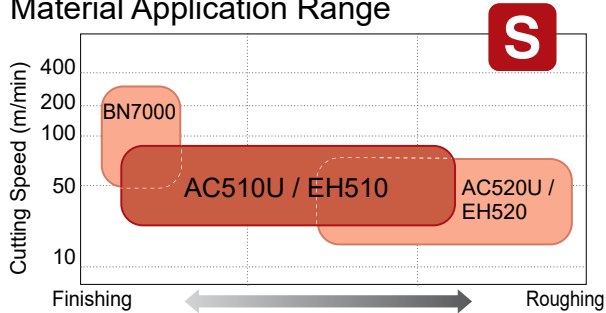

### NEF Chipbreaker for Finishing

The NEF chipbreaker reduces chip curl diameter in finishing applications. Provides extremely good chip management not fluctuated by the material in use.

Main chipbreaker that enables good chip control even at low depths of cut.

Sharp edge with 20° rake angle reduces wear.

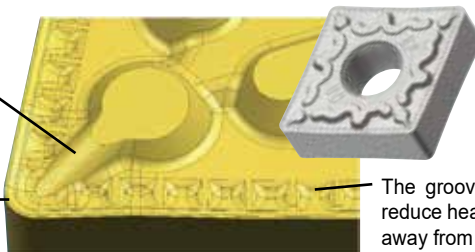

The grooves on the rake face reduce heat and assist chip flow away from the workpiece.

Cross Section of Chipbreaker

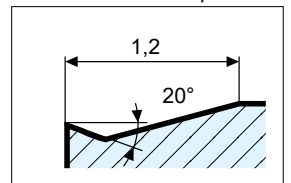

### Cutting Performance – NEF Type

#### Heat Resistant Alloy

Chipbreaker type: NEF (AC510U)

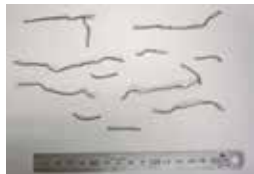

Improvements in chip control and chip removal management based on small curled chips.

Work Material: Inconel 718

Insert: CNMG120408

Cutting Data:  
 $v_c = 55$  m/min  
 $a_p = 0,3$  mm  
 $f = 0,15$  mm/rev  
 wet  
 $T_c = 8$  min

Conventional tool (S10)

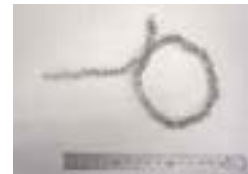

Competitor's product (S10)



There is a problem in the length and the diameter of chips.

#### Titanium Alloy

Chipbreaker type: NEF (AC510U)



Improvements in chip control and chip removal management based on small curled chips.

Work Material: Ti-6Al-4V

Insert: CNMG120408

Cutting Data:  
 $v_c = 80$  m/min  
 $a_p = 0,5$  mm  
 $f = 0,2$  mm/rev  
 wet  
 $T_c = 25$  min

Conventional tool (S10)



Competitor's product (S10)



There is a problem in the length and the diameter of chips.

### Application Example – NEF Type

Inconel 718, shaft component

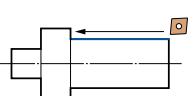

Great improvement in chip management. Keeps workpieces free of damage. It is possible to omit final polishing process.



NEF (AC510U)



Conventional tool

Insert: CNMG120408 NEF (AC510U)  
 Cutting Data:  $v_c = 45$  m/min,  $a_p = 0,25$  mm,  $f = 0,1$  mm/rev, wet

Duplex stainless steel cover

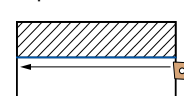

Improvements in chip management. Suppress damage to finished surface with no entanglement of chips.



NEF (AC510U)



Conventional tool

Insert: CNMG120408 NEF (AC510U)  
 Cutting Data:  $v_c = 55$  m/min,  $a_p = 0,3$  mm,  $f = 0,125$  mm/rev, wet

# Chipbreaker NEM Type

## Chipbreaker for Stainless Steel Turning

### Application Range

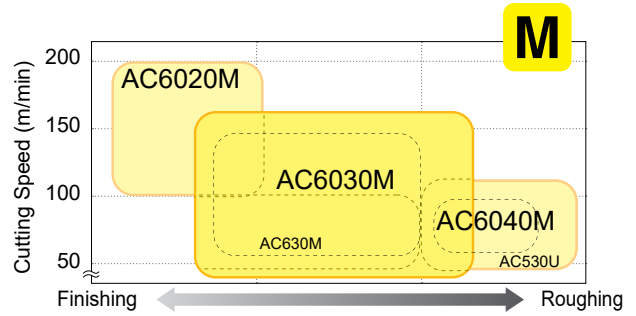
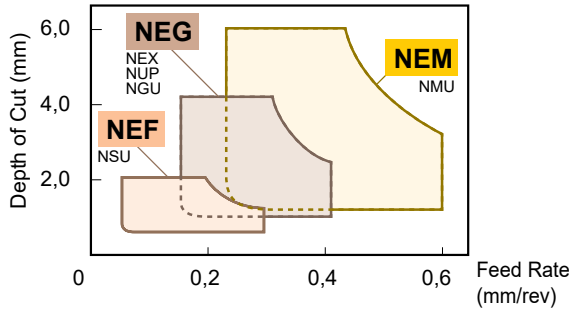

### NEM Chipbreaker for Rough Cutting

The NEM chipbreaker achieves excellent fracture and crater resistance and ensures extremely stable machining.

Large radius rake face design that reduces crater wear while maintaining the cutting edge strength.



Bright colors for easy identification of used cutting edge.

Reduces boundary damage by eliminating changing points from the cutting edge.

### Reduction of Damage

	Reduction of Boundary Damage		Reduction of Crater Wear	
	Cutting Edge	Boundary Wear Comparison	Cross Section	Crater Wear Comparison
Conventional Geometry				
NEM Type				
	The NEM chipbreaker has no changing points on the cutting edge, so boundary damage is reduced.		The NEM chipbreaker smoothly evacuates chips thanks to its large radius rake face design, so crater wear is reduced.	

### Application Example

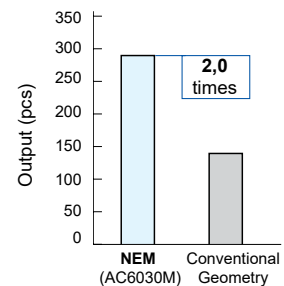
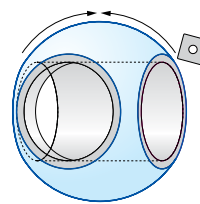
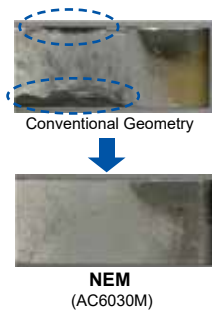
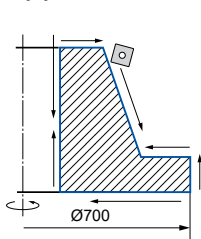

Reduces breakage out of the cutting edge and ensures stable machining.

Reduces crater wear and provides long tool life.

Work Material: X5CrMo17 12 2  
Insert: SNMG190616NEM (AC6030M)  
Cutting Conditions:  $v_c = 70$  m/min,  $f = 0,5$  mm/rev,  $a_p = 3,0-8,0$  mm, wet

Work Material: X5CrNiS18 10  
Insert: SNMG120408NEM (AC6030M)  
Cutting Conditions:  $v_c = 100$  m/min,  $f = 0,32$  mm/rev,  $a_p = 2,0-2,5$  mm, wet

# Positive M Class Chipbreakers for Low Carbon and General Steel Turning

# Chipbreaker NFB Type / NLB Type

## Application Range

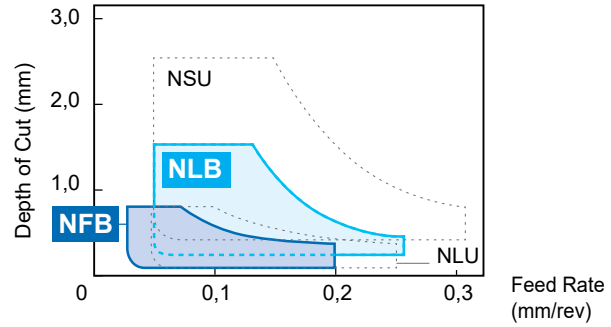
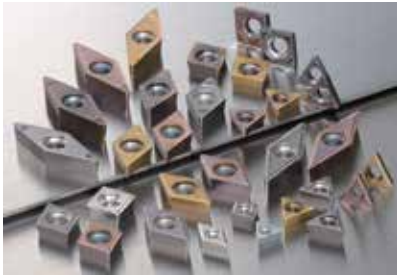

### NFB Chipbreaker for Finishing

The NFB type for finishing and the NLB type for light cutting have been added to the chipbreaker series for low carbon and general steel machining in addition to the already present NLU type for finishing and NSU type for light cutting. The NFB and NLB type chipbreakers improve chip control in finishing of low carbon and general steel.

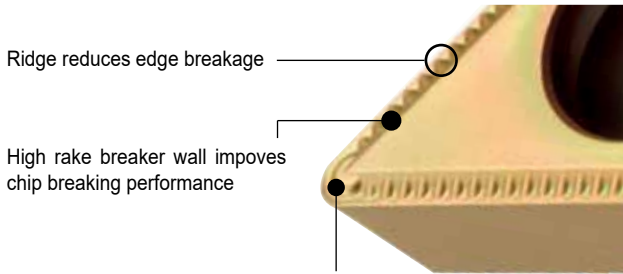

Variable rake angle in nose radius increases chip strain and improves chip breaking performance

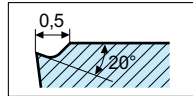

Cross Section of Chipbreaker

### NLB Chipbreaker for Light Cutting

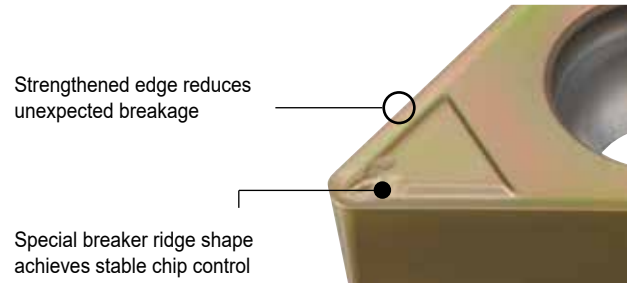

Special breaker ridge shape achieves stable chip control

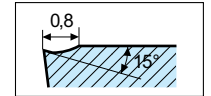

Cross Section of Chipbreaker

## Performance

### Chip Control

Achieves stable chip control at small cutting depth and low feed.

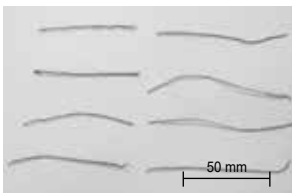

NFB Type Chipbreaker (T1500A)



Competitor's Product

Work Material: Pipe (H240LA), Ø 30 Boring  
Insert: TPMT 110304 NFB (T1500A)  
Cutting Conditions:  $v_c = 100$  m/min,  $f = 0,12$  mm/rev,  $a_p = 0,1$  mm, wet

## Performance

### Chip Control ①

Achieves stable chip control in light cutting.



NLB Type Chipbreaker (T1500A)



Competitor's Product

Work Material: Pipe (H240LA), Ø 30 Boring  
Insert: TPMT 110304 NLB (T1500A)  
Cutting Conditions:  $v_c = 200$  m/min,  $f = 0,15$  mm/rev,  $a_p = 0,5$  mm, wet

### Comparison of Surface Roughness of Finished Surfaces

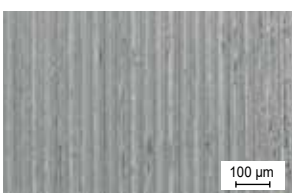

NFB Type Chipbreaker (T1500A)



Competitor's Product

Work Material: Pipe (H240LA), Ø 100 Boring  
Insert: TPMT 110304 NFB (T1500A)  
Cutting Conditions:  $v_c = 200$  m/min,  $f = 0,07$  mm/rev,  $a_p = 0,1$  mm, wet

### Chip Control ②

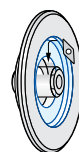

NLB Type Chipbreaker (T1500A)



Competitor's Product



Doubles the tool life by improving chip control and reducing blemishes on machined surfaces.

Work Material: Hub (C45)  
Insert: VBMT 160408 NLB (T1500A)  
Cutting Conditions:  $v_c = 240$  m/min,  $f = 0,25-0,28$  mm/rev,  $a_p = 0,6$  mm, wet

Inserts

C

D

K

R

S

T

V

W



# Chipbreaker for Steel Turning (M)NSI Type

Nose radius with minus tolerance (M)

Example: DCGT 11T304M NSI

## Application Range

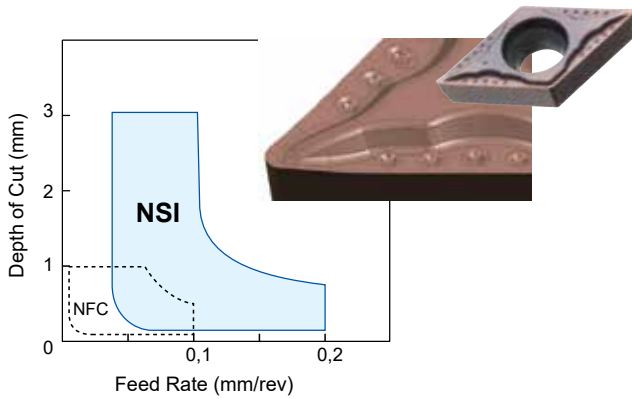

## Cutting Performance

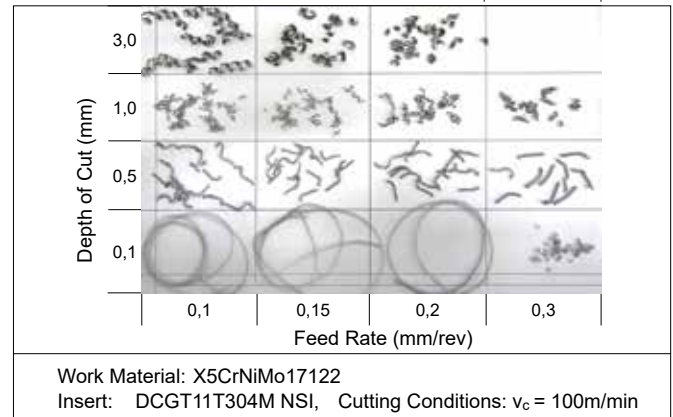

## Application Examples

Inconel 718, machine component external turning

1,5 x higher tool life. Improved chip management.

Insert: DCGT11T302M NSI (AC510U)  
Cutting Conditions:  $v_c = 35$  m/min,  $f = 0,08$  mm/rev,  $a_p = 0,8$  mm, wet

X5CrNi1810, Shaft component external turning & facing

Improved chip management. Suppressing cutting edge adhesion to ensure a stable, long tool life.

Insert: DCGT11T304M NSI (AC520U)  
Cutting Conditions:  $v_c = 100$  m/min,  $f = 0,08$  mm/rev,  $a_p = 0,5$  mm, wet

- Sharp designed cutting edge with low-cutting force
- Better chip control in wide range DOC for bar feeder machine
- Combination of high rake edge design and G-class precision offers superior cutting performance
- Suitable for medical parts and high precision machining

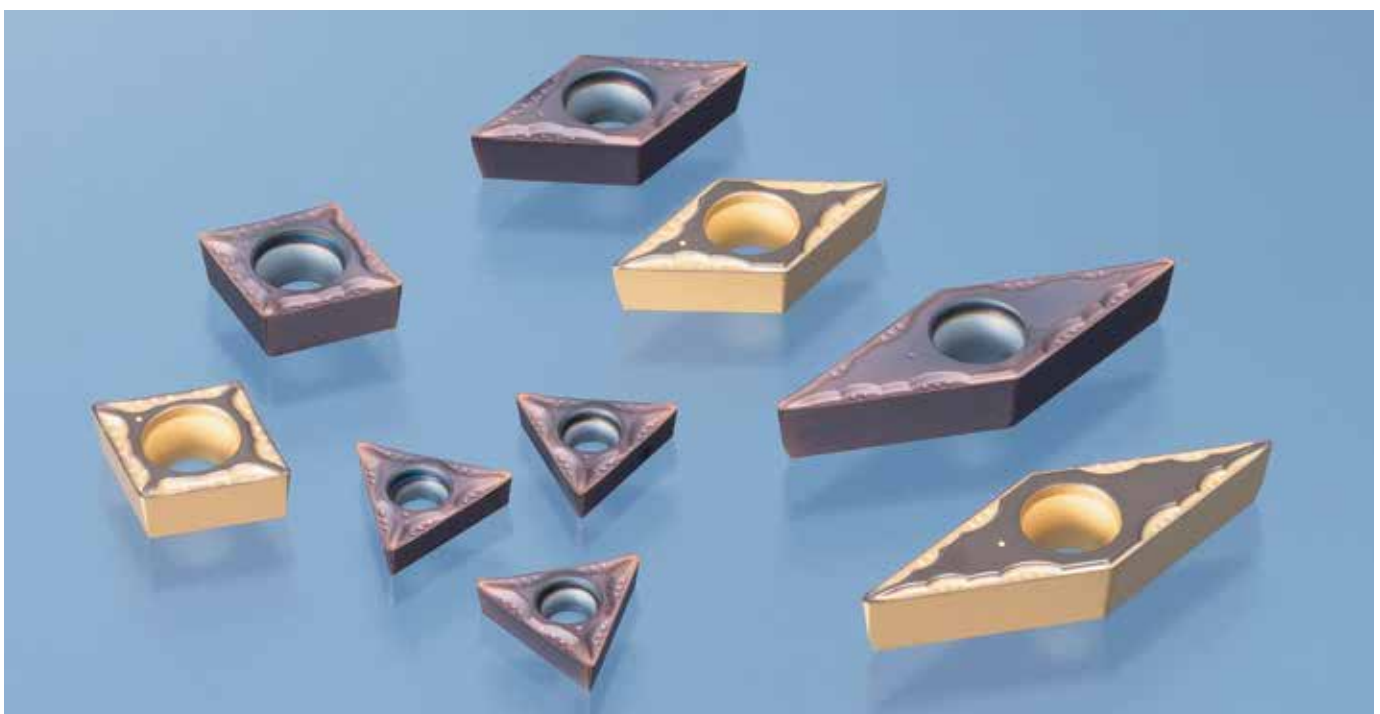

Inserts  
 C  
 D  
 K  
 R  
 S  
 T  
 V  
 W

# Chipbreaker Comparison

## ■ Negative Type

Class	Application	Sumitomo Electric	Mitsubishi	Tungaloy	Kyocera	NTK	Sandvik	Kennametal	SECO Tools	WALTER	ISCAR
<b>P</b>	Fine Finishing	<b>FA</b>	FH,FP	TF	GP		QF	FF	FF1		SF
		<b>FL, FB</b>	FS,FY	NS,ZF	XP,XF,VF	WM			FF2	FP5	
	Finishing	<b>LU, FE</b>	SA,SY	NM	XQ,CQ,PP	TF1	LC	FN		NF3	
		<b>SU</b>	SH	TS,TSF	HQ	UL,WV	XF,MF	CT	MF2		NF
	Wiper Edge	<b>LUW</b>		AFW, FW	WP,WF		WL,WP		W-FF2		
		<b>SEW</b>	SW	ASW, SW	WQ		WF,WMX	FW	W-MF2	NF	WF
	Finishing to Light Cut	<b>SE, SX</b>	LP	AS,ZM	CJ,XS	ZW1,WR	PF,KF	LF, 33		MP3,NS6	F3P, TF
	Medium Cut	<b>GU</b> □UG□	MA,MV	TM,TQ	HS,PS	ZP	XM,QM	P,MG	M3	MU5	GN
		<b>GE, UX</b>	MH,MP	DM,AM	CS,GS,PQ,PT	Z5	PM,SM,KM	MN, MP1		MP5,NM4,NM6	RF, LF
	Wiper Edge	<b>GUW</b>	MW		WE		WM	MW, RW	W-M3	NM	WG
	Roughing	<b>MU, ME</b>	GH, RP	TH, S	HT,GT,PH	G	PR,XMR,KR	RP	M5,MR7	NM7,NM9,RP5	M3P,NR
		<b>MX, MP</b>	HAS,MT	CH				RN	MR6		
Heavy Cut	<b>HG</b>	HL,HZ,HX	THS,TRS	PX,Standard		QR	RM,MR	R4,R5,M6	NR6,NRF	NM	
	<b>HP</b>	HH,HXD,HR	65			HR,SR	RH	R7,MR7	NR8	TNM	
	<b>HU, HW</b>	HV									
	<b>HF</b>	HCS	TUS			MR		RR9	NRR	R3P	
<b>M</b>	Finishing	<b>SU, EF</b>	LM,SH	SS	MQ,GU	ZF1	MF	FP,FS,LF	MF2	NF4,FM5	F3M
	Light to Medium Cut	<b>EX, EG</b>	GM,MS	SF,SA	MS, MU	ZP	23	MS	MF1,M1	MM5	TF,VL
		<b>GU</b>	MM	SM			MM, SMR	MP	MF3,M3	NM4,MS3	M3M,PP
	Roughing	<b>HM</b>	ES,1M,2M	S				UP	MF4, MF5	NR4, RM5	
<b>EM, MU</b>		GH,RM,HM	SH	TK		MR, MRR		M5,MR3	HU5	MR,R3M	
<b>K</b>	Light Cut	<b>UZ</b>	LK,MA,MK	CM,CF	Standard		KF	UN	M5	NM5	GN
	Medium Cut	<b>GZ</b> □UX□	GH,RK,GK	Standard,CH,33	ZS,GC,KG,KH		KM,KR		MR7	RK5, RK7	
<b>N</b>	Finishing	<b>AX</b>		P	AH			MS			
<b>S</b>	Finishing	<b>EF</b>	LS,FJ	HRF			SF, SGF			NFT	F3S
	Medium Cut	<b>EG, EX</b>	MJ,MS	HMM,SA	SQ		SM, SMC		M1	NMT,NMS	VL
	Roughing	<b>MU</b>	GJ,RS		SG,SX		SMR		MR3,MR4	NRT,HU5	
<b>H</b>	Finishing	<b>FV, GH</b>		HP*							
	Light Cut	<b>LV</b>	BF	HF*	HH*,HL*						
	Carburized Layer Removal	<b>SV</b>	BM	HM*	HD*						

\* CBN/PCD tool breaker

## ■ Positive Type

Class	Application	Sumitomo Electric	Mitsubishi	Tungaloy	Kyocera	NTK	Sandvik	Kennametal	SECO Tools	WALTER	ISCAR
<b>P</b>	Finishing	<b>FC</b>	FJ,AM	01, JRP,JTS	CF,GF,VF	AM3,AZ7,FG	UM		GT-F1	FM4	
		<b>FB, LU</b> (FP, FK)	FP,FM,FV,SQ	PSF,PF,23	GP,XP,MP,PP	ZR	PF,UF,MF,KF	11,UF,MF,KF,XF	FF1	PF4	PF
	Wiper Edge	<b>LUW</b>	SW		WP		WF	FW	W-F1	PF	WF
		<b>SDW</b>					WK,WM	MW	W-F2		WG
	Finishing to Light Cut	<b>SI</b>	SMG	JS,CM,PSS	CK,SKS	YL,1L					
	Light to Medium Cut	<b>LB</b>	LP,LM,SV,MQ	PSS,PS,24	XQ	AM2		LF			
<b>SC</b>				GQ,SK,standard	AF1,CL		MP	MF2			
Medium Cut	<b>SU, GU</b>	SV,MQ	PS,TSF,TM	HQ,XQ,GK	AZ8,AM2,AM5	PM,UM,XM		F1	MP4,MM4,FK6	SM, 14	
<b>M</b>	Finishing	<b>FC</b>	FM,FV	PSF,PF,SS,JSS		AZ7	MF,XF	11,UF	FF1	FM4	PF
	Finishing to Light Cut	<b>SI</b>	SMG			YL,1L,CL	UF	LF,FP			
		<b>LB</b>	LM		MQ				F1		
	Light to Medium Cut	<b>SU, GU</b>	SV		HQ	AM5	MM	MP	MF2	MM4,PS5	SM
Medium Cut	<b>MU</b>	NM,MV	PM			UM,MR,XR,UR	MF	F2,M3,M5	PM5,RM4		
<b>K</b>	Finishing	<b>FC</b>		CF			KF,XF	11,UF		FK6	
	Light to Medium Cut	<b>MU</b>	MK			AF1,FM	KM,UM,XR	FP,LF,MF,MP	M5	MK4,RK4	
<b>N</b>	Finishing	<b>AG,AW,AY</b>	AZ	AL,PP	AH,AP		AL	HP	AL	PM2	AS,AF
	Finishing to Light Cut	<b>LD, GD</b>									
<b>S</b>	Finishing	<b>FC, SI</b>	FS	PSS	PP,MQ		WF,MF		MF2,R2,R3		
	Light to Medium Cut	<b>SU, GU</b>	LS,MS	PS,PM	HQ,GK		UM,PM			FV4,MV4	
<b>H</b>	Finishing	<b>FV</b>		HP*							
	Light Cut	<b>LV</b>	BF*								

Inserts

C

D

K

R

S

T

V

W



# Chipbreaker Application

Bumpy Breaker	Standard Breaker	Handed Breaker
Break Master (CBN/PCD)	For Chamfering	

## Negative Type

## Finishing to Medium Cutting

Fine Finishing	<b>N-FB</b> <b>P M K N S H</b> Better chipcontrol under low feed conditions with sharp edge shape. 0,80 $\alpha = 0^\circ$ CNMG1204-0-NFB 	<b>N-FA</b> <b>P M K N S H</b> Profile breaker perfect for fine finishing 1,0 $20^\circ$ $\alpha = 0^\circ$ CNMG1204-0-NFA 
	<b>N-FL</b> <b>P M K N S H</b> Optimal breaker for chip management on iron sheeting 1,0 $10^\circ$ $\alpha = 0^\circ$ CNMG1204-0-NFL 	<b>N-FE</b> <b>P M K N S H</b> Good chipcontrol from low to high feed rate 1,40 0,70 $20^\circ$ $\alpha = 0^\circ$ CNMG1204-0-NFE 

Breaker Code	<b>N-GU</b> <b>P M K N S H</b>	Work Material
Appearance		Characteristics
Relief angle	$\alpha = 0^\circ$	Cross Section
Stock Items		Cross Section Cat. No.

Versatile breaker featuring excellent wear resistance

0,25 2,05  
 $7^\circ$   $25^\circ$   
 CNMG1204-0-NGU

Finishing	<b>N-LU</b> <b>P M K N S H</b> Effective chip management for fluctuating cut depths and copying 1,5 1,0 $10^\circ$ $\alpha = 0^\circ$ CNMG1204-0-NLU 	<b>N-SP</b> <b>P M K N S H</b> Shows excellent cutting performance in finishing to light cutting 1,3 $13^\circ$ $\alpha = 0^\circ$ CNMG1204-0-NSP 	<b>N-SU</b> <b>P M K N S H</b> Effective in high-speed fine finishing 1,3 $13^\circ$ $\alpha = 0^\circ$ CNMG1204-0-NSU 	<b>N-SE</b> <b>P M K N S H</b> Finishing breaker reduces tool wear on rake face. Effective even for high efficiency machining. 0,1 1,5 $17^\circ$ $5^\circ$ $\alpha = 0^\circ$ CNMG1204-0-NSE 	<b>N-EF</b> <b>P M K N S H</b> Chipbreaker for exotic alloy finishing with excellent chip management 1,2 $20^\circ$ $\alpha = 0^\circ$ CNMG1204-0-NEF 
	<b>NLU-W</b> <b>P M K N S H</b> High performance finishing breaker with wiper edge 1,5 1,0 $10^\circ$ $\alpha = 0^\circ$ CNMG1204-0-NLUW Wiper 	<b>NSE-W</b> <b>P M K N S H</b> New high feed finishing breaker with wiper edge 0,13 1,9 $17^\circ$ $5^\circ$ $\alpha = 0^\circ$ CNMG1204-0-NSEW Wiper 	<b>L/R-FX</b> <b>P M K N S H</b> Parallel breaker with superior sharp edge 1,5 $14^\circ$ $\alpha = 0^\circ$ TNGG1604-0-LRFX 	<b>L/R-FY</b> <b>P M K N S H</b> Wide type breaker with sharp edge 2,5 $15^\circ$ $\alpha = 0^\circ$ TNGG1604-0-LRFY 	<b>L/R-FT</b> <b>P M K N S H</b> Arc-shaped ground type finishing breaker 0,15 1,35 $\alpha = 0^\circ$ TNGG1103-0-LRFT 

Light to Medium	<b>N-SJ</b> <b>P M K N S H</b> Standard breaker with excellent cutting edge strength 0,18 1,2 $\alpha = 0^\circ$ SNMG1204-0-NSJ 	<b>L/R-ST</b> <b>P M K N S H</b> Arc-shaped ground type breaker for light cutting 0,15 1,65 $\alpha = 0^\circ$ TNGG1603-0-LRST 	
	<b>N-EX</b> <b>P M K N S H</b> Standard breaker designed especially for use with exotic alloys 2,0 $16^\circ$ $\alpha = 0^\circ$ CNMG1204-0-NEX 	<b>N-UP</b> <b>P M K N S H</b> Double positive edge for optimal stainless steel cutting 2,1 $10^\circ$ $\alpha = 0^\circ$ CNMG1204-0-NUP 	<b>N-SX</b> <b>P M K N S H</b> Perform copying and raise steps 0,2 1,35 $3^\circ$ $15^\circ$ $\alpha = 0^\circ$ CNMG1204-0-NSX 

## Chipbreaker Application Range (Insert IC up to $\varnothing 12,7$ mm)

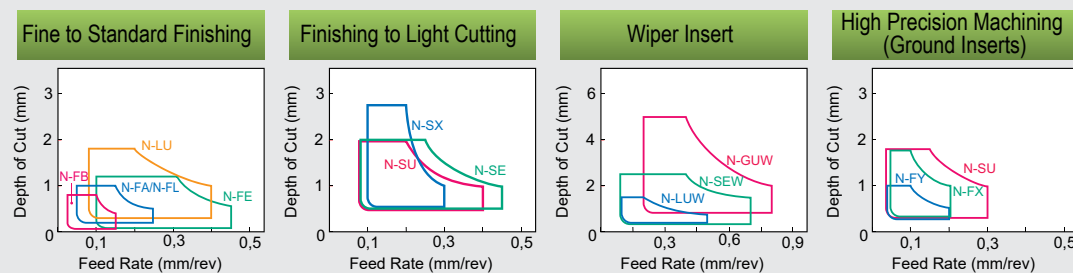

Indicated chipbreaker application ranges and shapes are representative values only. Actual values may change according to the actual catalogue number. For details, refer to stock pages (from Chapter B onward).

Bumpy Breaker	Standard Breaker	Handed Breaker
Break Master (CBN/PCD)	For Chamfering	

# Chipbreaker Application

Negative Type

Medium to Rough Cutting

Medium	<b>N-GU</b> Features low cutting resistance and excellent wear resistance  $\alpha = 0^\circ$ 	<b>N-GE</b> A versatile breaker with excellent rake surface wear in high efficiency cutting  $\alpha = 0^\circ$ 	<b>N-UX</b> Extremely reliable and versatile breaker with strong cutting edge  $\alpha = 0^\circ$ 	<b>N-UG</b> Popular and versatile breaker  $\alpha = 0^\circ$ 
	<b>N-EG</b> General-purpose chipbreaker for exotic alloys with good chip control and wear resistance  $\alpha = 0^\circ$ 	<b>NGU-W</b> Finishing breaker with wiper edge for high efficiency medium finishing  $\alpha = 0^\circ$ 	<b>L/R-UM</b> General-purpose ground type medium cutting breaker  $\alpha = 0^\circ$ 	

Medium to Rough	<b>N-EM</b> Achieves excellent fracture and crater resistance  $\alpha = 0^\circ$ 	<b>N-MU</b> Economical, double-sided breaker with low cutting resistance for high feed cutting  $\alpha = 0^\circ$ 	<b>N-ME</b> Chipbreaker for rough cutting that supports high-feed cutting with reduced rake face wear  $\alpha = 0^\circ$ 	<b>N-MX</b> Strong cutting edge for interrupted cutting  $\alpha = 0^\circ$ 
	<b>N-UZ</b> Standard breaker with stable cutting performance  $\alpha = 0^\circ$ 	<b>N-GZ</b> Extremely reliable standard breaker with strong cutting edge  $\alpha = 0^\circ$ 	<b>L/R-HM</b> Wide, M class, handed breaker with low cutting resistance for medium to rough cutting  $\alpha = 0^\circ$ 	

## Chipbreaker Application Range (Insert IC up to Ø 12,7 mm)

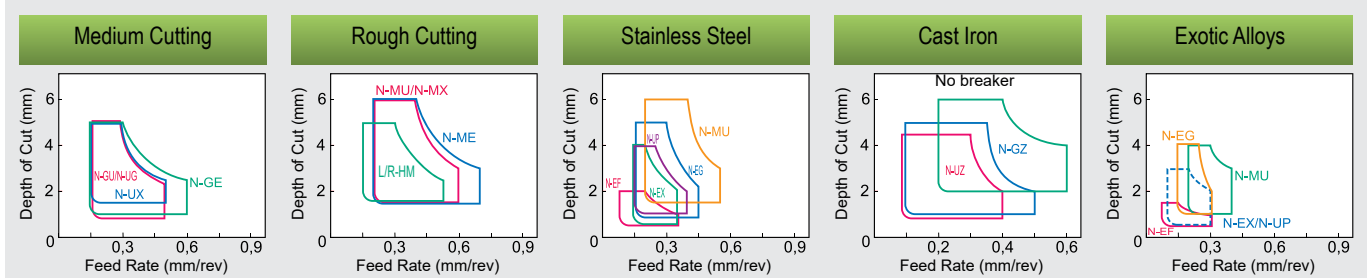

Indicated chipbreaker application ranges and shapes are representative values only. Actual values may change according to the actual catalogue number. For details, refer to stock pages (from Chapter B onward).

Inserts

C

D

K

R



S

T

V



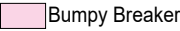
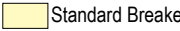
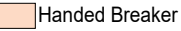





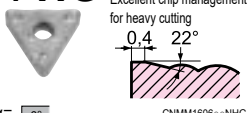

W

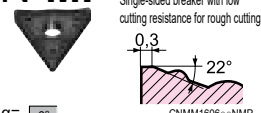
# Chipbreaker Application

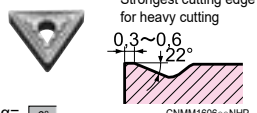
 Bumpy Breaker	 Standard Breaker	 Handed Breaker
 SUMIBORON Break Master	 For Chamfering	

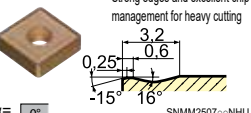
## Negative Type

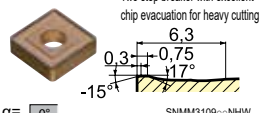
## Rough Cutting

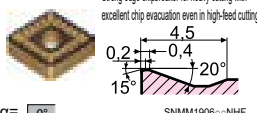
Rough to Heavy	<b>N-HG</b>  <p>Excellent chip management for heavy cutting</p>  <p>CNMM1606--NHG</p>	<b>N-MP</b>  <p>Single-sided breaker with low cutting resistance for rough cutting</p>  <p>CNMM1606--NMP</p>	<b>N-HP</b>  <p>Strongest cutting edge for heavy cutting</p>  <p>CNMM1606--NHP</p>
	<b>N-HU</b>  <p>Strong edges and excellent chip management for heavy cutting</p>  <p>SNMM2507--NHU</p>	<b>N-HW</b>  <p>Two step breaker with excellent chip evacuation for heavy cutting</p>  <p>SNMM3109--NHW</p>	<b>N-HF</b>  <p>Strong edge chipbreaker for heavy cutting with excellent chip evacuation even in high-feed cutting</p>  <p>SNMM1906--NHF</p>

## Negative Type

## For Hardened Steel

**Finishing**

**N-GH** 

For cutting hardened steel with low cutting force and excellent chip control

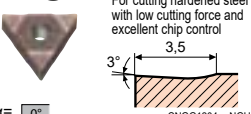



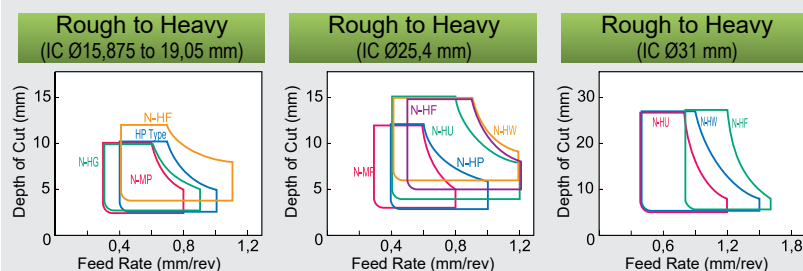

CNMG1204--NGH

## Chipbreaker Application Range











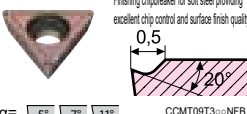

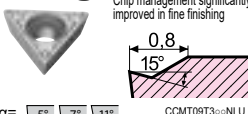

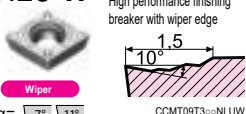

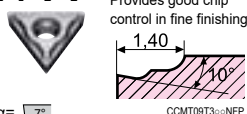

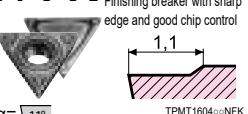

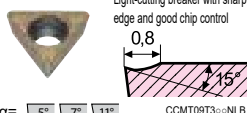

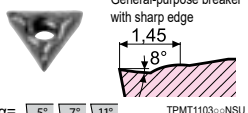
Indicated chipbreaker application ranges and shapes are representative values only. Actual values may change according to the actual catalogue number. For details, refer to stock pages (from Chapter B onward).

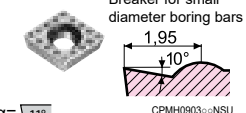

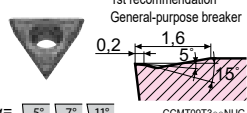

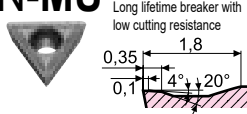

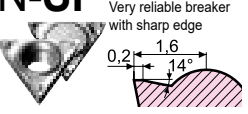



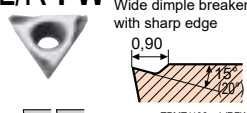

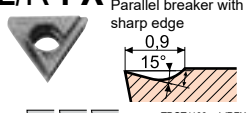

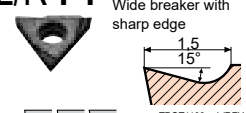
 Bumpy Breaker	 Standard Breaker	 Handed Breaker
 Break Master (CBN/PCD)		

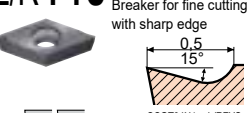
# Chipbreaker Application

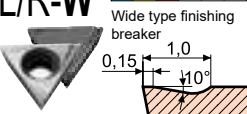
## Positive Type Medium to Rough Cutting

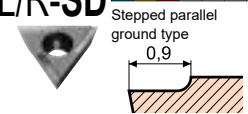
Finish to Light	<b>N-FB</b>  Finishing chipbreaker for soft steel providing excellent chip control and surface finish quality.  $\alpha = 5^\circ, 7^\circ, 11^\circ$ CCMT09T3--NFB	<b>N-LU</b>  Chip management significantly improved in fine finishing.  $\alpha = 5^\circ, 7^\circ, 11^\circ$ CCMT09T3--NLU	<b>NLU-W</b>  High performance finishing breaker with wiper edge.  $\alpha = 7^\circ, 11^\circ$ CCMT09T3--NLUW  Wiper	<b>N-FP</b>  Provides good chip control in fine finishing.  $\alpha = 7^\circ$ CCMT09T3--NFP	<b>N-FK</b>  Finishing breaker with sharp edge and good chip control.  $\alpha = 11^\circ$ TPMT1604--NFK	
	Light to Medium	<b>N-LB</b>  Light-cutting breaker with sharp edge and good chip control.  $\alpha = 5^\circ, 7^\circ, 11^\circ$ CCMT09T3--NLB	<b>N-SU</b>  General-purpose breaker with sharp edge.  $\alpha = 5^\circ, 7^\circ, 11^\circ$ TPMT1103--NSU	<b>N-US</b>  Breaker for small diameter boring bars.  $\alpha = 11^\circ$ CPMH0903--NSU	<b>N-UG</b>  1st recommendation General-purpose breaker.  $\alpha = 5^\circ, 7^\circ, 11^\circ$ CCMT09T3--NUG <b>New</b>	
		<b>N-MU</b>  Long lifetime breaker with low cutting resistance.  $\alpha = 7^\circ, 11^\circ$ TPMT1604--NMU	<b>N-SF</b>  Very reliable breaker with sharp edge.  $\alpha = 11^\circ$ TPMT1604--NSF			

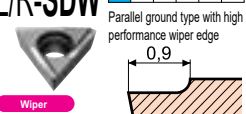
## Positive Type G Class with Ground Chipbreaker

Finish to Light	<b>L/R-FW</b>  Wide dimple breaker with sharp edge.  $\alpha = 5^\circ, 11^\circ$ TPMT1102--LRFW	<b>L/R-FX</b>  Parallel breaker with sharp edge.  $\alpha = 5^\circ, 7^\circ, 11^\circ$ TPGT1103--LRFX	<b>L/R-FY</b>  Wide breaker with sharp edge.  $\alpha = 5^\circ, 7^\circ, 11^\circ$ TPGT1103--LRFY	<b>L/R-FYS</b>  Breaker for fine cutting with sharp edge.  $\alpha = 5^\circ, 7^\circ$ CCGT04X1--LRFYS
	<b>L/R-W</b>  Wide type finishing breaker.  $\alpha = 5^\circ, 11^\circ$ TPGR1103--LRW	<b>L/R-SD</b>  Stepped parallel ground type.  $\alpha = 7^\circ, 11^\circ$ TPGT1103--LRNSD	<b>L/R-SDW</b>  Parallel ground type with high performance wiper edge.  $\alpha = 11^\circ$ TPGX1103--LRSDW  Wiper	

## Chipbreaker Application Range

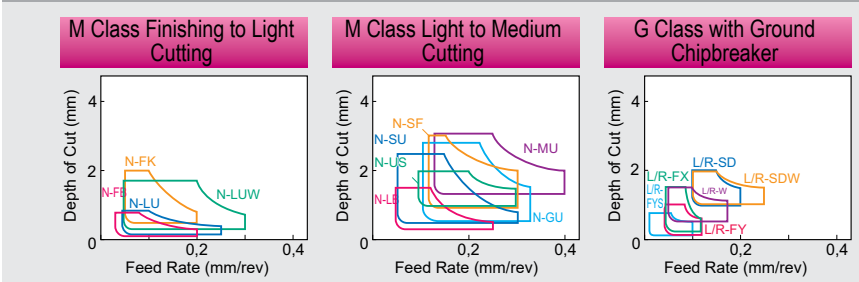

Indicated chipbreaker application ranges and shapes are representative values only. Actual values may change according to the actual catalogue number. For details, refer to stock pages (from Chapter B onward).

- 
- 
- 
- 
- 
- 
- 
- 

# Chipbreaker Application

## Positive Type

## G Class

Finish to Light	<b>N-FC*</b> <p>Peripheral grinding 3D breaker with good chip control and sharp edge</p> <p>CGGT09T3---NFC</p>	<b>N-SI*</b> <p>Shaper-edge breaker for a wide range of cutting applications from finishing to light cutting</p> <p>CGGT09T3---NSI</p>	<b>N-SC*</b> <p>Two step breaker for light cutting</p> <p>TGTT1103---NSC</p>
	<p>* Remarks: N-FC, N-SI and N-SC have minus tolerance indicated by "M" after the nose radius. Example: DCGT 11T302 M NSI AC520U</p>		

## Positive Type

## Round Inserts

Round	<b>N-RX</b> <p>Round, bumpy type insert with excellent chip management</p> <p>RCMX1606MON-RX</p>	<b>N-RP</b> <p>Standard breaker for copying</p> <p>RCMX1606MON-RP</p>
-------	--	---

## Positive Type

## For Al - Alloy Machining

Finishing	<b>N-AG</b> <p>Al breaker for mirror finish and anti-adhesion</p> <p>CGGT09T3---NAG</p>	<b>N-AW</b> <p>Finishing Al breaker with sharp edge</p> <p>VCGT1604---NAW</p>	<b>R/L-AY</b> <p>Al breaker for excellent machined surface quality</p> <p>CGGT09T3---AY</p>
-----------	---	---	---

## Chipbreaker Application Range

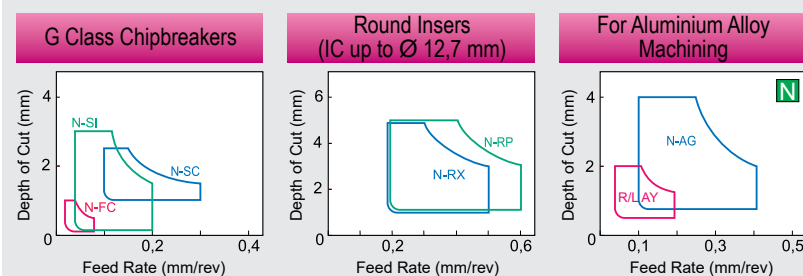

Indicated chipbreaker application ranges and shapes are representative values only. Actual values may change according to the actual catalogue number. For details, refer to stock pages (from Chapter B onward).

# Chipbreaker Application

Bumpy Breaker
  Standard Breaker
  Handed Breaker

## SUMIBORON Insert CBN

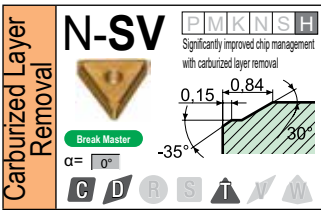
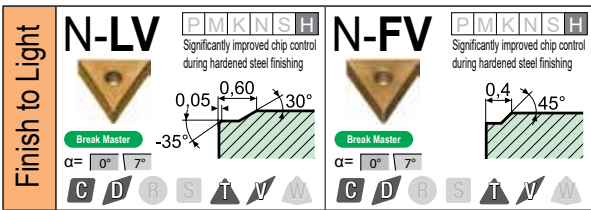

## SUMIDIA Insert PCD

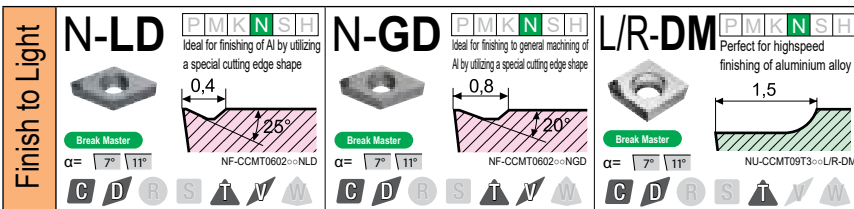

Inserts

- C
- D
- K
- R
- S
- T
- V
- W

## Chipbreaker Application Range

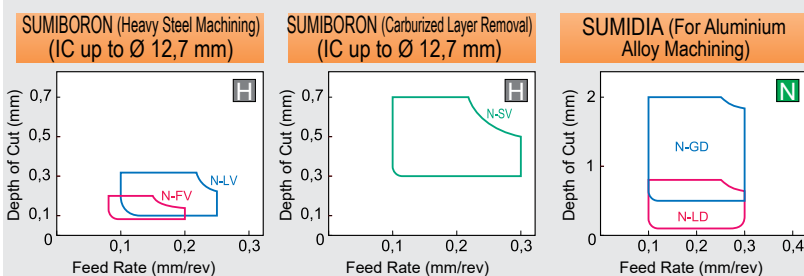

Indicated chipbreaker application ranges and shapes are representative values only. Actual values may change according to the actual catalogue number. For details, refer to stock pages (from Chapter B onward).



# C DIAMOND TYPE

## INSERTS FOR TURNING

### Negative Inserts

80° Diamond Type 0° Relief  
With Insert Hole

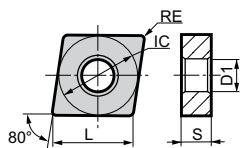

Dimensions (mm)					
CN	L	IC	S	D <sub>1</sub>	
0903..	9,7	9,525	3,18	3,81	
0904..	9,7	9,525	3,18	3,81	
1204..	12,9	12,7	4,76	5,16	



⇨ D12, D18  
D41

⇨ E8

- P Steel
- M Stainless Steel
- K Cast Iron
- N Non-Ferrous Metals
- S Super Alloy
- H Hardened Steel

## CNMG

Carbide										Cermets		Carbide													
Coated										Coated	Uncoated	Uncoated													
P	M	F <sub>M</sub>	K	H	S	P <sub>M</sub>	P	K	S	N															
AC8015P	AC8020P	AC8025P	AC8035P	AC6020M	AC6030M	AC6040M	AC630M	AC4010K	AC4015K	AC420K	AC503U	AC5005S	AC5015S	AC5025S	AC1030U	AC530U	T1500Z	T2500Z	T3000Z	T1000A	T1500A	G10E	EH510	EH520	H1

### ● M-Class, Double Sided Bumpy Chipbreaker

Application	Shape	ISO Cat. No.	RE	AC8015P	AC8020P	AC8025P	AC8035P	AC6020M	AC6030M	AC6040M	AC630M	AC4010K	AC4015K	AC420K	AC503U	AC5005S	AC5015S	AC5025S	AC1030U	AC530U	T1500Z	T2500Z	T3000Z	T1000A	T1500A	G10E	EH510	EH520	H1			
Fine Finishing	 <b>NFB</b> Depth of cut (mm) vs Feed rate (mm/rev) graph.	<b>CNMG 090304 NFB</b> <b>CNMG 090308 NFB</b> <b>CNMG 090404 NFB</b> <b>CNMG 090408 NFB</b>	0,4 0,8 0,4 0,8																													
		<b>CNMG 120402 NFB</b> <b>CNMG 120404 NFB</b> <b>CNMG 120408 NFB</b>	0,2 0,4 0,8																													
Fine Finishing	 <b>NFA</b> Depth of cut (mm) vs Feed rate (mm/rev) graph.	<b>CNMG 120402 NFA</b> <b>CNMG 120404 NFA</b> <b>CNMG 120408 NFA</b>	0,2 0,4 0,8																													
Fine Finishing	 <b>NFL</b> Depth of cut (mm) vs Feed rate (mm/rev) graph.	<b>CNMG 090308 NFL</b> <b>CNMG 120404 NFL</b> <b>CNMG 120408 NFL</b>	0,8 0,4 0,8																													
Fine Finishing	 <b>NFE</b> Depth of cut (mm) vs Feed rate (mm/rev) graph.	<b>CNMG 090304 NFE</b> <b>CNMG 090308 NFE</b> <b>CNMG 090404 NFE</b> <b>CNMG 090408 NFE</b>	0,4 0,8 0,4 0,8																													
		<b>CNMG 120402 NFE</b> <b>CNMG 120404 NFE</b> <b>CNMG 120408 NFE</b> <b>CNMG 120412 NFE</b>	0,2 0,4 0,8 1,2																													
Finishing	 <b>NLU</b> Depth of cut (mm) vs Feed rate (mm/rev) graph.	<b>CNMG 090304 NLU</b> <b>CNMG 090308 NLU</b>	0,4 0,8																													
		<b>CNMG 120402 NLU</b> <b>CNMG 120404 NLU</b> <b>CNMG 120408 NLU</b> <b>CNMG 120412 NLU</b>	0,2 0,4 0,8 1,2																													
		<b>CNMG 120404 NLU-W</b> <b>CNMG 120408 NLU-W</b> <b>CNMG 120412 NLU-W</b>	0,4 0,8 1,2																													
Finishing	 <b>NEF</b> Depth of cut (mm) vs Feed rate (mm/rev) graph.	<b>CNMG 090404 NEF</b> <b>CNMG 090408 NEF</b>	0,4 0,8																													
		<b>CNMG 120404 NEF</b> <b>CNMG 120408 NEF</b> <b>CNMG 120412 NEF</b>	0,4 0,8 1,2																													

● = Euro stock  
 ○ = Stock item in Japan

Neg. Inserts

C

D

K

R

S

T

V

W



# C DIAMOND TYPE

## INSERTS FOR TURNING

### Negative Inserts

80° Diamond Type 0° Relief  
With Insert Hole

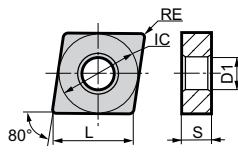

Dimensions (mm)					
CN	L	IC	S	D <sub>1</sub>	
0903..	9,7	9,525	3,18	3,81	
0904..	9,7	9,525	3,18	3,81	
09T3..	9,7	9,525	3,97	3,81	
1204..	12,9	12,7	4,46	5,16	
1606..	16,1	15,875	6,35	6,35	
1906..	19,3	19,05	6,35	7,94	



⇨ D12, D18  
D41

⇨ E8

- P Steel
- M Stainless Steel
- K Cast Iron
- N Non-Ferrous Metals
- S Super Alloy
- H Hardened Steel

## CNMG

Carbide										Cermets		Carbide			
Coated										Coated		Uncoated			
P	M	F <sub>M</sub>	K	H	S	P <sub>M</sub>	P	K	S	N					

### ● M-Class Double Sided Bumpy Chipbreaker

Application	Shape	ISO Cat. No.	RE	AC8015P	AC8020P	AC8025P	AC8035P	AC6020M	AC6030M	AC6040M	AC630M	AC4010K	AC4015K	AC420K	AC503U	AC5005S	AC5015S	AC5025S	AC1030U	AC530U	T1500Z	T2500Z	T3000Z	T1000A	T1500A	G10E	EH510	EH520	H1		
Medium Cut	<p><b>NGE</b></p>	CNMG 120404 NGE	0,4	●	●	●	●																								
		CNMG 120408 NGE	0,8	●	●	●	●																								
		CNMG 120412 NGE	1,2	●	●	●	●																								
		CNMG 120416 NGE	1,6	●	●	●	○																								
		CNMG 160608 NGE	0,8	○	○	○	○																								
		CNMG 160612 NGE	1,2	●	●	●	●																								
Medium Cut	<p><b>NUG</b></p>	CNMG 090304 NUG	0,4																												
		CNMG 090308 NUG	0,8																												
		CNMG 090404 NUG	0,4																												
		CNMG 090408 NUG	0,8																												
		CNMG 09T304 NUG	0,4																												
		CNMG 09T308 NUG	0,8																												
Medium Cut	<p><b>NEG</b></p>	CNMG 090408 NEG	0,8																												
		CNMG 090412 NEG	1,2																												
		CNMG 120404 NEG	0,4	○	●	●	●	●	●	●	●	●																			
		CNMG 120408 NEG	0,8	○	●	●	●	●	●	●	●	●																			
		CNMG 120412 NEG	1,2	○	●	●	●	●	●	●	●	●																			
		CNMG 160608 NEG	0,8	○	●	●	●	○	○																						
Medium Cut	<p><b>NEX</b></p>	CNMG 120404 NEX	0,4																												
		CNMG 120408 NEX	0,8																												
		CNMG 120412 NEX	1,2																												
		CNMG 160612 NEX	1,2																												

● = Euro stock  
○ = Stock item in Japan

**80° Diamond Type** 0° Relief  
With Insert Hole

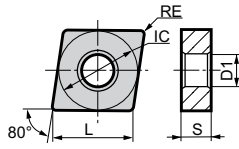

CN	Dimensions (mm)			
	L	IC	S	D <sub>1</sub>
1204..	12,9	12,7	4,46	5,16
1606..	16,1	15,875	6,35	6,35
1906..	19,3	19,05	6,35	7,94
2509..	25,8	25,4	9,52	9,2



⇒ D12, D18  
D41

⇒ E8

- P Steel
- M Stainless Steel
- K Cast Iron
- N Non-Ferrous Metals
- S Super Alloy
- H Hardened Steel



● M-Class Double Sided Bumpy Chipbreaker

Application	Shape	ISO Cat. No.	RE
Medium Cut Depth of cut (mm) Feed rate (mm/rev)	 <b>NUP</b>	<b>CNMG 120404 NUP</b>	0,4
		<b>CNMG 120408 NUP</b>	0,8
		<b>CNMG 120412 NUP</b>	1,2
		<b>CNMG 160612 NUP</b>	1,2
		<b>CNMG 190612 NUP</b>	1,2
Medium Cut Depth of cut (mm) Feed rate (mm/rev)	 <b>NEM</b>	<b>CNMG 120408 NEM</b>	0,8
		<b>CNMG 120412 NEM</b>	1,2
		<b>CNMG 120416 NEM</b>	1,6
		<b>CNMG 160608 NEM</b>	0,8
		<b>CNMG 160612 NEM</b>	1,2
		<b>CNMG 160616 NEM</b>	1,6
		<b>CNMG 190612 NEM</b>	1,2
	<b>CNMG 190616 NEM</b>	1,6	
	<b>CNMG 190624 NEM</b>	2,4	
	<b>CNMG 250924 NEM</b>	2,4	

Carbide											Cermet		Carbide												
Coated											Coated	Uncoated	Uncoated												
P	M	M	P	K	H	S	P	M	P	K	S	N													
AC8015P	AC8020P	AC8025P	AC8035P	AC6020M	AC6030M	AC6040M	AC630M	AC4010K	AC4015K	AC420K	AC503U	AC500S	AC501S	AC5025S	AC1030U	AC530U	T1500Z	T2500Z	T3000Z	T1000A	T1500A	G10E	EH510	EH620	H1

- Neg. Inserts
- C
  - D
  - K
  - R
  - S
  - T
  - V
  - W

● = Euro stock  
○ = Stock item in Japan

# C DIAMOND TYPE

## INSERTS FOR TURNING

### Negative Inserts

**80° Diamond Type** 0° Relief  
With Insert Hole

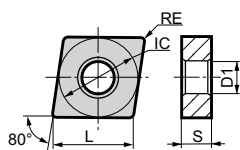

Dimensions (mm)					
CN	L	IC	S	D <sub>1</sub>	
1204..	12,9	12,7	4,76	5,16	
1606..	16,1	15,875	6,35	6,35	
1906..	19,3	19,05	6,35	7,94	
2509..	25,8	25,4	9,52	9,2	



⇨ D12, D18  
D41

⇨ E8

- P Steel
- M Stainless Steel
- K Cast Iron
- N Non-Ferrous Metals
- S Super Alloy
- H Hardened Steel

## CNMG

	Carbide												Cermet		Carbide													
	Coated												Coated	Uncoated	Uncoated													
	P	P	M	M	F <sub>M</sub>	K	H	S	P <sub>M</sub>	P <sub>M</sub>	P	P	K	S	N													
Application	AC8015P	AC8020P	AC8025P	AC8035P	AC6020M	AC6030M	AC6040M	AC630M	AC4010K	AC4015K	AC420K	AC503U	AC5005S	AC5015S	AC5025S	AC1030U	AC530U	T1500Z	T2500Z	T3000Z	T1000A	T1500A	G10E	EH510	EH520	H1		
RE	0,8	1,2	1,6	0,8	1,2	1,6	0,8	1,2	1,6	2,4	2,4	0,8	1,2	1,6	2,4	0,8	1,2	1,6	2,4	0,8	1,2	1,6	2,4	0,8	1,2	1,6	2,4	
Depth of cut (mm)	8	6	4	2	0	0	0	0	0	0	0	0	0	0	0	0	0	0	0	0	0	0	0	0	0	0	0	
Feed rate (mm/rev)	0,2	0,4	0,6	0,2	0,4	0,6	0,2	0,4	0,6	0,2	0,4	0,6	0,2	0,4	0,6	0,2	0,4	0,6	0,2	0,4	0,6	0,2	0,4	0,6	0,2	0,4	0,6	
Shape																												
ISO Cat. No.	<b>CNMG 120408 NMU</b> <b>CNMG 120412 NMU</b> <b>CNMG 120416 NMU</b>  <b>CNMG 160608 NMU</b> <b>CNMG 160612 NMU</b> <b>CNMG 160616 NMU</b>  <b>CNMG 190608 NMU</b> <b>CNMG 190612 NMU</b> <b>CNMG 190616 NMU</b> <b>CNMG 190624 NMU</b>  <b>CNMG 250924 NMU</b>																											
Shape																												
ISO Cat. No.	<b>CNMG 120408 NME</b> <b>CNMG 120412 NME</b> <b>CNMG 120416 NME</b>  <b>CNMG 160608 NME</b> <b>CNMG 160612 NME</b> <b>CNMG 160616 NME</b>  <b>CNMG 190612 NME</b> <b>CNMG 190616 NME</b> <b>CNMG 190624 NME</b>  <b>CNMG 250924 NME</b>																											
Shape																												
ISO Cat. No.	<b>CNMG 090304 NUX</b> <b>CNMG 090308 NUX</b> <b>CNMG 120404 NUX</b> <b>CNMG 120408 NUX</b> <b>CNMG 120412 NUX</b> <b>CNMG 120416 NUX</b>  <b>CNMG 160608 NUX</b> <b>CNMG 160612 NUX</b> <b>CNMG 160616 NUX</b>  <b>CNMG 190608 NUX</b> <b>CNMG 190612 NUX</b> <b>CNMG 190616 NUX</b>																											
Shape																												
ISO Cat. No.	<b>CNMG 120408 NMX</b> <b>CNMG 120412 NMX</b> <b>CNMG 120416 NMX</b>  <b>CNMG 160608 NMX</b> <b>CNMG 160612 NMX</b> <b>CNMG 160616 NMX</b>  <b>CNMG 190612 NMX</b> <b>CNMG 190616 NMX</b>																											

Neg. Inserts

C

D

K

R

S

T

V

W

● = Euro stock  
 ○ = Stock item in Japan

**80° Diamond Type** 0° Relief  
With Insert Hole

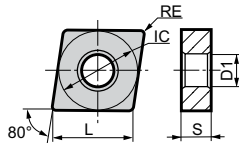

CN	Dimensions (mm)			
	L	IC	S	D <sub>1</sub>
0904..	9,7	9,525	3,18	3,81
1204..	12,9	12,7	4,76	5,16
1606..	16,1	15,875	6,35	6,35
1906..	19,3	19,05	6,35	7,94



⇨ D12, D18  
D41

⇨ E8

- P Steel
- M Stainless Steel
- K Cast Iron
- N Non-Ferrous Metals
- S Super Alloy
- H Hardened Steel

### CNMG

● M-Class Double Sided Bumpy Chipbreaker

Application	Shape	ISO Cat. No.	RE	Carbide													Cermet		Carbide		
				Coated													Coated	Uncoated	Uncoated		
				P	M	P	K	H	S	P	M	P	K	S	N						
Roughing Depth of cut (mm) 6 4 2 0 0,2 0,4 0,6 0,8 Feed rate (mm/rev)		<b>CNMG 090408 NGZ</b> <b>CNMG 090412 NGZ</b>  <b>CNMG 120404 NGZ</b> <b>CNMG 120408 NGZ</b> <b>CNMG 120412 NGZ</b> <b>CNMG 120416 NGZ</b>  <b>CNMG 160608 NGZ</b> <b>CNMG 160612 NGZ</b> <b>CNMG 160616 NGZ</b>  <b>CNMG 190612 NGZ</b> <b>CNMG 190616 NGZ</b>	0,8																		
			1,2																		
			0,4																		
			0,8																		
			1,2																		
			1,6																		
			0,8																		
			1,2																		
			1,6																		
			1,2																		
			1,6																		
			Roughing Depth of cut (mm) 6 4 2 0 0,2 0,4 0,6 0,8 Feed rate (mm/rev)		<b>CNMG 120404 NUZ</b> <b>CNMG 120408 NUZ</b> <b>CNMG 120412 NUZ</b> <b>CNMG 120416 NUZ</b>  <b>CNMG 160608 NUZ</b> <b>CNMG 160612 NUZ</b> <b>CNMG 160616 NUZ</b>  <b>CNMG 190608 NUZ</b> <b>CNMG 190612 NUZ</b> <b>CNMG 190616 NUZ</b>	0,4															
0,8																					
1,2																					
1,6																					
0,8																					
1,2																					
1,6																					
0,8																					
1,2																					
1,6																					
1,2																					
1,6																					

● = Euro stock  
○ = Stock item in Japan

- Neg. Inserts
- C
  - D
  - K
  - R
  - S
  - T
  - V
  - W





**80° Diamond Type** 0° Relief  
With Insert Hole

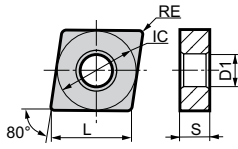

Dimensions (mm)				
CN	L	IC	S	D <sub>1</sub>
1906..	19,3	19,05	6,35	7,94
2509..	25,8	25,4	9,52	9,2



⇨ D12, D18

⇨ E8

- P Steel
- M Stainless Steel
- K Cast Iron
- N Non-Ferrous Metals
- S Super Alloy
- H Hardened Steel

## CNMM

● M-Class One Sided Bumpy Chipbreaker

Application	Shape	ISO Cat. No.	RE
Heavy Roughing		<b>CNMM 190616 NHU</b> <b>CNMM 190624 NHU</b>	1,6 2,4
		<b>CNMM 250924 NHU</b>	2,4
		<b>CNMM 250924 NHW</b>	2,4
Heavy Roughing		<b>CNMM 190616 NHF</b> <b>CNMM 190624 NHF</b>	1,6 2,4
		<b>CNMM 250924 NHF</b>	2,4
		<b>CNMM 250932 NHF</b>	3,2

Carbide													Cermet		Carbide											
Coated													Coated	Uncoated	Uncoated											
P	M	M	P	K	H	S	P	M	P	K	S	N														
AC8015P	AC8020P	AC8025P	AC8035P	AC6020M	AC6030M	AC6040M	AC630M	AC4010K	AC4015K	AC420K	AC503U	AC505S	AC5015S	AC5025S	AC1030U	AC530U	T1500Z	T2500Z	T3000Z	T1000A	T1500A	G10E	EH510	EH620	H1	
●	●	●	●	○	○	○	○	○	○	○	○	○	○	○	○	○	○	○	○	○	○	○	○	○	○	○

● = Euro stock  
 ○ = Stock item in Japan

Neg. Inserts

- 
- 
- 
- 
- 
- 
- 
-

# C DIAMOND TYPE

## INSERTS FOR TURNING

### Negative Inserts

80° Diamond Type 0° Relief  
With Insert Hole

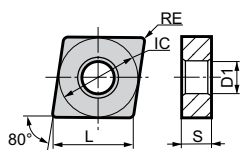

Dimensions (mm)					
CN	L	IC	S	D <sub>1</sub>	
1204..	12,9	12,7	4,76	5,16	
1606..	16,1	15,875	6,35	6,35	
1906..	19,3	19,05	6,35	7,94	



- P Steel
- M Stainless Steel
- K Cast Iron
- N Non-Ferrous Metals
- S Super Alloy
- H Hardened Steel

## CNMA / CNGA / CNMX

Application	Shape	ISO Cat. No.	RE	Carbide										Cermert		Carbide														
				Coated										Coated	Uncoated	Uncoated														
				P	M	F <sub>M</sub>	K	H	S	P <sub>M</sub>	P	K	S	N																
Roughing		CNMA 120404	0,4	AC8015P	AC8020P	AC8025P	AC8035P	AC6020M	AC6030M	AC6040M	AC630M	AC4010K	AC4015K	AC420K	AC503U	AC5005S	AC5015S	AC5025S	AC1030U	AC530U	T1500Z	T2500Z	T3000Z	T1000A	T1500A	G10E	EH510	EH520	H1	
		CNMA 120408	0,8										○	○	●												●			
		CNMA 120412	1,2										○	○	●															
		CNMA 120416	1,6										○	○	●															
		CNMA 160608	0,8										○	○	●															
		CNMA 160612	1,2										○	○	●															
		CNMA 160616	1,6										○	○	●															
		CNMA 190612	1,2										○	○	●															
		CNMA 190616	1,6										○	○	●															
Medium Cut		CNGA 120402	0,2																											
		CNGA 120404	0,4																	○	○									
		CNGA 120408	0,8																	○	○									
Heavy Roughing		CNMX 120408 L	0,8		●	●																								
		CNMX 120408 R	0,8		●	●																								

## CNGG

Application	Shape	ISO Cat. No.	RE	Carbide										Cermert		Carbide															
				Coated										Coated	Uncoated	Uncoated															
				P	M	F <sub>M</sub>	K	H	S	P <sub>M</sub>	P	K	S	N																	
Finishing		CNGG 120402 NSU	0,2	AC8015P	AC8020P	AC8025P	AC8035P	AC6020M	AC6030M	AC6040M	AC630M	AC4010K	AC4015K	AC420K	AC503U	AC5005S	AC5015S	AC5025S	AC1030U	AC530U	T1500Z	T2500Z	T3000Z	T1000A	T1500A	G10E	EH510	EH520	H1		
		CNGG 120404 NSU	0,4																				○	○	○	○	○	○			
		CNGG 120408 NSU	0,8																					○	○	○	○	○			
Finishing		CNGG 120402 NGH	0,2																												
		CNGG 120404 NGH	0,4																												
		CNGG 120408 NGH	0,8																												
Finishing		CNGG 120402 NEF	0,2																												
		CNGG 120404 NEF	0,4																												
		CNGG 120408 NEF	0,8																												
For Aluminum		CNGG 120402 LAX	0,2																												
		CNGG 120404 LAX	0,4																												
		CNGG 120408 LAX	0,8																												
		CNGG 120402 RAX	0,2																												
CNGG 120404 RAX	0,4																														
CNGG 120408 RAX	0,8																														

### ● G-Class Double Sided Bumpy Chipbreaker

Application	Shape	ISO Cat. No.	RE
Finishing	 NSU	CNGG 120402 NSU CNGG 120404 NSU CNGG 120408 NSU	0,2 0,4 0,8
Finishing	 NGH	CNGG 120402 NGH CNGG 120404 NGH CNGG 120408 NGH	0,2 0,4 0,8
Finishing	 NEF	CNGG 120402 NEF CNGG 120404 NEF CNGG 120408 NEF	0,2 0,4 0,8
For Aluminum	 L/RAX	CNGG 120402 LAX CNGG 120404 LAX CNGG 120408 LAX  CNGG 120402 RAX CNGG 120404 RAX CNGG 120408 RAX	0,2 0,4 0,8  0,2 0,4 0,8

● = Euro stock  
○ = Stock item in Japan

**55° Diamond Type** 0° Relief  
With Insert Hole

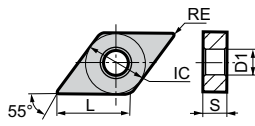

Dimensions (mm)				
DN	L	IC	S	D <sub>1</sub>
1104..	11,6	9,525	4,76	3,81
1504..	15,5	12,7	4,76	5,16
1506..	15,5	12,7	6,35	5,16



⇨ D13, D19  
D41

⇨ E9

- P Steel
- M Stainless Steel
- K Cast Iron
- N Non-Ferrous Metals
- S Super Alloy
- H Hardened Steel

### DNMG

● M-Class Double Sided Bumpy Chipbreaker

Application	Shape	ISO Cat. No.	RE	Carbide										Cermets		Carbide				
				Coated										Coated	Uncoated	Uncoated				
				P	M	M	K	H	S	P	P	K	S	N						
Fine Finishing	 <b>NFB</b>  Depth of cut (mm) vs Feed rate (mm/rev)	<b>DNMG 110404 NFB</b> <b>DNMG 110408 NFB</b>  <b>DNMG 150404 NFB</b> <b>DNMG 150408 NFB</b>  <b>DNMG 150604 NFB</b> <b>DNMG 150608 NFB</b>	0,4	○	○	○	○	○	○	○	○	○	○	○	○	○	○	○		
			0,8	○	○	○	○	○	○	○	○	○	○	○	○	○	○	○	○	
			0,8	○	○	○	○	○	○	○	○	○	○	○	○	○	○	○	○	○
Fine Finishing	 <b>NFA</b>  Depth of cut (mm) vs Feed rate (mm/rev)	<b>DNMG 150404 NFA</b> <b>DNMG 150408 NFA</b>  <b>DNMG 150604 NFA</b> <b>DNMG 150608 NFA</b>	0,4	○	○	○	○	○	○	○	○	○	○	○	○	○	○	○		
			0,8	○	○	○	○	○	○	○	○	○	○	○	○	○	○	○	○	
			0,8	○	○	○	○	○	○	○	○	○	○	○	○	○	○	○	○	○
Fine Finishing	 <b>NFL</b>  Depth of cut (mm) vs Feed rate (mm/rev)	<b>DNMG 150404 NFL</b> <b>DNMG 150408 NFL</b> <b>DNMG 150412 NFL</b>  <b>DNMG 150604 NFL</b> <b>DNMG 150608 NFL</b>	0,4	○	○	○	○	○	○	○	○	○	○	○	○	○	○	○		
			0,8	○	○	○	○	○	○	○	○	○	○	○	○	○	○	○	○	
			1,2	○	○	○	○	○	○	○	○	○	○	○	○	○	○	○	○	○
Fine Finishing	 <b>NFE</b>  Depth of cut (mm) vs Feed rate (mm/rev)	<b>DNMG 110404 NFE</b> <b>DNMG 110408 NFE</b> <b>DNMG 110412 NFE</b>  <b>DNMG 150402 NFE</b> <b>DNMG 150404 NFE</b> <b>DNMG 150408 NFE</b> <b>DNMG 150412 NFE</b>  <b>DNMG 150602 NFE</b> <b>DNMG 150604 NFE</b> <b>DNMG 150608 NFE</b> <b>DNMG 150612 NFE</b>	0,4	○	○	○	○	○	○	○	○	○	○	○	○	○	○	○		
			0,8	○	○	○	○	○	○	○	○	○	○	○	○	○	○	○	○	
			1,2	○	○	○	○	○	○	○	○	○	○	○	○	○	○	○	○	○
Finishing	 <b>NLU</b>  Depth of cut (mm) vs Feed rate (mm/rev)	<b>DNMG 110404 NLU</b> <b>DNMG 110408 NLU</b>  <b>DNMG 150402 NLU</b> <b>DNMG 150404 NLU</b> <b>DNMG 150408 NLU</b> <b>DNMG 150412 NLU</b>  <b>DNMG 150604 NLU</b> <b>DNMG 150608 NLU</b> <b>DNMG 150612 NLU</b>	0,4	●	●	●	○	○	○	○	○	○	○	○	○	○	○	○		
			0,8	●	●	●	○	○	○	○	○	○	○	○	○	○	○	○	○	○
			0,2	○	○	○	○	○	○	○	○	○	○	○	○	○	○	○	○	○

● = Euro stock  
○ = Stock item in Japan

- Neg. Inserts
- C
  - D
  - K
  - R
  - S
  - T
  - V
  - W



**55° Diamond Type** 0° Relief  
With Insert Hole

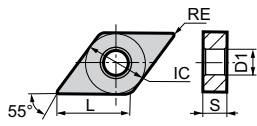

Dimensions (mm)				
DN	L	IC	S	D <sub>1</sub>
1104..	11,6	9,525	4,76	3,81
1504..	15,5	12,7	4,76	5,16
1506..	15,5	12,7	6,35	5,16



⇨ D13, D19  
D41

⇨ E9

- P Steel
- M Stainless Steel
- K Cast Iron
- N Non-Ferrous Metals
- S Super Alloy
- H Hardened Steel

## DNMG

● M-Class Double Sided Bumpy Chipbreaker

Application	Shape	ISO Cat. No.	RE	Carbide										Cermet		Carbide		
				Coated										Coated	Uncoated	Uncoated		
				P	M	M	K	H	S	P	M	P	K	S	N			
Medium Cut	 <b>NGE</b>	<b>DNMG 110408 NGE</b> <b>DNMG 110412 NGE</b>  <b>DNMG 150404 NGE</b> <b>DNMG 150408 NGE</b> <b>DNMG 150412 NGE</b> <b>DNMG 150416 NGE</b>  <b>DNMG 150604 NGE</b> <b>DNMG 150608 NGE</b> <b>DNMG 150612 NGE</b> <b>DNMG 150616 NGE</b>	0,8	○	○	○	○	○	○	○	○	○	○	○	○	○		
			1,2	○	○	○	○	○	○	○	○	○	○	○	○	○	○	
			0,4	○	○	○	○	○	○	○	○	○	○	○	○	○	○	○
			0,8	○	○	○	○	○	○	○	○	○	○	○	○	○	○	○
			1,2	○	○	○	○	○	○	○	○	○	○	○	○	○	○	○
Medium Cut	 <b>NUG</b>	<b>DNMG 110404 NUG</b> <b>DNMG 110408 NUG</b>  <b>DNMG 150404 NUG</b> <b>DNMG 150408 NUG</b> <b>DNMG 150412 NUG</b>  <b>DNMG 150604 NUG</b> <b>DNMG 150608 NUG</b> <b>DNMG 150612 NUG</b> <b>DNMG 150616 NUG</b>	0,4	○	○	○	○	○	○	○	○	○	○	○	○	○		
			0,8	○	○	○	○	○	○	○	○	○	○	○	○	○	○	
			0,4	○	○	○	○	○	○	○	○	○	○	○	○	○	○	○
			0,8	○	○	○	○	○	○	○	○	○	○	○	○	○	○	○
			1,2	○	○	○	○	○	○	○	○	○	○	○	○	○	○	○
Medium Cut	 <b>NEG</b>	<b>DNMG 110408 NEG</b> <b>DNMG 110412 NEG</b>  <b>DNMG 150404 NEG</b> <b>DNMG 150408 NEG</b> <b>DNMG 150412 NEG</b>  <b>DNMG 150604 NEG</b> <b>DNMG 150608 NEG</b> <b>DNMG 150612 NEG</b>	0,8	○	●	●	○	○	○	○	○	○	○	○	○	○		
			1,2	○	●	●	○	○	○	○	○	○	○	○	○	○	○	
			0,4	○	○	○	○	○	○	○	○	○	○	○	○	○	○	○
			0,8	○	○	○	○	○	○	○	○	○	○	○	○	○	○	○
			1,2	○	○	○	○	○	○	○	○	○	○	○	○	○	○	○
Medium Cut	 <b>NEX</b>	<b>DNMG 110404 NEX</b> <b>DNMG 110408 NEX</b>  <b>DNMG 150404 NEX</b> <b>DNMG 150408 NEX</b> <b>DNMG 150412 NEX</b>  <b>DNMG 150604 NEX</b> <b>DNMG 150608 NEX</b> <b>DNMG 150612 NEX</b>	0,4	○	○	○	○	○	○	○	○	○	○	○	○	○		
			0,8	○	○	○	○	○	○	○	○	○	○	○	○	○	○	
			0,4	○	○	○	○	○	○	○	○	○	○	○	○	○	○	○
			0,8	○	○	○	○	○	○	○	○	○	○	○	○	○	○	○
			1,2	○	○	○	○	○	○	○	○	○	○	○	○	○	○	○

● = Euro stock  
○ = Stock item in Japan









# D DIAMOND TYPE

## INSERTS FOR TURNING

### Negative Inserts

55° Diamond Type

0° Relief

With Insert Hole

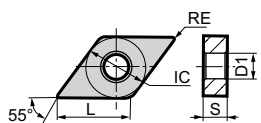

Dimensions (mm)				
DN	L	IC	S	D <sub>1</sub>
1504..	15,5	12,7	4,76	5,16
1506..	15,5	12,7	6,35	5,16



⇒ D13, D19

⇒ E9

- P** Steel
- M** Stainless Steel
- K** Cast Iron
- N** Non-Ferrous Metals
- S** Super Alloy
- H** Hardened Steel

## DNMM

Carbide											Cermets		Carbide												
Coated											Coated	Uncoated	Uncoated												
P	M	M	K	H	S	P	M	P	K	S	N														
AC8015P	AC8020P	AC8025P	AC8035P	AC6020M	AC6030M	AC6040M	AC630M	AC4010K	AC4015K	AC420K	AC503U	AC5005S	AC5015S	AC5025S	AC1030U	AC530U	T1500Z	T2500Z	T3000Z	T1000A	T1500A	G10E	EH510	EH520	H1

### ● M-Class One Sided Bumpy Chipbreaker

Application	Shape	ISO Cat. No.	RE	AC8015P	AC8020P	AC8025P	AC8035P	AC6020M	AC6030M	AC6040M	AC630M	AC4010K	AC4015K	AC420K	AC503U	AC5005S	AC5015S	AC5025S	AC1030U	AC530U	T1500Z	T2500Z	T3000Z	T1000A	T1500A	G10E	EH510	EH520	H1			
Heavy Roughing Depth of cut (mm) Feed rate (mm/rev)	 NMP	DNMM 150404 NMP DNMM 150408 NMP DNMM 150412 NMP DNMM 150416 NMP  DNMM 150604 NMP DNMM 150608 NMP DNMM 150612 NMP DNMM 150616 NMP	0,4	○	○	○	○																									
			0,8	○	○	○	○																									
			1,2	○	○	○	○																									
			1,6	○	○	○	○																									
			0,4	○	●	●	●																									
Heavy Roughing Depth of cut (mm) Feed rate (mm/rev)	 NHG	DNMM 150608 NHG DNMM 150612 NHG DNMM 150616 NHG	0,8	●	●	●	●																									
			1,2	●	●	●	●																									
			1,6	●	●	●	●																									
			0,4	○	○	○	○																									
Heavy Roughing Depth of cut (mm) Feed rate (mm/rev)	 NHP	DNMM 150404 NHP DNMM 150408 NHP DNMM 150412 NHP DNMM 150416 NHP  DNMM 150604 NHP DNMM 150608 NHP DNMM 150612 NHP DNMM 150616 NHP	0,4	○	○	○	○																									
			0,8	○	○	○	○																									
			1,2	○	○	○	○																									
			1,6	○	○	○	○																									
Heavy Roughing Depth of cut (mm) Feed rate (mm/rev)	 NHP	DNMM 150604 NHP DNMM 150608 NHP DNMM 150612 NHP DNMM 150616 NHP	0,4	○	○	○	○																									
			0,8	○	○	○	○																									
			1,2	○	○	○	○																									
			1,6	○	○	○	○																									

● = Euro stock  
○ = Stock item in Japan

55° Diamond Type 0° Relief  
With Insert Hole

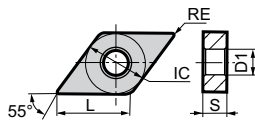

DN	Dimensions (mm)			
	L	IC	S	D <sub>1</sub>
1104..	11,6	9,525	4,76	3,81
1504..	15,5	12,7	4,76	5,16
1506..	15,5	12,7	6,35	5,16

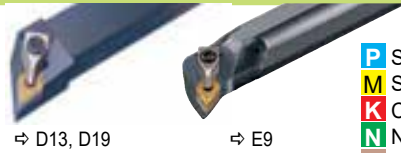

- P Steel
- M Stainless Steel
- K Cast Iron
- N Non-Ferrous Metals
- S Super Alloy
- H Hardened Steel

## DNMA / DNMX

Flat Inserts and One Side Handed Inserts

● M-Class Double Sided Bumpy Chipbreaker

Application	Shape	ISO Cat. No.	RE	Carbide													Cermet		Carbide	
				Coated													Coated	Uncoated	Uncoated	
				P	M	M	K	H	S	P	M	P	K	S	N					
Roughing		DNMA 150404	0,4																	
		DNMA 150408	0,8																	
	DNMA 150412	1,2																		
		DNMA 150608	0,8																	
		DNMA 150612	1,2																	
		DNMX 150608 L	0,8																	
		DNMX 150608 R	0,8																	
Finishing	 Depth of cut (mm) vs Feed rate (mm/rev) graph for "Wiper" W type NSE-W	DNMX 110404 NSE-W	0,4	●	○	○	○													
		DNMX 110408 NSE-W	0,8	○	○	○	○													
		DNMX 110412 NSE-W	1,2	○	○	○	○													
		DNMX 150404 NSE-W	0,4	○	○	○														
		DNMX 150408 NSE-W	0,8	○	○	○														
		DNMX 150412 NSE-W	1,2	○	○	○														
			DNMX 150604 NSE-W	0,4		●	●													
			DNMX 150608 NSE-W	0,8		●	●													
			DNMX 150612 NSE-W	1,2		●														

r	Compensation (mm)	
	X (Diam. change)	Z
0,4	-0,14 (Ø: -0,28)	-0,02
0,8	-0,14 (Ø: -0,28)	-0,02
1,2	-0,1 (Ø: -0,2)	-0,03

(Note) The cutting point position of the SDW type does not follow the ISO standard. Wenn using on a boring holder with a 93° approach angle, there is a need to revise the cutting point position (refer to right table) relative to using standard inserts.

- Neg. Inserts
- C
- D
- K
- R
- S
- T
- V
- W

● = Euro stock  
 ○ = Stock item in Japan

# DIAMOND TYPE

## INSERTS FOR TURNING

### Negative Inserts

55° Diamond Type 0° Relief  
With Insert Hole

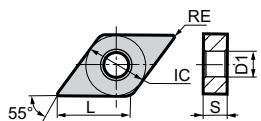

Dimensions (mm)				
DN	L	IC	S	D <sub>1</sub>
1104..	11,6	9,525	4,76	3,81
1504..	15,5	12,7	4,76	5,16



⇒ D13, D19

⇒ E9

- P Steel
- M Stainless Steel
- K Cast Iron
- N Non-Ferrous Metals
- S Super Alloy
- H Hardened Steel

## DNGA

	Carbide										Cermet		Carbide														
	Coated										Coated	Uncoated	Uncoated														
	P	M	M	P	K	H	S	P	M		P	K	S	N													
Application	AC8015P	AC8020P	AC8025P	AC8035P	AC6020M	AC6030M	AC6040M	AC630M	AC4010K	AC4015K	AC420K	AC503U	AC5005S	AC5015S	AC5025S	AC1030U	AC530U	T1500Z	T2500Z	T3000Z	T1000A	T1500A	G10E	EH510	EH520	H1	
Medium Cut																											

### ● G-Class One Sided Bumpy Chipbreaker

Application	Shape	ISO Cat. No.	RE
Medium Cut		DNGA 150402	0,2
		DNGA 150404	0,4
		DNGA 150408	0,8

## DNGG

	Carbide										Cermet		Carbide														
	Coated										Coated	Uncoated	Uncoated														
	P	M	M	P	K	H	S	P	M		P	K	S	N													
Application	AC8015P	AC8020P	AC8025P	AC8035P	AC6020M	AC6030M	AC6040M	AC630M	AC4010K	AC4015K	AC420K	AC503U	AC5005S	AC5015S	AC5025S	AC1030U	AC530U	T1500Z	T2500Z	T3000Z	T1000A	T1500A	G10E	EH510	EH520	H1	
Finishing																											
Finishing																											
Medium Cut																											
Finishing																											
For Aluminum																											

### ● G-Class Double Sided Bumpy Chipbreaker

Application	Shape	ISO Cat. No.	RE
Finishing		DNGG 150404 NEF	0,4
		DNGG 150408 NEF	0,8
Finishing		DNGG 150402 NSU	0,2
		DNGG 150404 NSU	0,4
		DNGG 150408 NSU	0,8
Medium Cut		DNGG 110404 LUM	0,4
		DNGG 110408 LUM	0,8
	DNGG 150404 LUM	0,4	
	DNGG 150408 LUM	0,8	
	DNGG 110404 RUM	0,4	
	DNGG 110408 RUM	0,8	
Finishing		DNGG 150402 NGH	0,2
		DNGG 150404 NGH	0,4
		DNGG 150408 NGH	0,8
For Aluminum		DNGG 150402 LAX	0,2
		DNGG 150404 LAX	0,4
		DNGG 150408 LAX	0,8
For Aluminum		DNGG 150402 RAX	0,2
		DNGG 150404 RAX	0,4
		DNGG 150408 RAX	0,8

● = Euro stock  
 ○ = Stock item in Japan

90° Square Type 0° Relief  
With Insert Hole

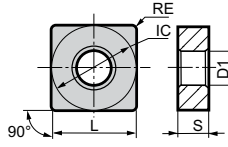

Dimensions (mm)				
SN	L	IC	S	D <sub>1</sub>
1204..	12,7	12,7	4,76	5,16



⇒ D14, D20~21  
D41

⇒ E10

- P Steel
- M Stainless Steel
- K Cast Iron
- N Non-Ferrous Metals
- S Super Alloy
- H Hardened Steel

## SNMG

● M-Class Double Sided Bumpy Chipbreaker

Application	Shape	ISO Cat. No.	RE	Carbide												Cermets		Carbide													
				Coated												Coated	Uncoated	Uncoated													
				P	M	M	K	H	S	P	M	P	K	S	N																
Fine Finishing	 <b>NFB</b> Depth of cut (mm) vs Feed rate (mm/rev) graph.	<b>SNMG 120404 NFB</b> <b>SNMG 120408 NFB</b>	0,4	AC8015P	AC8020P	AC8025P	AC8035P	AC6020M	AC6030M	AC6040M	AC630M	AC4010K	AC4015K	AC420K	AC503U	AC5005S	AC5015S	AC5025S	AC1030U	AC530U	T1500Z	T2500Z	T3000Z	T1000A	T1500A	G10E	EH510	EH620	H1		
			0,8	○	○	○	○	○	○	○	○	○	○	○	○	○	○	○	○	○	○	○	○	○	○	○	○	○	○	○	○
Fine Finishing	 <b>NFL</b> Depth of cut (mm) vs Feed rate (mm/rev) graph.	<b>SNMG 120408 NFL</b>	0,8	○	○	○	○	○	○	○	○	○	○	○	○	○	○	○	○	○	○	○	○	○	○	○	○	○	○	○	
Fine Finishing	 <b>NFE</b> Depth of cut (mm) vs Feed rate (mm/rev) graph.	<b>SNMG 120404 NFE</b> <b>SNMG 120408 NFE</b> <b>SNMG 120412 NFE</b>	0,4 0,8 1,2	○	○	○	○	○	○	○	○	○	○	○	○	○	○	○	○	○	○	○	○	○	○	○	○	○	○	○	○
Finishing	 <b>NLU</b> Depth of cut (mm) vs Feed rate (mm/rev) graph.	<b>SNMG 120408 NLU</b> <b>SNMG 120412 NLU</b>	0,8 1,2	○	○	○	○	○	○	○	○	○	○	○	○	○	○	○	○	○	○	○	○	○	○	○	○	○	○	○	○
Finishing	 <b>NSU</b> Depth of cut (mm) vs Feed rate (mm/rev) graph.	<b>SNMG 120408 NSU</b> <b>SNMG 120412 NSU</b>	0,8 1,2	●	●	●	○	●	●	●	●	○	○	○	○	○	○	○	○	○	○	○	○	○	○	○	○	○	○	○	○
Finishing	 <b>NSE</b> Depth of cut (mm) vs Feed rate (mm/rev) graph.	<b>SNMG 120408 NSE</b> <b>SNMG 120412 NSE</b>	0,8 1,2	○	○	○	○	○	○	○	○	○	○	○	○	○	○	○	○	○	○	○	○	○	○	○	○	○	○	○	○

● = Euro stock  
○ = Stock item in Japan

- Neg. Inserts
- - 
  - 
  - 
  - 
  - 
  - 
  -



# S SQUARE TYPE

## INSERTS FOR TURNING

### Negative Inserts

90° Square Type 0° Relief  
With Insert Hole

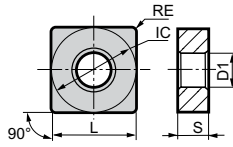

Dimensions (mm)				
SN	L	IC	S	D <sub>1</sub>
0903..	9,525	9,525	3,18	3,81
1204..	12,7	12,7	4,76	5,16
1506..	15,875	15,875	6,35	6,35

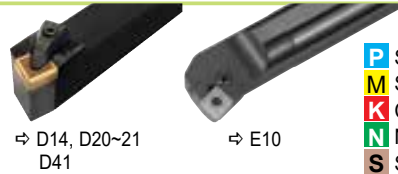

- P Steel
- M Stainless Steel
- K Cast Iron
- N Non-Ferrous Metals
- S Super Alloy
- H Hardened Steel

⇒ D14, D20~21  
D41

⇒ E10

## SNMG

Carbide											Cermets		Carbide		
Coated											Coated		Uncoated		
P	M	F <sub>M</sub>	K	H	S	P <sub>M</sub>	P	K	S	N	P	K	S	N	

### ● M-Class Double Sided Bumpy Chipbreaker

Application	Shape	ISO Cat. No.	RE	AC8015P	AC8020P	AC8025P	AC8035P	AC6020M	AC6030M	AC6040M	AC630M	AC4010K	AC4015K	AC420K	AC503U	AC5005S	AC5015S	AC5025S	AC1030U	AC530U	T1500Z	T2500Z	T3000Z	T1000A	T1500A	G10E	EH510	EH520	H1			
Finishing	 <b>NEF</b>	<b>SNMG 120404 NEF</b> <b>SNMG 120408 NEF</b>	0,4	○	○	○	○	●	●	●							○	○	○													
			0,8	○	●	●	○	○	○										○	○	○											
Finishing	 <b>NSJ</b>	<b>SNMG 090304 NSJ</b> <b>SNMG 120404 NSJ</b>	0,4																													
			0,4																										○			
Finishing	 <b>NSX</b>	<b>SNMG 120404 NSX</b> <b>SNMG 120408 NSX</b> <b>SNMG 120412 NSX</b>	0,4																													
			0,8	○	○	○	○																									
			1,2	○	○	○	○																									
Medium Cut	 <b>NGU</b>	<b>SNMG 090304 NGU</b> <b>SNMG 090308 NGU</b>  <b>SNMG 120404 NGU</b> <b>SNMG 120408 NGU</b> <b>SNMG 120412 NGU</b> <b>SNMG 120416 NGU</b>  <b>SNMG 150608 NGU</b> <b>SNMG 150612 NGU</b> <b>SNMG 150616 NGU</b>	0,4			●																										
			0,8	○	●	●	○																									
			0,4	●	●	●	○																									
			0,8	●	●	●	●																									
			1,2	●	●	●	●																									
Medium Cut	 <b>NGE</b>	<b>SNMG 120408 NGE</b> <b>SNMG 120412 NGE</b> <b>SNMG 120416 NGE</b>  <b>SNMG 150608 NGE</b> <b>SNMG 150612 NGE</b> <b>SNMG 150616 NGE</b>	0,8	○	●	●	○																									
			1,2	○	●	●	●																									
			1,6	○	●	●	○																									
			0,8	○	○	○	○																									

● = Euro stock  
○ = Stock item in Japan

90° Square Type 0° Relief  
With Insert Hole

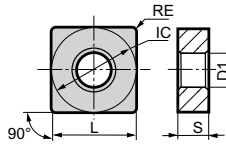

Dimensions (mm)				
SN	L	IC	S	D <sub>1</sub>
0903..	9,525	9,525	3,18	3,81
1204..	12,7	12,7	4,76	5,16
1506..	15,875	15,875	6,35	6,35
1906..	19,05	19,05	6,35	7,94
2509..	25,4	25,4	9,52	9,2



⇒ D14, D20~21  
D41

⇒ E10

- P Steel
- M Stainless Steel
- K Cast Iron
- N Non-Ferrous Metals
- S Super Alloy
- H Hardened Steel

## SNMG

● M-Class Double Sided Bumpy Chipbreaker

Application	Shape	ISO Cat. No.	RE	Carbide										Cermets		Carbide															
				Coated										Coated	Uncoated	Uncoated															
				P	M	M	K	H	S	P	M	P	K	S	N																
				AC8015P	AC8020P	AC8025P	AC8035P	AC6020M	AC6030M	AC6040M	AC630M	AC4010K	AC4015K	AC420K	AC503U	AC5005S	AC5015S	AC5025S	AC1030U	AC530U	T1500Z	T2500Z	T3000Z	T1000A	T1500A	G10E	EH510	EH620	H1		
Medium Cut 		<b>SNMG 090308 NUG</b>	0,8																												
		<b>SNMG 120408 NUG</b>	0,8																												
		<b>SNMG 120412 NUG</b>	1,2																												
		<b>SNMG 120416 NUG</b>	1,6																												
		<b>SNMG 150612 NUG</b>	1,2																												
		<b>SNMG 190612 NUG</b>	1,2																												
		<b>SNMG 190616 NUG</b>	1,6																												
<b>SNMG 250924 NUG</b>	2,4																														
Medium Cut 		<b>SNMG 120404 LUM</b>	0,4																												
		<b>SNMG 120408 LUM</b>	0,8																												
		<b>SNMG 120412 LUM</b>	1,2																												
		<b>SNMG 120404 RUM</b>	0,4																												
<b>SNMG 120408 RUM</b>	0,8																														
Medium Cut 		<b>SNMG 120404 NEG</b>	0,4																												
		<b>SNMG 120408 NEG</b>	0,8																												
		<b>SNMG 120412 NEG</b>	1,2																												
		<b>SNMG 150608 NEG</b>	0,8																												
		<b>SNMG 150612 NEG</b>	1,2																												
		<b>SNMG 150616 NEG</b>	1,6																												
<b>SNMG 190612 NEG</b>	1,2																														
<b>SNMG 190616 NEG</b>	1,6																														
Medium Cut 		<b>SNMG 120404 NEX</b>	0,4																												
		<b>SNMG 120408 NEX</b>	0,8																												
		<b>SNMG 120412 NEX</b>	1,2																												
		<b>SNMG 150612 NEX</b>	1,2																												
		<b>SNMG 190612 NEX</b>	1,2																												
<b>SNMG 190616 NEX</b>	1,6																														
Medium Cut 		<b>SNMG 120404 NUP</b>	0,4																												
		<b>SNMG 120408 NUP</b>	0,8																												
		<b>SNMG 120412 NUP</b>	1,2																												

● = Euro stock  
○ = Stock item in Japan

- Neg. Inserts
- - 
  - 
  - 
  - 
  - 
  - 
  -

# S SQUARE TYPE

## INSERTS FOR TURNING

### Negative Inserts

90° Square Type 0° Relief  
With Insert Hole

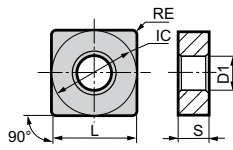

Dimensions (mm)				
SN	L	IC	S	D <sub>1</sub>
0903..	9,525	9,525	3,18	3,81
1204..	12,7	12,7	4,46	5,16
1506..	15,875	15,875	6,35	6,35
1906..	19,05	19,05	6,35	7,94
2509..	25,4	25,4	9,52	9,2



⇨ D14, D20~21  
D41

⇨ E10

- P Steel
- M Stainless Steel
- K Cast Iron
- N Non-Ferrous Metals
- S Super Alloy
- H Hardened Steel

## SNMG

Carbide										Cermets		Carbide													
Coated										Coated	Uncoated	Uncoated													
P	P	M	M	K	H	S	P	P	P	K	S	N	S	S	N										
AC8015P	AC8020P	AC8025P	AC8035P	AC6020M	AC6030M	AC6040M	AC630M	AC4010K	AC4015K	AC420K	AC503U	AC5005S	AC5015S	AC5025S	AC1030U	AC530U	T1500Z	T2500Z	T3000Z	T1000A	T1500A	G10E	EH510	EH520	H1

### ● M-Class Double Sided Bumpy Chipbreaker

Application	Shape	ISO Cat. No.	RE	AC8015P	AC8020P	AC8025P	AC8035P	AC6020M	AC6030M	AC6040M	AC630M	AC4010K	AC4015K	AC420K	AC503U	AC5005S	AC5015S	AC5025S	AC1030U	AC530U	T1500Z	T2500Z	T3000Z	T1000A	T1500A	G10E	EH510	EH520	H1	
Roughing Depth of cut (mm) Feed rate (mm/rev)	 NUX	SNMG 090308 NUX	0,8				○																							
		SNMG 120404 NUX	0,4				○																							
		SNMG 120408 NUX	0,8	●	●	●	●																							
		SNMG 120412 NUX	1,2	●	●	●	●																							
		SNMG 120416 NUX	1,6	○	○	○	○																							
		SNMG 190612 NUX	1,2	○	○	○	○																							
SNMG 190616 NUX	1,6	○	○	○	○																									
Roughing Depth of cut (mm) Feed rate (mm/rev)	 NMU	SNMG 120408 NMU	0,8	●	●	●	●	●	●	●	●						●	●	●											
		SNMG 120412 NMU	1,2	○	○	○	○	○	○	○	○						●	●	●			○								
		SNMG 120416 NMU	1,6	●	○	○	○	●				●																		
		SNMG 150608 NMU	0,8	○	○	○	○										●	●	○	○										
		SNMG 150612 NMU	1,2	○	○	○	○										●	●	○	○										
		SNMG 150616 NMU	1,6	●	○	○	○	●				●					●	○	○	○										
Roughing Depth of cut (mm) Feed rate (mm/rev)	 NEM	SNMG 190612 NMU	1,2	●	●	●	●	●	●	●	●						○	○	○											
		SNMG 190616 NMU	1,6	●	●	●	●	●	●	●	●						○	○	○											
		SNMG 190624 NMU	2,4	○	○	○	○	○	○	○	○	○					○	○	○											
		SNMG 250924 NMU	2,4	○	○	○	○	●										○	○	○										
		SNMG 120408 NEM	0,8	○	●	●	●	○	●	●								○	○	○										
		SNMG 120412 NEM	1,2	○	●	●	●	○	●	●								○	○	○										
Roughing Depth of cut (mm) Feed rate (mm/rev)	 NME	SNMG 150608 NEM	0,8	○	○	○	○	○	○	○	○						○	○	○											
		SNMG 150612 NEM	1,2	○	○	○	○	○	○	○	○						○	○	○											
		SNMG 150616 NEM	1,6	○	○	○	○	○	○	○	○	○						○	○	○										
		SNMG 190612 NEM	1,2	○	○	○	○	○	○	○	○	○						○	○	○										
		SNMG 190616 NEM	1,6	○	○	○	○	○	○	○	○	○						○	○	○										
		SNMG 190624 NEM	2,4	○	○	○	○	○	○	○	○	○						○	○	○										
Roughing Depth of cut (mm) Feed rate (mm/rev)	 NME	SNMG 120408 NME	0,8	○	●	●	●						○	○																
		SNMG 120412 NME	1,2	○	○	○	○							○	○															
		SNMG 120416 NME	1,6	○	○	○	○								○	○														
		SNMG 150608 NME	0,8	○	○	○	○										○	○	○											
		SNMG 150612 NME	1,2	○	○	○	○										○	○	○											
		SNMG 150616 NME	1,6	○	○	○	○										○	○	○											
Roughing Depth of cut (mm) Feed rate (mm/rev)	 NME	SNMG 190612 NME	1,2	○	○	○	○									○	○	○												
		SNMG 190616 NME	1,6	○	○	○	○										○	○	○											
		SNMG 190624 NME	2,4	○	○	○	○										○	○	○											
		SNMG 250924 NME	2,4	○	○	○	○										○	○	○											

● = Euro stock  
○ = Stock item in Japan

90° Square Type 0° Relief  
With Insert Hole

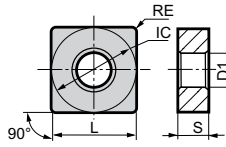

Dimensions (mm)				
SN	L	IC	S	D1
1204..	12,7	12,7	4,46	5,16
1506..	15,875	15,875	6,35	6,35
1906..	19,05	19,05	6,35	7,94



⇒ D14, D20~21  
D41

⇒ E10

- P Steel
- M Stainless Steel
- K Cast Iron
- N Non-Ferrous Metals
- S Super Alloy
- H Hardened Steel

## SNMG

● M-Class Double Sided Bumpy Chipbreaker

Application	Shape	ISO Cat. No.	RE	Carbide													Cermets		Carbide	
				Coated													Coated	Uncoated	Uncoated	
				P	M	M	K	H	S	P	M	P	K	S	N					
Roughing	 <b>L/RHM</b>	<b>SNMG 120408 LHM</b>	0,8	○	○	○	○	○	○	○	○	○	○	○	○	○	○	○	○	
		<b>SNMG 120408 RHM</b>	0,8	○	○	○	○	○	○	○	○	○	○	○	○	○	○	○	○	○
Roughing	 <b>NMX</b>	<b>SNMG 120408 NMX</b>	0,8	○	○	○	○	○	○	○	○	○	○	○	○	○	○	○	○	
		<b>SNMG 120412 NMX</b>	1,2	○	○	○	○	○	○	○	○	○	○	○	○	○	○	○	○	
		<b>SNMG 120416 NMX</b>	1,6	○	○	○	○	○	○	○	○	○	○	○	○	○	○	○	○	○
		<b>SNMG 150612 NMX</b>	1,2	●	●	●	●	●	●	●	●	●	●	●	●	●	●	●	●	●
Roughing	 <b>NGZ</b>	<b>SNMG 150616 NMX</b>	1,6	○	○	○	○	○	○	○	○	○	○	○	○	○	○	○	○	
		<b>SNMG 190612 NMX</b>	1,2	●	●	●	●	●	●	●	●	●	●	●	●	●	●	●	●	●
		<b>SNMG 190616 NMX</b>	1,6	○	○	○	○	○	○	○	○	○	○	○	○	○	○	○	○	○
		<b>SNMG 120408 NGZ</b>	0,8	○	○	○	○	○	○	○	○	○	○	○	○	○	○	○	○	○
Roughing	 <b>NUZ</b>	<b>SNMG 120412 NGZ</b>	1,2	○	○	○	○	○	○	○	○	○	○	○	○	○	○	○	○	
		<b>SNMG 120416 NGZ</b>	1,6	○	○	○	○	○	○	○	○	○	○	○	○	○	○	○	○	○
		<b>SNMG 150612 NGZ</b>	1,2	○	○	○	○	○	○	○	○	○	○	○	○	○	○	○	○	○
		<b>SNMG 150616 NGZ</b>	1,6	○	○	○	○	○	○	○	○	○	○	○	○	○	○	○	○	○
Roughing	 <b>NUZ</b>	<b>SNMG 190612 NGZ</b>	1,2	○	○	○	○	○	○	○	○	○	○	○	○	○	○	○	○	
		<b>SNMG 190616 NGZ</b>	1,6	○	○	○	○	○	○	○	○	○	○	○	○	○	○	○	○	○
		<b>SNMG 120408 NUZ</b>	0,8	○	○	○	○	○	○	○	○	○	○	○	○	○	○	○	○	○
		<b>SNMG 120412 NUZ</b>	1,2	○	○	○	○	○	○	○	○	○	○	○	○	○	○	○	○	○
Roughing	 <b>NUZ</b>	<b>SNMG 120416 NUZ</b>	1,6	○	○	○	○	○	○	○	○	○	○	○	○	○	○	○	○	
		<b>SNMG 150612 NUZ</b>	1,2	○	○	○	○	○	○	○	○	○	○	○	○	○	○	○	○	○
		<b>SNMG 150616 NUZ</b>	1,6	○	○	○	○	○	○	○	○	○	○	○	○	○	○	○	○	○
		<b>SNMG 190612 NUZ</b>	1,2	○	○	○	○	○	○	○	○	○	○	○	○	○	○	○	○	○
Roughing	 <b>NUZ</b>	<b>SNMG 190616 NUZ</b>	1,6	○	○	○	○	○	○	○	○	○	○	○	○	○	○	○	○	
		<b>SNMG 120408 NUZ</b>	0,8	○	○	○	○	○	○	○	○	○	○	○	○	○	○	○	○	○
		<b>SNMG 120412 NUZ</b>	1,2	○	○	○	○	○	○	○	○	○	○	○	○	○	○	○	○	○
		<b>SNMG 120416 NUZ</b>	1,6	○	○	○	○	○	○	○	○	○	○	○	○	○	○	○	○	○

● = Euro stock  
○ = Stock item in Japan

Neg. Inserts



# S SQUARE TYPE

## INSERTS FOR TURNING

### Negative Inserts

90° Square Type 0° Relief  
With Insert Hole

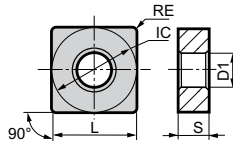

Dimensions (mm)				
SN	L	IC	S	D <sub>1</sub>
1204..	12,7	12,7	4,46	5,16
1506..	15,875	15,875	6,35	6,35
1906..	19,05	19,05	6,35	7,94
2507..	25,4	25,4	7,94	9,2
2509..	25,4	25,4	9,52	9,2
3109..	31,75	31,75	9,52	8,8



⇒ D14, D20~21

⇒ E10

- P Steel
- M Stainless Steel
- K Cast Iron
- N Non-Ferrous Metals
- S Super Alloy
- H Hardened Steel

## SNMM

Carbide										Cermets		Carbide		
Coated										Coated	Uncoated	Uncoated		
P	P	M	M	K	H	S	P	P	K	S	N	K	S	N

### ● M-Class One Sided Bumpy Chipbreaker

Application	Shape	ISO Cat. No.	RE	AC8015P	AC8020P	AC8025P	AC8035P	AC6020M	AC6030M	AC6040M	AC630M	AC4010K	AC4015K	AC420K	AC503U	AC5005S	AC5015S	AC5025S	AC1030U	AC530U	T1500Z	T2500Z	T3000Z	T1000A	T1500A	G10E	EH510	EH520	H1	
Heavy Roughing	 <b>NMP</b>	SNMM 120408 NMP	0,8	○	●	●	●	●	●	●	●	●	●	●	●	○	○	○	○	○	○	○	○	○	○	○	○	○	○	
		SNMM 120412 NMP	1,2	○	○	○	○	○	○	○	○	○	○	○	○	○	○	○	○	○	○	○	○	○	○	○	○	○	○	○
		SNMM 120416 NMP	1,6	○	○	○	○	○	○	○	○	○	○	○	○	○	○	○	○	○	○	○	○	○	○	○	○	○	○	○
		SNMM 120420 NMP	2,0	○	○	○	○	○	○	○	○	○	○	○	○	○	○	○	○	○	○	○	○	○	○	○	○	○	○	○
		SNMM 150612 NMP	1,2	○	●	●	●	○	○	○	○	○	○	○	○	○	○	○	○	○	○	○	○	○	○	○	○	○	○	○
		SNMM 150616 NMP	1,6	○	●	●	●	○	○	○	○	○	○	○	○	○	○	○	○	○	○	○	○	○	○	○	○	○	○	○
		SNMM 190612 NMP	1,2	○	●	●	●	○	○	○	○	○	○	○	○	○	○	○	○	○	○	○	○	○	○	○	○	○	○	○
		SNMM 190616 NMP	1,6	○	●	●	●	○	○	○	○	○	○	○	○	○	○	○	○	○	○	○	○	○	○	○	○	○	○	○
		SNMM 190624 NMP	2,4	○	●	●	●	○	○	○	○	○	○	○	○	○	○	○	○	○	○	○	○	○	○	○	○	○	○	○
		SNMM 250724 NMP	2,4	○	○	○	○	○	○	○	○	○	○	○	○	○	○	○	○	○	○	○	○	○	○	○	○	○	○	○
SNMM 250924 NMP	2,4	○	○	○	○	○	○	○	○	○	○	○	○	○	○	○	○	○	○	○	○	○	○	○	○	○	○	○		
SNMM 310924 NMP	2,4	○	○	○	○	○	○	○	○	○	○	○	○	○	○	○	○	○	○	○	○	○	○	○	○	○	○	○		
Heavy Roughing	 <b>NMH</b>	SNMM 190612 NMH	1,2	●	●	●	●	●	●	○	○	○	○	○	○	○	○	○	○	○	○	○	○	○	○	○	○	○		
		SNMM 190616 NMH	1,6	●	●	●	●	●	●	○	○	○	○	○	○	○	○	○	○	○	○	○	○	○	○	○	○	○	○	
		SNMM 250724 NMH	2,4	○	○	○	○	○	○	○	○	○	○	○	○	○	○	○	○	○	○	○	○	○	○	○	○	○	○	
		SNMM 250924 NMH	2,4	○	○	○	○	○	○	○	○	○	○	○	○	○	○	○	○	○	○	○	○	○	○	○	○	○	○	
Heavy Roughing	 <b>NHG</b>	SNMM 120408 NHG	0,8	●	○	○	○	○	○	○	○	○	○	○	○	○	○	○	○	○	○	○	○	○	○	○	○	○		
		SNMM 120412 NHG	1,2	○	●	●	○	○	○	○	○	○	○	○	○	○	○	○	○	○	○	○	○	○	○	○	○	○	○	
		SNMM 120416 NHG	1,6	○	○	○	○	○	○	○	○	○	○	○	○	○	○	○	○	○	○	○	○	○	○	○	○	○	○	
		SNMM 150612 NHG	1,2	○	●	●	○	○	○	○	○	○	○	○	○	○	○	○	○	○	○	○	○	○	○	○	○	○	○	
		SNMM 150616 NHG	1,6	○	●	●	○	○	○	○	○	○	○	○	○	○	○	○	○	○	○	○	○	○	○	○	○	○	○	
		SNMM 190612 NHG	1,2	○	○	○	○	○	○	○	○	○	○	○	○	○	○	○	○	○	○	○	○	○	○	○	○	○	○	
		SNMM 190616 NHG	1,6	○	●	●	○	○	○	○	○	○	○	○	○	○	○	○	○	○	○	○	○	○	○	○	○	○	○	
SNMM 190624 NHG	2,4	○	○	○	○	○	○	○	○	○	○	○	○	○	○	○	○	○	○	○	○	○	○	○	○	○	○			
SNMM 190616 NHGS	1,6	○	○	○	○	○	○	○	○	○	○	○	○	○	○	○	○	○	○	○	○	○	○	○	○	○	○			
Heavy Roughing	 <b>NHP</b>	SNMM 120408 NHP	0,8	○	○	○	○	○	○	○	○	○	○	○	○	○	○	○	○	○	○	○	○	○	○	○	○	○		
		SNMM 120412 NHP	1,2	○	○	○	○	○	○	○	○	○	○	○	○	○	○	○	○	○	○	○	○	○	○	○	○	○	○	
		SNMM 120416 NHP	1,6	○	○	○	○	○	○	○	○	○	○	○	○	○	○	○	○	○	○	○	○	○	○	○	○	○	○	
		SNMM 150612 NHP	1,2	○	○	○	○	○	○	○	○	○	○	○	○	○	○	○	○	○	○	○	○	○	○	○	○	○	○	
		SNMM 190612 NHP	1,2	○	○	○	○	○	○	○	○	○	○	○	○	○	○	○	○	○	○	○	○	○	○	○	○	○	○	
		SNMM 190616 NHP	1,6	○	○	○	○	○	○	○	○	○	○	○	○	○	○	○	○	○	○	○	○	○	○	○	○	○	○	
		SNMM 190624 NHP	2,4	○	○	○	○	○	○	○	○	○	○	○	○	○	○	○	○	○	○	○	○	○	○	○	○	○	○	
SNMM 250724 NHP	2,4	○	○	○	○	○	○	○	○	○	○	○	○	○	○	○	○	○	○	○	○	○	○	○	○	○	○			
SNMM 250924 NHP	2,4	○	○	○	○	○	○	○	○	○	○	○	○	○	○	○	○	○	○	○	○	○	○	○	○	○	○			
SNMM 310924 NHP	2,4	○	○	○	○	○	○	○	○	○	○	○	○	○	○	○	○	○	○	○	○	○	○	○	○	○	○			

● = Euro stock  
 ○ = Stock item in Japan

90° Square Type 0° Relief  
With Insert Hole

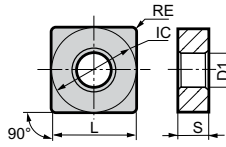

Dimensions (mm)				
SN	L	IC	S	D <sub>1</sub>
1906..	19,05	19,05	6,35	7,94
2507..	25,4	25,4	7,94	9,2
2509..	25,4	25,4	9,52	9,2
3109..	31,75	31,75	9,52	8,8



⇒ D14, D20~21

⇒ E10

- P Steel
- M Stainless Steel
- K Cast Iron
- N Non-Ferrous Metals
- S Super Alloy
- H Hardened Steel

## SNMM

● M-Class One Sided Bumpy Chipbreaker

Application	Shape	ISO Cat. No.	RE	Carbide													Cermet		Carbide												
				Coated													Coated	Uncoated	Uncoated												
				P	M	P/M	K	H	S	P/M	P	K	S	N																	
				AC8015P	AC8020P	AC8025P	AC8035P	AC6020M	AC6030M	AC6040M	AC630M	AC4010K	AC4015K	AC420K	AC503U	AC505S	AC5015S	AC5025S	AC1030U	AC530U	T1500Z	T2500Z	T3000Z	T1000A	T1500A	G10E	EH510	EH620	H1		
<b>Heavy Roughing</b> 	<b>NHU</b> 	<b>SNMM 190616 NHU</b>	1,6																												
		<b>SNMM 250724 NHU</b> <b>SNMM 250924 NHU</b>	2,4 2,4	○ ●	○ ●	○ ●																									
		<b>SNMM 310924 NHU</b>	2,4	○ ○ ○																											
		<b>SNMM 190616 NHW</b>	1,6									●																			
		<b>SNMM 250724 NHW</b>	2,4	○ ● ●								●																			
		<b>SNMM 250924 NHW</b>	2,4	○ ● ●								●																			
		<b>SNMM 310924 NHW</b>	2,4	○ ○ ○								○																			
<b>Heavy Roughing</b> 	<b>NHF</b> 	<b>SNMM 190616 NHF</b> <b>SNMM 190624 NHF</b>	1,6 2,4			○ ○																									
		<b>SNMM 250724 NHF</b> <b>SNMM 250732 NHF</b>	2,4 3,2		○ ○	○ ●					○																				
		<b>SNMM 250924 NHF</b> <b>SNMM 250932 NHF</b>	2,4 3,2		○ ○	○ ●					●																				
		<b>SNMM 310924 NHF</b>	2,4		○ ○																										

● = Euro stock  
 ○ = Stock item in Japan

Neg. Inserts





# S SQUARE TYPE

## INSERTS FOR TURNING

### Negative Inserts

90° Square Type 0° Relief  
With Insert Hole

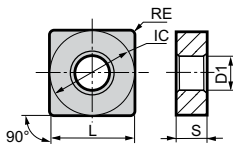

Dimensions (mm)				
SN	L	IC	S	D <sub>1</sub>
0903..	9,525	9,525	3,18	3,81
1204..	12,7	12,7	4,76	5,16
1506..	15,875	15,875	6,35	6,35
1906..	19,05	19,05	6,35	7,94



⇨ D14, D20-21  
D25

⇨ E10

- P Steel
- M Stainless Steel
- K Cast Iron
- N Non-Ferrous Metals
- S Super Alloy
- H Hardened Steel

## SNMA/SNGA

	Carbide										Cermets		Carbide														
	Coated										Coated	Uncoated	Uncoated														
	P	M	M	P	K	H	S	P	M		P	K	S	N													
Roughing	AC8015P	AC8020P	AC8025P	AC8035P	AC6020M	AC6030M	AC6040M	AC630M	AC4010K	AC4015K	AC420K	AC503U	AC5005S	AC5015S	AC5025S	AC1030U	AC530U	T1500Z	T2500Z	T3000Z	T1000A	T1500A	G10E	EH510	EH520	H1	
	○	○	○	○	○	○	○	○	○	○	○	○	○	○	○	○	○	○	○	○	○	○	○	○	○	○	○
	○	○	○	○	○	○	○	○	○	○	○	○	○	○	○	○	○	○	○	○	○	○	○	○	○	○	○
	○	○	○	○	○	○	○	○	○	○	○	○	○	○	○	○	○	○	○	○	○	○	○	○	○	○	○
	○	○	○	○	○	○	○	○	○	○	○	○	○	○	○	○	○	○	○	○	○	○	○	○	○	○	○
	○	○	○	○	○	○	○	○	○	○	○	○	○	○	○	○	○	○	○	○	○	○	○	○	○	○	○
Medium Cut	AC8015P	AC8020P	AC8025P	AC8035P	AC6020M	AC6030M	AC6040M	AC630M	AC4010K	AC4015K	AC420K	AC503U	AC5005S	AC5015S	AC5025S	AC1030U	AC530U	T1500Z	T2500Z	T3000Z	T1000A	T1500A	G10E	EH510	EH520	H1	
	○	○	○	○	○	○	○	○	○	○	○	○	○	○	○	○	○	○	○	○	○	○	○	○	○	○	○
	○	○	○	○	○	○	○	○	○	○	○	○	○	○	○	○	○	○	○	○	○	○	○	○	○	○	○

● G/M-Class No Chipbreaker

Application	Shape	ISO Cat. No.	RE
Roughing		SNMA 120404	0,4
		SNMA 120408	0,8
		SNMA 120412	1,2
		SNMA 120416	1,6
		SNMA 120420	2,0
		SNMA 150612	1,2
SNMA 150616	1,6		
Medium Cut		SNGA 120404	0,4
		SNGA 120408	0,8
		SNGA 120412	1,2

## SNGG

	Carbide										Cermets		Carbide														
	Coated										Coated	Uncoated	Uncoated														
	P	M	M	P	K	H	S	P	M		P	K	S	N													
Light Cutting	AC8015P	AC8020P	AC8025P	AC8035P	AC6020M	AC6030M	AC6040M	AC630M	AC4010K	AC4015K	AC420K	AC503U	AC5005S	AC5015S	AC5025S	AC1030U	AC530U	T1500Z	T2500Z	T3000Z	T1000A	T1500A	G10E	EH510	EH520	H1	
	○	○	○	○	○	○	○	○	○	○	○	○	○	○	○	○	○	○	○	○	○	○	○	○	○	○	○
	○	○	○	○	○	○	○	○	○	○	○	○	○	○	○	○	○	○	○	○	○	○	○	○	○	○	○
	○	○	○	○	○	○	○	○	○	○	○	○	○	○	○	○	○	○	○	○	○	○	○	○	○	○	○
	○	○	○	○	○	○	○	○	○	○	○	○	○	○	○	○	○	○	○	○	○	○	○	○	○	○	○
	○	○	○	○	○	○	○	○	○	○	○	○	○	○	○	○	○	○	○	○	○	○	○	○	○	○	○
Medium Cut	AC8015P	AC8020P	AC8025P	AC8035P	AC6020M	AC6030M	AC6040M	AC630M	AC4010K	AC4015K	AC420K	AC503U	AC5005S	AC5015S	AC5025S	AC1030U	AC530U	T1500Z	T2500Z	T3000Z	T1000A	T1500A	G10E	EH510	EH520	H1	
	○	○	○	○	○	○	○	○	○	○	○	○	○	○	○	○	○	○	○	○	○	○	○	○	○	○	○
	○	○	○	○	○	○	○	○	○	○	○	○	○	○	○	○	○	○	○	○	○	○	○	○	○	○	○
For Aluminum	AC8015P	AC8020P	AC8025P	AC8035P	AC6020M	AC6030M	AC6040M	AC630M	AC4010K	AC4015K	AC420K	AC503U	AC5005S	AC5015S	AC5025S	AC1030U	AC530U	T1500Z	T2500Z	T3000Z	T1000A	T1500A	G10E	EH510	EH520	H1	
	○	○	○	○	○	○	○	○	○	○	○	○	○	○	○	○	○	○	○	○	○	○	○	○	○	○	○
	○	○	○	○	○	○	○	○	○	○	○	○	○	○	○	○	○	○	○	○	○	○	○	○	○	○	○

● G-Class Double Sided Bumpy Chipbreaker

Application	Shape	ISO Cat. No.	RE
Light Cutting		SNGG 090304 LST	0,4
		SNGG 090308 LST	0,8
Light Cutting		SNGG 090304 RST	0,4
		SNGG 090308 RST	0,8
Medium Cut		SNGG 120404 LUM	0,4
		SNGG 120408 LUM	0,8
Medium Cut		SNGG 120404 RUM	0,4
		SNGG 120408 RUM	0,8
For Aluminum		SNGG 120404 LAX	0,4
		SNGG 120404 RAX	0,4
		SNGG 120408 RAX	0,8

● = Euro stock  
○ = Stock item in Japan

90° Square Type 0° Relief  
Without Insert Hole

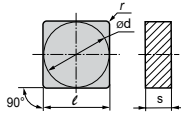

Dimensions (mm)				
SN	L	IC	S	D <sub>1</sub>
1204..	12,7	12,7	4,76	5,16

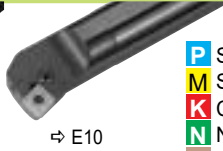

- P Steel
- M Stainless Steel
- K Cast Iron
- N Non-Ferrous Metals
- S Super Alloy
- H Hardened Steel

**SN\_N** ○○○○○○

● G/M-Class No Chipbreaker

Application	Shape	ISO Cat. No.	RE	Carbide										Cermet		Carbide														
				Coated										Coated	Uncoated	Uncoated														
				P	M	K	H	S	P	M		P	K	S	N															
Medium Cut		SNGN 120408	0,8	AC8015P	AC8020P	AC8025P	AC8035P	AC6020M	AC6030M	AC6040M	AC630M	AC4010K	AC4015K	AC420K	AC503U	AC505S	AC5015S	AC5025S	AC1030U	AC530U	T1500Z	T2500Z	T3000Z	T1000A	T1500A	G10E	EH510	EH620	H1	
				○	○	○	○	○	○	○	○	○	○	○	○	○	○	○	○	○	○	○	○	○	○	○	○	○	○	○
Medium Cut		SNMN 120408 SNMN 120412 SNMN 120416	0,8 1,2 1,6									○	○	○		○	○	○												

● = Euro stock  
○ = Stock item in Japan

Neg. Inserts





**60° Triangle Type** 0° Relief  
With Insert Hole

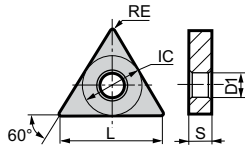

Dimensions (mm)					
TN	L	IC	S	D <sub>1</sub>	
1603..	16,5	9,525	3,18	3,81	
1604..	16,5	9,525	4,76	3,81	
2204..	22,0	12,7	4,76	5,16	



⇒ D15, D22~23  
D42

⇒ E12

- P Steel
- M Stainless Steel
- K Cast Iron
- N Non-Ferrous Metals
- S Super Alloy
- H Hardened Steel

## TNMG

● M-Class Double Sided Bumpy Chipbreaker

Application	Shape	ISO Cat. No.	RE	Carbide													Cermets		Carbide		
				Coated													Coated	Uncoated	Uncoated		
				P	M	M	K	H	S	P	M	P	K	S	N						
Finishing	 <b>NSE</b>	<b>TNMG 160404 NSE</b> <b>TNMG 160408 NSE</b> <b>TNMG 160412 NSE</b>  <b>TNMG 220404 NSE</b> <b>TNMG 220408 NSE</b> <b>TNMG 220412 NSE</b>	0,4	●	●	●	○														
			0,8	●	●	●	○														
			1,2	●	●	●	○														
			0,4	●	●	●	○														
			0,8	●	○	○	○														
			1,2	○	○	○	○														
Finishing	 <b>NSX</b>	<b>TNMG 160304 NSX</b> <b>TNMG 160308 NSX</b>  <b>TNMG 160404 NSX</b> <b>TNMG 160408 NSX</b>  <b>TNMG 220404 NSX</b> <b>TNMG 220408 NSX</b> <b>TNMG 220412 NSX</b>	0,4	○	○																
			0,8	○	○	○															
			0,4	●	○	○	○														
			0,8	○	●	●	○														
			0,4	○	○	○	○														
			0,8	○	○	○	○														
Medium Cut	 <b>NGU</b>	<b>TNMG 160404 NGU</b> <b>TNMG 160408 NGU</b> <b>TNMG 160412 NGU</b> <b>TNMG 160416 NGU</b>  <b>TNMG 220404 NGU</b> <b>TNMG 220408 NGU</b> <b>TNMG 220412 NGU</b>	0,4	●	●	●	●	●	○	○											
			0,8	●	●	●	●	●	○	○											
			1,2	●	●	●	●	●	○	○											
			1,6	○	●	●	●	●	○	○											
			0,4	●	○	○															
			0,8	●	○	○															
Medium Cut	 <b>NGE</b>	<b>TNMG 160404 NGE</b> <b>TNMG 160408 NGE</b> <b>TNMG 160412 NGE</b>  <b>TNMG 220408 NGE</b> <b>TNMG 220412 NGE</b>	0,4	●	●	○															
			0,8	●	●	○															
			1,2	●	●	●															
			0,8	○	●	●															
			1,2	○	○	●															

● = Euro stock  
○ = Stock item in Japan

- Neg. Inserts
- C
  - D
  - K
  - R
  - S
  - T
  - V
  - W

# T TRIANGLE TYPE

## INSERTS FOR TURNING

### Negative Inserts

60° Triangle Type 0° Relief  
With Insert Hole

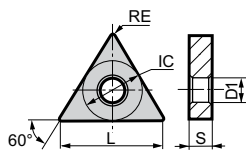

Dimensions (mm)				
TN	L	IC	S	D <sub>1</sub>
1604..	16,5	9,525	4,76	3,81
2204..	22,0	12,7	4,76	5,16



⇒ D15, D22~23  
D42

⇒ E12

- P Steel
- M Stainless Steel
- K Cast Iron
- N Non-Ferrous Metals
- S Super Alloy
- H Hardened Steel

## TNMG

	Carbide										Cermets		Carbide												
	Coated										Coated	Uncoated	Uncoated												
	P	M	M	K	H	S	P	M	P	K	S	N													
AC8015P	AC8020P	AC8025P	AC8035P	AC6020M	AC6030M	AC6040M	AC630M	AC4010K	AC4015K	AC420K	AC503U	AC5005S	AC5015S	AC5025S	AC1030U	AC530U	T1500Z	T2500Z	T3000Z	T1000A	T1500A	G10E	EH510	EH520	H1

### ● M-Class Double Sided Bumpy Chipbreaker

Application	Shape	ISO Cat. No.	RE	AC8015P	AC8020P	AC8025P	AC8035P	AC6020M	AC6030M	AC6040M	AC630M	AC4010K	AC4015K	AC420K	AC503U	AC5005S	AC5015S	AC5025S	AC1030U	AC530U	T1500Z	T2500Z	T3000Z	T1000A	T1500A	G10E	EH510	EH520	H1	
Medium Cut Depth of cut (mm) Feed rate (mm/rev)	 NUG	TNMG 160404 NUG TNMG 160408 NUG TNMG 160412 NUG TNMG 160416 NUG	0,4 0,8 1,2 1,6	● ● ○ ○	○ ○ ○ ○	○ ○ ○ ○	○ ○ ○ ○	○ ○ ○ ○	○ ○ ○ ○	○ ○ ○ ○	○ ○ ○ ○	○ ○ ○ ○	○ ○ ○ ○	○ ○ ○ ○	○ ○ ○ ○	○ ○ ○ ○	○ ○ ○ ○	○ ○ ○ ○	○ ○ ○ ○	○ ○ ○ ○	○ ○ ○ ○	○ ○ ○ ○	○ ○ ○ ○	○ ○ ○ ○	○ ○ ○ ○	○ ○ ○ ○	○ ○ ○ ○	○ ○ ○ ○		
		TNMG 220408 NUG TNMG 220412 NUG	0,8 1,2	○ ○	○ ○	○ ○	○ ○	○ ○	○ ○	○ ○	○ ○	○ ○	○ ○	○ ○	○ ○	○ ○	○ ○	○ ○	○ ○	○ ○	○ ○	○ ○	○ ○	○ ○	○ ○	○ ○	○ ○	○ ○	○ ○	○ ○
Medium Cut Depth of cut (mm) Feed rate (mm/rev)	 L/RUM	TNMG 160404 LUM TNMG 160408 LUM	0,4 0,8	○ ○	○ ○	○ ○	○ ○	○ ○	○ ○	○ ○	○ ○	○ ○	○ ○	○ ○	○ ○	○ ○	○ ○	○ ○	○ ○	○ ○	○ ○	○ ○	○ ○	○ ○	○ ○	○ ○	○ ○	○ ○	○ ○	○ ○
		TNMG 220404 LUM TNMG 220408 LUM	0,4 0,8	○ ○	○ ○	○ ○	○ ○	○ ○	○ ○	○ ○	○ ○	○ ○	○ ○	○ ○	○ ○	○ ○	○ ○	○ ○	○ ○	○ ○	○ ○	○ ○	○ ○	○ ○	○ ○	○ ○	○ ○	○ ○	○ ○	○ ○
Medium Cut Depth of cut (mm) Feed rate (mm/rev)	 NEG	TNMG 160404 RUM TNMG 160408 RUM	0,4 0,8	○ ○	○ ○	○ ○	○ ○	○ ○	○ ○	○ ○	○ ○	○ ○	○ ○	○ ○	○ ○	○ ○	○ ○	○ ○	○ ○	○ ○	○ ○	○ ○	○ ○	○ ○	○ ○	○ ○	○ ○	○ ○	○ ○	○ ○
		TNMG 220404 RUM TNMG 220408 RUM	0,4 0,8	○ ○	○ ○	○ ○	○ ○	○ ○	○ ○	○ ○	○ ○	○ ○	○ ○	○ ○	○ ○	○ ○	○ ○	○ ○	○ ○	○ ○	○ ○	○ ○	○ ○	○ ○	○ ○	○ ○	○ ○	○ ○	○ ○	○ ○
Medium Cut Depth of cut (mm) Feed rate (mm/rev)	 NEX	TNMG 160404 NEG TNMG 160408 NEG TNMG 160412 NEG	0,4 0,8 1,2	○ ○ ○	○ ○ ○	○ ○ ○	○ ○ ○	○ ○ ○	○ ○ ○	○ ○ ○	○ ○ ○	○ ○ ○	○ ○ ○	○ ○ ○	○ ○ ○	○ ○ ○	○ ○ ○	○ ○ ○	○ ○ ○	○ ○ ○	○ ○ ○	○ ○ ○	○ ○ ○	○ ○ ○	○ ○ ○	○ ○ ○	○ ○ ○	○ ○ ○	○ ○ ○	
		TNMG 160404 NEX TNMG 160408 NEX TNMG 160412 NEX	0,4 0,8 1,2	○ ○ ○	○ ○ ○	○ ○ ○	○ ○ ○	○ ○ ○	○ ○ ○	○ ○ ○	○ ○ ○	○ ○ ○	○ ○ ○	○ ○ ○	○ ○ ○	○ ○ ○	○ ○ ○	○ ○ ○	○ ○ ○	○ ○ ○	○ ○ ○	○ ○ ○	○ ○ ○	○ ○ ○	○ ○ ○	○ ○ ○	○ ○ ○	○ ○ ○	○ ○ ○	○ ○ ○
Medium Cut Depth of cut (mm) Feed rate (mm/rev)	 NUP	TNMG 160404 NUG TNMG 160408 NUG TNMG 160412 NUG	0,4 0,8 1,2	○ ○ ○	○ ○ ○	○ ○ ○	○ ○ ○	○ ○ ○	○ ○ ○	○ ○ ○	○ ○ ○	○ ○ ○	○ ○ ○	○ ○ ○	○ ○ ○	○ ○ ○	○ ○ ○	○ ○ ○	○ ○ ○	○ ○ ○	○ ○ ○	○ ○ ○	○ ○ ○	○ ○ ○	○ ○ ○	○ ○ ○	○ ○ ○	○ ○ ○	○ ○ ○	
		TNMG 220408 NUP	0,8	○	○	○	○	○	○	○	○	○	○	○	○	○	○	○	○	○	○	○	○	○	○	○	○	○	○	○

● = Euro stock  
○ = Stock item in Japan

**60° Triangle Type** 0° Relief  
With Insert Hole

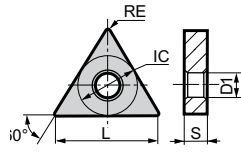

Dimensions (mm)					
TN	L	IC	S	D <sub>1</sub>	
1604..	16,5	9,525	4,76	3,81	
2204..	22,0	12,7	4,76	5,16	
2706..	27,5	15,875	6,35	6,35	
3309..	33,0	19,05	9,52	7,93	



⇒ D15, D22~23  
D42

⇒ E12

- P Steel
- M Stainless Steel
- K Cast Iron
- N Non-Ferrous Metals
- S Super Alloy
- H Hardened Steel

## TNMG

● M-Class Double Sided Bumpy Chipbreaker

Application	Shape	ISO Cat. No.	RE	Carbide												Cermets		Carbide			
				Coated												Coated	Uncoated	Uncoated			
				P	M	M	K	H	S	P	M	P	K	S	N						
Roughing	 <b>NUX</b>	<b>TNMG 160404 NUX</b> <b>TNMG 160408 NUX</b> <b>TNMG 160412 NUX</b>  <b>TNMG 220408 NUX</b> <b>TNMG 220412 NUX</b>	0,4	○	●	●	○														
			0,8	●	●	●	○														
			1,2	●	●	●	○														
			0,8	○	○	○	○														
			1,2	○	○	○	○														
Roughing	 <b>NMU</b>	<b>TNMG 160408 NMU</b> <b>TNMG 160412 NMU</b>  <b>TNMG 220408 NMU</b> <b>TNMG 220412 NMU</b> <b>TNMG 220416 NMU</b>  <b>TNMG 270612 NMU</b> <b>TNMG 270616 NMU</b>	0,8	●	●	●	○														
			1,2	●	●	●	○														
			0,8	●	●	●	○														
			1,2	●	●	●	○														
			1,6	●	●	●	○														
Roughing	 <b>NEM</b>	<b>TNMG 160408 NEM</b> <b>TNMG 160412 NEM</b>  <b>TNMG 330924 NEM</b>	0,8	○	●	○	○														
			1,2	○	○	○	○														
			2,4																		
			0,8	○	○	○	○														
			1,2	○	○	○	○														
Roughing	 <b>NME</b>	<b>TNMG 160408 NME</b> <b>TNMG 160412 NME</b>  <b>TNMG 220408 NME</b> <b>TNMG 220412 NME</b> <b>TNMG 220416 NME</b>	0,8	○	●	○	○														
			1,2	●	●	○	○														
			0,8	○	○	○	○														
			1,2	○	○	○	○														
			1,6	○	○	○	○														
Roughing	 <b>NMX</b>	<b>TNMG 160408 NMX</b> <b>TNMG 160412 NMX</b>  <b>TNMG 220408 NMX</b> <b>TNMG 220412 NMX</b>	0,8	○	○	○	○														
			1,2	○	○	○	○														
			0,8	○	○	○	○														
			1,2	○	○	○	○														

● = Euro stock  
○ = Stock item in Japan

- Neg. Inserts
- C
  - D
  - K
  - R
  - S
  - T
  - V
  - W



# T TRIANGLE TYPE

## INSERTS FOR TURNING

### Negative Inserts

60° Triangle Type 0° Relief  
With Insert Hole

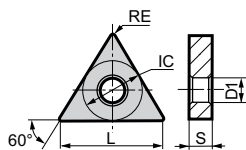

Dimensions (mm)				
TN	L	IC	S	D <sub>1</sub>
1604..	16,5	9,525	4,76	3,81
2204..	22,0	12,7	4,76	5,16
2706..	27,5	15,875	6,35	6,35



⇒ D15, D22~23  
D42

⇒ E12

- P Steel
- M Stainless Steel
- K Cast Iron
- N Non-Ferrous Metals
- S Super Alloy
- H Hardened Steel

# TNMG

Carbide										Cermert		Carbide													
Coated										Coated	Uncoated	Uncoated													
P	M	F <sub>M</sub>	K	H	S	P <sub>M</sub>	P	K	S	N															
AC8015P	AC8020P	AC8025P	AC8035P	AC6020M	AC6030M	AC6040M	AC630M	AC4010K	AC4015K	AC420K	AC503U	AC5005S	AC5015S	AC5025S	AC1030U	AC530U	T1500Z	T2500Z	T3000Z	T1000A	T1500A	G10E	EH510	EH520	H1

### ● M-Class Double Sided Bumpy Chipbreaker

Application	Shape	ISO Cat. No.	RE	AC8015P	AC8020P	AC8025P	AC8035P	AC6020M	AC6030M	AC6040M	AC630M	AC4010K	AC4015K	AC420K	AC503U	AC5005S	AC5015S	AC5025S	AC1030U	AC530U	T1500Z	T2500Z	T3000Z	T1000A	T1500A	G10E	EH510	EH520	H1	
Roughing Depth of cut (mm) Feed rate (mm/rev)	 <b>NGZ</b>	TNMG 160404 NGZ TNMG 160408 NGZ TNMG 160412 NGZ	0,4 0,8 1,2									○	○	○																
		TNMG 220408 NGZ TNMG 220412 NGZ TNMG 220416 NGZ	0,8 1,2 1,6										○	○	○															
Roughing Depth of cut (mm) Feed rate (mm/rev)	 <b>L/RHM</b>	TNMG 160404 LHM TNMG 160408 LHM	0,4 0,8	○	○	○	○	●	○							○	○	○												
		TNMG 220404 LHM TNMG 220408 LHM	0,4 0,8	○	○	○	○	○	○																					
Roughing Depth of cut (mm) Feed rate (mm/rev)	 <b>RHM</b>	TNMG 160404 RHM TNMG 160408 RHM	0,4 0,8	●	○	○	○	●	○							○	○	○												
		TNMG 220404 RHM TNMG 220408 RHM	0,4 0,8	○	○	○	○	○	○																					
Roughing Depth of cut (mm) Feed rate (mm/rev)	 <b>NUZ</b>	TNMG 160404 NUZ TNMG 160408 NUZ TNMG 160412 NUZ TNMG 160416 NUZ TNMG 160420 NUZ	0,4 0,8 1,2 1,6 2,0			○	○					○	○	○																
		TNMG 220408 NUZ TNMG 220412 NUZ TNMG 220416 NUZ	0,8 1,2 1,6			○	●						○	○	○															
		TNMG 270608 NUZ TNMG 270612 NUZ TNMG 270616 NUZ	0,8 1,2 1,6			○	○																							

Neg. Inserts

C

D

K

R

S

T

V

W

● = Euro stock  
○ = Stock item in Japan

**60° Triangle Type** 0° Relief  
With Insert Hole

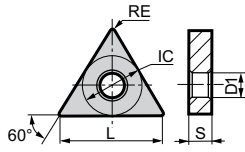

Dimensions (mm)					
TN	L	IC	S	D <sub>1</sub>	
1604..	16,5	9,525	4,76	3,81	
2204..	22,0	12,7	4,76	5,16	
2706..	27,5	15,875	6,35	6,35	

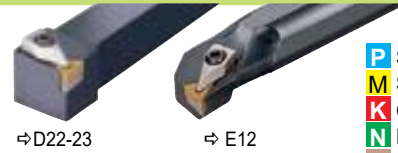

- P Steel
- M Stainless Steel
- K Cast Iron
- N Non-Ferrous Metals
- S Super Alloy
- H Hardened Steel

### TNMM

● M-Class One Sided Bumpy Chipbreaker

Application	Shape	ISO Cat. No.	RE	Carbide											Cermets		Carbide
				Coated											Coated	Uncoated	Uncoated
				P	M	M	K	H	S	P	M	P	K	S	N		
Heavy Roughing	<p><b>NMP</b></p>	<b>TNMM 160404 NMP</b> <b>TNMM 160408 NMP</b> <b>TNMM 160412 NMP</b>  <b>TNMM 220408 NMP</b> <b>TNMM 220412 NMP</b> <b>TNMM 220416 NMP</b>  <b>TNMM 270612 NMP</b> <b>TNMM 270616 NMP</b>	0,4	●	○	○	○	○	○	○	○	○	○	○	○	○	
			0,8	●	●	●	○	○	○	○	○	○	○	○	○	○	○
			1,2	●	●	●	○	○	○	○	○	○	○	○	○	○	○
			0,8	●	○	○	○	○	○	○	○	○	○	○	○	○	○
			1,2	●	●	●	○	○	○	○	○	○	○	○	○	○	○
			1,6	●	●	●	○	○	○	○	○	○	○	○	○	○	○
Heavy Roughing	<p><b>NHG</b></p>	<b>TNMM 160408 NHG</b> <b>TNMM 160412 NHG</b>  <b>TNMM 220408 NHG</b> <b>TNMM 220412 NHG</b> <b>TNMM 220416 NHG</b>	0,8	●	○	○	○	○	○	○	○	○	○	○	○		
			1,2	●	○	○	○	○	○	○	○	○	○	○	○	○	
			0,8	○	○	○	○	○	○	○	○	○	○	○	○	○	
			1,2	○	○	○	○	○	○	○	○	○	○	○	○	○	
			1,6	○	○	○	○	○	○	○	○	○	○	○	○	○	
			1,6	○	○	○	○	○	○	○	○	○	○	○	○	○	
Heavy Roughing	<p><b>NHP</b></p>	<b>TNMM 160408 NHP</b> <b>TNMM 160412 NHP</b>  <b>TNMM 220408 NHP</b> <b>TNMM 220412 NHP</b> <b>TNMM 220416 NHP</b>  <b>TNMM 270612 NHP</b> <b>TNMM 270616 NHP</b>	0,8	○	○	○	○	○	○	○	○	○	○	○	○		
			1,2	○	○	○	○	○	○	○	○	○	○	○	○	○	
			0,8	○	○	○	○	○	○	○	○	○	○	○	○	○	
			1,2	○	○	○	○	○	○	○	○	○	○	○	○	○	
			1,6	○	○	○	○	○	○	○	○	○	○	○	○	○	
			1,6	○	○	○	○	○	○	○	○	○	○	○	○	○	

### TNMN

● M-Class No Chipbreaker

Application	Shape	ISO Cat. No.	RE	Carbide											Cermets		Carbide
				Coated											Coated	Uncoated	Uncoated
				P	M	M	K	H	S	P	M	P	K	S	N		
Medium Cut		<b>TNMN 160408</b> <b>TNMN 160412</b> <b>TNMN 160416</b>	0,8	○	○	○	○	○	○	○	○	○	○	○	○	○	
			1,2	○	○	○	○	○	○	○	○	○	○	○	○	○	
			1,6	○	○	○	○	○	○	○	○	○	○	○	○	○	
			0,8	○	○	○	○	○	○	○	○	○	○	○	○	○	○
			1,2	○	○	○	○	○	○	○	○	○	○	○	○	○	○
			1,6	○	○	○	○	○	○	○	○	○	○	○	○	○	○

● = Euro stock  
 ○ = Stock item in Japan

- Neg. Inserts
- C
  - D
  - K
  - R
  - S
  - T
  - V
  - W



**60° Triangle Type** 0° Relief  
With Insert Hole

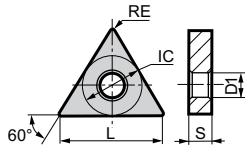

Dimensions (mm)					
TN	L	IC	S	D <sub>1</sub>	
1103..	11,0	6,35	3,18	2,26	
1603..	16,5	9,525	3,18	3,81	
1604..	16,5	9,525	4,76	3,81	



⇒ D15, D22~23

⇒ E12

- P Steel
- M Stainless Steel
- K Cast Iron
- N Non-Ferrous Metals
- S Super Alloy
- H Hardened Steel

# TNGG

● G-Class Double Sided Bumpy Chipbreaker

Application	Shape	ISO Cat. No.	RE	Carbide												Cermets		Carbide	
				Coated												Coated	Uncoated	Uncoated	
				P	M	K	H	S	P	M	T	P	K	S	N				
Finishing	 L/RFT	TNGG 110302 LFT	0,2																
		TNGG 110304 LFT	0,4																
		TNGG 110302 RFT	0,2																
		TNGG 110304 RFT	0,4																
Light Cutting	 L/RST	TNGG 160302 LST	0,2																
		TNGG 160304 LST	0,4																
		TNGG 160308 LST	0,8																
		TNGG 160402 LST	0,2																
		TNGG 160404 LST	0,4																
		TNGG 160408 LST	0,8																
		TNGG 160412 LST	1,2																
		TNGG 160302 RST	0,2																
		TNGG 160304 RST	0,4																
		TNGG 160308 RST	0,8																
		TNGG 160402 RST	0,2																
		TNGG 160404 RST	0,4																
		TNGG 160408 RST	0,8																
		TNGG 160412 RST	1,2																
Finishing	 NSU	TNGG 160402 NSU	0,2																
		TNGG 160404 NSU	0,4																
		TNGG 160408 NSU	0,8																
Finishing	 L/RFY	TNGG 160401 LFY	0,1																
		TNGG 160402 LFY	0,2																
		TNGG 160404 LFY	0,4																
		TNGG 160408 LFY	0,8																
		TNGG 160412 LFY	1,2																
		TNGG 160401 RFY	0,1																
		TNGG 160402 RFY	0,2																
		TNGG 160404 RFY	0,4																
		TNGG 160408 RFY	0,8																
		TNGG 160412 RFY	1,2																
Finishing	 L/RFX	TNGG 160402 LFX	0,2																
		TNGG 160404 LFX	0,4																
		TNGG 160408 LFX	0,8																
		TNGG 160402 RFX	0,2																
		TNGG 160404 RFX	0,4																
		TNGG 160408 RFX	0,8																

● = Euro stock  
 ○ = Stock item in Japan

- Neg. Inserts
- C
  - D
  - K
  - R
  - S
  - T
  - V
  - W

# T TRIANGLE TYPE

## INSERTS FOR TURNING

### Negative Inserts

60° Triangle Type 0° Relief  
With Insert Hole

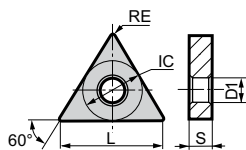

Dimensions (mm)				
TN	L	IC	S	D <sub>1</sub>
1103..	11,0	6,35	3,18	2,26
1604..	16,5	9,525	4,76	3,81
2204..	22,0	12,7	4,76	5,16



⇒ D15, D22~23

⇒ E12

- P Steel
- M Stainless Steel
- K Cast Iron
- N Non-Ferrous Metals
- S Super Alloy
- H Hardened Steel

## TNGG

Application	Shape	ISO Cat. No.	RE	Carbide										Cermet		Carbide					
				Coated										Coated	Uncoated	Uncoated					
				P	M	M	P	K	H	S	P	M	P	K	S	N					
Medium Cut	L/RUM	TNGG 160402 LUM	0,2	●	●	●	●	●	●	●	●	●	●	●	●	●	●	●	●	●	
		TNGG 160404 LUM	0,4	○	○	○	○	○	○	○	○	○	○	○	○	○	○	○	○	○	○
		TNGG 160408 LUM	0,8	○	○	○	○	○	○	○	○	○	○	○	○	○	○	○	○	○	○
		TNGG 160412 LUM	1,2	○	○	○	○	○	○	○	○	○	○	○	○	○	○	○	○	○	○
		TNGG 220404 LUM	0,4	○	○	○	○	○	○	○	○	○	○	○	○	○	○	○	○	○	○
		TNGG 220408 LUM	0,8	○	○	○	○	○	○	○	○	○	○	○	○	○	○	○	○	○	○
	RUM	TNGG 160402 RUM	0,2	○	○	○	○	○	○	○	○	○	○	○	○	○	○	○	○	○	○
		TNGG 160404 RUM	0,4	○	○	○	○	○	○	○	○	○	○	○	○	○	○	○	○	○	○
		TNGG 160408 RUM	0,8	○	○	○	○	○	○	○	○	○	○	○	○	○	○	○	○	○	○
		TNGG 160412 RUM	1,2	○	○	○	○	○	○	○	○	○	○	○	○	○	○	○	○	○	○
		TNGG 220404 RUM	0,4	○	○	○	○	○	○	○	○	○	○	○	○	○	○	○	○	○	○
		TNGG 220408 RUM	0,8	○	○	○	○	○	○	○	○	○	○	○	○	○	○	○	○	○	○
Finishing	NGH	TNGG 160402 NGH	0,2	○	○	○	○	○	○	○	○	○	○	○	○	○	○	○	○	○	
		TNGG 160404 NGH	0,4	○	○	○	○	○	○	○	○	○	○	○	○	○	○	○	○	○	○
		TNGG 160408 NGH	0,8	○	○	○	○	○	○	○	○	○	○	○	○	○	○	○	○	○	○
For Aluminium	L/RAX	TNGG 160402 LAX	0,2	○	○	○	○	○	○	○	○	○	○	○	○	○	○	○	○	○	
		TNGG 160404 LAX	0,4	○	○	○	○	○	○	○	○	○	○	○	○	○	○	○	○	○	○
		TNGG 160408 LAX	0,8	○	○	○	○	○	○	○	○	○	○	○	○	○	○	○	○	○	○
	TNGG 160402 RAX	0,2	○	○	○	○	○	○	○	○	○	○	○	○	○	○	○	○	○	○	
	TNGG 160404 RAX	0,4	○	○	○	○	○	○	○	○	○	○	○	○	○	○	○	○	○	○	○
	TNGG 160408 RAX	0,8	○	○	○	○	○	○	○	○	○	○	○	○	○	○	○	○	○	○	○

## TNGA

Application	Shape	ISO Cat. No.	RE	Carbide										Cermet		Carbide						
				Coated										Coated	Uncoated	Uncoated						
				P	M	M	P	K	H	S	P	M	P	K	S	N						
Medium Cut	TNGA 110308	TNGA 110308	0,8	○	○	○	○	○	○	○	○	○	○	○	○	○	○	○	○	○	○	
		TNGA 160402	0,2	○	○	○	○	○	○	○	○	○	○	○	○	○	○	○	○	○	○	○
		TNGA 160404	0,4	○	○	○	○	○	○	○	○	○	○	○	○	○	○	○	○	○	○	○
		TNGA 160408	0,8	○	○	○	○	○	○	○	○	○	○	○	○	○	○	○	○	○	○	○

### ● G-Class No Chipbreaker

Application	Shape	ISO Cat. No.	RE
Medium Cut	TNGA 110308	TNGA 110308	0,8
		TNGA 160402	0,2
		TNGA 160404	0,4
		TNGA 160408	0,8

- = Euro stock
- = Stock item in Japan

**35° Diamond Type** 0° Relief  
With Insert Hole

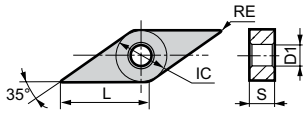

Dimensions (mm)				
VN	L	IC	S	D <sub>1</sub>
1604..	16,6	9,525	4,76	3,81



⇒ D16

- P Steel
- M Stainless Steel
- K Cast Iron
- N Non-Ferrous Metals
- S Super Alloy
- H Hardened Steel

**VNMA** ○○○○○○

● M-Class No Chipbreaker

Application	Shape	ISO Cat. No.	RE
Roughing		VNMA 160404	0,4
		VNMA 160408	0,8
		VNMA 160412	1,2

Carbide Coated												Cermets Coated		Carbide Uncoated												
P	M	K	H	S	N	P	K	S	N	P	K	S	N													
AC8015P	AC8020P	AC8025P	AC8035P	AC6020M	AC6030M	AC6040M	AC630M	AC4010K	AC4015K	AC420K	AC503U	AC5005S	AC5015S	AC5025S	AC1030U	AC530U	T1500Z	T2500Z	T3000Z	T1000A	T1500A	G10E	EH510	EH520	H1	
○	○	○	○	○	○	○	○	○	○	○	○	○	○	○	○	○	○	○	○	○	○	○	○	○	○	○

**VNMG** ○○○○○○

● M-Class Double Sided Bumpy Chipbreaker

Application	Shape	ISO Cat. No.	RE
Fine Finishing	 NFB	VNMG 160404 NFB VNMG 160408 NFB	0,4 0,8
Fine Finishing	 NFA	VNMG 160404 NFA VNMG 160408 NFA	0,4 0,8
Fine Finishing	 NFL	VNMG 160404 NFL VNMG 160408 NFL	0,4 0,8
Fine Finishing	 NFE	VNMG 160402 NFE VNMG 160404 NFE VNMG 160408 NFE VNMG 160412 NFE	0,2 0,4 0,8 1,2
Finishing	 NLU	VNMG 160402 NLU VNMG 160404 NLU VNMG 160408 NLU VNMG 160412 NLU	0,2 0,4 0,8 1,2
Medium Cut	 NEF	VNMG 160402 NEF VNMG 160404 NEF VNMG 160408 NEF	0,2 0,4 0,8

Carbide Coated												Cermets Coated		Carbide Uncoated												
P	M	K	H	S	N	P	K	S	N	P	K	S	N													
AC8015P	AC8020P	AC8025P	AC8035P	AC6020M	AC6030M	AC6040M	AC630M	AC4010K	AC4015K	AC420K	AC503U	AC5005S	AC5015S	AC5025S	AC1030U	AC530U	T1500Z	T2500Z	T3000Z	T1000A	T1500A	G10E	EH510	EH520	H1	
○	○	○	○	○	○	○	○	○	○	○	○	○	○	○	○	○	○	○	○	○	○	○	○	○	○	○

● = Euro stock  
○ = Stock item in Japan

- Inserts
- C
- D
- K
- R
- S
- T
- V
- W



# DIAMOND TYPE INSERTS FOR TURNING

## Negative Inserts

35° Diamond Type 0° Relief  
With Insert Hole

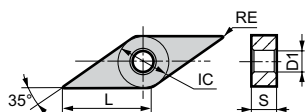

Dimensions (mm)				
VN	L	IC	S	D <sub>1</sub>
1604..	16,6	9,525	4,76	3,81



⇨ D16

- P** Steel
- M** Stainless Steel
- K** Cast Iron
- N** Non-Ferrous Metals
- S** Super Alloy
- H** Hardened Steel

### VNMG

Carbide											Cermets		Carbide												
Coated											Coated		Uncoated		Uncoated										
P	P	M	M	F <sub>M</sub>	K	H	S	S	P <sub>M</sub>	P <sub>M</sub>	P	P	K	S	N										
AC8015P	AC8020P	AC8025P	AC8035P	AC6020M	AC6030M	AC6040M	AC630M	AC4010K	AC4015K	AC420K	AC503U	AC5005S	AC5015S	AC5025S	AC1030U	AC530U	T1500Z	T2500Z	T3000Z	T1000A	T1500A	G10E	EH510	EH520	H1

#### ● M-Class Double Sided Bumpy Chipbreaker

Application	Shape	ISO Cat. No.	RE	AC8015P	AC8020P	AC8025P	AC8035P	AC6020M	AC6030M	AC6040M	AC630M	AC4010K	AC4015K	AC420K	AC503U	AC5005S	AC5015S	AC5025S	AC1030U	AC530U	T1500Z	T2500Z	T3000Z	T1000A	T1500A	G10E	EH510	EH520	H1	
Finishing	 <b>NSU</b>	VNMG 160402 NSU VNMG 160404 NSU VNMG 160408 NSU	0,2	●	●	●	○	●	●	●	○					○	○	○	○	○	○	○	○	○	○	○				
			0,4	●	●	●	○	●	●	●	○						○	○	○	○	○	○	○	○	○	○	○			
			0,8	●	●	●	○	●	●	●	○						○	○	○	○	○	○	○	○	○	○	○			
Medium Cut	 <b>NSE</b>	VNMG 160404 NSE VNMG 160408 NSE	0,4	○	○	○	○														○	○	○	○	○					
			0,8	●	●	●	○																○	○	○	○	○			
Medium Cut	 <b>NSX</b>	VNMG 160404 NSX VNMG 160408 NSX	0,4	○	○	○	○															○	○		○					
			0,8	○	○	○	○																○	○		○				
Medium Cut	 <b>NGU</b>	VNMG 160404 NGU VNMG 160408 NGU VNMG 160412 NGU	0,4	●	●	●	○	●	●	●	○	○					○	○	○	○		○	○		○					
			0,8	●	●	●	○	●	●	●	○	○					○	○	○	○		○	○		○					
			1,2	○	●	●	○	●	●	●	○	○					○	○	○	○		○	○		○					
Medium Cut	 <b>NGE</b>	VNMG 160404 NGE VNMG 160408 NGE VNMG 160412 NGE	0,4	○	○	○	○																							
			0,8	○	●	●	○																							
			1,2	○	○	○	○																							
Medium Cut	 <b>NUG</b>	VNMG 160404 NUG VNMG 160408 NUG VNMG 160412 NUG	0,4				○	○																						
			0,8				○	○																						
			1,2	●			○	○																						
Medium Cut	 <b>NEG</b>	VNMG 160404 NEG VNMG 160408 NEG VNMG 160412 NEG	0,4	○	○	●	○	●	●							○	○	○												
			0,8	○	●	●	○	●	●								○	○	○									○	○	
			1,2	○	●	●	○	●	●								○	○	○											
Medium Cut	 <b>NEX</b>	VNMG 160404 NEX VNMG 160408 NEX	0,4					●	●	●						●	●	●			○									
			0,8					●	●	●							●	●	●			○								

● = Euro stock  
○ = Stock item in Japan



# W TRIGON TYPE

## INSERTS FOR TURNING

### Negative Inserts

80° Trigon Type

0° Relief

With Insert Hole

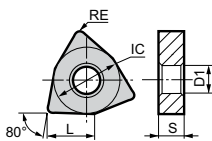

Dimensions (mm)				
WN	L	IC	S	D <sub>1</sub>
0604..	6,5	9,525	4,76	3,81
0804..	8,7	12,7	4,76	5,16



⇨ D17, D24  
D42

⇨ E13

- P** Steel
- M** Stainless Steel
- K** Cast Iron
- N** Non-Ferrous Metals
- S** Super Alloy
- H** Hardened Steel

## WNMG

Application	Shape	ISO Cat. No.	RE	Carbide										Cermets		Carbide													
				Coated										Coated	Uncoated	Uncoated													
				P	M	F <sub>M</sub>	K	H	S	P <sub>M</sub>	P	K	S	N															
				AC8015P	AC8020P	AC8025P	AC8035P	AC6020M	AC6030M	AC6040M	AC630M	AC4010K	AC4015K	AC503U	AC5005S	AC5015S	AC5025S	AC1030U	AC530U	T1500Z	T2500Z	T3000Z	T1000A	T1500A	G10E	EH510	EH520	H1	
Fine Finishing	 <b>NFB</b>	<b>WNMG 060404 NFB</b> <b>WNMG 060408 NFB</b>	0,4 0,8																	○	○	○	○	○					
Fine Finishing	 <b>NFA</b>	<b>WNMG 080402 NFA</b> <b>WNMG 080404 NFA</b> <b>WNMG 080408 NFA</b>	0,2 0,4 0,8																	○	○	○	○	○					
Fine Finishing	 <b>NFL</b>	<b>WNMG 080404 NFL</b> <b>WNMG 080408 NFL</b>	0,4 0,8			○					○									●	○	●	●	●					
Fine Finishing	 <b>NFE</b>	<b>WNMG 060404 NFE</b> <b>WNMG 060408 NFE</b>	0,4 0,8	○	○	○	○	○	○	○	○									○	○	○	○	○					
Fine Finishing	 <b>NFE</b>	<b>WNMG 080402 NFE</b> <b>WNMG 080404 NFE</b> <b>WNMG 080408 NFE</b> <b>WNMG 080412 NFE</b>	0,2 0,4 0,8 1,2	○	○	○	○	○	○	○	○									○	○	○	○	○					
Finishing	 <b>NLU</b>	<b>WNMG 060404 NLU</b> <b>WNMG 060408 NLU</b> <b>WNMG 060412 NLU</b>	0,4 0,8 1,2	○	○	○	○	○	○	○	○										○								
Finishing	 <b>NLU</b>	<b>WNMG 080404 NLU</b> <b>WNMG 080408 NLU</b> <b>WNMG 080412 NLU</b>	0,4 0,8 1,2	●	●	●	○	○	○	○	○									●	●	●	●	●					
Finishing	 <b>NLU-W</b>	<b>WNMG 060404 NLU-W</b> <b>WNMG 060408 NLU-W</b>	0,4 0,8	●	●	●	○	○	○	○	○									●	○			●					
Finishing	 <b>NLU-W</b>	<b>WNMG 080404 NLU-W</b> <b>WNMG 080408 NLU-W</b> <b>WNMG 080412 NLU-W</b>	0,4 0,8 1,2	●	●	●	●	○	○	○	○									●	○	●	●	●	●				

● = Euro stock  
○ = Stock item in Japan

# W TRIGON TYPE

## INSERTS FOR TURNING

80° Trigon Type 0° Relief  
With Insert Hole

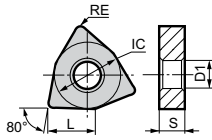

Dimensions (mm)					
WN	L	IC	S	D <sub>1</sub>	
0604..	6,5	9,525	4,76	3,81	
06T3..	6,5	9,525	3,97	3,81	
0804..	8,7	12,7	4,76	5,16	



⇨ D17, D24  
D42

⇨ E13

- P Steel
- M Stainless Steel
- K Cast Iron
- N Non-Ferrous Metals
- S Super Alloy
- H Hardened Steel

### WNMG

Carbide												Cermets		Carbide	
Coated												Coated	Uncoated	Uncoated	
P	M	K	H	S	P	M	P	K	S	N					

Application	Shape	ISO Cat. No.	RE	AC8015P	AC8020P	AC8025P	AC8035P	AC6020M	AC6030M	AC6040M	AC630M	AC4010K	AC4015K	AC420K	AC503U	AC5005S	AC5015S	AC5025S	AC1030U	AC530U	T1500Z	T2500Z	T3000Z	T1000A	T1500A	G10E	EH510	EH620	H1	
Finishing	NEF	WNMG 060404 NEF	0,4	○	●	○	○	●	●	●						○	○	○												
		WNMG 060408 NEF	0,8	○	●	○	○	●	●	●							○	○	○											
Finishing	NEF	WNMG 080404 NEF	0,4	○	●	○	○	●	●	●	●					○	○	○												
		WNMG 080408 NEF	0,8	○	●	○	○	●	●	●							●	●	●											
Finishing	NSU	WNMG 060404 NSU	0,4	●	●	○	○	●	○	○	●						●	●					○							
		WNMG 060408 NSU	0,8	●	●	○	○	●	○	○	●							●	●					○						
Finishing	NSU	WNMG 060412 NSU	1,2	○	○	○	○																							
		WNMG 06T304 NSU	0,4			○																								
Finishing	NSU	WNMG 06T308 NSU	0,8			○																								
		WNMG 080404 NSU	0,4	●	●	●	●	●	●	●	●						○	○	○											
Finishing	NSU	WNMG 080408 NSU	0,8	●	●	●	●	●	●	●							○	○	○											
		WNMG 080412 NSU	1,2	●	●	●	●	●	●	○																				
Finishing	NSE	WNMG 080404 NSE	0,4	●	●	○																								
		WNMG 080408 NSE	0,8	●	●	○																								
Finishing	NSE	WNMG 080412 NSE	1,2	●	●	○																								
		WNMG 060404 NSE-W	0,4	○	○	○																								
Finishing	NSE-W	WNMG 060408 NSE-W	0,8	○	○	○																								
		WNMG 080404 NSE-W	0,4	●	●	●																								
Finishing	NSE-W	WNMG 080408 NSE-W	0,8	●	●	●																								
		WNMG 080412 NSE-W	1,2	●	●	●																								
Finishing	NSX	WNMG 080404 NSX	0,4	○	○	○																								
		WNMG 080408 NSX	0,8	●	○	○	●																							
Finishing	NSX	WNMG 080412 NSX	1,2	○	○	○																								
		Medium Cut	NGU	WNMG 060404 NGU	0,4	●	●	○																						
WNMG 060408 NGU	0,8			●	●	○																								
Medium Cut	NGU	WNMG 060412 NGU	1,2	●	●	○																								
		WNMG 080404 NGU	0,4	●	●	●	●	●	●	●	●																			
Medium Cut	NGU	WNMG 080408 NGU	0,8	●	●	●	●	●	●	●																				
		WNMG 080412 NGU	1,2	●	●	●	●	●	●	●																				
Medium Cut	NGU-W	WNMG 060408 NGU-W	0,8	○	○	○																								
		WNMG 080408 NGU-W	0,8	●	●	●																								
Medium Cut	NGU-W	WNMG 080412 NGU-W	1,2	●	●	●																								
		WNMG 080412 NGU-W	1,2	●	●	●																								

● = Euro stock  
○ = Stock item in Japan

Neg. Inserts



# W TRIGON TYPE

## INSERTS FOR TURNING

### Negative Inserts

80° Trigon Type

0° Relief

With Insert Hole

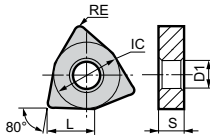

Dimensions (mm)				
WN	L	IC	S	D <sub>1</sub>
0604..	6,5	9,525	4,76	3,81
06T3..	6,5	9,525	3,97	3,81
0804..	8,7	12,7	4,76	5,16



⇨ D17, D24  
D42

⇨ E13

- P Steel
- M Stainless Steel
- K Cast Iron
- N Non-Ferrous Metals
- S Super Alloy
- H Hardened Steel

## WNMG

Application	Shape	ISO Cat. No.	RE	Carbide													Cermets		Carbide										
				Coated													Coated	Uncoated	Uncoated										
				P	M	F <sub>M</sub>	K	H	S	P <sub>M</sub>	P	K	S	N	P	K	S	N											
Medium Cut		<b>WNMG 060408 NGE</b> <b>WNMG 060412 NGE</b>  <b>WNMG 080404 NGE</b> <b>WNMG 080408 NGE</b> <b>WNMG 080412 NGE</b> <b>WNMG 080416 NGE</b>	0,8 1,2  0,4 0,8 1,2 1,6	AC8015P	AC8020P	AC8025P	AC8035P	AC6020M	AC6030M	AC6040M	AC630M	AC4010K	AC4015K	AC420K	AC503U	AC5005S	AC5015S	AC5025S	AC1030U	AC530U	T1500Z	T2500Z	T3000Z	T1000A	T1500A	G10E	EH510	EH520	H1
Medium Cut		<b>WNMG 060404 NUG</b> <b>WNMG 060408 NUG</b>  <b>WNMG 06T304 NUG</b> <b>WNMG 06T308 NUG</b>  <b>WNMG 080404 NUG</b> <b>WNMG 080408 NUG</b> <b>WNMG 080412 NUG</b>	0,4 0,8  0,4 0,8 1,2	AC8015P	AC8020P	AC8025P	AC8035P	AC6020M	AC6030M	AC6040M	AC630M	AC4010K	AC4015K	AC420K	AC503U	AC5005S	AC5015S	AC5025S	AC1030U	AC530U	T1500Z	T2500Z	T3000Z	T1000A	T1500A	G10E	EH510	EH520	H1
Medium Cut		<b>WNMG 060408 NEG</b> <b>WNMG 060412 NEG</b>  <b>WNMG 080404 NEG</b> <b>WNMG 080408 NEG</b> <b>WNMG 080412 NEG</b>	0,8 1,2  0,4 0,8 1,2	AC8015P	AC8020P	AC8025P	AC8035P	AC6020M	AC6030M	AC6040M	AC630M	AC4010K	AC4015K	AC420K	AC503U	AC5005S	AC5015S	AC5025S	AC1030U	AC530U	T1500Z	T2500Z	T3000Z	T1000A	T1500A	G10E	EH510	EH520	H1
Medium Cut		<b>WNMG 060404 NEX</b> <b>WNMG 060408 NEX</b>  <b>WNMG 080404 NEX</b> <b>WNMG 080408 NEX</b> <b>WNMG 080412 NEX</b>	0,4 0,8  0,4 0,8 1,2	AC8015P	AC8020P	AC8025P	AC8035P	AC6020M	AC6030M	AC6040M	AC630M	AC4010K	AC4015K	AC420K	AC503U	AC5005S	AC5015S	AC5025S	AC1030U	AC530U	T1500Z	T2500Z	T3000Z	T1000A	T1500A	G10E	EH510	EH520	H1
Medium Cut		<b>WNMG 080408 NUP</b> <b>WNMG 080412 NUP</b>	0,8 1,2	AC8015P	AC8020P	AC8025P	AC8035P	AC6020M	AC6030M	AC6040M	AC630M	AC4010K	AC4015K	AC420K	AC503U	AC5005S	AC5015S	AC5025S	AC1030U	AC530U	T1500Z	T2500Z	T3000Z	T1000A	T1500A	G10E	EH510	EH520	H1
Medium Cut		<b>WNMG 080408 NEM</b> <b>WNMG 080412 NEM</b>	0,8 1,2	AC8015P	AC8020P	AC8025P	AC8035P	AC6020M	AC6030M	AC6040M	AC630M	AC4010K	AC4015K	AC420K	AC503U	AC5005S	AC5015S	AC5025S	AC1030U	AC530U	T1500Z	T2500Z	T3000Z	T1000A	T1500A	G10E	EH510	EH520	H1

### ● M-Class Double Sided Bumpy Chipbreaker

Neg. Inserts

C

D

K

R

S

T

V

W

● = Euro stock  
○ = Stock item in Japan

**80° Trigon Type** 0° Relief  
With Insert Hole

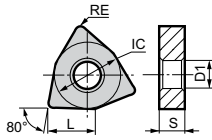

Dimensions (mm)				
WN	L	IC	S	D <sub>1</sub>
0604..	6,5	9,525	4,76	3,81
0804..	8,7	12,7	4,76	5,16



⇒ D17, D24  
D42

⇒ E13

- P Steel
- M Stainless Steel
- K Cast Iron
- N Non-Ferrous Metals
- S Super Alloy
- H Hardened Steel

## WNMG

● M-Class Double Sided Bumpy Chipbreaker

Application	Shape	ISO Cat. No.	RE	Carbide										Cermet		Carbide
				Coated										Coated	Uncoated	Uncoated
				P	M	K	H	S	P	M	P	K	S	N		
Roughing	 <b>NUX</b>	<b>WNMG 080404 NUX</b> <b>WNMG 080408 NUX</b> <b>WNMG 080412 NUX</b>	0,4	○	●	●	●	●	●	●	●	●	●	●	●	
			0,8	●	●	●	●	●	●	●	●	●	●	●	●	
			1,2	●	●	●	●	●	●	●	●	●	●	●	●	●
Roughing	 <b>NMU</b>	<b>WNMG 060408 NMU</b> <b>WNMG 060412 NMU</b>  <b>WNMG 080408 NMU</b> <b>WNMG 080412 NMU</b> <b>WNMG 080416 NMU</b>	0,8	●	○	●	●	●	●	●	●	●	●	●		
			1,2	●	●	●	●	●	●	●	●	●	●	●		
			0,8	●	●	●	●	●	●	●	○	○	○	○	○	
Roughing	 <b>NME</b>	<b>WNMG 060408 NME</b> <b>WNMG 060412 NME</b>  <b>WNMG 080408 NME</b> <b>WNMG 080412 NME</b> <b>WNMG 080416 NME</b>	0,8	○	○	○	○	○	○	○	○	○	○	○		
			1,2	○	●	○	○	○	○	○	○	○	○	○		
			0,8	●	●	●	●	●	●	●	○	○	○	○	○	
Roughing	 <b>NMX</b>	<b>WNMG 080408 NMX</b> <b>WNMG 080412 NMX</b>	0,8	○	○	○	○	○	○	○	○	○	○	○		
			1,2	○	○	○	○	○	○	○	○	○	○	○		
			0,8	○	○	○	○	○	○	○	○	○	○	○		
Roughing	 <b>NGZ</b>	<b>WNMG 060408 NGZ</b> <b>WNMG 060412 NGZ</b>  <b>WNMG 080404 NGZ</b> <b>WNMG 080408 NGZ</b> <b>WNMG 080412 NGZ</b>	0,8	○	○	○	○	○	○	○	○	○	○			
			1,2	○	○	○	○	○	○	○	○	○	○	○		
			0,4	○	○	○	○	○	○	○	○	○	○	○		
Roughing	 <b>NUZ</b>	<b>WNMG 080404 NUZ</b> <b>WNMG 080408 NUZ</b> <b>WNMG 080412 NUZ</b>	0,4	○	○	○	○	○	○	○	○	○	○			
			0,8	○	○	○	○	○	○	○	○	○	○			
			1,2	○	○	○	○	○	○	○	○	○	○			

● = Euro stock  
○ = Stock item in Japan

- Neg. Inserts
- C
  - D
  - K
  - R
  - S
  - T
  - V
  - W



# W TRIGON TYPE

## INSERTS FOR TURNING

### Negative Inserts

80° Trigon Type

0° Relief

With Insert Hole

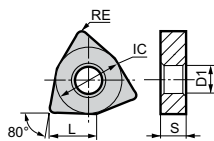

Dimensions (mm)				
WN	L	IC	S	D <sub>1</sub>
0804..	8,7	12,7	4,76	5,16



⇒ D17, D24

⇒ E13

- P** Steel
- M** Stainless Steel
- K** Cast Iron
- N** Non-Ferrous Metals
- S** Super Alloy
- H** Hardened Steel

## WNMM

### ● M-Class One Sided Bumpy Chipbreaker

Application	Shape	ISO Cat. No.	RE	Carbide											Cermet		Carbide					
				Coated											Coated	Uncoated	Uncoated					
				P	M	M	K	H	S	P	M	P	K	S	N							
Heavy Roughing	 <b>NMP</b>	<b>WNMM 080408 NMP</b> <b>WNMM 080412 NMP</b>	0,8	●	●	●	●	●	●	●	●	●	●	●	●	●	●	●	●	●	●	●
			1,2	●	●	●	●	●	●	●	●	●	●	●	●	●	●	●	●	●	●	●
Heavy Roughing	 <b>NHG</b>	<b>WNMM 080408 NHG</b> <b>WNMM 080412 NHG</b>	0,8	●	●	●	●	●	●	●	●	●	●	●	●	●	●	●	●	●	●	●
			1,2	●	●	●	●	●	●	●	●	●	●	●	●	●	●	●	●	●	●	●

## WNMA

### ● M-Class No Chipbreaker

Application	Shape	ISO Cat. No.	RE	Carbide											Cermet		Carbide						
				Coated											Coated	Uncoated	Uncoated						
				P	M	M	K	H	S	P	M	P	K	S	N								
Roughing		<b>WNMA 080408</b> <b>WNMA 080412</b> <b>WNMA 080416</b>	0,8	●	●	●	●	●	●	●	●	●	●	●	●	●	●	●	●	●	●	●	
			1,2	●	●	●	●	●	●	●	●	●	●	●	●	●	●	●	●	●	●	●	●
			1,6	●	●	●	●	●	●	●	●	●	●	●	●	●	●	●	●	●	●	●	●

## WNGG

### ● G-Class Double Sided Bumpy Chipbreaker

Application	Shape	ISO Cat. No.	RE	Carbide											Cermet		Carbide					
				Coated											Coated	Uncoated	Uncoated					
				P	M	M	K	H	S	P	M	P	K	S	N							
Finishing	 <b>NSU</b>	<b>WNGG 080404 NSU</b>	0,4	●	●	●	●	●	●	●	●	●	●	●	●	●	●	●	●	●	●	●
				●	●	●	●	●	●	●	●	●	●	●	●	●	●	●	●	●	●	●

● = Euro stock  
○ = Stock item in Japan

**80° Diamond Type**      **7° Relief**  
 With Insert Hole

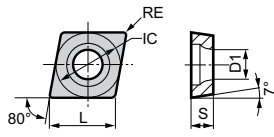

Dimensions (mm)					
CC	L	IC	S	D <sub>1</sub>	
03X1..	3,55	3,5	1,4	1,9	
04X1..	4,37	4,3	1,8	2,3	
0602..	6,4	6,35	2,38	2,8	
09T3..	9,7	9,525	3,97	4,4	



- P** Steel
- M** Stainless Steel
- K** Cast Iron
- N** Non-Ferrous Metals
- S** Super Alloy
- H** Hardened Steel

### CCET

● E-Class

Application	Shape	ISO Cat. No.	RE
Finishing Depth of cut (mm)  Feed rate (mm/rev)  <b>L/RFY</b>	CCET 03X1003 LFY CCET 03X101 LFY CCET 03X102 LFY CCET 03X104 LFY  CCET 04X1003 LFY CCET 04X101 LFY CCET 04X102 LFY CCET 04X104 LFY  CCET 060201 LFY CCET 060202 LFY  CCET 09T301 LFY CCET 09T302 LFY	03	0,03
		01	0,1
		02	0,2
		04	0,4
		03	0,03
		01	0,1
		02	0,2
		04	0,4
		01	0,1
		02	0,2
		01	0,1
		02	0,2
	CCET 03X1003 RFY CCET 03X101 RFY CCET 03X102 RFY CCET 03X104 RFY  CCET 04X1003 RFY CCET 04X101 RFY CCET 04X102 RFY CCET 04X104 RFY  CCET 060201 RFY CCET 060202 RFY  CCET 09T301 RFY CCET 09T302 RFY	03	0,03
		01	0,1
		02	0,2
		04	0,4
		03	0,03
		01	0,1
		02	0,2
		04	0,4
		01	0,1
		02	0,2
		01	0,1
		02	0,2

Carbide													Cermet		Carbide											
Coated													Coated	Uncoated	Uncoated											
P	M	M	M	K	H	S	S	P	M	P	K	S	N													
AC8015P	AC8020P	AC8025P	AC8035P	AC6020M	AC6030M	AC6040M	AC630M	AC4010K	AC4015K	AC420K	AC503U	AC5005S	AC5015S	AC5025S	AC1030U	AC530U	T1500Z	T2500Z	T3000Z	T1000A	T1500A	G10E	EH510	EH620	H1	
●	●	●	●	●	●	●	●	●	●	●	●	●	●	●	○	○	○	○	○	○	○	○	○	○	○	○

● = Euro stock  
 ○ = Japan stock

Pos. Inserts

- C
- D
- K
- R
- S
- T
- V
- W

# C DIAMOND TYPE

## INSERTS FOR TURNING

### 7° Positive Inserts

80° Diamond Type

7° Relief  
With Insert Hole

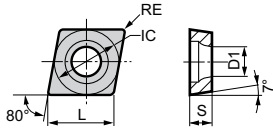

Dimensions (mm)				
CC	L	IC	S	D <sub>1</sub>
03X1..	3,55	3,5	1,4	1,9
04X1..	4,37	4,3	1,8	2,3
0602..	6,4	6,35	2,38	2,8
09T3..	9,7	9,525	3,97	4,4

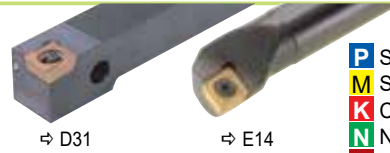

- P** Steel
- M** Stainless Steel
- K** Cast Iron
- N** Non-Ferrous Metals
- S** Super Alloy
- H** Hardened Steel

## CCGT

Carbide											Cermet		Carbide												
Coated											Coated	Uncoated	Uncoated												
P	M	M	M	K	H	S	P	M	P	K	S	N													
AC8015P	AC8020P	AC8025P	AC8035P	AC6020M	AC6030M	AC6040M	AC630M	AC4010K	AC4015K	AC420K	AC503U	AC5005S	AC5015S	AC5025S	AC1030U	AC530U	T1500Z	T2500Z	T3000Z	T1000A	T1500A	G10E	EH510	EH520	H1

### G-Class

Application	Shape	ISO Cat. No.	RE	AC8015P	AC8020P	AC8025P	AC8035P	AC6020M	AC6030M	AC6040M	AC630M	AC4010K	AC4015K	AC420K	AC503U	AC5005S	AC5015S	AC5025S	AC1030U	AC530U	T1500Z	T2500Z	T3000Z	T1000A	T1500A	G10E	EH510	EH520	H1		
Finishing Depth of cut (mm) Feed rate (mm/rev)	NFC	CCGT 060201M NFC CCGT 060202M NFC CCGT 060204M NFC	<0,1 <0,2 <0,4																												
		CCGT 09T301M NFC CCGT 09T302M NFC CCGT 09T304M NFC	<0,1 <0,2 <0,4																												
		CCGT 0602003 LFX CCGT 060201 LFX CCGT 060202 LFX CCGT 060204 LFX	0,03 0,1 0,2 0,4																												
Finishing Depth of cut (mm) Feed rate (mm/rev)	L/RFX	CCGT 09T3003 LFX CCGT 09T301 LFX CCGT 09T302 LFX CCGT 09T304 LFX CCGT 09T308 LFX	0,03 0,1 0,2 0,4 0,8																												
		CCGT 0602003 RFX CCGT 060201 RFX CCGT 060202 RFX CCGT 060204 RFX	0,03 0,1 0,2 0,4																												
		CCGT 09T3003 RFX CCGT 09T301 RFX CCGT 09T302 RFX CCGT 09T304 RFX CCGT 09T308 RFX	0,03 0,1 0,2 0,4 0,8																												
Finishing Depth of cut (mm) Feed rate (mm/rev)	L/RFYS	CCGT 03X1003 LFYS CCGT 03X101 LFYS CCGT 03X102 LFYS CCGT 03X104 LFYS	0,03 0,1 0,2 0,4																												
		CCGT 04X1003 LFYS CCGT 04X101 LFYS CCGT 04X102 LFYS CCGT 04X104 LFYS	0,03 0,1 0,2 0,4																												
		CCGT 03X1003 RFYS CCGT 03X101 RFYS CCGT 03X102 RFYS CCGT 03X104 RFYS	0,03 0,1 0,2 0,4																												
Finishing Depth of cut (mm) Feed rate (mm/rev)	L/RFYS	CCGT 04X1003 RFYS CCGT 04X101 RFYS CCGT 04X102 RFYS CCGT 04X104 RFYS	0,03 0,1 0,2 0,4																												

● = Euro stock  
○ = Japan stock

**80° Diamond Type** 7° Relief  
With Insert Hole

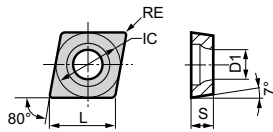

Dimensions (mm)					
CC	L	IC	S	D <sub>1</sub>	
03X1..	3,55	3,5	1,4	1,9	
04X1..	4,37	4,3	1,8	2,3	
0602..	6,4	6,35	2,38	2,8	
0903..	9,7	9,525	3,18	4,4	
09T3..	9,7	9,525	3,97	4,4	
1204..	12,9	12,7	4,76	5,5	



⇨ E14

- P Steel
- M Stainless Steel
- K Cast Iron
- N Non-Ferrous Metals
- S Super Alloy
- H Hardened Steel

# CCGT

● G-Class

Application	Shape	ISO Cat. No.	RE
<b>Finishing</b> Depth of cut (mm)  Feed rate (mm/rev) 	L/RFY	CCGT 03X101 LFY CCGT 03X102 LFY CCGT 03X104 LFY CCGT 04X101 LFY CCGT 04X102 LFY CCGT 04X104 LFY	0,1 0,2 0,4 0,1 0,2 0,4
		CCGT 03X101 RFY CCGT 03X102 RFY CCGT 03X104 RFY CCGT 04X101 RFY CCGT 04X102 RFY CCGT 04X104 RFY	0,1 0,2 0,4 0,1 0,2 0,4
<b>Light Cut</b> Depth of cut (mm)  Feed rate (mm/rev) 	NAG	CCGT 060202 NAG CCGT 060204 NAG CCGT 09T302 NAG CCGT 09T304 NAG CCGT 09T308 NAG CCGT 120404 NAG CCGT 120408 NAG	0,2 0,4 0,2 0,4 0,8 0,4 0,8
<b>Light cut</b> Depth of cut (mm)  Feed rate (mm/rev) 	NSI	CCGT 09T301M NSI CCGT 09T302M NSI CCGT 09T304M NSI	<0,1 <0,2 <0,4
<b>Light cut</b> Depth of cut (mm)  Feed rate (mm/rev) 	NSC	CCGT 0602003 NSC CCGT 09T3003 NSC CCGT 060201M NSC CCGT 060202M NSC CCGT 060204M NSC CCGT 080201M NSC CCGT 080202M NSC CCGT 090301M NSC CCGT 090302M NSC CCGT 09T301M NSC CCGT 09T302M NSC CCGT 09T304M NSC CCGT 09T308M NSC	0,03 0,03 <0,1 <0,2 <0,4 <0,1 <0,2 <0,1 <0,1 <0,2 <0,1 <0,1 <0,2 <0,4 <0,8
<b>For Aluminum</b> Depth of cut (mm)  Feed rate (mm/rev) 	L/RAY	CCGT 060202 LAY CCGT 060204 LAY CCGT 09T301 LAY CCGT 09T302 LAY CCGT 09T304 LAY CCGT 060201 RAY CCGT 060202 RAY CCGT 060204 RAY CCGT 09T301 RAY CCGT 09T302 RAY CCGT 09T304 RAY	0,2 0,4 0,1 0,2 0,4 0,1 0,2 0,4 0,1 0,2 0,4

Carbide												Cermet		Carbide												
Coated												Coated	Uncoated	Uncoated												
P	M	K	N	S	H	P	M	P	K	S	N	P	U	K	S	N										
AC8015P	AC8020P	AC8025P	AC8035P	AC6020M	AC6030M	AC6040M	AC630M	AC4010K	AC4015K	AC420K	AC503J	AC5005S	AC5015S	AC5025S	AC1030U	AC530U	T1500Z	T2500Z	T3000Z	T1000A	T1500A	G10E	EH510	EH620	H1	
●	●	●	●	●	●	●	●	●	●	●	●	●	●	●	●	●	○	○	○	○	○	○	○	○	○	○

● = Euro stock  
 ○ = Japan stock

- Pos. Inserts
- C
  - D
  - K
  - R
  - S
  - T
  - V
  - W

# C DIAMOND TYPE

## INSERTS FOR TURNING

### 7° Positive Inserts

80° Diamond Type 7° Relief  
With Insert Hole

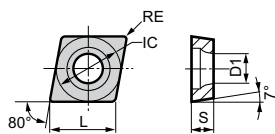

Dimensions (mm)				
CC	L	IC	S	D <sub>1</sub>
0602..	6,4	6,35	2,38	2,8
09T3..	9,7	9,525	3,97	4,4
1204..	12,9	12,7	4,76	5,5



⇒ D31

⇒ E14

- P Steel
- M Stainless Steel
- K Cast Iron
- N Non-Ferrous Metals
- S Super Alloy
- H Hardened Steel

## CCMT

Carbide											Cermets		Carbide												
Coated											Coated	Uncoated	Uncoated												
P	P	M	M	K	H	S	P	P	K	S	N														
AC8015P	AC8020P	AC8025P	AC8035P	AC6020M	AC6030M	AC6040M	AC630M	AC4010K	AC4015K	AC420K	AC503U	AC5005S	AC5015S	AC5025S	AC1030U	AC530U	T1500Z	T2500Z	T3000Z	T1000A	T1500A	G10E	EH510	EH520	H1

### ● M-Class

Application	Shape	ISO Cat. No.	RE	AC8015P	AC8020P	AC8025P	AC8035P	AC6020M	AC6030M	AC6040M	AC630M	AC4010K	AC4015K	AC420K	AC503U	AC5005S	AC5015S	AC5025S	AC1030U	AC530U	T1500Z	T2500Z	T3000Z	T1000A	T1500A	G10E	EH510	EH520	H1	
Finishing	 <b>NFB</b>	CCMT 060202 NFB	0,2																											
		CCMT 060204 NFB	0,4																											
		CCMT 09T302 NFB CCMT 09T304 NFB CCMT 09T308 NFB	0,2 0,4 0,8																											
Finishing – Light Cut	 <b>NFP</b>	CCMT 060202 NFP	0,2																											
		CCMT 060204 NFP CCMT 060208 NFP	0,4 0,8	●																										
		CCMT 09T302 NFP CCMT 09T304 NFP CCMT 09T308 NFP	0,2 0,4 0,8																											
Finishing	 <b>NLU</b>	CCMT 060202 NLU	0,2	●	●	●		●	●	●	●										●	○	●	○	○					
		CCMT 060204 NLU	0,4	●	●	●		●	●	●	●											●	○	●	○	○				
		CCMT 09T302 NLU CCMT 09T304 NLU CCMT 09T308 NLU	0,2 0,4 0,8	●	●	●		●	●	●	●											●	○	●	○	○				
Finishing	 <b>NLU-W</b>	CCMT 09T304 NLU-W	0,4	●	●	●		●													●	●	●		○					
		CCMT 09T308 NLU-W	0,8	●	●	●		●			●											●	●	●		○				
Light Cut	 <b>NLB</b>	CCMT 060202 NLB	0,2	○	○	○	○	○	●	●	●										●	○	●	●	●					
		CCMT 060204 NLB CCMT 060208 NLB	0,4 0,8	○	○	○	○	○	●	●	●	○										●	○	●	●	●				
		CCMT 09T302 NLB CCMT 09T304 NLB CCMT 09T308 NLB	0,2 0,4 0,8	○	○	○	○	○	●	●	●	●										●	○	●	●	●				
Light Cut	 <b>NSU</b>	CCMT 060202 NSU	0,2	●	●	●	●	●	●	●	●					○	●	●	●	●	●	●	●	●	●					
		CCMT 060204 NSU CCMT 060208 NSU	0,4 0,8	●	●	●	●	●	●	●	●	●					○	●	●	●	●	●	●	●	●	●				
		CCMT 09T302 NSU CCMT 09T304 NSU CCMT 09T308 NSU	0,2 0,4 0,8	○	●	●	●	●	●	●	●	○					○	●	●	●	●	●	●	●	●	●	●			
Light Cut	 <b>NSU</b>	CCMT 120404 NSU	0,4	●	●	●	●	●	●	●	●					●	○	○			●	●	●	●	●					
		CCMT 120408 NSU	0,8	●	●	●	●	●	●	●	●	●					●	○	○			●	●	●	●	●				

● = Euro stock  
○ = Japan stock

Pos. Inserts

C

D

K

R

S

T

V

W

80° Diamond Type 7° Relief  
With Insert Hole

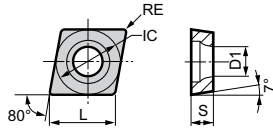

Dimensions (mm)				
C	L	IC	S	D <sub>1</sub>
0602..	6,4	6,35	2,38	2,8
0803..	8,0	7,94	3,18	3,4
0903..	9,7	9,525	3,18	4,4
09T3..	9,7	9,525	3,97	4,4
1204..	12,9	12,7	4,76	5,5



⇒ E15

- P Steel
- M Stainless Steel
- K Cast Iron
- N Non-Ferrous Metals
- S Super Alloy
- H Hardened Steel

## CCMT/-W

● M-Class

Application	Shape	ISO Cat. No.	RE	Carbide										Cermet		Carbide			
				Coated										Coated	Uncoated	Uncoated			
				P	M	K	H	S	P	P	K	S	N						
Light Cut	 <b>NUS</b>	<b>CCMT 09T308 NUS</b>	0,8																
Light Cut	 <b>NSC</b>	<b>CCMT 060204 NSC</b> <b>CCMT 080304 NSC</b> <b>CCMT 090308 NSC</b> <b>CCMT 120408 NSC</b>	0,4																
			0,4																
			0,8																
			0,8																
Light Cut	 <b>NSK</b>	<b>CCMT 060204 NSK</b> <b>CCMT 060208 NSK</b> <b>CCMT 09T304 NSK</b> <b>CCMT 09T308 NSK</b> <b>CCMT 120404 NSK</b> <b>CCMT 120408 NSK</b> <b>CCMT 120412 NSK</b>	0,4																
			0,8																
			0,4																
			0,8																
			0,4																
			0,8																
Roughing – Light Cut	 <b>NGU</b>	<b>CCMT 060204 NGU</b> <span style="color: yellow;">New</span> <b>CCMT 060208 NGU</b> <span style="color: yellow;">New</span> <b>CCMT 09T304 NGU</b> <span style="color: yellow;">New</span> <b>CCMT 09T308 NGU</b> <span style="color: yellow;">New</span> <b>CCMT 120408 NGU</b> <span style="color: yellow;">New</span>	0,4																
			0,8																
			0,4																
			0,8																
			0,8																
Roughing	 <b>NMU</b>	<b>CCMT 09T304 NMU</b> <b>CCMT 09T308 NMU</b>	0,4																
			0,8																
Roughing	 <b>CCMW</b>	<b>CCMW 060204</b> <b>CCMW 09T304</b> <b>CCMW 09T308</b>	0,4																
			0,4																
			0,8																

● = Euro stock  
 ○ = Japan stock

Pos. Inserts

C

D

K

R

S

T

V

W



# C DIAMOND TYPE

## INSERTS FOR TURNING

### 11° Positive Inserts

80° Diamond Type 11° Relief  
With Insert Hole

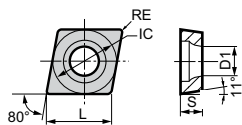

Dimensions (mm)					
CP	L	IC	S	D <sub>1</sub>	
0802..	8,0	7,94	2,38	3,4	
0903..	9,7	9,525	3,18	4,4	
1204..	12,9	12,7	4,76	5,5	



⇨ E15

- P Steel
- M Stainless Steel
- K Cast Iron
- N Non-Ferrous Metals
- S Super Alloy
- H Hardened Steel

## CPGT ○○○○ NSD

Application	Shape	ISO Cat. No.	RE	Carbide											Cermets		Carbide										
				Coated											Coated	Uncoated	Uncoated										
				P	M	P	M	K	H	S	P	M	P	K	S	N											
Finishing ~ Light Cut  NSD CPMT 080202 NSD CPMT 080204 NSD CPMT 080208 NSD CPMT 090302 NSD CPMT 090304 NSD CPMT 090308 NSD CPMT 120402 NSD CPMT 120404 NSD CPMT 120408 NSD	0,2	0,4	0,8	0,2	0,4	0,8	0,2	0,4	0,8	0,2	0,4	0,8	0,2	0,4	0,8	0,2	0,4	0,8	0,2	0,4	0,8	0,2	0,4	0,8	0,2	0,4	0,8

## CPMT ○○○○-■

Application	Shape	ISO Cat. No.	RE	Carbide											Cermets		Carbide										
				Coated											Coated	Uncoated	Uncoated										
				P	M	P	M	K	H	S	P	M	P	K	S	N											
Finishing  NFB NLU NLU-W NLB CPMT 080204 NFB CPMT 090304 NFB CPMT 090308 NFB CPMT 080204 NLU CPMT 090304 NLU CPMT 090308 NLU CPMT 090304 NLU-W CPMT 090308 NLU-W CPMT 080204 NLB CPMT 090304 NLB CPMT 090308 NLB	0,4	0,4	0,8	0,4	0,4	0,8	0,4	0,4	0,8	0,4	0,4	0,8	0,4	0,4	0,8	0,4	0,4	0,8	0,4	0,4	0,8	0,4	0,4	0,8	0,4	0,4	0,8

● = Euro stock  
 ○ = Japan stock

Pos. Inserts

C

D

K

R

S

T

V

W

**80° Diamond Type** 11° Relief  
With Insert Hole

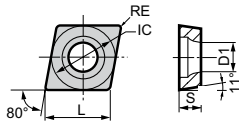

CP	L	IC	S	D <sub>1</sub>
0602..	6,4	6,35	2,38	2,8
0802..	8,0	7,94	2,38	3,4
0903..	9,7	9,525	3,18	4,4
09T3..	9,7	9,525	3,97	4,4
1204..	12,9	12,7	4,76	5,5
1604..	16,1	15,875	4,76	6,5



⇒ E15

- P Steel
- M Stainless Steel
- K Cast Iron
- N Non-Ferrous Metals
- S Super Alloy
- H Hardened Steel

### CPMT/-H

Carbide										Cermet		Carbide
Coated										Coated	Uncoated	Uncoated
P	M	K	H	S	P	P	K	S	N			

● M-Class

Application	Shape	ISO Cat. No.	RE	AC8015P	AC8020P	AC8025P	AC8035P	AC6020M	AC6030M	AC6040M	AC630M	AC4010K	AC4015K	AC420K	AC503U	AC5005S	AC5015S	AC5025S	AC1030U	AC530U	T1500Z	T2500Z	T3000Z	T1000A	T1500A	G10E	EH510	EH520	H1			
<b>Light Cut</b>  <b>NSU</b>		CPMT 080204 NSU	0,4	○	○	○	○	○	○	○	○	○	○	○	○	○	○	○	○	○	○	○	○	○	○	○	○	○	○	○		
		CPMT 080208 NSU	0,8	○	○	○	○	○	○	○	○	○	○	○	○	○	○	○	○	○	○	○	○	○	○	○	○	○	○	○	○	
		CPMT 090304 NSU	0,4	○	○	○	○	○	○	○	○	○	○	○	○	○	○	○	○	○	○	○	○	○	○	○	○	○	○	○	○	
		CPMT 090308 NSU	0,8	○	●	○	○	○	○	○	○	○	○	○	○	○	○	○	○	○	○	○	○	○	○	○	○	○	○	○	○	
<b>Light Cut</b>  <b>NUS</b>		CPMT 060204 NUS	0,4			●			○																							
		CPMT 080308 NUS	0,8			●			○																							
		CPMT 09T308 NUS	0,8			●			○																							
<b>Light-Medium Cut</b>  <b>NGU</b>		CPMT 090304 NGU <span style="color: red; font-weight: bold;">New</span>	0,4	○	○	○	○	○	○	○	○	○	○	○	○	○	○	○	○	○	○	○	○	○	○	○	○	○	○	○		
		CPMT 090308 NGU <span style="color: red; font-weight: bold;">New</span>	0,8	○	○	○	○	○	○	○	○	○	○	○	○	○	○	○	○	○	○	○	○	○	○	○	○	○	○	○	○	
<b>Light-Medium Cut</b>  <b>NMU</b>		CPMT 080204 NMU	0,4	○	○	○	○	○	○	○	○	○	○	○	○	○	○	○	○	○	○	○	○	○	○	○	○	○	○	○	○	
		CPMT 080208 NMU	0,8	○	○	○	○	○	○	○	○	○	○	○	○	○	○	○	○	○	○	○	○	○	○	○	○	○	○	○	○	○
		CPMT 090304 NMU	0,4	○	○	○	○	○	○	○	○	○	○	○	○	○	○	○	○	○	○	○	○	○	○	○	○	○	○	○	○	○
		CPMT 090308 NMU	0,8	○	○	○	○	○	○	○	○	○	○	○	○	○	○	○	○	○	○	○	○	○	○	○	○	○	○	○	○	○

● = Euro stock  
 ○ = Japan stock

- Pos. Inserts
- C
  - D
  - K
  - R
  - S
  - T
  - V
  - W



**55° Diamond Type** 7° Relief  
With Insert Hole

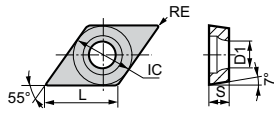

Dimensions (mm)				
DC	L	IC	S	D <sub>1</sub>
0702..	7,7	6,35	2,38	2,8
11T3..	11,6	9,525	3,97	4,4



⇨ D32-33

⇨ E16-17

- P Steel
- M Stainless Steel
- K Cast Iron
- N Non-Ferrous Metals
- S Super Alloy
- H Hardened Steel

## DCGT

● G-Class

Application	Shape	ISO Cat. No.	RE						
Finishing Depth of cut (mm)  Feed rate (mm/rev)	 <b>LFY</b>	<b>DCGT 0702003 LFY</b> DCGT 070201 LFY DCGT 070202 LFY DCGT 070204 LFY <b>DCGT 11T3003 LFY</b> DCGT 11T301 LFY DCGT 11T302 LFY DCGT 11T304 LFY	0,03 0,1 0,2 0,4 0,03 0,1 0,2 0,4						
		Finishing Depth of cut (mm)  Feed rate (mm/rev)	 <b>RFY</b>	<b>DCGT 0702003 RFY</b> DCGT 070201 RFY DCGT 070202 RFY DCGT 070204 RFY <b>DCGT 11T3003 RFY</b> DCGT 11T301 RFY DCGT 11T302 RFY DCGT 11T304 RFY	0,03 0,1 0,2 0,4 0,03 0,1 0,2 0,4				
				Finishing ~ Light Cut Depth of cut (mm)  Feed rate (mm/rev)	 <b>L/RSD</b>	<b>DCGT 070202 LSD</b> DCGT 070204 LSD <b>DCGT 11T304 LSD</b> DCGT 11T308 LSD	0,2 0,4 0,4 0,8		
						Light Cut Depth of cut (mm)  Feed rate (mm/rev)	 <b>NAG</b>	<b>DCGT 070202 NAG</b> DCGT 070204 NAG <b>DCGT 11T302 NAG</b> DCGT 11T304 NAG DCGT 11T308 NAG	0,2 0,4 0,2 0,4 0,8

Carbide												Cermet		Carbide												
Coated												Coated	Uncoated	Uncoated												
P	M	M	M	K	H	S	P	P	K	S	N															
AC8015P	AC8020P	AC8025P	AC8035P	AC6020M	AC6030M	AC6040M	AC630M	AC4010K	AC4015K	AC420K	AC503U	AC5005S	AC5015S	AC5025S	AC1030U	AC530U	T1500Z	T2500Z	T3000Z	T1000A	T1500A	G10E	EH510	EH520	H1	
○	○	○	○	○	○	○	○	○	○	○	○	○	○	○	○	○	○	○	○	○	○	○	○	○	○	○

● = Euro stock  
 ○ = Japan stock

- Pos. Inserts
- C
  - D
  - K
  - R
  - S
  - T
  - V
  - W

# DIAMOND TYPE

## INSERTS FOR TURNING

### 7° Positive Inserts

55° Diamond Type

7° Relief  
With Insert Hole

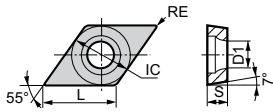

Dimensions (mm)				
DC	L	IC	S	D <sub>1</sub>
0702..	7,7	6,35	2,38	2,8
0902..	9,7	7,94	2,38	3,4
1103..	11,6	9,525	3,18	4,4
11T3..	11,6	9,525	3,97	4,4



⇒ D32-33

⇒ E16-17

- P** Steel
- M** Stainless Steel
- K** Cast Iron
- N** Non-Ferrous Metals
- S** Super Alloy
- H** Hardened Steel

## DCGT/-W

Carbide											Cermets		Carbide											
Coated											Coated	Uncoated	Uncoated											
P	M	M	M	K	H	S	P	P	K	S	N			K	S	N								
AC8015P	AC8020P	AC8025P	AC8035P	AC6020M	AC6030M	AC6040M	AC630M	AC4010K	AC4015K	AC420K	AC503U	AC5005S	AC5015S	AC5025S	AC1030U	AC530U	T1500Z	T3000Z	T1000A	T1500A	G10E	EH510	EH520	H1

### G-Class

Application	Shape	ISO Cat. No.	RE	AC8015P	AC8020P	AC8025P	AC8035P	AC6020M	AC6030M	AC6040M	AC630M	AC4010K	AC4015K	AC420K	AC503U	AC5005S	AC5015S	AC5025S	AC1030U	AC530U	T1500Z	T3000Z	T1000A	T1500A	G10E	EH510	EH520	H1		
Light Cut Depth of cut (mm) Feed rate (mm/rev)	NSI	DCGT 070201M NSI	<0,1								●						●	●	●	●	●	○	○	○						
		DCGT 070202M NSI	<0,2								●							●	●	●	●	●	○	○	○					
		DCGT 070204M NSI	<0,4								●							●	●	●	●	●	○	○	○					
		DCGT 11T301M NSI	<0,1								●							●	●	●	●	●	○	○	○					
		DCGT 11T302M NSI	<0,2								●							●	●	●	●	●	○	○	○					
		DCGT 11T304M NSI	<0,4								●							●	●	●	●	●	○	○	○					
Light cut Depth of cut (mm) Feed rate (mm/rev)	NSC	DCGT 0702003 NSC	0,03																		○	○		○	○					
		DCGT 11T3003 NSC	0,03																		○	○	●		○	○				
		DCGT 070201M NSC	<0,1																		●	●	●	●	●	●	●			
		DCGT 070202M NSC	<0,2																		●	●	●	●	●	●	●			
		DCGT 070204M NSC	<0,4																		●	●	●	●	●	●	●			
		DCGT 090201M NSC	<0,1																				○	○		○	○			
For Aluminum Depth of cut (mm) Feed rate (mm/rev)	L/RAY	DCGT 11T301 LAY	0,1																										○	
		DCGT 11T302 LAY	0,2																										○	
		DCGT 11T304 LAY	0,4																										○	
		DCGT 070202 RAY	0,2																										○	
		DCGT 070204 RAY	0,4																										○	
		DCGT 11T301 RAY	0,1																										○	
Light Cut		DCGW 070202	0,2																										○	
		DCGW 070204	0,4																										○	
		DCGW 070208	0,8																										○	
		DCGW 11T302	0,2																										○	
		DCGW 11T304	0,4																										○	
		DCGW 11T308	0,8																										○	

● = Euro stock  
○ = Japan stock

**55° Diamond Type** 7° Relief  
With Insert Hole

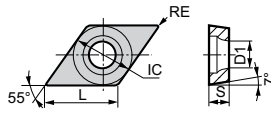

Dimensions (mm)				
DC	L	IC	S	D <sub>1</sub>
0702..	7,7	6,35	2,38	2,8
11T3..	11,6	9,525	3,97	4,4



⇨ D32-33

⇨ E16-17

- P Steel
- M Stainless Steel
- K Cast Iron
- N Non-Ferrous Metals
- S Super Alloy
- H Hardened Steel



● M-Class

Application	Shape	ISO Cat. No.	RE	Carbide													Cermets		Carbide												
				Coated													Coated	Uncoated	Uncoated												
				P	M	M	K	H	S	S	P	P	K	S	N																
				AC8015P	AC8020P	AC8025P	AC8035P	AC6020M	AC6030M	AC6040M	AC630M	AC4010K	AC4015K	AC420K	AC503J	AC5005S	AC5015S	AC5025S	AC1030U	AC530U	T1500Z	T2500Z	T3000Z	T1000A	T1500A	G10E	EH510	EH520	H1		
Finishing	NFB	DCMT 070202 NFB DCMT 070204 NFB DCMT 070208 NFB DCMT 11T302 NFB DCMT 11T304 NFB DCMT 11T308 NFB	0,2																		○	○	○	○	○						
			0,4																				○	○	○	○	○				
			0,8																				○	○	○	○	○				
			0,2																				○	○	○	○	○				
			0,4																				○	○	○	○	○				
Finishing	NFP	DCMT 070202 NFP DCMT 070204 NFP DCMT 11T302 NFP DCMT 11T304 NFP DCMT 11T308 NFP DCMT 11T312 NFP	0,2																		●	●	●	●	●						
			0,4																			●	●	●	●	●					
			0,2																			●	●	●	●	●					
			0,4																			●	●	●	●	●					
			0,8																			●	●	●	●	●					
Finishing	NLU	DCMT 070202 NLU DCMT 070204 NLU DCMT 11T302 NLU DCMT 11T304 NLU DCMT 11T308 NLU	0,2	●	○	○															●	○	○	○	○	○					
			0,4	●	●	●																●	○	○	○	○	○				
			0,2	●	●	●																●	○	○	○	○	○				
			0,4	●	●	●																●	○	○	○	○	○				
			0,8	●	●	●																●	○	○	○	○	○				
Light Cut	NLB	DCMT 070202 NLB DCMT 070204 NLB DCMT 070208 NLB DCMT 11T302 NLB DCMT 11T304 NLB DCMT 11T308 NLB	0,2		○	○															●	○	○	○	○	○					
			0,4		○	○																●	○	○	○	○	○				
			0,8		○	○																●	○	○	○	○	○				
			0,2		○	○																●	○	○	○	○	○				
			0,4		○	○																●	○	○	○	○	○				
Light Cut	NSU	DCMT 070202 NSU DCMT 070204 NSU DCMT 070208 NSU DCMT 11T302 NSU DCMT 11T304 NSU DCMT 11T308 NSU	0,2	●	●	●										●	●	●		●	○	○	○	○	○	○					
			0,4	●	●	●											●	●	●		●	○	○	○	○	○	○				
			0,8	●	●	●											●	●	●		●	○	○	○	○	○	○				
			0,2	●	●	●											●	●	●		●	○	○	○	○	○	○				
			0,4	●	●	●											●	●	●		●	○	○	○	○	○	○				
Light Cut	NSK	DCMT 070204 NSK DCMT 070208 NSK DCMT 11T304 NSK DCMT 11T308 NSK DCMT 11T312 NSK	0,4			●															●	○	○	○	○	○					
			0,8			●																●	○	○	○	○	○				
			0,4			●																●	○	○	○	○	○				
			0,8			●																●	○	○	○	○	○				
			1,2	●		●																●	○	○	○	○	○				
Roughing-Light Cut	NGU	DCMT 070204 NGU DCMT 070208 NGU DCMT 11T302 NGU DCMT 11T304 NGU DCMT 11T308 NGU DCMT 11T312 NGU	0,4	●	●	●															●	○	○	○	○	○					
			0,8	●	●	●																●	○	○	○	○	○				
			0,2	●	●	●																●	○	○	○	○	○				
			0,4	●	●	●																●	○	○	○	○	○				
			0,8	●	●	●																●	○	○	○	○	○				
Roughing	NMU	DCMT 11T304 NMU DCMT 11T308 NMU	0,4	●	●	●														●	○	○	○	○	○						
			0,8	●	●	●															●	○	○	○	○	○					
Roughing	DCMW 070204 DCMW 070208 DCMW 11T304 DCMW 11T308		0,4																		○	○	○	○	○						
			0,8																			○	○	○	○	○					
			0,4																			○	○	○	○	○					
			0,8																			○	○	○	○	○					
Finishing	DCMX 11T308 NLUW		0,8	●																●											

● = Euro stock  
○ = Japan stock

- Pos. Inserts
- C
  - D
  - K
  - R
  - S
  - T
  - V
  - W





90° Square Type 7° Relief  
With Insert Hole

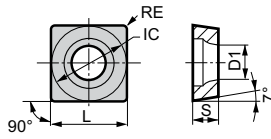

Dimensions (mm)					
SC	L	IC	S	D <sub>1</sub>	
0702..	7,94	7,94	2,38	3,4	
0903..	9,525	9,525	3,18	4,4	
09T3..	9,525	9,525	3,97	4,4	
1204..	12,7	12,7	4,76	5,5	



⇨ D36

"S ... SSKC" - Type  
 (⇨ Stock in Japan)

- P Steel
- M Stainless Steel
- K Cast Iron
- N Non-Ferrous Metals
- S Super Alloy
- H Hardened Steel

## SCGT ○○○○○○ ○-□

● G-Class

Application	Shape	ISO Cat. No.	RE	Carbide										Cermets		Carbide														
				Coated										Coated	Uncoated	Uncoated														
				P	M	M	K	H	S	P	P	P	K	S	N															
				AC8015P	AC8020P	AC8025P	AC8035P	AC6020M	AC6030M	AC6040M	AC630M	AC4010K	AC4015K	AC420K	AC503U	AC5005S	AC5015S	AC5025S	AC1030U	AC530U	T1500Z	T2500Z	T3000Z	T1000A	T1500A	G10E	EH510	EH620	H1	
Finishing	 L/RFX	SCGT 09T302 LFX SCGT 09T304 LFX	0,2 0,4																											
		SCGT 120404 LFX	0,4																											
		SCGT 09T302 RFX SCGT 09T304 RFX	0,2 0,4																											
	SCGT 120404 RFX	0,4																												
Light Cut	 NSC	SCGT 070201M NSC SCGT 070202M NSC	<0,1 <0,2																											
		SCGT 090301M NSC SCGT 090302M NSC	<0,1 <0,2																											
		SCGT 09T301M NSC SCGT 09T302M NSC	<0,1 <0,2																											

● = Euro stock  
 ○ = Japan stock

- Pos. Inserts
- C
  - D
  - K
  - R
  - S
  - T
  - V
  - W

# S SQUARE TYPE

## INSERTS FOR TURNING

### 7° Positive Inserts

90° Square Type

7° Relief  
With Insert Hole

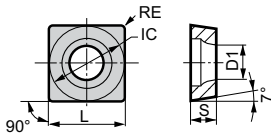

Dimensions (mm)				
SC	L	IC	S	D <sub>1</sub>
09T3..	9,525	9,525	3,97	4,4
1204..	12,7	12,7	4,76	5,5

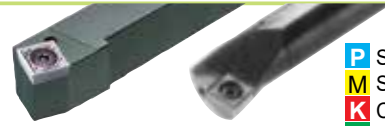

⇨ D36

"S ... SSKC" - Type  
(⇨ Stock in Japan)

- P** Steel
- M** Stainless Steel
- K** Cast Iron
- N** Non-Ferrous Metals
- S** Super Alloy
- H** Hardened Steel

## SCMT/-W

Carbide										Cermets		Carbide		
Coated										Coated	Uncoated	Uncoated		
P	M	M	M	K	H	S	P	P	K	S	N			

### ● M-Class

Application	Shape	ISO Cat. No.	RE	AC8015P	AC8020P	AC8025P	AC8035P	AC6020M	AC6030M	AC6040M	AC630M	AC4010K	AC4015K	AC420K	AC503U	AC5005S	AC5015S	AC5025S	AC1030U	AC530U	T1500Z	T2500Z	T3000Z	T1000A	T1500A	G10E	EH510	EH520	H1	
Finishing	 <b>NFB</b>	SCMT 09T304 NFB SCMT 09T308 NFB	0,4 0,8																											
		SCMT 120404 NFP	0,4																											
Finishing	 <b>NFP</b>	SCMT 09T304 NFP SCMT 09T308 NFP	0,4 0,8																											
		SCMT 120404 NFP	0,4																											
Finishing	 <b>NLU</b>	SCMT 09T304 NLU SCMT 09T308 NLU	0,4 0,8	○	○	○		○	○																					
		SCMT 120412 NLU	1,2	●	●																									
Light Cut	 <b>NLB</b>	SCMT 09T304 NLB SCMT 09T308 NLB	0,4 0,8	○	○	○		○	○																					
Light Cut	 <b>NSU</b>	SCMT 09T304 NSU SCMT 09T308 NSU	0,4 0,8	●	●	●	●	●	●	●	●		●			●	●	●												
		SCMT 120404 NSU SCMT 120408 NSU	0,4 0,8	○	●	●	●	●	●	●	●	●																		
Light Cut	 <b>NSK</b>	SCMT 09T304 NSK SCMT 09T308 NSK	0,4 0,8		●	●	●																							
		SCMT 120404 NSK SCMT 120408 NSK SCMT 120412 NSK	0,4 0,8 1,2		●	●	●																							
Light-Medium Cut	 <b>NGU</b>	SCMT 09T304 NGU SCMT 09T308 NGU	0,4 0,8	●	●	●	○	○	●	○			●			●	●													
		SCMT 120408 NGU	0,8	○	●	●	○	●																						
Light-Medium Cut	 <b>NMU</b>	SCMT 09T308 NMU	0,8	○	●	●	○	●	○	○	○	○	○	○	○	○	○													
		SCMT 120408 NMU SCMT 120412 NMU	0,8 1,2	●	●	●	●																							
		SCMW 09T308	0,8										○	○	○															
		SCMW 120408 SCMW 120412	0,8 1,2											○	○	○														

● = Euro stock  
○ = Japan stock

90° Square Type 11° Relief  
With Insert Hole

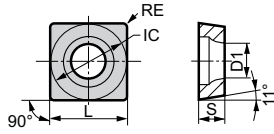

Dimensions (mm)				
SP	L	IC	S	D <sub>1</sub>
0602..	6,35	6,35	2,38	2,8
0703..	7,94	7,94	3,18	3,4
0903..	9,525	9,525	3,18	3,4
09T3..	9,525	9,525	3,97	4,4
1204..	12,7	12,7	4,76	5,5
1504..	15,875	15,875	4,76	6,5



⇒ E18

- P Steel
- M Stainless Steel
- K Cast Iron
- N Non-Ferrous Metals
- S Super Alloy
- H Hardened Steel

## SPMT/-H

	Carbide											Cermet		Carbide													
	Coated											Coated	Uncoated	Uncoated													
	P	M	M	K	H	S	P	P	K	S	N																
Application	AC8015P	AC8020P	AC8025P	AC8035P	AC6020M	AC6030M	AC6040M	AC630M	AC4010K	AC4015K	AC420K	AC503J	AC5005S	AC5015S	AC5025S	AC1030U	AC530U	T1500Z	T2500Z	T3000Z	T1000A	T1500A	G10E	EH510	EH620	H1	
RE																											
Finishing																											
Finishing																											
Finishing																											
Light Cut																											
Light Cut																											
Light - Medium Cut																											
Light - Medium Cut																											

● M-Class

Application	Shape	ISO Cat. No.	RE
Finishing	NFB	SPMT 090304 NFB SPMT 090308 NFB	0,4 0,8
Finishing	NLU	SPMT 090304 NLU SPMT 090308 NLU	0,4 0,8
Finishing	NFK	SPMT 090304 NFK	0,4
Light Cut	NUS	SPMT 060204 NUS SPMT 070308 NUS SPMT 09T308 NUS	0,4 0,8 0,8
Light Cut	NUS	SPMH 090308 NUS SPMH 120408 NUS SPMH 150408 NUS	0,8 0,8 0,8
Light - Medium Cut	NLB	SPMT 090304 NLB SPMT 090308 NLB	0,4 0,8
Light - Medium Cut	NSF	SPMT 090304 NSF SPMT 090308 NSF	0,4 0,8

● = Euro stock  
 ○ = Japan stock

- Pos. Inserts
- - 
  - 
  - 
  - 
  - 
  - 
  -

# S SQUARE TYPE

## INSERTS FOR TURNING

11° Positive Inserts

90° Square Type 11° Relief With Insert Hole

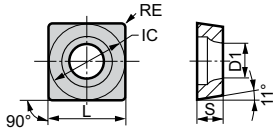

Dimensions (mm)				
SP	L	IC	S	D <sub>1</sub>
0703..	7,94	7,94	3,18	3,4
0903..	9,525	9,525	3,18	3,4

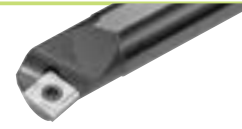

⇒ E18

- P** Steel
- M** Stainless Steel
- K** Cast Iron
- N** Non-Ferrous Metals
- S** Super Alloy
- H** Hardened Steel

## SPGW

Application	Shape	ISO Cat. No.	RE	Carbide													Cermert		Carbide													
				Coated													Coated	Uncoated	Uncoated													
				P	M	M	K	H	S	P	M	P	K	S	N																	
Light Cut		SPGW 090304 T SPGW 070304 SPGW 090304	0,4 0,4 0,4	AC8015P	AC8020P	AC8025P	AC8035P	AC6020M	AC6030M	AC6040M	AC630M	AC4010K	AC4015K	AC420K	AC503U	AC5005S	AC5015S	AC5025S	AC1030U	AC530U	T1500Z	T2500Z	T3000Z	T1000A	T1500A	G10E	EH510	EH520	H1			
				●	○	○	○	○	○	○	○	○	○	○	○	○	○	○	○	○	○	○	○	○	○	○	○	○	○	○	○	○

● G-Class No Chipbreaker

## SPGT

Application	Shape	ISO Cat. No.	RE	Carbide													Cermert		Carbide													
				Coated													Coated	Uncoated	Uncoated													
				P	M	M	K	H	S	P	M	P	K	S	N																	
Finishing - Light Cut	 L/RSD	SPGT 090302 LSD SPGT 090304 LSD SPGT 090308 LSD	0,2 0,4 0,8	AC8015P	AC8020P	AC8025P	AC8035P	AC6020M	AC6030M	AC6040M	AC630M	AC4010K	AC4015K	AC420K	AC503U	AC5005S	AC5015S	AC5025S	AC1030U	AC530U	T1500Z	T2500Z	T3000Z	T1000A	T1500A	G10E	EH510	EH520	H1			
				○	○	○	○	○	○	○	○	○	○	○	○	○	○	○	○	○	○	○	○	○	○	○	○	○	○	○	○	○

● G-Class

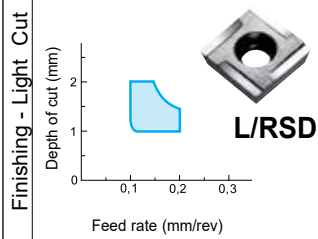

● = Euro stock  
○ = Japan stock

Pos. Inserts

C

D

K

R

S

T

V

W





# T TRIANGLE TYPE

## INSERTS FOR TURNING

5° Positive Inserts

60° Triangle Type

5° Relief  
With Insert Hole

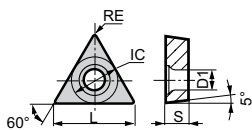

Dimensions (mm)				
TB	L	IC	S	D <sub>1</sub>
0601..	6,9	3,97	1,59	2,2



⇒ E20

- P** Steel
- M** Stainless Steel
- K** Cast Iron
- N** Non-Ferrous Metals
- S** Super Alloy
- H** Hardened Steel

## TBGT

Application	Shape	ISO Cat. No.	RE	Carbide													Cermet		Carbide		
				Coated													Coated	Uncoated	Uncoated		
				P	M	K	H	S	N	P	K	S	N	P	K	S	N				
Finishing Depth of cut (mm) Feed rate (mm/rev)		TBGT 060102 LFW TBGT 060104 LFW	0,2	●	●	●	●	●	●	●	●	●	●	●	●	●	○	○	○	○	
			0,4	○	○	○	○	○	○	○	○	○	○	○	○	○	○	○	○	○	○
Finishing Depth of cut (mm) Feed rate (mm/rev)		TBGT 060102 LFX TBGT 060104 LFX	0,2	●	●	●	●	●	●	●	●	●	●	●	●	○	○	○	○		
			0,4	○	○	○	○	○	○	○	○	○	○	○	○	○	○	○	○	○	
Finishing Depth of cut (mm) Feed rate (mm/rev)		TBGT 060101 LFY TBGT 060102 LFY TBGT 060104 LFY	0,1	○	○	○	○	○	○	○	○	○	○	○	○	○	○	○	○		
			0,2	○	○	○	○	○	○	○	○	○	○	○	○	○	○	○	○	○	
Finishing-Light Cut Depth of cut (mm) Feed rate (mm/rev)		TBGT 060102 LW TBGT 060104 LW	0,2	○	○	○	○	○	○	○	○	○	○	○	○	○	○	○	○		
			0,4	○	○	○	○	○	○	○	○	○	○	○	○	○	○	○	○	○	
For Aluminum Depth of cut (mm) Feed rate (mm/rev)		TBGT 060101 LAY TBGT 060101 RAY	0,1	○	○	○	○	○	○	○	○	○	○	○	○	○	○	○	○		
			0,1	○	○	○	○	○	○	○	○	○	○	○	○	○	○	○	○	○	

## TBGW

Application	Shape	ISO Cat. No.	RE	Carbide													Cermet		Carbide		
				Coated													Coated	Uncoated	Uncoated		
				P	M	K	H	S	N	P	K	S	N	P	K	S	N				
Light Cut		TBGW 060102 TBGW 060204	0,2	○	○	○	○	○	○	○	○	○	○	○	○	○	○	○	○	○	
			0,4	○	○	○	○	○	○	○	○	○	○	○	○	○	○	○	○	○	○

● G-Class No Chipbreaker

Application	Shape	ISO Cat. No.	RE
Light Cut		TBGW 060102 TBGW 060204	0,2
			0,4

- = Euro stock
- = Japan stock

Pos. Inserts

C

D

K

R

S

T

V

W

60° Triangle Type

7° Relief  
With Insert Hole

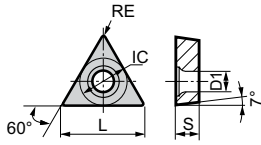

Dimensions (mm)				
TC	L	IC	S	D <sub>1</sub>
0802..	8,2	4,76	2,38	2,3
0902..	9,62	5,56	2,38	2,5
1102..	11,0	6,35	2,38	2,8
16T3..	16,5	9,525	3,97	4,3



- P** Steel
- M** Stainless Steel
- K** Cast Iron
- N** Non-Ferrous Metals
- S** Super Alloy
- H** Hardened Steel

### TCGT

● G-Class

Application	Shape	ISO Cat. No.	RE	Carbide										Cermet		Carbide															
				Coated										Coated	Uncoated	Uncoated															
				P	M	K	H	S	P	P	K	S	N																		
				AC8015P	AC8020P	AC8025P	AC8035P	AC6020M	AC6030M	AC6040M	AC630M	AC4010K	AC4015K	AC420K	AC503J	AC5005S	AC5015S	AC5025S	AC1030U	AC530U	T1500Z	T2500Z	T3000Z	T1000A	T1500A	G10E	EH510	EH520	H1		
Finishing Depth of cut (mm) Feed rate (mm/rev)		TCGT 090201 LFX	0,1																												
		TCGT 090202 LFX	0,2																												
		TCGT 110201 LFX	0,1																												
		TCGT 110202 LFX	0,2																												
		TCGT 110301 LFX	0,1																												
		TCGT 110302 LFX	0,2																												
Finishing Depth of cut (mm) Feed rate (mm/rev)		TCGT 090201 LFX	0,1																												
		TCGT 090202 LFX	0,2																												
		TCGT 110201 LFX	0,1																												
		TCGT 110202 LFX	0,2																												
		TCGT 110301 LFX	0,1																												
		TCGT 110302 LFX	0,2																												
Light cut Depth of cut (mm) Feed rate (mm/rev)		TCGT 110204M NSI	<0,4																												
Light Cut Depth of cut (mm) Feed rate (mm/rev)		TCGT 110202 NAG	0,2																												
		TCGT 110204 NAG	0,4																												
		TCGT 16T304 NAG	0,4																												
		TCGT 16T308 NAG	0,8																												
Light Cut Depth of cut (mm) Feed rate (mm/rev)		TCGT 080201M NSC	<0,1																												
		TCGT 080202M NSC	<0,2																												
		TCGT 090201M NSC	<0,1																												
		TCGT 090202M NSC	<0,2																												
		TCGT 110201M NSC	<0,1																												
		TCGT 110202M NSC	<0,2																												

● = Euro stock  
○ = Japan stock

Pos. Inserts



# T TRIANGLE TYPE

## INSERTS FOR TURNING

7° Positive Inserts

60° Triangle Type

7° Relief  
With Insert Hole

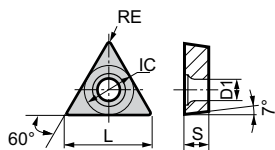

Dimensions (mm)				
TC	L	IC	S	D <sub>1</sub>
0902...	9,6	5,56	2,38	2,5
1102...	11,0	6,35	2,38	2,8
16T3...	16,5	9,525	3,97	4,3



⇨ D37

⇨ E19

- P Steel
- M Stainless Steel
- K Cast Iron
- N Non-Ferrous Metals
- S Super Alloy
- H Hardened Steel

## TCMT/-W

Carbide											Cermets		Carbide												
Coated											Coated	Uncoated	Uncoated												
P	P	M	M	K	H	S	P	P	K	S	N														
AC8015P	AC8020P	AC8025P	AC8035P	AC6020M	AC6030M	AC6040M	AC630M	AC4010K	AC4015K	AC420K	AC503U	AC5005S	AC5015S	AC5025S	AC1030U	AC530U	T1500Z	T2500Z	T3000Z	T1000A	T1500A	G10E	EH510	EH520	H1

### ● M-Class

Application	Shape	ISO Cat. No.	RE	AC8015P	AC8020P	AC8025P	AC8035P	AC6020M	AC6030M	AC6040M	AC630M	AC4010K	AC4015K	AC420K	AC503U	AC5005S	AC5015S	AC5025S	AC1030U	AC530U	T1500Z	T2500Z	T3000Z	T1000A	T1500A	G10E	EH510	EH520	H1			
Finishing	 <b>NFB</b>	<b>TCMT 110204 NFB</b> <b>TCMT 110208 NFB</b>	0,4																													
			0,8																													
Finishing	 <b>NFP</b>	<b>TCMT 090202 NFP</b> <b>TCMT 090204 NFP</b> <b>TCMT 090208 NFP</b>	0,2																													
			0,4																													
			0,8																													
			0,8																													
Finishing	 <b>NLU</b>	<b>TCMT 110204 NLU</b> <b>TCMT 110208 NLU</b>	0,4																													
			0,8																													
Light Cut	 <b>NLB</b>	<b>TCMT 110204 NLB</b> <b>TCMT 110208 NLB</b>	0,4																													
			0,8																													
Light Cut	 <b>NSU</b>	<b>TCMT 110204 NSU</b> <b>TCMT 110208 NSU</b>	0,4																													
			0,8																													
Light Cut	 <b>NSK</b>	<b>TCMT 110204 NSK</b> <b>TCMT 110208 NSK</b>	0,4																													
			0,8																													
			0,4																													
			1,2																													
Light Cut	 <b>TCMW</b>	<b>TCMW 110204</b> <b>TCMW 110208</b>	0,4																													
			0,8																													
			0,4																													
			1,2																													

● = Euro stock  
○ = Japan stock

60° Triangle Type 11° Relief  
With Insert Hole

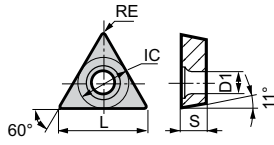

Dimensions (mm)				
TP	L	IC	S	D <sub>1</sub>
0802..	8,2	4,76	2,38	2,4
0902..	9,6	5,56	2,38	2,8
1103..	11,0	6,35	3,18	3,4
1603..	16,5	9,525	3,18	4,4



⇒ E20

- P Steel
- M Stainless Steel
- K Cast Iron
- N Non-Ferrous Metals
- S Super Alloy
- H Hardened Steel

# TPGT

● G-Class

Application	Shape	ISO Cat. No.	RE	Carbide										Cermet		Carbide															
				Coated										Coated	Uncoated	Uncoated															
				P	M	K	H	S	P	P	K	S	N																		
				AC8015P	AC8020P	AC8025P	AC8035P	AC6020M	AC6030M	AC6040M	AC630M	AC4010K	AC4015K	AC420K	AC503U	AC5005S	AC5015S	AC5025S	AC1030U	AC530U	T1500Z	T2500Z	T3000Z	T1000A	T1500A	G10E	EH510	EH520	H1		
Finishing	NFC	TPGT 110302M NFC TPGT 110304M NFC	<0,2																												
			<0,4																												
Finishing	L/RFW	TPGT 080202 LFW TPGT 080204 LFW	0,2																												
			0,4																												
		0,2																													
			0,4																												
Finishing	L/RFX	TPGT 080202 LFX TPGT 080204 LFX		0,2																											
			0,4																												
		0,4																													
			0,2																												
		0,4																													
			0,8																												
		0,2																													
			0,4																												
		0,8																													
			0,4																												
		0,8																													
			Finishing	RFX	TPGT 080202 RFX TPGT 080204 RFX	0,2																									
0,4																															
0,2																															
	0,4																														
0,8																															
	0,2																														
0,4																															
	0,8																														
0,4																															
	0,8																														

● = Euro stock  
 ○ = Japan stock

Pos. Inserts



# T TRIANGLE TYPE

## INSERTS FOR TURNING

11° Positive Inserts

60° Triangle Type

11° Relief  
With Insert Hole

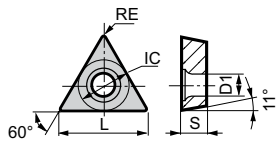

Dimensions (mm)				
TP	L	IC	S	D <sub>1</sub>
0802..	8,2	4,76	2,38	2,4
0902..	9,6	5,56	2,38	2,8
1102..	11,0	6,35	2,38	2,8
1103..	11,0	6,35	3,18	3,4
1603..	16,5	9,525	3,18	4,4



⇒ E20

- P** Steel
- M** Stainless Steel
- K** Cast Iron
- N** Non-Ferrous Metals
- S** Super Alloy
- H** Hardened Steel

# TPGT/-W

Carbide										Cermets		Carbide													
Coated										Coated	Uncoated	Uncoated													
P	P	M	M	K	H	S	P	P	K	S	N														
AC8015P	AC8020P	AC8025P	AC8035P	AC6020M	AC6030M	AC6040M	AC630M	AC4010K	AC4015K	AC420K	AC503U	AC5005S	AC5015S	AC5025S	AC1030U	AC530U	T1500Z	T2500Z	T3000Z	T1000A	T1500A	G10E	EH510	EH520	H1

### ● G-Class

Application	Shape	ISO Cat. No.	RE	AC8015P	AC8020P	AC8025P	AC8035P	AC6020M	AC6030M	AC6040M	AC630M	AC4010K	AC4015K	AC420K	AC503U	AC5005S	AC5015S	AC5025S	AC1030U	AC530U	T1500Z	T2500Z	T3000Z	T1000A	T1500A	G10E	EH510	EH520	H1	
Finishing	 L/RFY	TPGT 0802003 LFY	0,03																											
		TPGT 080201 LFY	0,1																											
		TPGT 080202 LFY	0,2																											
		TPGT 080204 LFY	0,4																											
		TPGT 090201 LFY	0,1																											
		TPGT 090202 LFY	0,2																											
		TPGT 090204 LFY	0,4																											
		TPGT 110202 LFY	0,2																											
		TPGT 110204 LFY	0,4																											
		TPGT 110208 LFY	0,8																											
		TPGT 1103003 LFY	0,03																											
		TPGT 110301 LFY	0,1																											
	TPGT 110302 LFY	0,2																												
	TPGT 110304 LFY	0,4																												
	TGPT 110308 LFY	0,8																												
	TPGT 160302 LFY	0,2																												
	TPGT 160304 LFY	0,4																												
	TPGT 160308 LFY	0,8																												
	For Aluminum	 L/RAY	TPGT 0802003 RFY	0,03																										
			TPGT 080201 RFY	0,1																										
			TPGT 080202 RFY	0,2																										
			TPGT 080204 RFY	0,4																										
			TPGT 090201 RFY	0,1																										
			TPGT 090202 RFY	0,2																										
TPGT 090204 RFY		0,4																												
TPGT 110202 RFY		0,2																												
TPGT 110204 RFY		0,4																												
TPGT 110208 RFY		0,8																												
TPGT 1103003 RFY		0,03																												
TPGT 110301 RFY		0,1																												
TPGT 110302 RFY	0,2																													
TPGT 110304 RFY	0,4																													
TPGT 110308 RFY	0,8																													
TPGT 160302 RFY	0,2																													
TPGT 160304 RFY	0,4																													
TPGT 160308 RFY	0,8																													
Light Cut		TPGW 080202	0,2																											
		TPGW 110302	0,2																											
		TPGW 110304	0,4																											
		TPGW 110308	0,8																											
		TPGW 160404	0,4																											

● = Euro stock  
○ = Japan stock

60° Triangle Type 11° Relief  
With Insert Hole

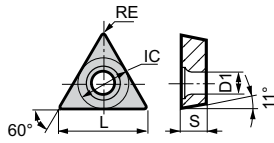

Dimensions (mm)					
TP	L	IC	S	D <sub>1</sub>	
0802..	8,2	4,76	2,38	2,4	
1103..	11,0	6,35	3,18	3,4	
1604..	16,5	9,525	4,76	4,4	



⇒ E20

- P Steel
- M Stainless Steel
- K Cast Iron
- N Non-Ferrous Metals
- S Super Alloy
- H Hardened Steel

### TPGT/-X

● G-Class Handed Chipbreaker

Application	Shape	ISO Cat. No.	RE	Carbide													Cermet		Carbide
				Coated													Coated	Uncoated	Uncoated
				P	M	K	H	S	P	T	P	K	S	N					
Finishing-Light Cutting	L/RW	TPGT 080202 LW	0,2																
		TPGT 080204 LW	0,4																
		TPGT 110302 LW	0,2																
		TPGT 110304 LW	0,4																
		TPGT 160402 LW	0,2																
		TPGT 160404 LW	0,4																
	L/RSD	TPGT 080202 RW	0,2																
		TPGT 080204 RW	0,4																
		TPGT 110302 RW	0,2																
		TPGT 110304 RW	0,4																
		TPGT 160404 RW	0,4																
		L/RSDW	TPGT 110302 LSD	0,2															
TPGT 110304 LSD	0,4																		
TPGT 110308 LSD	0,8																		
TPGT 160402 LSD	0,2																		
TPGT 160404 LSD	0,4																		
TPGT 160408 LSD	0,8																		
L/RSDW	TPGX 110304 L-SDW	0,4																	
	TPGX 110308 L-SDW	0,8																	
	TPGX 160404 L-SDW	0,4																	
	TPGX 160408 L-SDW	0,8																	
	TPGX 110304 R-SDW	0,4																	
	TPGX 110308 R-SDW	0,8																	
L/RSDW	TPGX 160404 R-SDW	0,4																	
	TPGX 160408 R-SDW	0,8																	

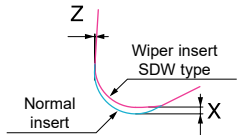
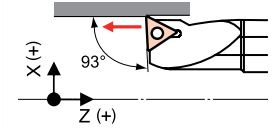

(Note) The cutting point position of the SDW type does not follow the ISO standard. Wenn using on a boring holder with a 93° approach angle, there is a need to revise the cutting point position (refer to right table) relative to using standard inserts.

RE	Compensation (mm)	
	X (Diam. change)	Z
0,4	+0,12 (Ø: +0,24)	-0,02
0,8	+0,12 (Ø: +0,24)	-0,02

- = Euro stock
- = Japan stock

Pos. Inserts





# T TRIANGLE TYPE

## INSERTS FOR TURNING

11° Positive Inserts

60° Triangle Type 11° Relief  
With Insert Hole

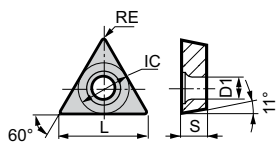

Dimensions (mm)					
TP	L	IC	S	D <sub>1</sub>	
0802..	8,2	4,76	2,38	2,4	
0902..	9,6	5,56	2,38	2,8	
1103..	11,0	6,35	3,18	3,4	
1603..	16,5	9,525	3,18	4,4	
1604..	16,5	9,525	4,76	4,4	



⇒ E20

- P Steel
- M Stainless Steel
- K Cast Iron
- N Non-Ferrous Metals
- S Super Alloy
- H Hardened Steel

## TPMT

Carbide											Cermets		Carbide												
Coated											Coated	Uncoated	Uncoated												
P	M	M	K	H	S	P	P	K	S	N															
AC8015P	AC8020P	AC8025P	AC8035P	AC6020M	AC6030M	AC6040M	AC630M	AC4010K	AC4015K	AC420K	AC503U	AC5005S	AC5015S	AC5025S	AC1030U	AC530U	T1500Z	T2500Z	T3000Z	T1000A	T1500A	G10E	EH510	EH520	H1

### ● M-Class

Application	Shape	ISO Cat. No.	RE	AC8015P	AC8020P	AC8025P	AC8035P	AC6020M	AC6030M	AC6040M	AC630M	AC4010K	AC4015K	AC420K	AC503U	AC5005S	AC5015S	AC5025S	AC1030U	AC530U	T1500Z	T2500Z	T3000Z	T1000A	T1500A	G10E	EH510	EH520	H1		
Finishing  NFB		TPMT 080202 NFB	0,2																												
		TPMT 080204 NFB	0,4																												
		TPMT 090202 NFB	0,2																												
		TPMT 090204 NFB	0,4																												
		TPMT 110302 NFB	0,2																												
		TPMT 110304 NFB	0,4																												
Light Cut  NLB		TPMT 160308 NFB	0,8																												
		TPMT 160304 NFB	0,4																												
		TPMT 160308 NFB	0,8																												
		TPMT 160404 NFB	0,4																												
		TPMT 160408 NFB	0,8																												
		TPMT 160404 NFB	0,4																												
Finishing  NFK		TPMT 160304 NLB	0,4																												
		TPMT 160308 NLB	0,8																												
		TPMT 160404 NLB	0,4																												
		TPMT 160408 NLB	0,8																												
		TPMT 110304 NFK	0,4																												
		TPMT 110308 NFK	0,8																												
Finishing  NLU		TPMT 160404 NFK	0,4																												
		TPMT 160408 NFK	0,8																												
		TPMT 080202 NLU	0,2																												
		TPMT 080204 NLU	0,4																												
		TPMT 090202 NLU	0,2																												
		TPMT 090204 NLU	0,4																												

● = Euro stock  
○ = Japan stock

**60° Triangle Type** 11° Relief  
With Insert Hole

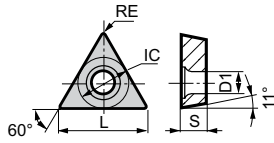

Dimensions (mm)					
TP	L	IC	S	D <sub>1</sub>	
0802..	8,2	4,76	2,38	2,4	
1103..	11,0	6,35	3,18	3,4	
1604..	16,5	9,525	4,76	4,4	



⇒ E20

- P Steel
- M Stainless Steel
- K Cast Iron
- N Non-Ferrous Metals
- S Super Alloy
- H Hardened Steel

### TPMT

● M-Class

Application	Shape	ISO Cat. No.	RE
Light Cut Depth of cut (mm) Feed rate (mm/rev)		TPMT 080202 NSU	0,2
		TPMT 080204 NSU	0,4
		TPMT 110302 NSU	0,2
		TPMT 110304 NSU	0,4
Light -Medium Cut Depth of cut (mm) Feed rate (mm/rev)		TPMT 110304 NGU	0,4
		TPMT 110308 NGU	0,8
		TPMT 160404 NGU	0,4
		TPMT 160408 NGU	0,8
Light -Medium Cut Depth of cut (mm) Feed rate (mm/rev)		TPMT 110304 NMU	0,4
		TPMT 110308 NMU	0,8
		TPMT 160404 NMU	0,4
		TPMT 160408 NMU	0,8

Carbide													Cermet		Carbide										
Coated													Coated	Uncoated	Uncoated										
P	M	K	H	S	P	M	P	K	S	N															
AC8015P	AC8020P	AC8025P	AC8035P	AC6020M	AC6030M	AC6040M	AC630M	AC4010K	AC4015K	AC420K	AC503U	AC5005S	AC5015S	AC5025S	AC1030U	AC530U	T1500Z	T2500Z	T3000Z	T1000A	T1500A	G10E	EH510	EH520	H1

### TPMT/H NSF

● M-Class

Application	Shape	ISO Cat. No.	RE
Light -Medium Cut Depth of cut (mm) Feed rate (mm/rev)		TPMH 110304 NSF	0,4
		TPMH 110308 NSF	0,8
		TPMT 160404 NSF	0,4
		TPMT 160408 NSF	0,8

Carbide													Cermet		Carbide										
Coated													Coated	Uncoated	Uncoated										
P	M	K	H	S	P	M	P	K	S	N															
AC8015P	AC8020P	AC8025P	AC8035P	AC6020M	AC6030M	AC6040M	AC630M	AC4010K	AC4015K	AC420K	AC503U	AC5005S	AC5015S	AC5025S	AC1030U	AC530U	T1500Z	T2500Z	T3000Z	T1000A	T1500A	G10E	EH510	EH520	H1

- = Euro stock
- = Japan stock

- Pos. Inserts
- C
  - D
  - K
  - R
  - S
  - T
  - V
  - W

# T TRIANGLE TYPE

## INSERTS FOR TURNING

5°/11° Positive Inserts

60° Triangle Type 5°/11° Relief Without Insert Hole

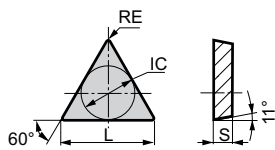

Dimensions (mm)					
TP/TB	L	IC	S	D <sub>1</sub>	
0601..	6,9	3,97	1,59	-	
0902..	9,6	5,56	2,38	-	
1103..	11,0	6,35	3,18	-	
1603..	16,5	9,525	3,18	-	
2204..	22,0	12,7	4,75	-	



- P Steel
- M Stainless Steel
- K Cast Iron
- N Non-Ferrous Metals
- S Super Alloy
- H Hardened Steel

## TPGR

Application	Shape	ISO Cat. No.	RE	Carbide													Cermet		Carbide																
				Coated													Coated	Uncoated	Uncoated																
				P	M	F	K	H	S	P	M	P	K	S	N	P	K	S	N																
Finishing-Light Cut		TPGR 090202 LW TPGR 090204 LW TPGR 090208 LW	0,2	<span style="background-color: #000080; color: white;">AC8015P</span>	<span style="background-color: #000080; color: white;">AC8020P</span>	<span style="background-color: #000080; color: white;">AC8025P</span>	<span style="background-color: #000080; color: white;">AC8035P</span>	<span style="background-color: #800000; color: white;">AC6020M</span>	<span style="background-color: #800000; color: white;">AC6030M</span>	<span style="background-color: #800000; color: white;">AC6040M</span>	<span style="background-color: #000080; color: white;">AC630M</span>	<span style="background-color: #800080; color: white;">AC4010K</span>	<span style="background-color: #800080; color: white;">AC4015K</span>	<span style="background-color: #800080; color: white;">AC420K</span>	<span style="background-color: #800080; color: white;">AC503U</span>	<span style="background-color: #800080; color: white;">AC5005S</span>	<span style="background-color: #800080; color: white;">AC5015S</span>	<span style="background-color: #800080; color: white;">AC5025S</span>	<span style="background-color: #000080; color: white;">AC1030U</span>	<span style="background-color: #000080; color: white;">AC530U</span>	<span style="background-color: #000080; color: white;">T1500Z</span>	<span style="background-color: #000080; color: white;">T2500Z</span>	<span style="background-color: #000080; color: white;">T3000Z</span>	<span style="background-color: #000080; color: white;">T1000A</span>	<span style="background-color: #000080; color: white;">T1500A</span>	<span style="background-color: #800080; color: white;">G10E</span>	<span style="background-color: #800080; color: white;">EH510</span>	<span style="background-color: #800080; color: white;">EH520</span>	<span style="background-color: #800080; color: white;">H1</span>						
			0,4																																
			0,8																																
			0,2																																
			0,4																																
			0,8																																
			0,2																																
			0,4																																
			0,8																																
			0,2																																
			0,4																																
			0,8																																

### ● G-Class Handed Chipbreaker

Application	Shape	ISO Cat. No.	RE		
Finishing-Light Cut		TPGR 090202 LW TPGR 090204 LW TPGR 090208 LW	0,2		
			0,4		
			0,8		
		TPGR 110302 LW TPGR 110304 LW TPGR 110308 LW	0,2		
			0,4		
			0,8		
		TPGR 160302 LW TPGR 160304 LW TPGR 160308 LW	0,2		
			0,4		
			0,8		
		Finishing-Light Cut		TPGR 090202 RW TPGR 090204 RW TPGR 090208 RW	0,2
					0,4
					0,8
TPGR 110302 RW TPGR 110304 RW	0,2				
	0,4				
	0,8				
TPGR 160302 RW TPGR 160304 RW TPGR 160308 RW	0,2				
	0,4				
	0,8				

## TBG

Application	Shape	ISO Cat. No.	RE	Carbide													Cermet		Carbide										
				Coated													Coated	Uncoated	Uncoated										
				P	M	F	K	H	S	P	M	P	K	S	N	P	K	S	N										
Finishing - Light-Cut		TBGN 060104	0,4	<span style="background-color: #000080; color: white;">AC8015P</span>	<span style="background-color: #000080; color: white;">AC8020P</span>	<span style="background-color: #000080; color: white;">AC8025P</span>	<span style="background-color: #000080; color: white;">AC8035P</span>	<span style="background-color: #800000; color: white;">AC6020M</span>	<span style="background-color: #800000; color: white;">AC6030M</span>	<span style="background-color: #800000; color: white;">AC6040M</span>	<span style="background-color: #000080; color: white;">AC630M</span>	<span style="background-color: #800080; color: white;">AC4010K</span>	<span style="background-color: #800080; color: white;">AC4015K</span>	<span style="background-color: #800080; color: white;">AC420K</span>	<span style="background-color: #800080; color: white;">AC503U</span>	<span style="background-color: #800080; color: white;">AC5005S</span>	<span style="background-color: #800080; color: white;">AC5015S</span>	<span style="background-color: #800080; color: white;">AC5025S</span>	<span style="background-color: #000080; color: white;">AC1030U</span>	<span style="background-color: #000080; color: white;">AC530U</span>	<span style="background-color: #000080; color: white;">T1500Z</span>	<span style="background-color: #000080; color: white;">T2500Z</span>	<span style="background-color: #000080; color: white;">T3000Z</span>	<span style="background-color: #000080; color: white;">T1000A</span>	<span style="background-color: #000080; color: white;">T1500A</span>	<span style="background-color: #800080; color: white;">G10E</span>	<span style="background-color: #800080; color: white;">EH510</span>	<span style="background-color: #800080; color: white;">EH520</span>	<span style="background-color: #800080; color: white;">H1</span>
			0,4																										

### ● G-Class No Chipbreaker/ Handed Chipbreaker

Application	Shape	ISO Cat. No.	RE
Finishing - Light-Cut		TBGN 060104	0,4
		TBGR 060104 LW	0,4

## TPGN

Application	Shape	ISO Cat. No.	RE	Carbide													Cermet		Carbide															
				Coated													Coated	Uncoated	Uncoated															
				P	M	F	K	H	S	P	M	P	K	S	N	P	K	S	N															
Light Cut		TPGN 090202 TPGN 090208	0,2	<span style="background-color: #000080; color: white;">AC8015P</span>	<span style="background-color: #000080; color: white;">AC8020P</span>	<span style="background-color: #000080; color: white;">AC8025P</span>	<span style="background-color: #000080; color: white;">AC8035P</span>	<span style="background-color: #800000; color: white;">AC6020M</span>	<span style="background-color: #800000; color: white;">AC6030M</span>	<span style="background-color: #800000; color: white;">AC6040M</span>	<span style="background-color: #000080; color: white;">AC630M</span>	<span style="background-color: #800080; color: white;">AC4010K</span>	<span style="background-color: #800080; color: white;">AC4015K</span>	<span style="background-color: #800080; color: white;">AC420K</span>	<span style="background-color: #800080; color: white;">AC503U</span>	<span style="background-color: #800080; color: white;">AC5005S</span>	<span style="background-color: #800080; color: white;">AC5015S</span>	<span style="background-color: #800080; color: white;">AC5025S</span>	<span style="background-color: #000080; color: white;">AC1030U</span>	<span style="background-color: #000080; color: white;">AC530U</span>	<span style="background-color: #000080; color: white;">T1500Z</span>	<span style="background-color: #000080; color: white;">T2500Z</span>	<span style="background-color: #000080; color: white;">T3000Z</span>	<span style="background-color: #000080; color: white;">T1000A</span>	<span style="background-color: #000080; color: white;">T1500A</span>	<span style="background-color: #800080; color: white;">G10E</span>	<span style="background-color: #800080; color: white;">EH510</span>	<span style="background-color: #800080; color: white;">EH520</span>	<span style="background-color: #800080; color: white;">H1</span>					
			0,8																															
			0,2																															
		0,4																																
		0,8																																
		0,2																																
		0,4																																
		0,8																																
		1,2																																
		0,4																																

### ● G-Class No Chipbreaker

Application	Shape	ISO Cat. No.	RE
Light Cut		TPGN 090202 TPGN 090208	0,2
			0,8
			0,2
		TPGN 110302 TPGN 110304 TPGN 110308	0,2
			0,4
			0,8
		TPGN 160302 TPGN 160304 TPGN 160308 TPGN 160312 TPGN 220404	0,2
			0,4
			0,8

- = Euro stock
- = Japan stock



# DIAMOND TYPE

## INSERTS FOR TURNING

### 5° Positive Inserts

35° Diamond Type

5° Relief  
With Insert Hole

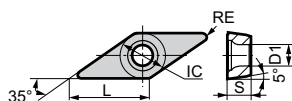

Dimensions (mm)				
VB	L	IC	S	D <sub>1</sub>
1102..	11,0	6,35	2,38	2,38
1103..	11,1	6,35	3,18	2,8
1604..	16,6	9,525	4,76	4,4



⇒ D38

⇒ E21-22

- P** Steel
- M** Stainless Steel
- K** Cast Iron
- N** Non-Ferrous Metals
- S** Super Alloy
- H** Hardened Steel

## VBMT/-W

Carbide										Cermets		Carbide		
Coated										Coated	Uncoated	Uncoated		
P	P	M	M	K	H	S	P	P	K	S	N			

### ● M-Class

Application	Shape	ISO Cat. No.	RE	AC8015P	AC8020P	AC8025P	AC8035P	AC6020M	AC6030M	AC6040M	AC630M	AC4010K	AC4015K	AC420K	AC503U	AC5005S	AC5015S	AC5025S	AC1030U	AC530U	T1500Z	T2500Z	T3000Z	T1000A	T1500A	G10E	EH510	EH520	H1			
Finishing Depth of cut (mm) Feed rate (mm/rev)	 <b>NFB</b>	VBMT 110302 NFB	0,2																		○	●	○	○	○							
		VBMT 110304 NFB	0,4																			○	●	○	○	○						
		VBMT 110308 NFB	0,8																			○	●	○	○	○						
		VBMT 160404 NFB	0,4																			○	●	○	○	○						
		VBMT 160408 NFB	0,8																			○	●	○	○	○						
Finishing Depth of cut (mm) Feed rate (mm/rev)	 <b>NFP</b>	VBMT 110202 NFP	0,2																			●										
		VBMT 110204 NFP	0,4																													
		VBMT 160404 NFP	0,4																													
		VBMT 160408 NFP	0,8																													
Finishing Depth of cut (mm) Feed rate (mm/rev)	 <b>NLU</b>	VBMT 110302 NLU	0,2																			○	○	○	○	○						
		VBMT 110304 NLU	0,4	○	●	●																	○	○	○	○	○					
		VBMT 110308 NLU	0,8	○	○	○																	○	○	○	○	○					
		VBMT 160404 NLU	0,4	●	○	○																	○	○	○	○	○					
		VBMT 160408 NLU	0,8	●	●	●																	○	○	○	○	○					
Light Cut Depth of cut (mm) Feed rate (mm/rev)	 <b>NLB</b>	VBMT 110302 NLB	0,2		○	○	○	○	○	○	○												○	○	○	○	○					
		VBMT 110304 NLB	0,4		○	○	○	○	○	○	○													○	○	○	○	○				
		VBMT 110308 NLB	0,8		○	○	○	○	○	○	○													○	○	○	○	○				
		VBMT 160404 NLB	0,4		○	○	○	○	○	○	○													○	○	○	○	○				
		VBMT 160408 NLB	0,8		○	○	○	○	○	○	○													○	○	○	○	○				
VBMT 160412 NLB	1,2		○	○	○	○	○	○	○													○	○	○	○	○						
Light Cut Depth of cut (mm) Feed rate (mm/rev)	 <b>NSU</b>	VBMT 110204 NSU	0,4	●	●	●																○										
		VBMT 110208 NSU	0,8	●	●	●																										
		VBMT 110302 NSU	0,2																				○									
		VBMT 110304 NSU	0,4	●	●	●																		○								
		VBMT 110308 NSU	0,8	●	●	●																										
Light Cut Depth of cut (mm) Feed rate (mm/rev)	 <b>NSK</b>	VBMT 160404 NSU	0,4	●	●	●																○	○	○	○	○						
		VBMT 160408 NSU	0,8	●	●	●																	○	○	○	○	○					
		VBMT 160412 NSU	1,2	○	○	○																	○	○	○	○	○					
Light - Medium Cut Depth of cut (mm) Feed rate (mm/rev)	 <b>NGU</b>	VBMT 110304 NGU	0,4	○	○	○																	○	○	○	○	○					
		VBMT 110308 NGU	0,8	●	○	○																		○	○	○	○	○				
		VBMT 160404 NGU	0,4	●	●	●																		○	○	○	○	○				
		VBMT 160408 NGU	0,8	●	●	●																		○	○	○	○	○				
Light - Medium Cut Depth of cut (mm) Feed rate (mm/rev)	 <b>NMU</b>	VBMT 160408 NMU	0,8	●																												
Light Cut		VBMW 160404	0,4																													
		VBMW 160408	0,8																													

● = Euro stock  
○ = Japan stock

**35° Diamond Type** 5° Relief  
With Insert Hole

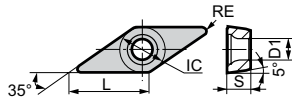

Dimensions (mm)					
VB	L	IC	S	D <sub>1</sub>	
1103..	11,1	6,35	3,18	2,8	
1604..	16,6	9,525	4,76	4,4	



- P Steel
- M Stainless Steel
- K Cast Iron
- N Non-Ferrous Metals
- S Super Alloy
- H Hardened Steel

# VBGT

● G-Class

Application	Shape	ISO Cat. No.	RE
Finishing	 <b>L/RFX</b>	VBGT 110301 LFX	0,1
		VBGT 110302 LFX	0,2
		VBGT 110304 LFX	0,4
		VBGT 160402 LFX	0,2
	 Depth of cut (mm) vs Feed rate (mm/rev)	VBGT 160404 LFX	0,4
		VBGT 110301 RFX	0,1
		VBGT 110302 RFX	0,2
		VBGT 110304 RFX	0,4
Finishing	 <b>L/RFY</b>	VBGT 110303 LFYS	0,03
		VBGT 110301 LFYS	0,1
		VBGT 110302 LFYS	0,2
		VBGT 110304 LFYS	0,4
	 Depth of cut (mm) vs Feed rate (mm/rev)	VBGT 110308 LFYS	0,8
		VBGT 110303 RFYS	0,03
		VBGT 110301 RFYS	0,1
		VBGT 110302 RFYS	0,2
Finishing	 <b>L/RFY</b>	VBGT 110304 RFYS	0,4
		VBGT 110308 RFYS	0,8
		VBGT 110301 LFY	0,1
		VBGT 110302 LFY	0,2
	 Depth of cut (mm) vs Feed rate (mm/rev)	VBGT 110304 LFY	0,4
		VBGT 110301 RFY	0,1
		VBGT 110302 RFY	0,2
		VBGT 110304 RFY	0,4
Light Cut	 <b>NSI</b>	VBGT 110301M NSI	<0,1
		VBGT 110302M NSI	<0,2
		VBGT 110304M NSI	<0,4
		VBGT 110308M NSI	<0,8
	 Depth of cut (mm) vs Feed rate (mm/rev)	VBGT 160401M NSI	<0,1
		VBGT 160402M NSI	<0,2
		VBGT 160404M NSI	<0,4
		VBGT 160408M NSI	<0,8
For Aluminum	 <b>L/RAY</b>	VBGT 110301 LAY	0,1
		VBGT 110302 LAY	0,2
		VBGT 110304 LAY	0,4
		VBGT 160402 LAY	0,2
	 Depth of cut (mm) vs Feed rate (mm/rev)	VBGT 160404 LAY	0,4
		VBGT 110301 RAY	0,1
		VBGT 110302 RAY	0,2
		VBGT 110304 RAY	0,4
 Depth of cut (mm) vs Feed rate (mm/rev)	VBGT 160402 RAY	0,2	
	VBGT 160404 RAY	0,4	

Carbide													Cermet		Carbide											
Coated													Coated	Uncoated	Uncoated											
P	M	K	N	S	H	P	M	P	K	S	N	P	K	S	N											
AC8015P	AC8020P	AC8025P	AC8035P	AC6020M	AC6030M	AC6040M	AC630M	AC4010K	AC4015K	AC420K	AC503J	AC5005S	AC5015S	AC5025S	AC1030U	AC530U	T1500Z	T2500Z	T3000Z	T1000A	T1500A	G10E	EH510	EH620	H1	
●	●	●	●	●	●	●	●	●	●	●	●	●	●	●	●	●	○	○	○	○	○	○	○	○	○	○

● = Euro stock  
 ○ = Japan stock

- Pos. Inserts
- - 
  - 
  - 
  - 
  - 
  - 
  -



# DIAMOND TYPE INSERTS FOR TURNING

## 7° Positive Inserts

35° Diamond Type

7° Relief  
With Insert Hole

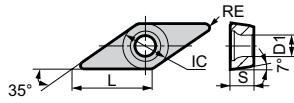

Dimensions (mm)				
VC	L	IC	S	D <sub>1</sub>
0802..	8,3	4,76	2,38	2,3
1103..	11,1	6,35	3,18	2,8
1604..	16,6	9,525	4,76	4,4
2205..	20,2	12,7	5,56	5,5



⇒ D39

"S...- SV...C" - Type  
(⇒ Stock in Japan)

- P** Steel
- M** Stainless Steel
- K** Cast Iron
- N** Non-Ferrous Metals
- S** Super Alloy
- H** Hardened Steel

# VCGT

Carbide										Cermets		Carbide		
Coated										Coated	Uncoated	Uncoated		
P	P	M	M	K	H	S	P	P	K	S	N			

### ● G-Class

Application	Shape	ISO Cat. No.	RE	AC8015P	AC8020P	AC8025P	AC8035P	AC6020M	AC6030M	AC6040M	AC630M	AC4010K	AC4015K	AC420K	AC503U	AC5005S	AC5015S	AC5025S	AC1030U	AC530U	T1500Z	T2500Z	T3000Z	T1000A	T1500A	G10E	EH510	EH520	H1	
Finishing	NFC	VCGT 080204M NFC	<0,4																											
		VCGT 110301M NFC	<0,1																											
		VCGT 110302M NFC	<0,2																											
		VCGT 110304M NFC	<0,4																											
Finishing	L/RFX	VCGT 110301 LFX	0,1																											
		VCGT 110302 LFX	0,2																											
		VCGT 110304 LFX	0,4																											
Finishing	L/RFY	VCGT 110301 RFX	0,1																											
		VCGT 110302 RFX	0,2																											
		VCGT 110304 RFX	0,4																											
Finishing	L/RFY	VCGT 110301 LFY	0,1																											
		VCGT 110302 LFY	0,2																											
		VCGT 110304 LFY	0,4																											
Light Cut	NAG	VCGT 110302 NAG	0,2																											
		VCGT 110304 NAG	0,4																											
		VCGT 160408 NAG	0,8																											
Light Cut	NSI	VCGT 220530 NAG	3,0																											
		VCGT 110301M NSI	<0,1																											
		VCGT 110302M NSI	<0,2																											
Light Cut	NSI	VCGT 110304M NSI	<0,4																											
		VCGT 110308M NSI	<0,8																											
		VCGT 160401M NSI	<0,1																											
		VCGT 160402M NSI	<0,2																											
		VCGT 160404M NSI	<0,4																											
VCGT 160408M NSI	<0,8																													

● = Euro stock  
○ = Japan stock

**35° Diamond Type** 7° Relief  
With Insert Hole

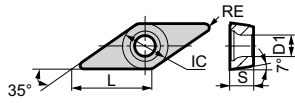

Dimensions (mm)					
VC	L	IC	S	D <sub>1</sub>	
0802..	8,3	4,76	2,38	2,3	
1103..	11,1	6,35	3,18	2,8	
1604..	16,6	9,525	4,76	4,4	



⇒ D39

"S...- SV...C" - Type  
 (⇒ Stock in Japan)

- P Steel
- M Stainless Steel
- K Cast Iron
- N Non-Ferrous Metals
- S Super Alloy
- H Hardened Steel

### VCMT

● M-Class

Application	Shape	ISO Cat. No.	RE	Carbide										Cermets		Carbide	
				Coated										Coated	Uncoated	Uncoated	
				P	M	M	K	H	S	P		P	K	S	N		
Finishing	 <b>NFB</b>	VCMT 080202 NFB	0,2														
		VCMT 080204 NFB	0,4														
		VCMT 160404 NFB	0,4														
VCMT 160408 NFB	0,8																
Finishing	 <b>NLU</b>	VCMT 160404 NLU	0,4	○	○	○											
		VCMT 160408 NLU	0,8	○	○	○											
Light Cut	 <b>NLB</b>	VCMT 080202 NLB	0,2	○	○	○	○	○									
		VCMT 080204 NLB	0,4	○	○	○	○	○									
		VCMT 160404 NLB	0,4	○	○	○	○	○									
VCMT 160408 NLB	0,8	○	○	○	○	○											
Light Cut	 <b>NSU</b>	VCMT 080204 NSU	0,4			○	○	●	○			○					
		VCMT 110302 NSU	0,2			○	○	●	○			○					
		VCMT 110304 NSU	0,4			○	○	●	○			○					
VCMT 110308 NSU	0,8			○	○	●	○			○							
VCMT 160404 NSU	0,4	●	●	●	●	●			●	●	●						
VCMT 160408 NSU	0,8	●	●	●	●	●			○	○	○						
Light Cut	 <b>NSK</b>	VCMT 160404 NSK	0,4	●	●	●						●					
		VCMT 160408 NSK	0,8	●	●	●							●				
Light - Medium Cut	 <b>NGU</b>	VCMT 160404 NGU <span style="color: yellow;">New</span>	0,4	●	●	○	○	○	○	●							
		VCMT 160408 NGU <span style="color: yellow;">New</span>	0,8	●	●	○	○	○	○								

● = Euro stock  
 ○ = Japan stock

Pos. Inserts



# W TRIGON TYPE

## INSERTS FOR TURNING

### 5° Positive Inserts



⇒ E23

- P** Steel
- M** Stainless Steel
- K** Cast Iron
- N** Non-Ferrous Metals
- S** Super Alloy
- H** Hardened Steel

**80° Trigon Type**      5° Relief  
With Insert Hole

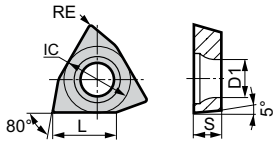

Dimensions (mm)				
WB	L	IC	S	D <sub>1</sub>
0601..	3,2	3,97	1,59	2,2
0802..	4,6	4,76	2,38	2,4

# WBGT

Carbide											Cermets		Carbide												
Coated											Coated	Uncoated	Uncoated												
P	M	M	M	K	H	S	P	P	K	S	N														
AC8015P	AC8020P	AC8025P	AC8035P	AC6020M	AC6030M	AC6040M	AC630M	AC4010K	AC4015K	AC420K	AC503U	AC5005S	AC5015S	AC5025S	AC1030U	AC530U	T1500Z	T2500Z	T3000Z	T1000A	T1500A	G10E	EH510	EH520	H1

### ● G-Class Handed Chipbreaker

Application	Shape	ISO Cat. No.	RE	AC8015P	AC8020P	AC8025P	AC8035P	AC6020M	AC6030M	AC6040M	AC630M	AC4010K	AC4015K	AC420K	AC503U	AC5005S	AC5015S	AC5025S	AC1030U	AC530U	T1500Z	T2500Z	T3000Z	T1000A	T1500A	G10E	EH510	EH520	H1	
Finishing Depth of cut (mm) Feed rate (mm/rev)	 <b>L/RFW</b>	WBGT 060102 LFW WBGT 060104 LFW	0,2 0,4																											
		WBGT 080202 LFW WBGT 080204 LFW	0,2 0,4																											
		WBGT 060102 RFW WBGT 060104 RFW	0,2 0,4																											
		WBGT 080202 RFW WBGT 080204 RFW	0,2 0,4																											
		WBGT 060102 LFX WBGT 060104 LFX	0,2 0,4																											
		WBGT 080202 LFX WBGT 080204 LFX	0,2 0,4																											
Finishing Depth of cut (mm) Feed rate (mm/rev)	 <b>L/RFX</b>	WBGT 060102 RFX WBGT 060104 RFX	0,2 0,4																											
		WBGT 080202 RFX WBGT 080204 RFX	0,2 0,4																											
		WBGT 0601003 LFY	0,03																											
		WBGT 060101 LFY WBGT 060102 LFY WBGT 060104 LFY	0,1 0,2 0,4																											
		WBGT 080201 LFY WBGT 080202 LFY WBGT 080204 LFY	0,1 0,2 0,4																											
		WBGT 060101 RFY WBGT 060102 RFY WBGT 060104 RFY	0,1 0,2 0,4																											
Finishing ~ Light Cut Depth of cut (mm) Feed rate (mm/rev)	 <b>L/RW</b>	WBGT 080201 RFY WBGT 080202 RFY WBGT 080204 RFY	0,1 0,2 0,4																											
		WBGT 060102 LW WBGT 060104 LW	0,2 0,4																											
		WBGT 060102 RW WBGT 060104 RW	0,2 0,4																											
		WBGT 060102 LW WBGT 060104 LW	0,2 0,4																											
		WBGT 060102 RW WBGT 060104 RW	0,2 0,4																											
		WBGT 060102 RW WBGT 060104 RW	0,2 0,4																											

● = Euro stock  
○ = Japan stock





# External Holders

# D



**D1–D46**



External Holders

Selection	Turning Holder Series .....	D2–7
ISO	Turning Holder Identification Table .....	D8
	Calculation of The Cutting Edge Position .....	D9
T-REX Tool Holders	SumiTura T-REX Tool Holders .....	D10–11
For High Performance Turning	<b>D Type Double Clamp Holders</b>	
	DC Type Holders .....	D12
	DD Type Holders .....	D13
	DS Type Holders .....	D14
	DT Type Holders .....	D15
	DV Type Holders .....	D16
	DW Type Holders .....	D17
For General Turning	<b>P Type Lever Lock and M Type Top &amp; Hole Clamp Holders</b>	
	PC Type Holders .....	D18
	PD Type Holders .....	D19
	PS Type Holders .....	D20–21
	PT / MT Type Holders .....	D22–23
	PW / MW Type Holders .....	D24
For Solid CBN Inserts	C Type Clamp On Holders .....	D25–26
	X Type Dimple Lock Holders .....	D27
Selection	<b>Mini Holders Series</b> .....	D28–29
Special for Back Facing	SBT Type Mini Holders .....	D30
Small Product Turning	PC / SC Type Mini Holders .....	D31
	PD / SD Type Mini Holders .....	D32–33
	PR Type Holders .....	D34
	SR Type Holders .....	D35
	SS Type Mini Holders .....	D36
	ST Type Mini Holders .....	D37
	SV Type Copying Holders .....	D38–39
For High Performance Turning	<b>Polygon-Shank Holders</b> .....	D40
	<b>D Type Double Clamp Holders</b>	
	PSC**DC Type Holders .....	D41
	PSC**DD Type Holders .....	D41
	PSC**DS Type Holders .....	D41
	PSC**DT Type Holders .....	D42
	PSC**DW Type Holders .....	D42
For General Turning	<b>S Type Screw Clamp</b>	
	PSC**SC Type Holders .....	D43
	PSC**SD Type Holders .....	D43
	PSC**SS Type Holders .....	D43
	PSC**ST Type Holders .....	D44
	PSC**SV Type Holders .....	D44–45



# External Tool Holder Series

According to Applications

External Holders

Application	For Neg. Inserts	For Pos. Inserts	Special Type for Hardened Steel
General Turning	<b>P Type Lever Lock Type</b>  ⇨ D18–D22	<b>P Type Lever Lock Type</b>  ⇨ D31, D32	<b>D Type Double Lock Type</b>  ⇨ D12–D17 ⇨ D41–D42
	<b>M Type Double Lock Type</b>  ⇨ D23–D24	<b>S Type Screw On Type</b>  D31–D33 ⇨ D35–D37 ⇨ D43–D45	<b>C Type Top Clamp Type</b>  ⇨ D25–D26
Copying	<b>T-REX</b>  ⇨ D10–D11	<b>S Type Screw On Type</b>  ⇨ D38–D39 ⇨ D43–D45	<b>D Type Double Lock Type</b>  ⇨ D13, D16 ⇨ D41
	<b>GNDS, GNDM, GNDMS Type General Grooving</b>  ⇨ F18, F22, F24 ⇨ F46–F49	<b>GNDL, GNDLS Type Deep Grooving</b>  ⇨ F18, F28 ⇨ F46–F49	<b>GNDF, GNDFS Type Axial Grooving</b>  ⇨ F34, F36 ⇨ F46–F49
Parting-Off Grooving	<b>SCT and GWC Type</b>  ⇨ F50–F54 ⇨ F51	<b>Sumi Grip and Sumi Grip Jr.</b>  ⇨ F55–F60	<b>GWB Type Hard Grooving</b>  ⇨ M54 ⇨ M55
	<b>SSTE and SSTI Type</b> Pitch { 0,5–3 mm / 48–8 Threads/inch }  ⇨ F62–F69	<b>THE Type</b> Pitch { 0,8–3 mm / 24–10 Threads/inch }  ⇨ Stock in Jp.	<b>BNGG-TT Type Hard Threading</b> Pitch 1–3 mm  ⇨ M56

Available in Polygon-Shank-Design

## External Turning

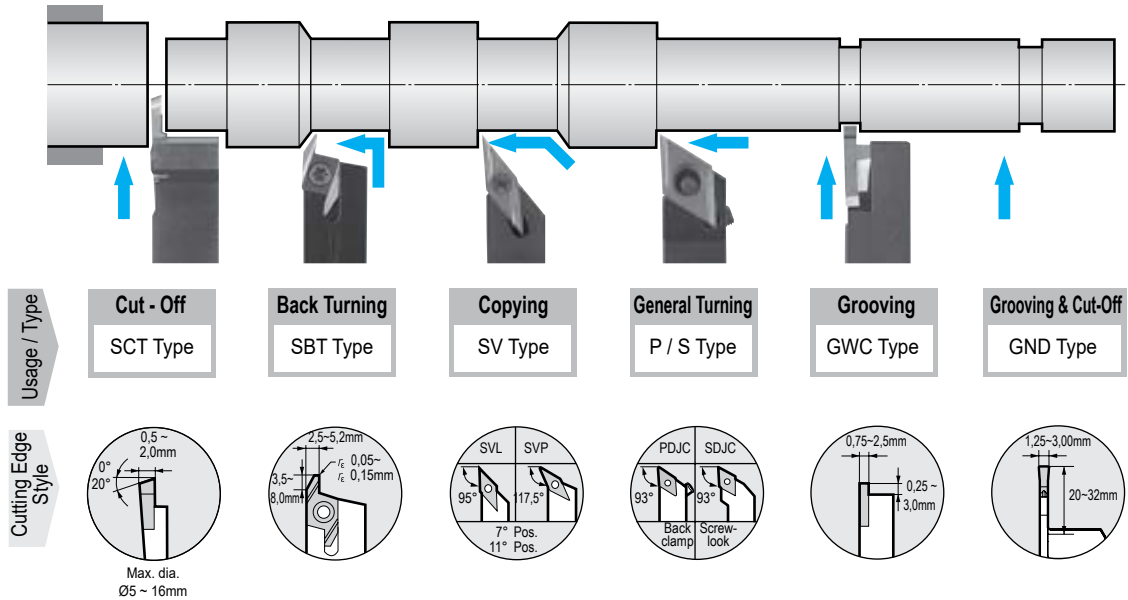

## Holder Selection for Autolathe

	Offset - 0 mm Type Holders	Offset - 0,5 mm Type Holders
Tooling		
Features	Program correction is not necessary.	The position of cutting edge can be put in near guide bush through a program correction.
Holder Types	SDJC-X, SDAC-X SDLC-X, SCAC-X SVJC-X (⇒ Stock in Japan)	PDJC, SDJC, SDAC PCLC, SCAC STAC, SVLC



# External Tool Holder Series

Lever Lock System



Double Lock (D)

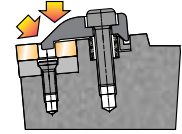

D Type "Double Clamp" Holders for high performance machining

## TOOLING SELECTION

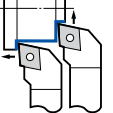
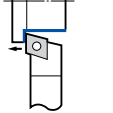
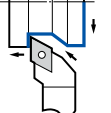
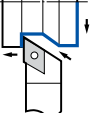
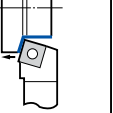
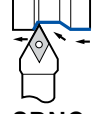
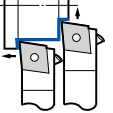
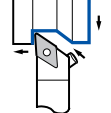
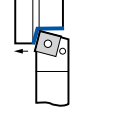
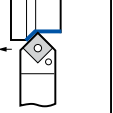
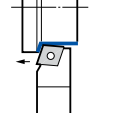
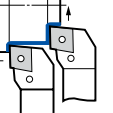
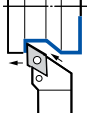
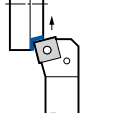
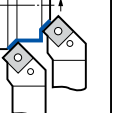
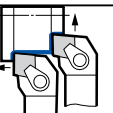
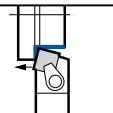
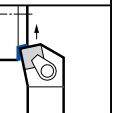
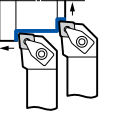
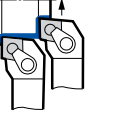
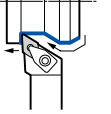
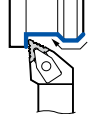
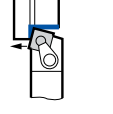
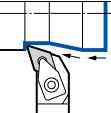
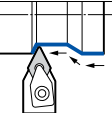
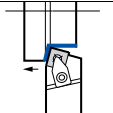
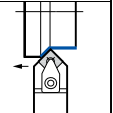
Application		General Turning & Facing	General Turning & Copying		General Turning			
			80° Diamond Type	55° Diamond Type		T-REX 55°	90° Square Type	
Insert Type System		80° Diamond Type		55° Diamond Type	T-REX 55°	90° Square Type		
Screw Lock System	S Type Mini Holder	 <b>SCLC</b> ⇨ D31	 <b>SCAC</b> ⇨ D31	 <b>SDJC</b> ⇨ D32	 <b>SDAC</b> ⇨ D33	—	 <b>SSBC</b> ⇨ D36	
		—	—	 <b>SDNC</b> ⇨ D33	—	—	—	
Lever Lock System	P Type (* Side Lever Lock Type)	 <b>PCLC</b> (*) ⇨ D31	—	 <b>PDJC</b> (*) ⇨ D32	—	—	 <b>PSBN</b> ⇨ D20	 <b>PSDN</b> ⇨ D20
		 <b>PCBN</b> ⇨ D18	 <b>PCLN</b> ⇨ D18	 <b>PDJN</b> ⇨ D19	—	—	 <b>PSKN</b> ⇨ D21	 <b>PSSN</b> ⇨ D21
Top-On Clamp System	C & M Type	 <b>CCLN</b> ⇨ D25	—	—	—	—	 <b>CSBN</b> ⇨ D25	 <b>CSKN</b> ⇨ D25
Double Lock (D) Dimple Lock (X)	D & X Type	 <b>DCLN</b> ⇨ D12	 <b>XCLN</b> ⇨ D27	 <b>DDJN</b> ⇨ D13	—	 <b>DTR</b> ⇨ D11	 <b>XSBN</b> ⇨ D27	—
		—	—	 <b>DDHN</b> ⇨ D13	 <b>DDNN</b> ⇨ D13	—	 <b>DSBN</b> ⇨ D14	 <b>DSDN</b> ⇨ D14

Top-On Clamp System



Screw Lock System

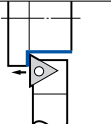
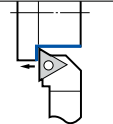
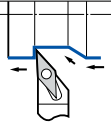
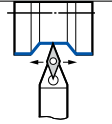
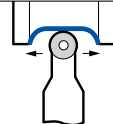
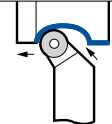
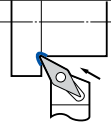
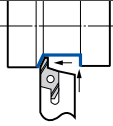
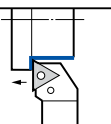
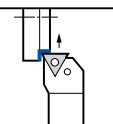
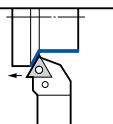
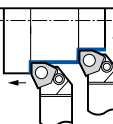
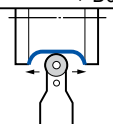
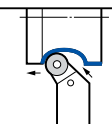
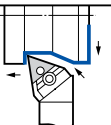
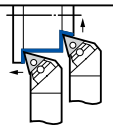
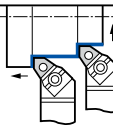
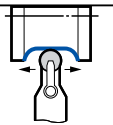
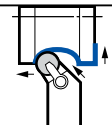
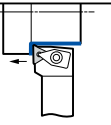
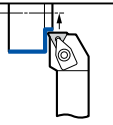
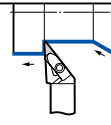
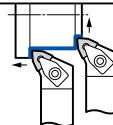
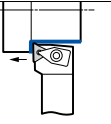
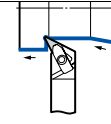
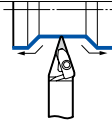

## TOOLING SELECTION

Application		General Turning			Copying		General Turning	Special Turning	
Insert Type		60° Triangle Type			35° Diamond Type		80° Trigon Type	Round and Special Purpose Inserts	
System									
Screw Lock System	S Type Mini Holder	 <b>STAC</b> ⇨ D37	 <b>STGC</b> ⇨ D37	—	 <b>SVJB</b> ⇨ D38 <b>SVLC</b> ⇨ D39	 <b>SVVB</b> ⇨ D38	—	 <b>SRDC</b> ⇨ D35	 <b>SRSC</b> ⇨ D35
		—	—	—	 <b>SVPB</b> ⇨ D38 <b>SVPC</b> ⇨ D39	—	—	 <b>SBT</b> ⇨ D30	—
Lever Lock System	P Type	 <b>PTGN</b> ⇨ D22	 <b>PTFN</b> ⇨ D22	 <b>PTTN</b> ⇨ D22	—	—	 <b>PWLN</b> ⇨ D24	 <b>PRDC</b> ⇨ D34	 <b>PRGC</b> ⇨ D34
		—	—	—	—	—	—	—	—
Top-On Clamp System	C & M Type	 <b>MTJN</b> ⇨ D23	 <b>MTXN</b> ⇨ D23	—	—	—	 <b>MWLN</b> ⇨ D24	 <b>CRDN</b> ⇨ D26	 <b>CRSN</b> ⇨ D26
		 <b>DTJN</b> ⇨ D15	 <b>DTFN</b> ⇨ D15	—	 <b>DVJN</b> ⇨ D16	—	 <b>DWLN</b> ⇨ D17	—	—
Double Lock (D) Dimple Lock (X)	D & X Type	 <b>DTGN</b> ⇨ D15	—	—	 <b>DVQN</b> ⇨ D16	 <b>DVVN</b> ⇨ D16	—	—	—
		—	—	—	—	—	—	—	—

# External Tool Holder Series



Polygon - Shank Holder - Produced According to ISO 26623-1



Negative Insert Type

## TOOLING SELECTION

Application			General Turning & Facing		General Turning & Copying			General Turning	
Insert Type System			80° Diamond Type		55° Diamond Type		T-REX 55°	90° Square Type	
Screw Lock System	S Type Mini Holder		<b>SCLC</b> ⇒ D43	—	<b>SDJC</b> ⇒ D43	—	—	—	<b>SSBC</b> ⇒ D43
			—	—	<b>SDHC</b> ⇒ D43	—	—	<b>SRSCR</b>	—
Double Lock (D)	D Type		<b>DCLN</b> ⇒ D41	—	<b>DDJN</b> ⇒ D41	—	—	—	—
			—	—	<b>DDHN</b> ⇒ D41	—	—	<b>DSBN</b> ⇒ D41	—

## Classification System for Polygon - Shank Holder

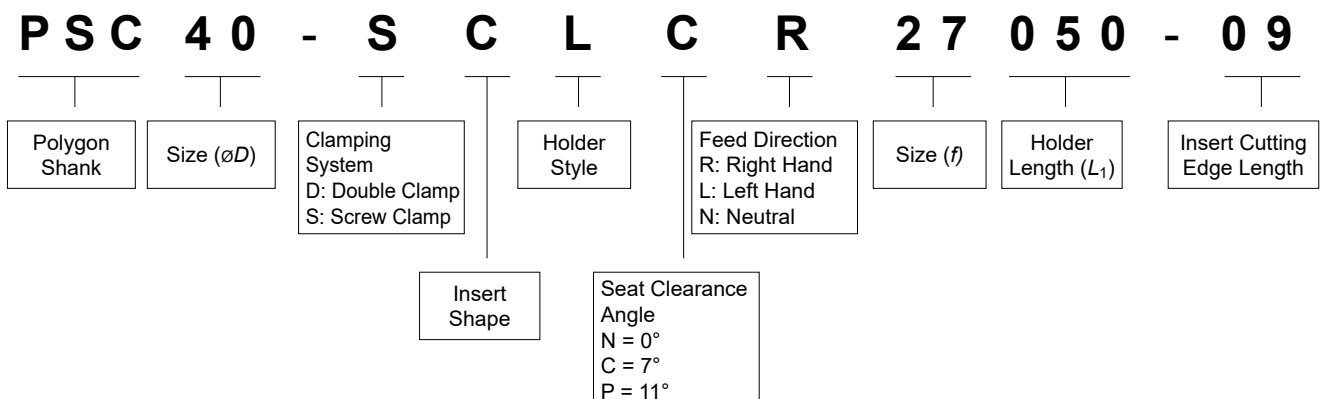

External Holders



Positive Insert Type

## TOOLING SELECTION

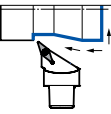
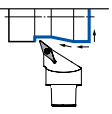
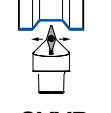
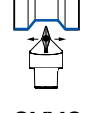
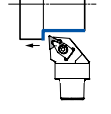
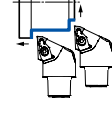
Application		General Turning			Copying		General Turning	Special Turning	
Insert Type		60° Triangle Type			35° Diamond Type		80° Trigon Type	Round and Special Purpose Inserts	
System									
Screw Lock System	S Type Mini Holder	 <b>STJC</b> ⇨ D44	-	-	 <b>SVJB</b> ⇨ D44 <b>SVHB</b> ⇨ D44	 <b>SVJC</b> ⇨ D45 <b>SVHC</b> ⇨ D45	-	-	-
		-	-	-	 <b>SVVB</b> ⇨ D44	 <b>SVVC</b> ⇨ D45	-	-	-
Double Lock (D)	D Type	 <b>DTJN</b> ⇨ D42	-	-	-	-	 <b>DWLN</b> ⇨ D42	-	-
		-	-	-	-	-	-	-	-

External Holders

## Classification System for Polygon - Shank Holder

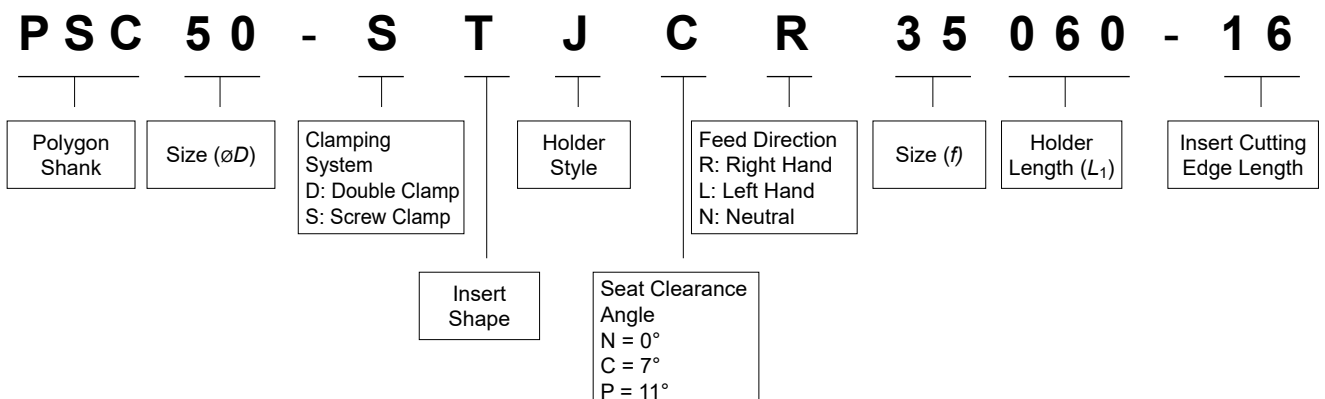



# ISO Holders Identification

## ■ Catalogue Classification System for Tool Holders

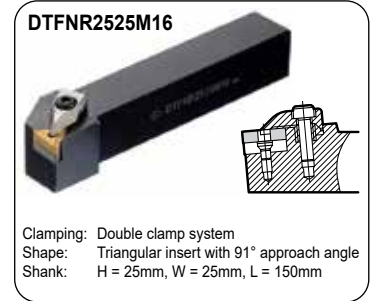
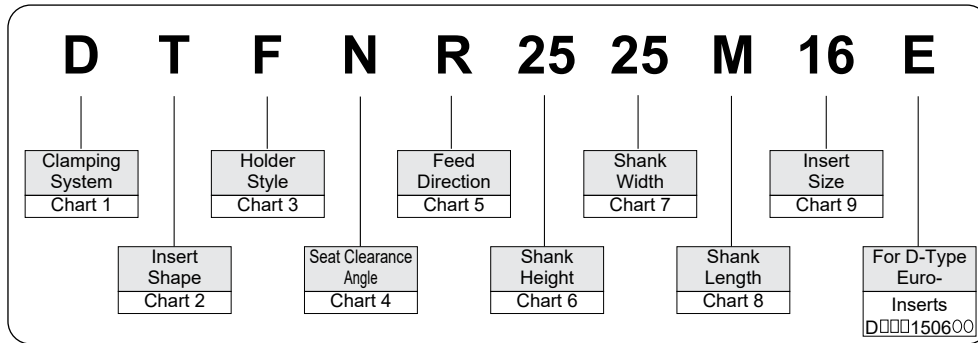

Chart 1

Clamping System					
Symbol	Clamp Types	Example of Structure	Symbol	Clamp Types	Example of Structure
C	Top Clamp		M	Top & Hole Clamp Type	
D	Double Clamp		P	Lever Lock Type (Insert is Supported by 1 face)	
E	Pin Lock Type (Insert is supported by 1 face)		S	Screw Clamp Type	

Chart 2

Insert Shape					
Symbol	Insert Shape	Symbol	Insert Shape	Symbol	Insert Shape
A	Parallelogram 85°	M	Rhombic 86°		
B	Parallelogram 82°	O	Octagonal		
C	Diamond 80°	P	Pentagonal		
D	Diamond 55°	R	Round		
E	Diamond 75°	S	Square		
F	Diamond 50°	T	Triangular		
H	Hexagonal	V	Diamond 35°		
K	Parallelogram 55°	W	Trigon		
L	Rectangular				

Chart 4

Seat Clearance Angle	
Symbol	Relief Angle
A	3°
B	5°
C	7°
D	15°
E	20°
F	25°
G	30°
N	0°
P	11°
O	Special Angle

Chart 5

Feed Direction					
Symbol	Right Hand Feed	Symbol	Neutral Feed	Symbol	Left Hand Feed
R		N		L	

Chart 3

Holder Style					
Symbol	Shape	Offset	Symbol	Shape	Offset
A		Nil	L		With Offset
B		Nil	N		Nil
D		Nil	R		With Offset
E		Nil	S		With Offset
F		With Offset	T		With Offset
G		With Offset	U		With Offset
J		With Offset	W		With Offset
K		With Offset	Y		With Offset

Chart 6

Shank Height		Shank Width	
Symbol	Height (mm)	Symbol	Width (mm)
	12		12
	16		16
	20		20
	25		25
	32		32
	40		40
	50		50
00	Round shank,		Shank Diameter is Shown for Round Shank,

2 digits are used for each dimension in mm.

Chart 7

Chart 8

Shank Length	
Symbol	Length (mm)
F	80
H	100
K	125
M	150
N	160
P	170
Q	180
S	250
T	300
U	350

For some Products, a Hyphen is used Instead of an alphabet.

Chart 9

Cutting Edge	
Symbol	Length (mm)
Eg. for Triangle Inserts:	
06	6,9
08	8,2
09	9,6
11	11,0
16	16,5
22	22,0
27	27,5
33	33,0

For Round Inserts:	
Symbol	Length (mm)
10	10
12	12
16	16
20	20
25	25
32	32

External Holders

## ■ Cutting Edge Dimensions by Corner Radius

(This table shows X and Y dimensions based on 0° approach angle cutting edge inclination)

Holders			Dimensions(mm)			Holders			Dimensions(mm)		
Symbol	Shapes	Corner Shapes	RE	X	Y	Symbol	Shapes	Corner Shapes	RE	X	Y
A			0,4	0,291	–	K			0,4	0,024	0,089
			0,8	0,581	–				0,8	0,048	0,178
			1,2	0,872	–				1,2	0,072	0,268
			1,6	1,162	–				1,6	0,096	0,357
			2,4	1,743	–				2,4	0,143	0,535
B			0,4	0,089	0,024	L			0,4	0,040	0,040
			0,8	0,178	0,048				0,8	0,079	0,079
			1,2	0,268	0,072				1,2	0,119	0,119
			1,6	0,357	0,096				1,6	0,159	0,159
			2,4	0,535	0,143				2,4	0,238	0,238
D			0,4	0,164	0,164	N			0,4	0,463	0,263
			0,8	0,329	0,329				0,8	0,925	0,471
			1,2	0,493	0,493				1,2	1,388	0,707
			1,6	0,658	0,658				1,6	1,850	0,943
			2,4	0,986	0,986				2,4	2,776	1,414
E			0,4	0,396	0,229	S			0,4	0,164	0,164
			0,8	0,793	0,458				0,8	0,329	0,329
			1,2	1,190	0,687				1,2	0,493	0,493
			1,6	1,587	0,916				1,6	0,658	0,658
			2,4	2,381	1,374				2,4	0,986	0,986
F			0,4	–	0,291	T			0,4	0,396	0,229
			0,8	–	0,581				0,8	0,793	0,458
			1,2	–	0,872				1,2	1,190	0,687
			1,6	–	1,162				1,6	1,587	0,916
			2,4	–	1,743				2,4	2,381	1,374
G			0,4	0,291	–	U			0,4	0,253	0,058
			0,8	0,581	–				0,8	0,506	0,116
			1,2	0,872	–				1,2	0,759	0,175
			1,6	1,162	–				1,6	1,013	0,233
			2,4	1,743	–				2,4	1,519	0,350
J			0,4	0,344	0,033	Y			0,4	0,002	0,033
			0,8	0,687	0,079				0,8	0,005	0,066
			1,2	1,031	0,118				1,2	0,008	0,099
			1,6	1,375	0,157				1,6	0,011	0,132
			2,4	2,062	0,236				2,4	0,017	0,198

### ● Calculation of the Nose Radius Dimensions

(Unit in mm)

Insert Shape	Calculation
	$B = \frac{3}{2}A - RE$
	$B = (\sqrt{2}-1) \times (\frac{A}{2} - RE)$
	$B = \{ \frac{1}{\sin(\theta/2)} - 1 \} \times (\frac{A}{2} - RE)$

### Figures of „A“ and „RE“ to calculate Figure „B“

I.C. size (inch)	„A“ dimensions (mm)	Nose symbol	Size (inch)	„RE“ dimension (mm)
–	5/32	02	(0)	0,203
–	6/32	04	1/64	0,397
–	7/32	08	2/64	0,794
2/8	8/32	12	3/64	1,191
–	(0)	16	4/64	1,588
3/8	–	24	6/64	2,389
4/8	–			
5/8	–			
6/8	–			
8/8	–			

# SumiTurn T-REX Tool Holders

RIGIDITY - ECONOMY - PRECISION

External Holders  
for neg. Inserts



- T-REX clamping for maximum rigidity 50 % more cutting edges than a DNMG Insert



## Advantages

- T-REX Inserts for Maximum Economy  
With 6 cutting edges and a 55 degree included angle - T-Rex is the intelligent alternative to profile turning with a traditional 4 edge DNMG insert.
- Biting Performance from T-REX Teeth  
The double clamp tool holder and powerful teeth of T-REX lock the insert to eliminate movement, dramatically improving tool life, machining accuracy, and cutting edge security.

## Application Range

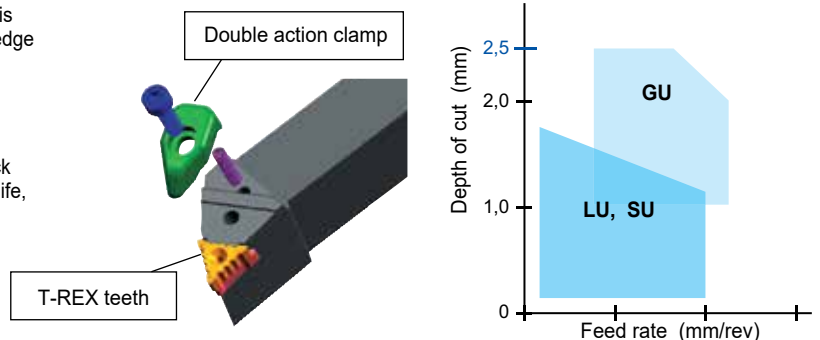

## Application Examples

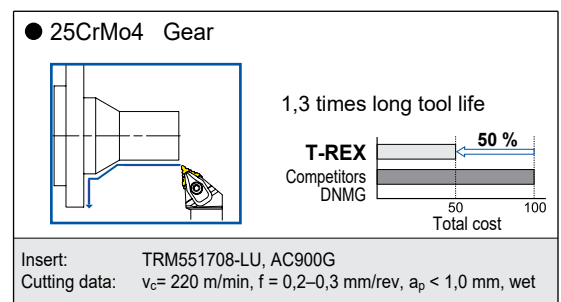
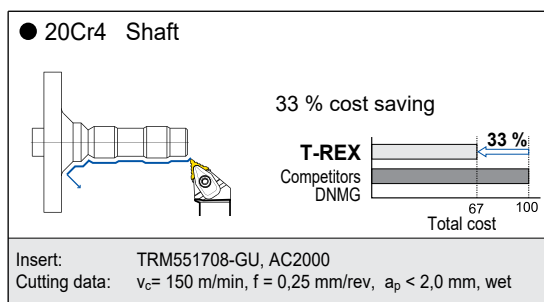

## Recommendations

### Depth of Cut



Max.  $a_p = 2,5$  mm

### Approach Angle

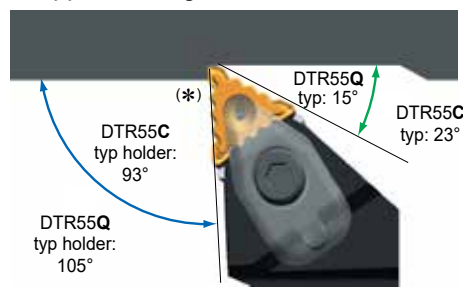

C-Type: 95,5°  
Q-Type: 107,5°

### Insert Clamping

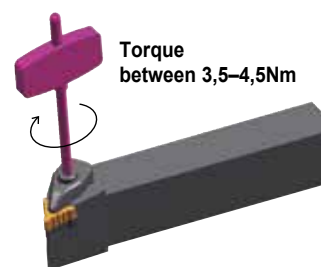

Recommended Tightening Torque (N·m)

- = Euro stock
- = Japan stock

## External Turning & Copying

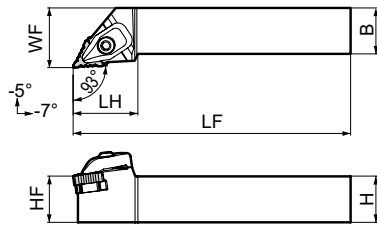
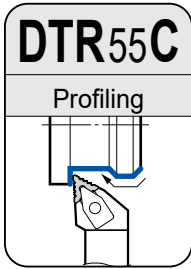

### ■ Holders

Above figures show right hand tools.

Cat. No.	Stock		Dimensions (mm)					
	R	L	H	HF	B	LF	LH	WF
DTR 55C-R/L 2020-K17	●	●	20	20	20	125	35	25
DTR 55C-R/L 2525-M17	●	●	25	25	25	150	35	32

### ■ Spare Parts

Clamp	Spring	Screw	Shim	Screw	Wrench	Wrench
TRCP3	S-SP4-20	BX0520 3,5-4,5 (Nm)	TRW5505	BFTX0307N 2,0 (Nm)	TSW040	TRX10 <sup>(*)</sup>

(\*) Note: Wrench (TRX) for shim clamp screw is not included.

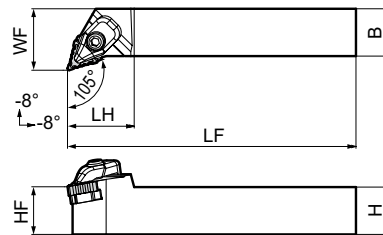
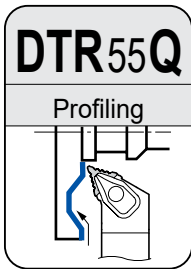

### ■ Holders

Above figures show right hand tools.

Cat. No.	Stock		Dimensions (mm)					
	R	L	H	HF	B	LF	LH	WF
DTR 55Q-R/L 2020-K17	●	●	20	20	20	125	35	28,5
DTR 55Q-R/L 2525-M17	●	●	25	25	25	150	35	32

### ■ Spare Parts

Clamp	Spring	Screw	Shim	Screw	Wrench	Wrench
TRCP3	S-SP4-20	BX0520 3,5-4,5 (Nm)	TRW5505	BFTX0307N 2,0 (Nm)	TSW040	TRX10 <sup>(*)</sup>

(\*) Note: Wrench (TRX) for shim clamp screw is not included.

### ■ Inserts

Applic.	Shape	Ordering No.	RE	Coated Carbide			Coated Cermet
				AC8015P	AC8025P	AC630M	T3000Z
Fine Finishing	FL	TRM 551704-FL	0,4		○		○
		551708-FL	0,8		○		○
Finishing	LU	TRM 551704-LU	0,4	●	○		○
		551708-LU	0,8	●	○		○
		551712-LU	1,2		○		○
Finishing	SU	TRM 551704-SU	0,4		○	●	○
		551708-SU	0,8		○	●	○
		551712-SU	1,2		○		
Light Cut	GU	TRM 551704-GU	0,4		○	●	
		551708-GU	0,8		○	●	
		551712-GU	1,2		○	○	

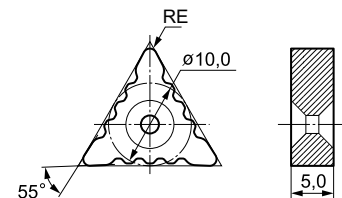

Application **P** Steel  
**M** Stainless steel

# External Tool Holders D Type (Double Clamp)

## Tool Holders for neg. Inserts CN



### ■ Characteristics

Insert is clamping firmly for improved fracture resistance.  
High indexing accuracy improves machining accuracy.  
Insert can be changed from below the holder.  
Suitable for high efficiency machining and interrupted cutting in hardened steel.

### ■ Clamp Mechanism

Secured in two directions and supported by two faces.

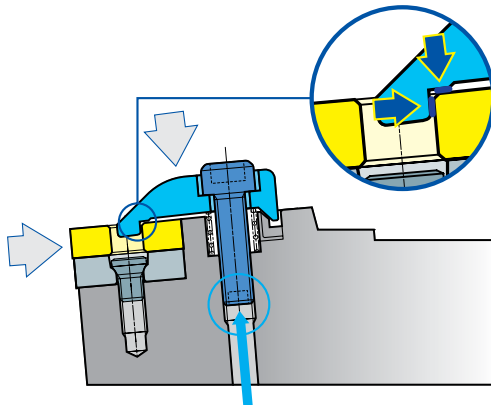

Insert can be changed from below the holder.

### ■ Index Accuracy Comparison (Length Wise)

#### D Type Tool Holders

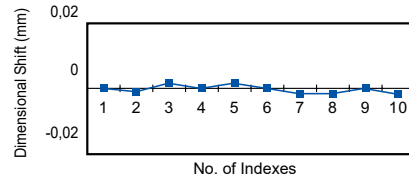

#### Lever Lock

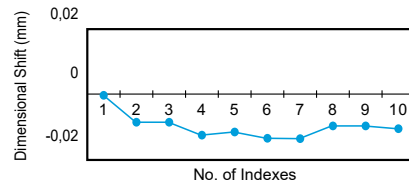

### General Turning and Facing



### ■ Inserts

Eg.

N-GU

- ① CNMG 120408 N-GU
- ② CNMG 160608 N-GU
- ③ CNMM 190612 N-HG
- ④ CNMM 250924 N-HU

### ■ Spare Parts

Clamp	Spring	Clamp bolt	Shim	Shim Screw	Wrench (TRX / TRD)	Wrench	Insert
	SCP2	5,0 (N·m)	CNS1204	BFTX0409N 3,4 (N·m)	TRX15 <sup>(*)</sup>	LH040 LH025	①
	SCP3	5,0 (N·m)	CNS1606	BFTX0509N 5,0 (N·m)	TRX20 <sup>(*)</sup>	LH040 LH025	②
	SCP5	5,0 (N·m)	CNS1906	BFTX0511N 5,0 (N·m)	TRX20 <sup>(*)</sup>	LH040 LH025	③
	SCP6	6,0 (N·m)	CNS2509	BFTX0615N 7,5 (N·m)	TRD25 <sup>(*)</sup>	LH060	④

(\*) Note: Wrench (TRX / TRD) for shim clamp screw is not included.

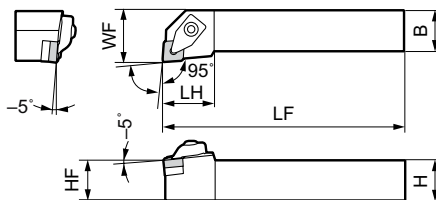
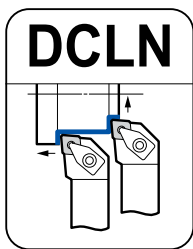

### ■ Holders

Above figures show right hand tools.

Cat. No.	Stock		Dimensions (mm)					
	R	L	H	HF	B	LF	LH	WF
DCLN R/L 2020 K12	●	●	20	20	20	125	32	25
DCLN R/L 2525 M12	●	●	25	25	25	150	32	32
DCLN R/L 2525 M16	●	●	25	25	25	150	32	32
DCLN R/L 3232 P16	●	●	32	32	32	170	32	40
DCLN R/L 3232 P19	●	●	32	32	32	170	42	40
DCLN R/L 4040 S19	●	●	40	40	40	250	42	50
DCLN R/L 4040 S25	○	●	40	40	40	250	53	50

● = Euro stock  
○ = Japan stock

(N·m) Recommended Tightening Torque (N·m)

## General Turning and Copying

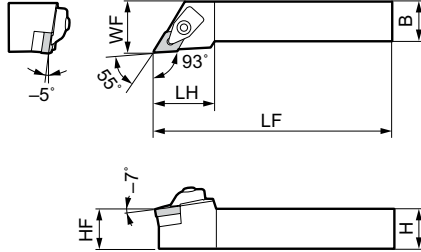
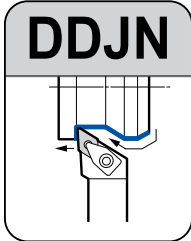

### ■ Holders

Above figures show right hand tools.

Cat. No.	Stock		Dimensions (mm)						Clamp	Spring	Clamp bolt	Shim	Shim Screw	Wrench	Wrench	Insert
	R	L	H	HF	B	LF	LH	WF								
DDJN R/L 2020 K15	○	●	20	20	20	125	38	25	SCP2	5,0 (Nm)	DNS1504	BFTX0409N	TRX15 <sup>(*)</sup>	LH040	●	
DDJN R/L 2020 K15E	●	●	20	20	20	125	38	25			DNS1506					●
DDJN R/L 2525 M15	○		25	25	25	150	38	32			DNS1504					●
DDJN R/L 2525 M15E	●	●	25	25	25	150	38	32			DNS1506					3,4 (Nm)

(\*) Note: Wrench (TRX) for shim clamp screw is not included.

### ■ Inserts

Eg.

N-GU

- ① DNMG 150408 N-GU
- ② DNMG 150608 N-GU

### ■ Spare Parts

							Insert
--	--	--	--	--	--	--	--------

### ■ Inserts

Eg.

N-GU

- ② DNMG 150608 N-GU

### ■ Spare Parts

							Insert
--	--	--	--	--	--	--	--------

(\*) Note: Wrench (TRX) for shim clamp screw is not included.

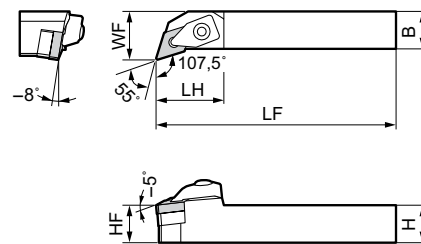
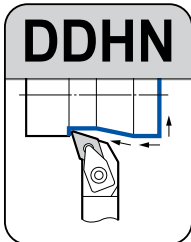

### ■ Holders

Above figures show right hand tools.

Cat. No.	Stock		Dimensions (mm)						Clamp	Spring	Clamp bolt	Shim	Shim Screw	Wrench	Wrench	Insert
	R	L	H	HF	B	LF	LH	WF								
DDHN R/L 2020 K15E	●	●	20	20	20	125	35	25	SCP2	5,0 (Nm)	DNS1506	BFTX0409N	TRX15 <sup>(*)</sup>	LH040	●	
DDHN R/L 2525 M15E	●	●	25	25	25	150	35	32								3,4 (Nm)

### ■ Inserts

Eg.

N-GU

- ② DNMG 150608 N-GU

### ■ Spare Parts

							Insert
--	--	--	--	--	--	--	--------

(\*) Note: Wrench (TRX) for shim clamp screw is not included.

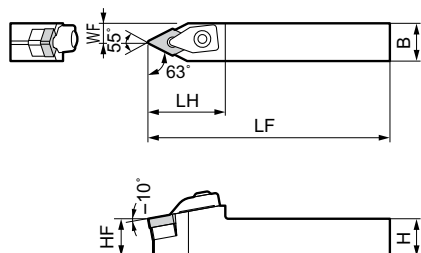
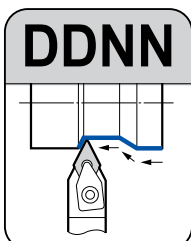

### ■ Holders

Above figures show right hand tools.

Cat. No.	Stock	Dimensions (mm)						Clamp	Spring	Clamp bolt	Shim	Shim Screw	Wrench	Wrench	Insert
		H	HF	B	LF	LH	WF								
DDNN N 2020 K15E	●	20	20	20	125	40	10,5	SCP2	5,0 (Nm)	DNS1506	BFTX0409N	TRX15 <sup>(*)</sup>	LH040	●	
DDNN N 2525 M15E	●	25	25	25	150	40	13,0								3,4 (Nm)



# External Tool Holders D Type (Double Clamp)

## Tool Holders for neg. Inserts SN



### General Turning and Facing

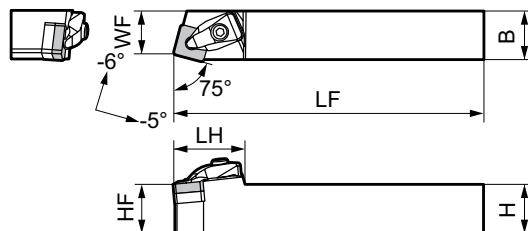
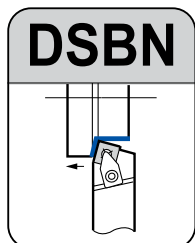

### ■ Inserts

Eg.

N-UZ, N-HU

- ① SNMG 190612 N-UZ
- ② SNMM 250724 N-HU
- ③ SNMM 250924 N-HU

### ■ Spare Parts

Clamp	Spring	Clamp bolt	Shim	Shim Screw	Wrench (TRX)	Wrench (TRD)	Insert
SCP2		5,0 <sup>(Nm)</sup>	SNS1204	BFTX0409N	TRX15 <sup>(*)</sup>	LH040, LH025	
SCP5		5,0 <sup>(Nm)</sup>	SNS1906	BFTX0511N 5,0 <sup>(Nm)</sup>	TRX20 <sup>(*)</sup>	LH040, LH025	①
SCP6		6,0 <sup>(Nm)</sup>	SNS2507 SNS2509	BFTX0615N 7,5 <sup>(Nm)</sup>	TRD25 <sup>(*)</sup>	LH060	② ③

(\*) Note: Wrench (TRX / TRD) for shim clamp screw is not included.

### ■ Holders

Above figures show right hand tools.

Cat. No.	Stock		Dimensions (mm)						
	R	L	H	HF	B	LF	LH	WF	
DSBN R/L 2525 M12	○	○	25	25	25	150	36	22	
DSBN R/L 3232 P19	●	●	32	32	32	170	45	27	
DSBN R/L 4040 S2507	○	○	40	40	40	250	58	35	
DSBN R/L 4040 S2509	○	○	40	40	40	250	58	35	

### ■ Inserts

Eg.

N-UZ, N-HU

- ① SNMG 190612 N-UZ
- ② SNMM 250724 N-HU
- ③ SNMM 250924 N-HU

### ■ Spare Parts

Clamp	Spring	Clamp bolt	Shim	Shim Screw	Wrench (TRX)	Wrench (TRD)	Insert
SCP5		5,0 <sup>(Nm)</sup>	SNS1906	BFTX0511N 5,0 <sup>(Nm)</sup>	TRX20 <sup>(*)</sup>	LH040, LH025	①
SCP6		6,0 <sup>(Nm)</sup>	SNS2507 SNS2509	BFTX0615N 7,5 <sup>(Nm)</sup>	TRD25 <sup>(*)</sup>	LH060	② ③

(\*) Note: Wrench (TRX / TRD) for shim clamp screw is not included.

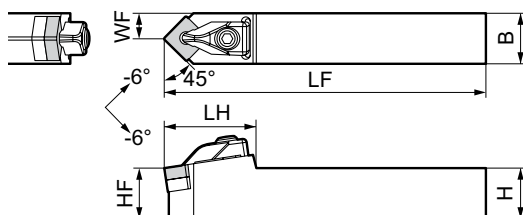
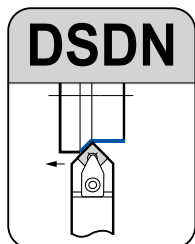

### ■ Holders

Above figures show right hand tools.

Cat. No.	Stock		Dimensions (mm)						
	H	HF	B	LF	LH	WF			
DSDN N 3232 P19	●	32	32	32	170	50	16		
DSDN N 4040 S2507		40	40	40	250	63	20		
DSDN N 4040 S2509		40	40	40	250	63	20		

## General Turning and Facing

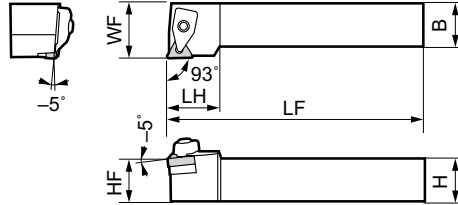
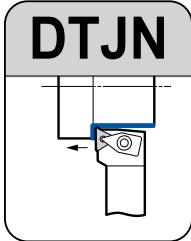
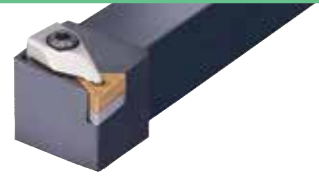

### ■ Holders

Above figures show right hand tools.

Cat. No.	Stock		Dimensions (mm)					
	R	L	H	HF	B	LF	LH	WF
DTJN R/L 2020 K16	●		20	20	20	125	31	25
DTJN R/L 2525 M16	●	●	25	25	25	150	31	32

### ■ Inserts



### ■ Spare Parts

Clamp	Spring	Clamp bolt	Shim	Shim Screw	Wrench	Wrench	Insert
SCP1		5,0 <sup>(N·m)</sup>	TNS1604	BFTX0307N 2,0 <sup>(N·m)</sup>	TRX10 <sup>(*)</sup>	LH040	①

(\*) Note: Wrench (TRX) for shim clamp screw is not included.

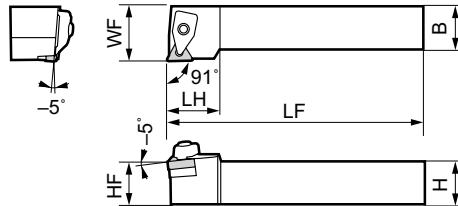
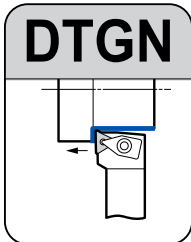

### ■ Holders

Above figures show right hand tools.

Cat. No.	Stock		Dimensions (mm)					
	R	L	H	HF	B	LF	LH	WF
DTGN R/L 2020 K16	○		20	20	20	125	31	25
DTGN R/L 2525 M16	●		25	25	25	150	31	32

### ■ Inserts

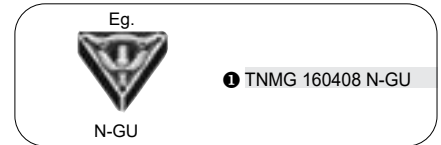

### ■ Spare Parts

Clamp	Spring	Clamp bolt	Shim	Shim Screw	Wrench	Wrench	Insert
SCP1		5,0 <sup>(N·m)</sup>	TNS1604	BFTX0307N 2,0 <sup>(N·m)</sup>	TRX10 <sup>(*)</sup>	LH040	①

(\*) Note: Wrench (TRX) for shim clamp screw is not included.

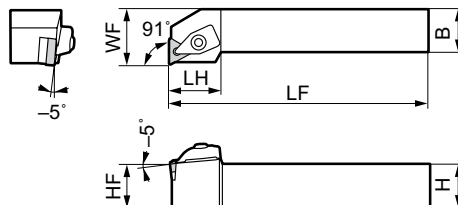
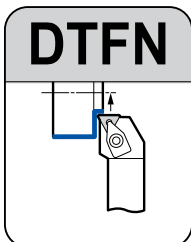

### ■ Holders

Above figures show right hand tools.

Cat. No.	Stock		Dimensions (mm)					
	R	L	H	HF	B	LF	LH	WF
DTFN R/L 2020 K16	○	○	20	20	20	125	30	25
DTFN R/L 2525 M16	●	●	25	25	25	150	30	32

### ■ Inserts

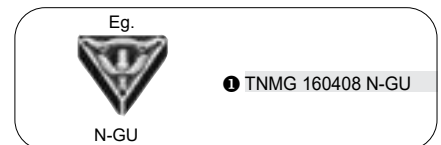

### ■ Spare Parts

Clamp	Spring	Clamp bolt	Shim	Shim Screw	Wrench	Wrench	Insert
SCP1		5,0 <sup>(N·m)</sup>	TNS1604	BFTX0307N 2,0 <sup>(N·m)</sup>	TRX10 <sup>(*)</sup>	LH040	①

(\*) Note: Wrench (TRX) for shim clamp screw is not included.

External Holders  
for neg. Inserts

# External Tool Holders D Type (Double Clamp)

## Tool Holders for neg. Inserts VN

### General Turning and Copying

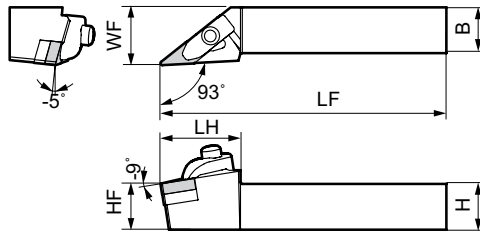
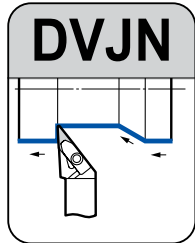

#### ■ Holders

Above figures show right hand tools.

Cat. No.	Stock		Dimensions (mm)					
	R	L	H	HF	B	LF	LH	WF
DVJN R/L 2020 K16	●	●	20	20	20	125	35	25
DVJN R/L 2525 M16	●	●	25	25	25	150	35	32

#### ■ Inserts

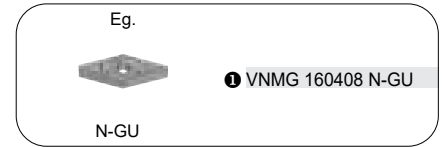

#### ■ Spare Parts

Clamp	Spring	Clamp bolt	Shim	Shim Screw	Wrench	Wrench	Insert
SCP4		5,0 <sup>(Nm)</sup>	VNS1604	BFTX0307N 2,0 <sup>(Nm)</sup>	TRX10 <sup>(*)</sup>	LH040 LH025	

(\*) Note: Wrench (TRX) for shim clamp screw is not included.

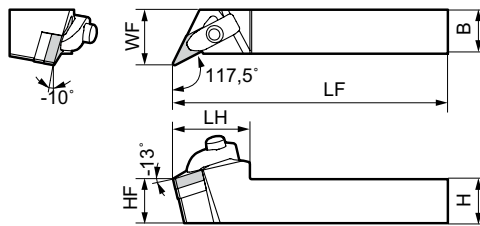

#### ■ Holders

Above figures show right hand tools.

Cat. No.	Stock		Dimensions (mm)					
	R	L	H	HF	B	LF	LH	WF
DVQN R/L 2020 K16	●	●	20	20	20	125	35	25
DVQN R/L 2525 M16	●	●	25	25	25	150	35	32

#### ■ Inserts

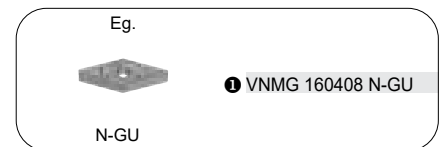

#### ■ Spare Parts

Clamp	Spring	Clamp bolt	Shim	Shim Screw	Wrench	Wrench	Insert
SCP4		5,0 <sup>(Nm)</sup>	VNS1604	BFTX0307N 2,0 <sup>(Nm)</sup>	TRX10 <sup>(*)</sup>	LH040 LH025	

(\*) Note: Wrench (TRX) for shim clamp screw is not included.

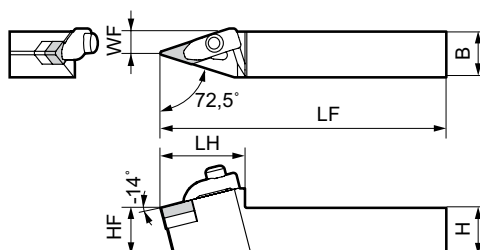
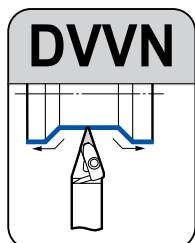

#### ■ Holders

Above figures show right hand tools.

Cat. No.	Stock	Dimensions (mm)					
		H	HF	B	LF	LH	WF
DVVN N 2020 K16	●	20	20	20	125	37	10,0
DVVN N 2525 M16	●	25	25	25	150	37	12,5

#### ■ Spare Parts

Clamp	Spring	Clamp bolt	Shim	Shim Screw	Wrench	Wrench	Insert
SCP4		5,0 <sup>(Nm)</sup>	VNS1604	BFTX0307N 2,0 <sup>(Nm)</sup>	TRX10 <sup>(*)</sup>	LH040 LH025	

(\*) Note: Wrench (TRX) for shim clamp screw is not included.

General Turning and Facing

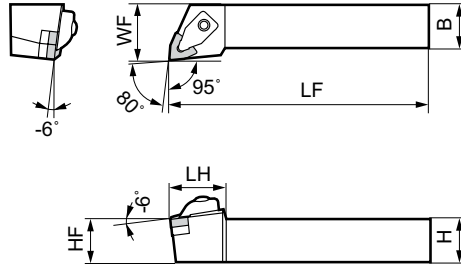
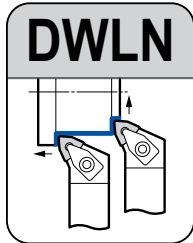

■ Inserts



■ Spare Parts

							Insert
Clamp	Spring	Clamp bolt	Shim	Shim Screw	Wrench	Wrench	
	SCP2	5,0 <sup>(NPT)</sup>	WNS0804	BFTX0409N 3,4 <sup>(NPT)</sup>	TRX15 <sup>(*)</sup>	LH040 LH025	1

■ Holders

Above figures show right hand tools.

Cat. No.	Stock		Dimensions (mm)						
	R	L	H	HF	B	LF	LH	WF	
DWLN R/L 2020 K08	●	●	20	20	20	125	32	25	
DWLN R/L 2525 M08	●	●	25	25	25	150	32	32	

(\*) Note: Wrench (TRX) for shim clamp screw is not included.

# External Tool Holders P Type (Lever Lock)

## Tool Holders for neg. Inserts CN

### General Turning and Facing

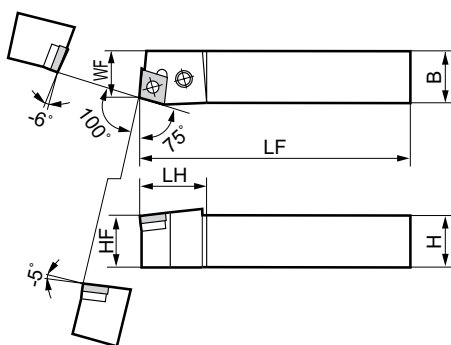
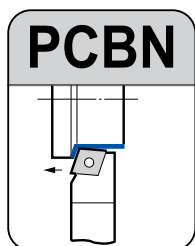

#### ■ Inserts

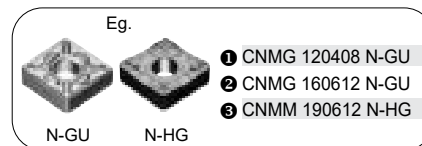

#### ■ Spare Parts

Cat. No.	Stock		Dimensions (mm)							Lever pin	Clamp bolt	Shim	Shim pin	Wrench	Insert	
	R	L	H	HF	B	LF	LH	WF								
PCBN R/L 2020 K12	●	○	20	20	20	125	27	17								
PCBN R/L 2525 M12	●	●	25	25	25	150	27,7	22		LCL4SD	LCS42BS-SD	LSC42SD	LSP4SD	LH030	①	
PCBN R/L 3225 P12		●	32	32	25	170	27,7	22								
PCBN R/L 2525 M16		●	25	25	25	150	31,7	22		LCL5SD	LCS5B-SD	LSC53SD	LSP5SD	LH030	②	
PCBN R/L 3225 P16			32	32	25	170	31,7	22								
PCBN R/L 3232 P19	●	●	32	32	32	170	37,9	27		LCL6SD	LCS6B-SD	LSC63SD	LSP6SD	LH040	③	

#### ■ Holders

Above figures show right hand tools.

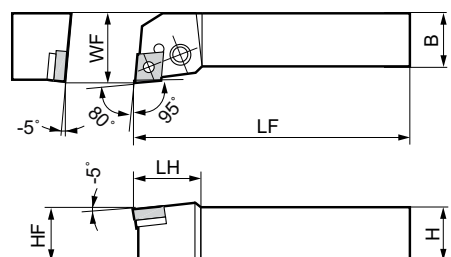
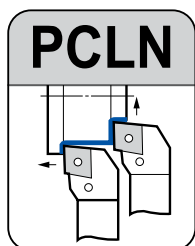

#### ■ Inserts

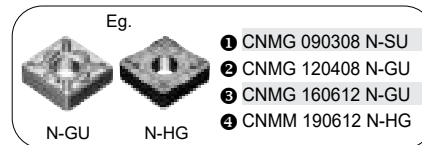

#### ■ Spare Parts

Cat. No.	Stock		Dimensions (mm)							Lever pin	Clamp bolt	Shim	Shim pin	Wrench	Insert
	R	L	H	HF	B	LF	LH	WF							
PCLN R/L 1616 H09	●	●	16	16	16	100	25,7	20							
PCLN R/L 2020 K09	●		20	20	20	125	27	25		LCL3SD	LCS3TB-SD	LSC32SD	LSP3SD	LH025	①
PCLN R/L 2525 M09			25	25	25	150	27	32							
PCLN R/L 1616 H12	●	●	16	16	16	100	26,1	20			LCS 4CA				
PCLN R/L 2020 K12	●	○	20	20	20	125	27,4	25		LCL4SD	LCS42BS-SD	LSC42SD	LSP4SD	LH030	②
PCLN R/L 2525 M12	●	●	25	25	25	150	28	32							
PCLN R/L 3225 P12	●	●	32	32	25	170	28	32							
PCLN R/L 2525 M16	●		25	25	25	150	32,6	32		LCL5SD	LCS5B-SD	LSC53SD	LSP5SD	LH030	③
PCLN R/L 3225 P16	●		32	32	25	170	32,6	32							
PCLN R/L 3232 P16	●	●	32	32	32	170	32,6	40							
PCLN R/L 2525 M19	●	●	25	25	25	150	37	32							
PCLN R/L 3225 P19	○		32	32	32	170	38	32		LCL6SD	LCS6B-SD	LSC63SD	LSP6SD	LH040	④
PCLN R/L 3232 P19			32	32	32	170	38	40							
PCLN R/L 4040 S19			40	40	40	250	37,8	50							

#### ■ Holders

Above figures show right hand tools.

General Turning and Facing

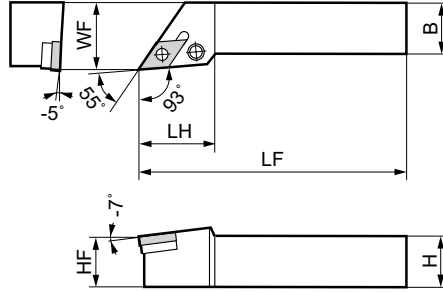
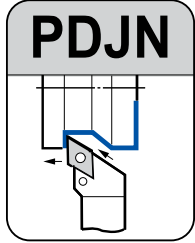

■ Holders

Above figures show right hand tools.

Cat. No.	Stock		Dimensions (mm)						
	R	L	H	HF	B	LF	LH	WF	
PDJN R/L 1616 H11	●		16	16	16	100	30	20	
PDJN R/L 2020 K11	●	●	20	20	20	125	30	25	
PDLN R/L 2525 M11	●	●	25	25	25	150	30	32	
PDJN R/L 2020 K15	●	●	20	20	20	125	34,7	25	
PDJN R/L 2525 M15	●	●	25	25	25	150	34,7	32	
PDJN R/L 3225 P15	●	●	32	32	25	170	34,7	32	

■ Inserts

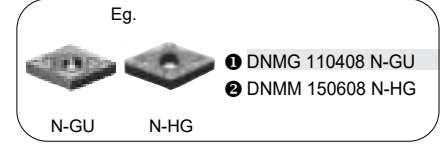

■ Spare Parts

Lever pin	Clamp bolt	Shim	Shim pin	Wrench	Insert
LCL3D-SD	LCS3TB-SD	LSD32SD	LSP3SD	LH025	1
LCL4D-SD	LCS5DB-SD	LSD42SD	LSP4SD	LH030	2

External Holders for neg. Inserts



# External Tool Holders P Type (Lever Lock)

## Tool Holders for neg. Inserts SN



### General Turning and Chamfering

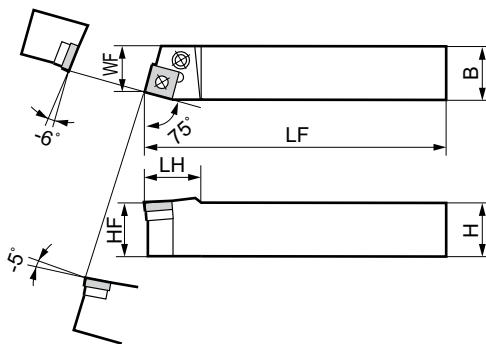
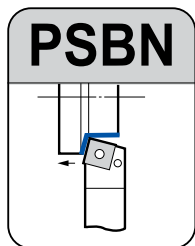

#### ■ Inserts

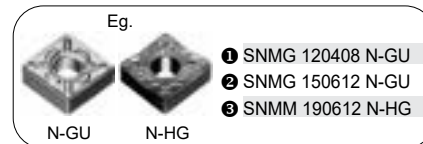

#### ■ Spare Parts

Cat. No.	Stock		Dimensions (mm)							Lever pin	Clamp bolt	Shim	Shim pin	Wrench	Insert
	R	L	H	HF	B	LF	LH	WF							
PSBN R/L 2020 K12	●		20	20	20	125	27,5	17		LCL4SD	LCS42BS-SD	LSS42SD	LSP4SD	LH030	❶
PSBN R/L 2525 M12	●	●	25	25	25	150	27,5	22		LCL5SD	LCS5B-SD	LSS53SD	LSP5SD	LH030	❷
PSBN R/L 2525 M15		●	25	25	25	150	32	22		LCL5SD	LCS5B-SD	LSS53SD	LSP5SD	LH030	❷
PSBN R/L 3225 P15	●	●	32	32	25	170	32	22		LCL6SD	LCS6B-SD	LSS63SD	LSP6SD	LH040	❸
PSBN R/L 3232 P19	●	●	32	32	32	170	39,2	27		LCL6SD	LCS6B-SD	LSS63SD	LSP6SD	LH040	❸

#### ■ Holders

Above figures show right hand tools.

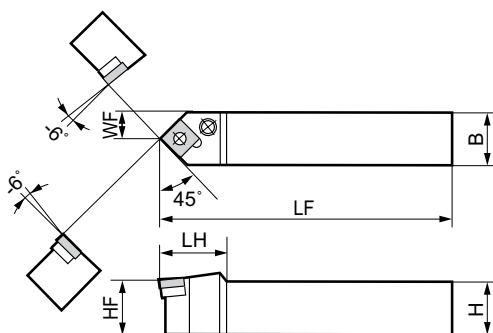
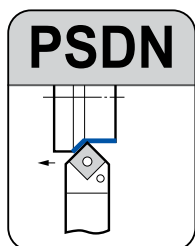

#### ■ Inserts

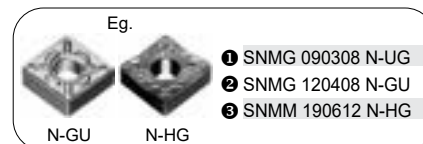

#### ■ Spare Parts

Cat. No.	Stock		Dimensions (mm)							Lever pin	Clamp bolt	Shim	Shim pin	Wrench	Insert
	H	HF	B	LF	LH	WF									
PSDN N 1616 H09	●		16	16	16	100	21	8,3		LCL3SD	LCS 3TB-SD	LSS32SD	LSP3SD	LH025	❶
PSDN N 2020 K12	●		20	20	20	125	27,6	10,3		LCL4SD	LCS42BS-SD	LSS42SD	LSP4SD	LH030	❷
PSDN N 2525 M12	●		25	25	25	150	27,6	12,8		LCL4SD	LCS42BS-SD	LSS42SD	LSP4SD	LH030	❷
PSDN N 3225 P12	●		32	32	25	170	27,6	12,8		LCL4SD	LCS42BS-SD	LSS42SD	LSP4SD	LH030	❷
PSDN N 3225 P19			32	32	25	170	40,6	13		LCL6SD	LCS6B-SD	LSS63SD	LSP6SD	LH040	❸
PSDN N 3232 P19	●		32	32	32	170	40,6	16,5		LCL6SD	LCS6B-SD	LSS63SD	LSP6SD	LH040	❸

#### ■ Holders

● = Euro stock

## General Turning and Facing

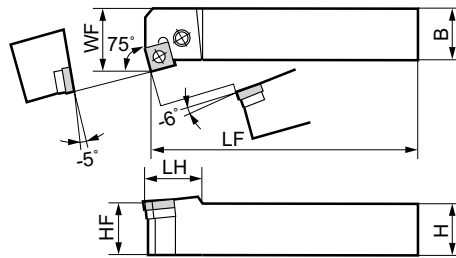
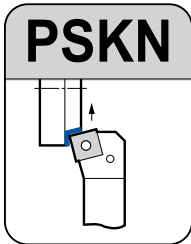

### ■ Holders

Above figures show right hand tools.

Cat. No.	Stock		Dimensions (mm)						
	R	L	H	HF	B	LF	LH	WF	
PSKN R/L 2020 K12	●		20	20	20	125	22,7	17	
PSKN R/L 2525 M12	●	●	25	25	25	150	22,7	32	
PSKN R/L 2525 M15			25	25	25	150	32	32	
PSKN R/L 3225 P15			32	32	25	170	32	32	
PSKN R/L 3232 P19			32	32	32	170	33,7	40	

### ■ Inserts



### ■ Spare Parts

Lever pin	Clamp bolt	Shim	Shim pin	Wrench	Insert
LCL4SD	LCS42BS-SD	LSS42SD	LSP4SD	LH030	1
LCL5SD	LCS5B-SD	LSS53SD	LSP5SD	LH030	2
LCL6SD	LCS6B-SD	LSS63SD	LSP6SD	LH040	3

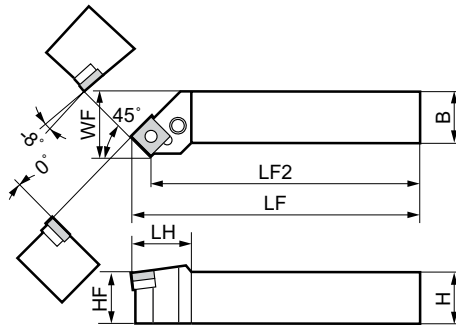
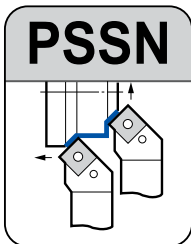

### ■ Holders

Above figures show right hand tools.

Cat. No.	Stock		Dimensions (mm)						
	R	L	H	HF	B	LF	LF2	LH	WF
PSSN R/L 2020 K12	●	●	20	20	20	125	116,7	29,3	25
PSSN R/L 2525 M12	●	●	25	25	25	150	141,7	29,3	32
PSSN R/L 3225 P12	●		32	32	25	170	161,7	29,3	32
PSSN R/L 2525 M15	●	●	25	25	25	150	139,8	32	32
PSSN R/L 3225 P15			32	32	25	170	159,8	32	32
PSSN R/L 3232 P15	●		32	32	32	170	159,8	32	40
PSSN R/L 3232 P19	●	●	32	32	32	170	157,5	40,2	40

### ■ Inserts

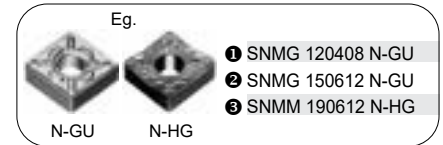

### ■ Spare Parts

Lever pin	Clamp bolt	Shim	Shim pin	Wrench	Insert
LCL4SD	LCS42BS-SD	LSS42SD	LSP4SD	LH030	1
LCL5SD	LCS5B-SD	LSS53SD	LSP5SD	LH030	2
LCL6SD	LCS6B-SD	LSS63SD	LSP6SD	LH040	3

# External Tool Holders P Type (Lever Lock)

## Tool Holders for neg. Inserts TN



### General Turning and Facing

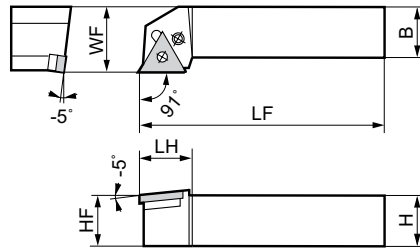
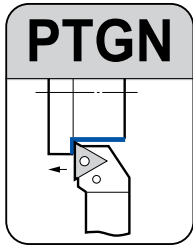

#### ■ Holders

Above figures show right hand tools.

Cat. No.	Stock		Dimensions (mm)						
	R	L	H	HF	B	LF	LH	WF	
PTGN R/L 1616 H16	●		16	16	16	100	20	20	
PTGN R/L 2020 K16	●	●	20	20	20	125	20	25	
PTGN R/L 2525 M16	●	●	25	25	25	150	22,2	32	
PTGN R/L 2525 M22	●	●	25	25	25	150	28,7	32	
PTGN R/L 3225 P22	●		32	32	25	170	28,7	32	
PTGN R/L 3232 P22	●		32	32	32	170	28,7	32	

#### ■ Inserts

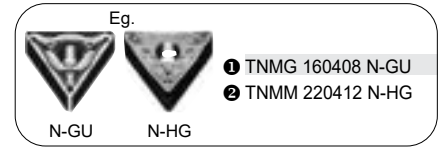

#### ■ Spare Parts

Lever pin	Clamp bolt	Shim	Shim pin	Wrench	Insert
LCL3SD	LCS3TB-SD	LST317SD	LSP3SD	LH025	①
LCL4SD	LCS42BS-SD	LST42SD	LSP4SD	LH030	②

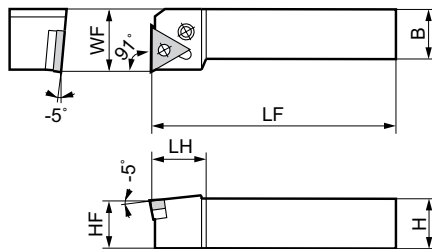
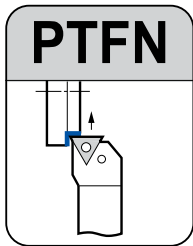

#### ■ Holders

Above figures show right hand tools.

Cat. No.	Stock		Dimensions (mm)						
	R	L	H	HF	B	LF	LH	WF	
PTFN R/L 1616 H16			16	16	16	100	19,7	20	
PTFN R/L 2020 K16	●	●	20	20	20	125	20,2	25	
PTFN R/L 2525 M16	●	●	25	25	25	150	20,2	32	
PTFN R/L 2525 M22	●		25	25	25	150	25,2	32	
PTFN R/L 3225 P22	●		32	32	25	170	25,2	32	

#### ■ Inserts

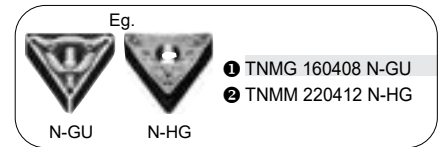

#### ■ Spare Parts

Lever pin	Clamp bolt	Shim	Shim pin	Wrench	Insert
LCL3SD	LCS3TB-SD	LST317SD	LSP3SD	LH025	①
LCL4SD	LCS42BS-SD	LST42SD	LSP4SD	LH030	②

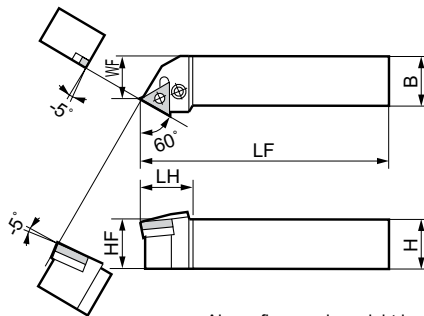
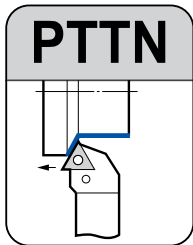

#### ■ Holders

Above figures show right hand tools.

Cat. No.	Stock		Dimensions (mm)						
	R	L	H	HF	B	LF	LH	WF	
PTTN R/L 2020 K16	○		20	20	20	125	25,9	17	
PTTN R/L 2525 M16	●		25	25	25	150	25,9	22	
PTTN R/L 3225 P22			31	32	25	170	31,9	22	

#### ■ Inserts



#### ■ Spare Parts

Lever pin	Clamp bolt	Shim	Shim pin	Wrench	Insert
LCL3SD	LCS3TB-SD	LST317SD	LSP3SD	LH025	①
LCL4SD	LCS42BS-SD	LST42SD	LSP4SD	LH030	②

## General Turning and Copying

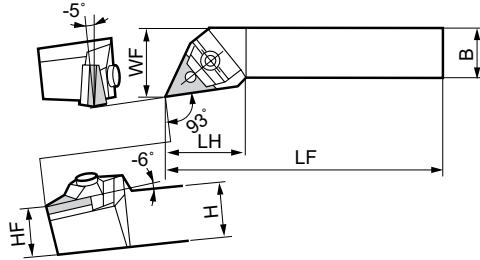
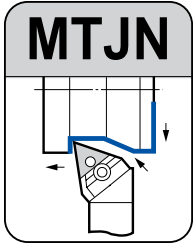

### ■ Holders

Above figures show right hand tools.

Cat. No.	Stock		Dimensions (mm)						
	R	L	H	HF	B	LF	LH	WF	
MTJN R/L 2020-33 (K16)	●	●	20	20	20	125	37	25	
MTJN R/L 2525-33 (M16)	●	●	25	25	25	150	37	32	
MTJN R/L 2525-43 (M22)	●	●	25	25	25	150	37	32	
MTJN R/L 3225-43 (P22)	○	○	32	32	25	170	37	32	

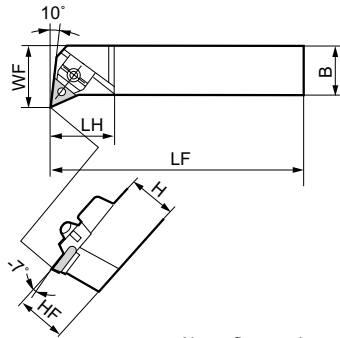
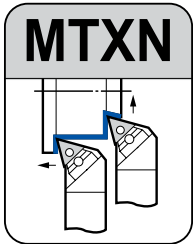

### ■ Holders

Above figures show right hand tools.

Cat. No.	Stock		Dimensions (mm)						
	R	L	H	HF	B	LF	LH	WF	
MTXN R/L 2020-33 (K16)	○	○	20	20	20	125	32	25	
MTXN R/L 2525-33 (M16)	○	○	25	25	25	150	32	32	
MTXN R/L 2525-43 (M22)			25	25	25	150	38	32	



### ■ Inserts

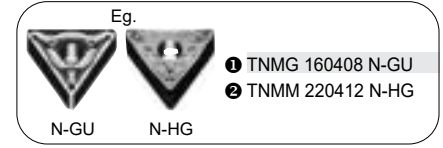

### ■ Spare Parts

Wedge	Shim pin	Shim	Clamp bolt	Nut	Ring	Wrench	Insert
MMW30	MP317 MP320	STW323	BHA0525 4,0 <sub>(mm)</sub>	CPM32N	ER04	LH030	1
MMW40	MP420	STW434	BHA0625 4,5 <sub>(mm)</sub>	CPM43N	ER05	LH030 LH040	2

### ■ Inserts

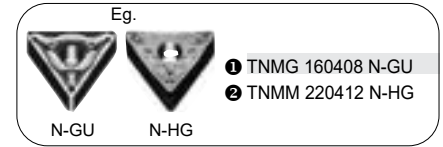

### ■ Spare Parts

Wedge	Shim pin	Shim	Clamp bolt	Nut	Ring	Wrench	Insert
MMW30	MP317 MP320	STW323	BHA0525 4,0 <sub>(mm)</sub>	CPM32N	ER04	LH030	1
MMW40	MP420	STW434	BHA0625 4,5 <sub>(mm)</sub>	CPM43N	ER05	LH030, 040	2

# External Tool Holders M Type (Wedge Clamp)

## Tool Holders for neg. Inserts WN

### General Turning and Facing

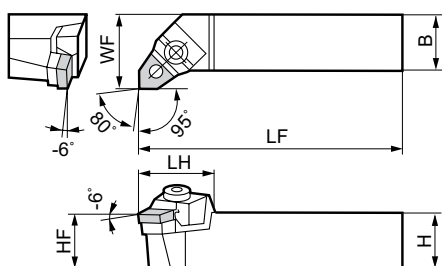
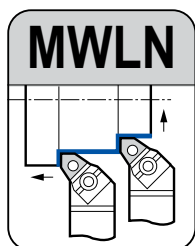

### ■ Inserts

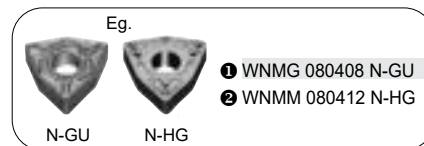

### ■ Spare Parts

Cat. No.	Stock		Dimensions (mm)							Wedge	Shim pin	Shim	Clamp bolt	Nut	Ring	Wrench	Insert
	R	L	H	HF	B	LF	LH	WF									
MWLN R/L 2020-43 (K08)	●	●	20	20	20	125	32	25		MWW40	MP416	SWW433	BHA0625	CPM43S		LH030	1, 2
MWLN R/L 2525-43 (M08)	●	●	25	25	25	150	32	32			MP420		4,5 <sup>mm</sup>	CPM43N	ER04	LH040	
MWLN R/L 3225-43 (P08)	○	○	32	32	25	170	32	32									

### ■ Holders

Above figures show right hand tools.

### P Type Lever Lock Holders

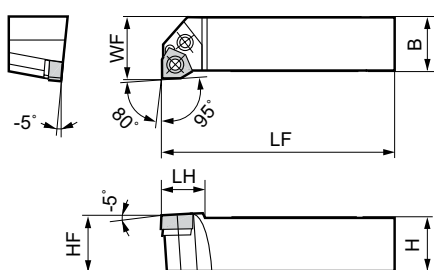
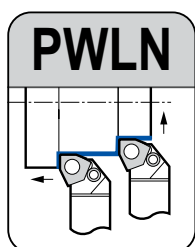

### ■ Inserts



### ■ Spare Parts

Cat. No.	Stock		Dimensions (mm)							Lever pin	Clamp bolt	Shim	Shim pin	Wrench	Insert
	R	L	H	HF	B	LF	LH	WF							
PWLN R/L 2020 K06 (PWLN R/L 2020-33)	●	○	20	20	20	125	27	25		LCL3SD	LCS3TB-SD	LSW317	LSP3SD	LH025	1
PWLN R/L 2525 M06	●		25	25	25	150	27	32							

### ■ Holders

Above figures show right hand tools.

# External Tool Holders for Solid SUMIBORON

## C Type Top Clamp Holders

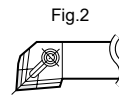
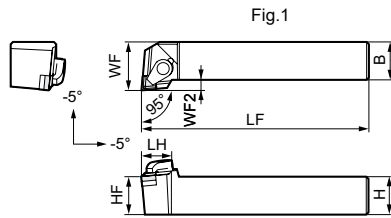
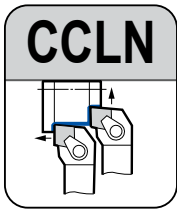

### Inserts

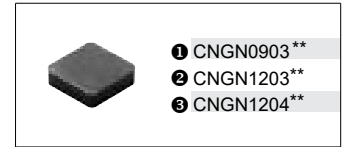

### Holdings

Above figures show right hand tools.

Cat. No.	Stock		Dimensions (mm)								Fig.	Clamp	Insert protector	Clamp bolt	Shim	Shim pin	Wrench	Insert
	R	L	H	HF	B	LF	LH	WF	WF2									
CCLN R/L 2525 M09			25	25	25	150	25	32	7	1	CCM8UL	CBC0903	WB8-22T	SSCN0903	SPP3	LT27		1
CCLN R/L 2525 M12-03			25	25	25	150	30	32	7	1	CCM8UL	CBC4	WB8-22T	SSCN433	SPP3	LT27		2
CCLN R/L 2525 M12-04			25	25	25	150	30	32	7	2	CCM8-LONG	CBC4	WB8-30	SSCN433	SPP3	LH040		3

### Spare Parts

Clamp	Insert protector	Clamp bolt	Shim	Shim pin	Wrench	Insert

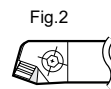
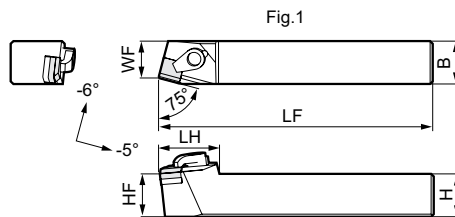
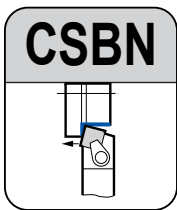

### Inserts



### Holdings

Above figures show right hand tools.

Cat. No.	Stock		Dimensions (mm)								Fig.	Clamp	Insert protector	Clamp bolt	Shim	Shim pin	Spring	Wrench	Insert
	R	L	H	HF	B	LF	LH	WF	WF2										
CSBN R/L 2525 N09			25	25	25	160	30	21,5	-	1	CCM8UL	CBS13	WB8-22T	SSN0903	-	-	LH040		1
CSBN R/L 2525 N12-03			25	25	25	160	35	21,5	-	1	CCM8UL	CBS14	WB8-22T	SSND423	-	-	LH040		2
CSBN R/L 2525 N12-04			25	25	25	160	33	21,5	-	2	DC-RL1	CBD 4 RL	BH 0830 RL	SSND423	SPP3	DSP5	LH040		3

### Spare Parts

Clamp	Insert protector	Clamp bolt	Shim	Shim pin	Spring	Wrench	Insert

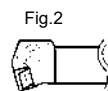
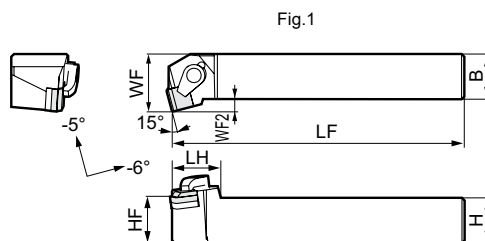
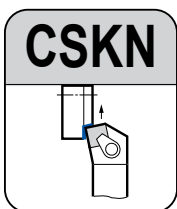

### Inserts



### Holdings

Above figures show right hand tools.

Cat. No.	Stock		Dimensions (mm)								Fig.	Clamp	Insert protector	Clamp bolt	Shim	Shim pin	Spring	Wrench	Insert
	R	L	H	HF	B	LF	LH	WF	WF2										
CSKN R/L 2525 N09			25	25	25	160	25	32	7	1	CCM8UL	CBS13	WB8-22T	SSN0903	-	-	LH040		1
CSKN R/L 2525 N12-03			25	25	25	160	25	32	7	1	CCM8UL	CBS14	WB8-22T	SSND423	-	-	LH040		2
CSKN R/L 2525 N12-04			25	25	25	160	21	32	7	2	DC-RL1	CBD 4 RL	BH 0830 RL	SSND423	SPP3	DSP5	LH040		3

### Spare Parts

Clamp	Insert protector	Clamp bolt	Shim	Shim pin	Spring	Wrench	Insert

External Holders for neg. Inserts



# External Tool Holders for Solid SUMIBORON

## C Type Top Clamp Holders

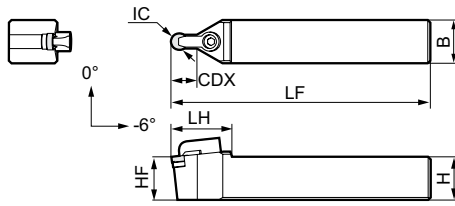
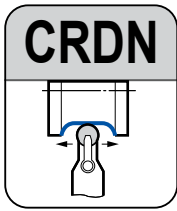

### ■ Inserts



### ■ Holders

Cat. No.	Stock	Dimensions (mm)						
		H	HF	B	LF	LH	WF	CDX
CRDNN 2525 M09	●	25	25	25	150	35	-	15
CRDNN 2525 M12-03		25	25	25	150	35	-	20
CRDNN 2525 M12-04	●	25	25	25	150	35	-	20

### ■ Spare Parts

Clamp	Double screw	Shim	Shim pin	Wrench	Insert
CCM8-LONG	WB8-22T	SRND32	SPP3	LT27	1
		SRND42			2
					3

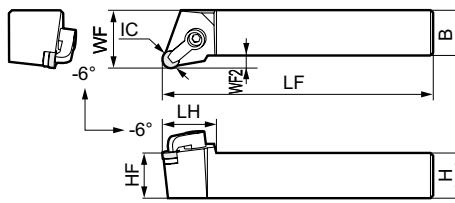
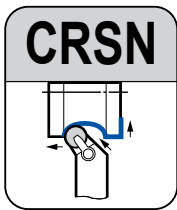

### ■ Inserts



### ■ Holders

Above figures show right hand tools.

Cat. No.	Stock		Dimensions (mm)						
	R	L	H	HF	B	LF	LH	WF	WF2
CRSN R/L 2525 M09	●	●	25	25	25	150	30	32	7
CRSN R/L 2525 M12-03			25	25	25	150	30	32	7
CRSN R/L 2525 M12-04	●	●	25	25	25	150	30	32	7

### ■ Spare Parts

Clamp	Double screw	Shim	Shim pin	Wrench	Insert
CCM8-LONG	WB8-22T	SRND32	SPP3	LT27	1
		SRND42			2
					3

## X Type Dimple Lock Holders

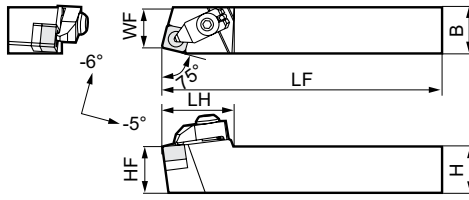
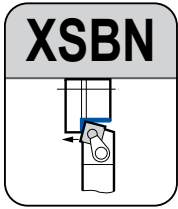

### ■ Inserts



### ■ Spare Parts

Cat. No.		Stock	Dimensions (mm)							Clamp	Clamp bolt	Shim	Shim pin	Spring	Wrench	Insert
R	L	H	HF	B	LF	LH	WF									
			25	25	25	160	38	21,5	DSLX8	BH0825	SSND423	SPP3	GSP10	LH050		①

### ■ Holders

Above figures show right hand tools.

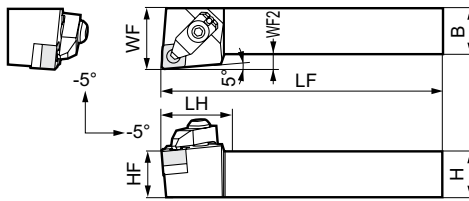
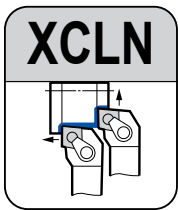

### ■ Inserts



### ■ Spare Parts

### ■ Holders

Above figures show right hand tools.

Cat. No.		Stock	Dimensions (mm)							Clamp	Clamp bolt	Shim	Shim pin	Spring	Wrench	Insert
R	L	H	HF	B	LF	LH	WF	WF2								
			25	25	25	150	33	32	7	DSLX8	BH0825	SCND433	SPP3	GSP10	LH050	①

# External Mini Holders

External Holders  
for pos. Inserts

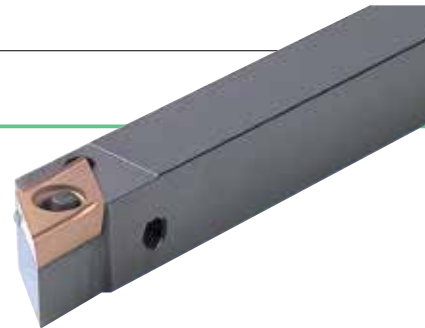

## Back-Turning Tool Holder SBT Type

Sharp cutting edges with good surface finish.  
Max. reach of insert 8,0 mm, edge width 2,5 mm



## Cut-off Tool Holder SCT Type

Easy insert change by just loosening the screw  
from the back.

Max. cut-off dia.  $\varnothing$  5 mm,  $\varnothing$  12 mm,  $\varnothing$  16 mm



PDJCR type  
lever lock holder

Wear-resistant tool materials;  
**T1500A** (Cermet) and  
**AC530U** (2000 layers  
coated carbide grade)

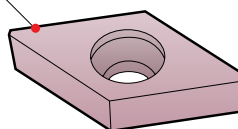

Sharp cutting edge  
(RE = 0,03  
0,1 and 0,2 mm)

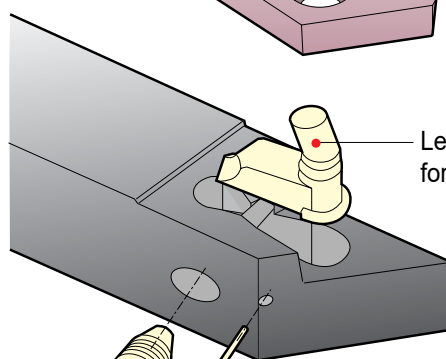

Lever lock clamping  
for 7° positive inserts

Easy access  
side locking screw

# External Mini Holders

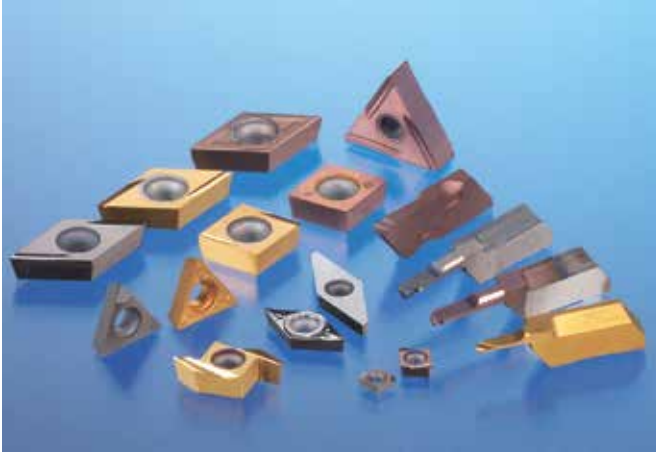

In 1984, Sumitomo Electric Hardmetal first released the Mini Tool Holder series for the machining of small components in small NC autolathes.

A full range of insert grades comprising of the Cermet T1500A, SUMIBORON BN2000, SUMIDIA DA1000 and especially AC530U, was also introduced to meet a variety of machining requirements.

External Holders  
for pos. Inserts

## Grade Selection

Category	Application Range			Work Material					
	High Precision	Finish-Light Cut	Medium Cut	P General Steel	M Stainless Steel	K Cast Iron	S Heat Resistant Alloy	H Hardened Steel	N Non-Ferrous Metal
Coated Carbide (PVD)	ACZ150			⊙	⊙				○
	AC5015S			○	⊙	○	⊙		
	AC5025S			○	⊙	○	⊙		
	AC530U			⊙	⊙	○	○		○
	AC1030U			⊙	⊙	○	○		○
Cermet/Coated Cermet	T1000A			⊙	○	⊙			○
	T1500A / T1500Z			⊙	○	○			○
Carbide	BL130			○	○	○			○
	H1			○	○	○	○		⊙
	EH510			○	○	○	⊙		○
CBN (SUMIBORON)	BN1000 / BN2000							⊙	
	BN7000					⊙	○		
SUMIDIA	DA1000								⊙

⊙ Preferred Choice      ○ Suitable

## Recommended Cutting Conditions

Work Material	P Free Cutting Steel		P Carbon Steel		M Stainless Steel		S Heat Resistant Alloy		H Hardened Steel		N Aluminium		N Brass	
	v <sub>c</sub> (m/min)	f (mm/rev)	v <sub>c</sub> (m/min)	f (mm/rev)	v <sub>c</sub> (m/min)	f (mm/rev)	v <sub>c</sub> (m/min)	f (mm/rev)	v <sub>c</sub> (m/min)	f (mm/rev)	v <sub>c</sub> (m/min)	f (mm/rev)	v <sub>c</sub> (m/min)	f (mm/rev)
ACZ150	50-200	0,02-0,10	50-150	0,01-0,08	50-150	0,01-0,05					70-300	0,05-0,20	70-300	0,05-0,20
AC5015S	50-200	0,02-0,15	50-200	0,02-0,10	*50-200	*0,02-0,10							70-300	0,05-0,20
AC5025S	50-200	0,02-0,15	50-200	0,02-0,10	*50-200	*0,02-0,10	30-100	0,02-0,10					70-300	0,05-0,20
AC530U	50-200	0,02-0,15	50-200	0,02-0,10	*50-200	*0,02-0,10	30-100	0,02-0,10					70-300	0,05-0,20
AC1030U	50-200	0,02-0,15	50-200	0,02-0,10	*50-200	*0,02-0,10							70-300	0,05-0,20
T1000A	50-200	0,02-0,15	50-200	0,02-0,10	*50-150	*0,02-0,10					70-300	0,05-0,20	70-300	0,05-0,20
T1500A	50-200	0,02-0,15	50-200	0,02-0,10	*50-150	*0,02-0,10					70-300	0,05-0,20	70-300	0,05-0,20
T1500Z	50-200	0,02-0,15	50-200	0,02-0,10	*50-150	*0,02-0,10					70-300	0,05-0,20	70-300	0,05-0,20
BN1000									120-300	0,03-0,15				
BN2000									50-200	0,03-0,20				
BN7000							50-200	0,05-0,20						
DA1000											70-300	0,02-0,10	70-300	0,02-0,10

\* Please use maximal possible C/speed

# External Mini Tool Holders SBT Type

## Special Mini Holders for Back Facing

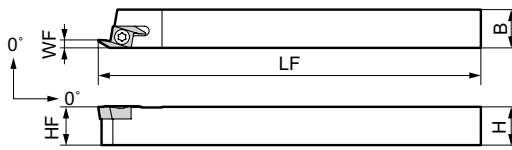
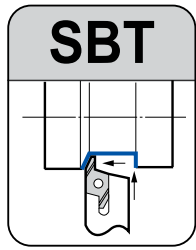
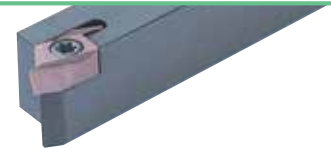

SBT35 R1010:

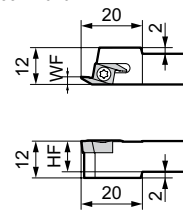

### ■ Spare Parts

### ■ Holders

Above figures show right hand tools.

Cat. No.	Stock	Dimensions (mm)						Screw	Wrench	Insert	
		H	HF	B	LF	WF					
SBT 35-R 1010	●	10	10	10	120	7,5					
SBT 35-R 1212	●	12	12	12	120	9,5		BFTX0307N	2,0	TRX10	BTR 35_ _
SBT 35-R 1616	●	16	16	16	120	13,5					

### ■ Inserts

Coated carbide

Uncoated Cermet

BTR	Cat. No.	Stock			Dimensions (mm)			
		AC1030U	AC530U	T1500A	L	CDX	CW	RE
	BTR 3505	○	○	○	15	3,5	2,5	0,05
	BTR 3515	○	○	○	15	3,5	2,5	0,15

Sharp cutting edge with 15° rake angle

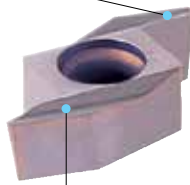

Wide groove breaker for smooth chip evacuation

### ● Surface roughness comparison

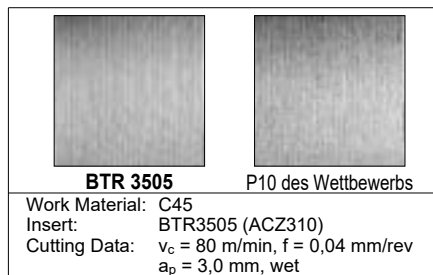

### ■ Recommended Cutting Data (SBT type)

Work Material	Tooling	v <sub>c</sub> (m/min)	f (mm/rev)
General steel	Grooving	50–150	0,02–0,05
	Back facing		0,02–0,10
Free-cutting steel	Grooving	50–150	0,02–0,10
	Back facing		0,02–0,15
Stainless steel	Grooving	50–150	0,02–0,04
	Back facing		0,02–0,06

● = Euro stock  
○ = Japan stock

Recommended Tightening Torque (N·m)

## P Type Lever Lock Holders

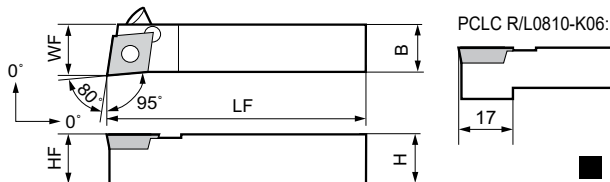
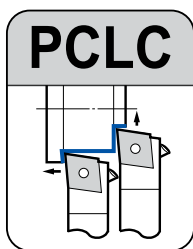
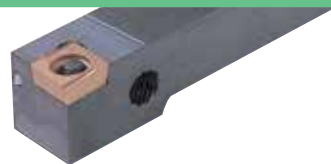

### Inserts

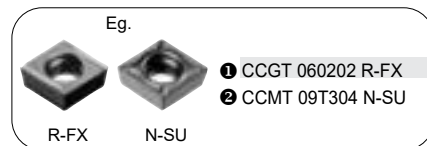

### ■ Holders

Above figures show right hand tools.

Cat. No.	Stock		Dimensions (mm)							Lever pin	Clamp screw	Side pin	Wrench	Insert
	R	L	H	HF	B	LF	WF							
PCLC R/L 0810 K06			8	8	10	125	10,5			LCL 06	BTT 0407	LP 07	TH 020	1
PCLC R/L 1010 K06	●	○	10	10	10	125	10,5					LP 06		2
PCLC R/L 1212 K09	●	●	12	12	12	150	12,5			LCL 09	BTT 0411			
PCLC R/L 1616 K09	●		16	16	16	150	16,5							

## S Type Screw Lock Holders

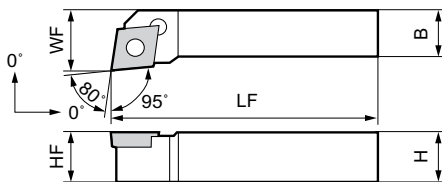
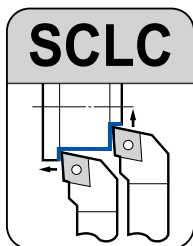

### ■ Inserts

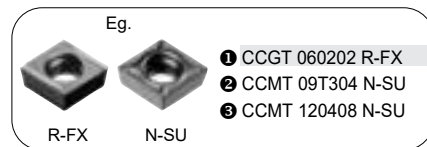

### ■ Holders

Above figures show right hand tools.

Cat. No.	Stock		Dimensions (mm)							Screw	Wrench	Insert	
	R	L	H	HF	B	LF	WF						
SCLC R/L 0808 D06			8	8	8	60	10			BFTX02506N	1,5	TRX08	1
SCLC R/L 1010 E06	●	●	10	10	10	70	12						
SCLC R/L 1212 F09	●	●	12	12	12	80	16			BFTX0409N	3,4	TRX15	2
SCLC R/L 1616 H09	●	●	16	16	16	100	20						
SCLC R/L 2020 H09	●		20	20	20	100	25			BFTX0511N	5,0	TRX20	3
SCLC R/L 2020 K09	●	●	20	20	20	125	25						
SCLC R/L 2525 M12	●	●	20	25	25	150	32						

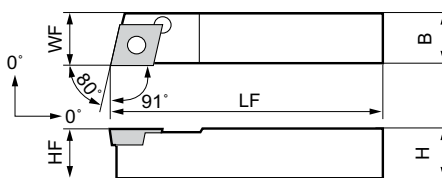
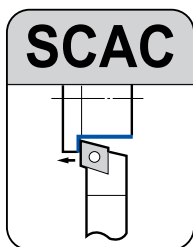

### ■ Inserts

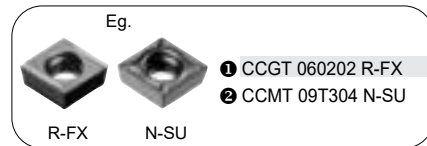

### ■ Holders

Above figures show right hand tools.

Cat. No.	Stock		Dimensions (mm)							Screw	Wrench	Insert	
	R	L	H	HF	B	LF	WF						
SCAC R/L 0808 D06			8	8	8	60	8,5			BFTX02506N	1,5	TRX08	1
SCAC R/L 1010 E06	●		10	10	10	70	10,5						
SCAC R/L 1212 F09	●		12	12	12	80	12,5			BFTX0409N	3,4	TRX15	2



# External Mini Tool Holders PD/SD Type

Mini Holders for 7° DC \_\_\_ pos. Inserts



## P Type Lever Lock Holders

### ■ Inserts

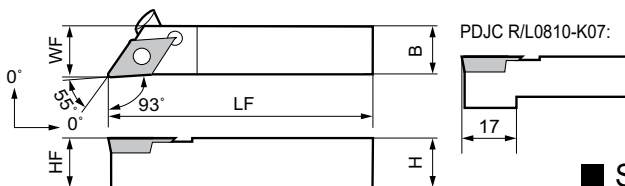
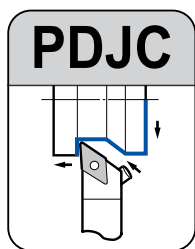

### ■ Spare Parts

### ■ Holders

Above figures show right hand tools.

Cat. No.	Stock		Dimensions (mm)							Lever pin	Clamp screw	Side pin	Wrench	Insert
	R	L	H	HF	B	LF	WF							
PDJC R/L 0810 K07	●		8	8	10	125	10,5			LCL 06	BTT 0407	LP 04	TH 020	1
PDJC R/L 1010 K07	●	●	10	10	10	125	10,5			LCL 09		LP 07		2
PDJC R/L 1212 M11	●	●	12	12	12	150	12,5				BTT 0411			
PDJC R/L 1616 M11	●	○	16	16	16	150	16,5							

## S Type Screw Lock Holders

### ■ Inserts

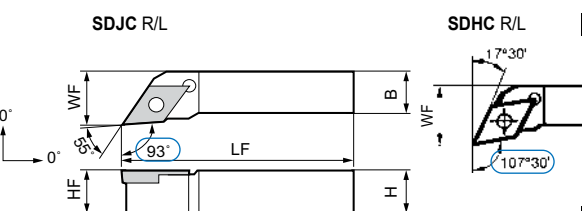
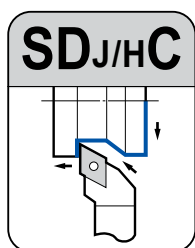

### ■ Spare Parts

### ■ Holders

Above figures show right hand tools.

Cat. No.	Stock		Dimensions (mm)							Screw	Nm	Wrench	Insert
	R	L	H	HF	B	LF	WF						
SDJC R/L 1010 E07	●		10	10	10	70	12			BFTX02506N	1,5	TRX08	1
SDJC R/L 1212 F07	●	●	12	12	12	80	16						
SDJC R/L 1616 H07	●	●	16	16	16	100	20						
SDJC R/L 2020 K07	●	●	20	20	20	125	25						
SDJC R/L 1212 F11	●	●	12	12	12	80	16			BFTX0409N	3,4	TRX15	2
SDJC R/L 1616 H11	●	●	16	16	16	100	20						
SDJC R/L 2020 K11	●	●	20	20	20	125	25						
SDJC R/L 2525 M11	●	●	25	25	25	150	32						
SDHC R/L 1616 H11	●	●	16	16	16	100	20			BFTX0409N	3,4	TRX15	2
SDHC R/L 2020 K11	●	●	20	20	20	125	25						
SDHC R/L 2525 M11	●	●	25	25	25	150	32						

External Holders for pos. Inserts

## S Type Screw Lock Holders

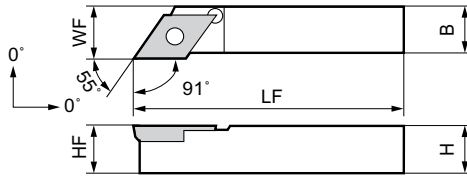
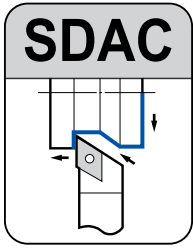

### ■ Holders

Above figures show right hand tools.

Cat. No.	Stock		Dimensions (mm)							Screw	N·m	Wrench	Insert
	R	L	H	HF	B	LF	WF						
SDAC R/L 0808 D07			8	8	8	60	8,5			BFTX02506N	1,5	TRX08	①
SDAC R/L 1010 E07	●		10	10	10	70	10,5						
SDAC R/L 1212 F11	●	●	12	12	12	80	12,5			BFTX0409N	3,4	TRX15	②

### ■ Inserts

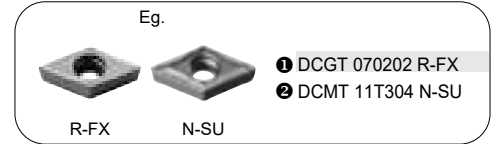

### ■ Spare Parts

Screw	N·m	Wrench	Insert
BFTX02506N	1,5	TRX08	①
BFTX0409N	3,4	TRX15	②

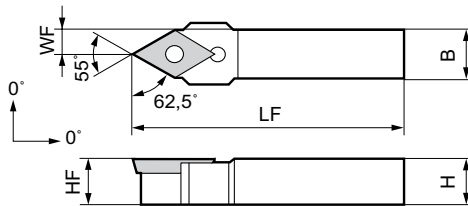
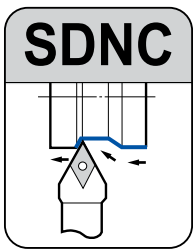

### ■ Holders

Cat. No.	Stock	Dimensions (mm)							Screw	N·m	Wrench	Insert
		H	HF	B	LF	WF						
SDNCN 0808 D07	●	8	8	8	60	4,2			BFTX02506N	1,5	TRX08	①
SDNCN 1010 E07	●	10	10	10	70	5,2						
SDNCN 1212 F07	●	12	12	12	80	6,2			BFTX0409N	3,4	TRX15	②
SDNCN 1616 H07		16	16	16	100	8,2						
SDNCN 2020 K07	●	20	20	20	125	10,2			BFTX0409N	3,4	TRX15	②
SDNCN 1212 F11	●	12	12	12	80	6,5						
SDNCN 1616 H11	●	16	16	16	100	8,5			BFTX0409N	3,4	TRX15	②
SDNCN 2020 K11	●	20	20	20	125	10,5						
SDNCN 2525 M11	●	25	25	25	150	13						

### ■ Inserts



### ■ Spare Parts

Screw	N·m	Wrench	Insert
BFTX02506N	1,5	TRX08	①
BFTX0409N	3,4	TRX15	②

External Holders  
for pos. Inserts

# External Tool Holders PR Type

External Holders for 7° RC \_\_\_ pos. Inserts



## P Type Lever Lock Holders

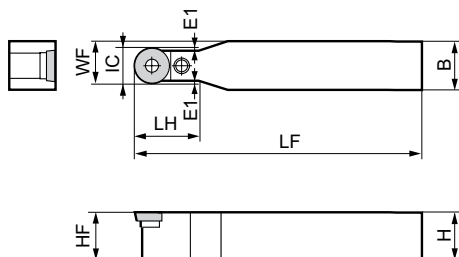
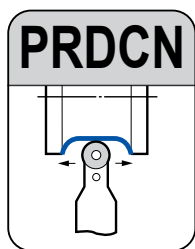

### ■ Inserts

Eg.

N-RP

- ① RCOO1003M0 N-RO
- ② RCOO1204M0 N-RO
- ③ RCOO1606M0 N-RO
- ④ RCOO2006M0 N-RO

### ■ Spare Parts

						Insert
	LCL10	LCS10	LSR10	LSP10	LH020	①
	LCL12	LCS12	LSR12	LSP10	LH025	②
	LCL16	LCS16	LSR16	LSP16	LH025	③
	LCL20	LCS20	LSR20	LSP20	LH030	④

### ■ Holders

Cat. No.	Stock	Dimensions (mm)								Lever pin	Clamp screw	Shim	Shim pin	Wrench	Insert
		H	HF	B	LF	LH	WF	E1	IC						
PRDC N 2020 M10	●	20	20	20	150	22	15,0	1,0	10	LCL10	LCS10	LSR10	LSP10	LH020	①
PRDC N 2525 M10	●	25	25	25	150	22	17,5	1,0	10	LCL10	LCS10	LSR10	LSP10	LH020	①
PRDC N 2525 M12	●	25	25	25	150	24	18,5	1,2	12	LCL12	LCS12	LSR12	LSP10	LH025	②
PRDC N 3225 Q12	●	32	32	25	180	24	18,5	1,2	12	LCL12	LCS12	LSR12	LSP10	LH025	②
PRDC N 3225 Q16	●	32	32	25	180	28	20,5	1,5	16	LCL16	LCS16	LSR16	LSP16	LH025	③
PRDC N 3232 Q20	●	32	32	32	180	32	26,5	1,7	20	LCL20	LCS20	LSR20	LSP20	LH030	④

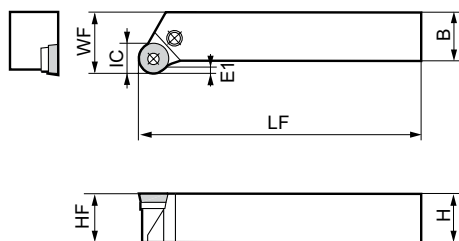
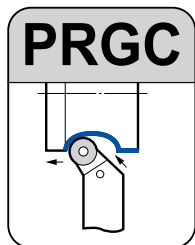

### ■ Inserts

Eg.

N-RP

- ① RCOO 1003M0 N-RO
- ② RCOO 1204M0 N-RO
- ③ RCOO 1606M0 N-RO
- ④ RCOO 2006M0 N-RO

### ■ Spare Parts

						Insert
	LCL10	LCS10	LSR10	LSP10	LH020	①
	LCL12	LCS12	LSR12	LSP10	LH025	②
	LCL16	LCS16	LSR16	LSP16	LH025	③
	LCL20	LCS20	LSR20	LSP20	LH030	④

### ■ Holders

Above figures show right hand tools.

Cat. No.	Stock		Dimensions (mm)								Lever pin	Clamp screw	Shim	Shim pin	Wrench	Insert
	R	L	H	HF	B	LF	WF	E1	IC							
PRGC R/L 2020 K10	●		20	20	20	125	25	1,5	10	LCL10	LCS10	LSR10	LSP10	LH020	①	
PRGC R/L 2525 M10	●	●	25	25	25	150	32	1,5	10	LCL10	LCS10	LSR10	LSP10	LH020	①	
PRGC R/L 2020 K12			20	20	20	125	25	2,5	12	LCL12	LCS12	LSR12	LSP10	LH025	②	
PRGC R/L 2525 M12	○	●	25	25	25	150	32	2,5	12	LCL12	LCS12	LSR12	LSP10	LH025	②	
PRGC R/L 3225 P12			32	32	25	170	32	2,5	12	LCL12	LCS12	LSR12	LSP10	LH025	②	
PRGC R/L 2525 M16	●		25	25	25	150	32	3,0	16	LCL16	LCS16	LSR16	LSP16	LH025	③	
PRGC R/L 3225 P16	●		32	32	25	170	32	3,0	16	LCL16	LCS16	LSR16	LSP16	LH025	③	
PRGC R/L 3232 P20	●		32	32	32	170	40	4,0	20	LCL20	LCS20	LSR20	LSP20	LH030	④	

● = Euro stock  
○ = Japan stock

Recommended Tightening Torque (N·m)

## S Type Screw Lock Holders

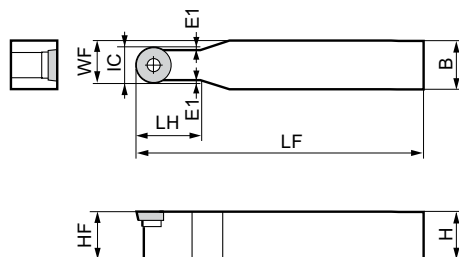
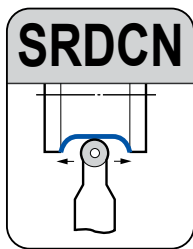

### ■ Holders

Cat. No.	Stock	Dimensions (mm)								Screw	Shim	Screw	Wrench	Wrench	Insert
		H	HF	B	LF	LH	WF	E1	IC						
SRDC N 2020 K10T3	●	20	20	20	125	25	15,0	1,0	10	BFTX03510-SD	SRNS 103-SD	BW 0508F-SD	TRX 15 IP-35	LH 035	①
SRDC N 2525 M10T3	●	25	25	25	150	25	17,5	1,0	10	2,0 $\text{C}_{\text{min}}$	SRNS 123-SD				
SRDC N 2525 M12	●	25	25	25	150	28	18,5	1,2	12	BFTX03512-SD	SRNS 123-SD	BW 0810F-SD	LT 20 IP	LH 050	②
SRDC N 3225 P12	●	32	32	25	170	28	18,5	1,2	12	2,0 $\text{C}_{\text{min}}$	SRNS 164-SD				
SRDC N 2525 M16	●	25	25	25	150	35	20,5	1,5	16	BFTX0517-SD	SRNS 164-SD	BW 0912F-SD	LT 25 IP	LH 060	③
SRDC N 3225 P16	●	32	32	25	170	35	20,5	1,5	16	5,0 $\text{C}_{\text{min}}$	SRNS 204-SD				
SRDC N 3232 P20	●	32	32	32	170	40	26,0	1,7	20	BFTX0618-SD 7,5 $\text{C}_{\text{min}}$	SRNS 204-SD				

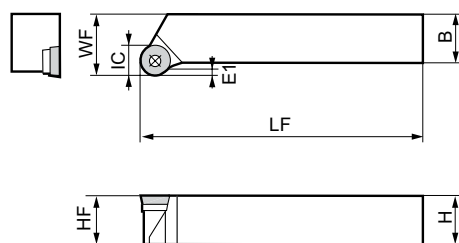
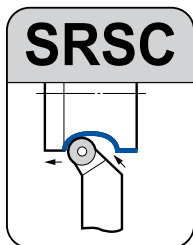

### ■ Holders

Cat. No.	Stock		Dimensions (mm)								Screw	Shim	Screw	Wrench	Wrench	Insert
	R	L	H	HF	B	LF	WF	E1	IC							
SRSC R/L 2020 K10T3	●	●	20	20	20	125	25	1,5	10	BFTX 03510-SD	SRNS 103-SD	BW 0508F-SD	TRX 15 IP-35	LH 035	①	
SRSC R/L 2525 M10T3	●	●	25	25	25	150	32	1,5	10	2,0 $\text{C}_{\text{min}}$	SRNS 123-SD					
SRSC R/L 2525 M12	●	●	25	25	25	150	32	2,5	12	BFTX 03512-SD	SRNS 123-SD	BW 0810F-SD	LT 20 IP	LH 050	②	
SRSC R/L 3225 P12	●	●	32	32	25	170	32	2,5	12	2,0 $\text{C}_{\text{min}}$	SRNS 164-SD					
SRSC R/L 3225 P16	●	●	32	32	25	170	32	3,0	16	BFTX 0517-SD 5,0 $\text{C}_{\text{min}}$	SRNS 164-SD	BW 0912F-SD	LT 25 IP	LH 060	③	
SRSC R/L 3232 P20	●	●	32	32	32	170	40	4,0	20	BFTX 0618-SD 7,5 $\text{C}_{\text{min}}$	SRNS 204-SD					

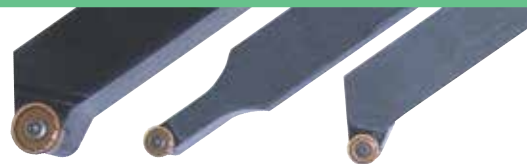

### ■ Inserts

Eg.



N-RX

- RCO01003M0
- ① RCO010T3M0 N-R0
- ② RCO01204M0 N-R0
- ③ RCO01606M0 N-R0
- ④ RCO02006M0 N-R0

### ■ Spare Parts

Screw	Shim	Screw	Wrench	Wrench	Insert
BFTX03510-SD	SRNS 103-SD	BW 0508F-SD	TRX 15 IP-35	LH 035	①
BFTX03512-SD	SRNS 123-SD	BW 0810F-SD	LT 20 IP	LH 050	②
BFTX0517-SD	SRNS 164-SD	BW 0912F-SD	LT 25 IP	LH 060	③
BFTX0618-SD 7,5 $\text{C}_{\text{min}}$	SRNS 204-SD	BW 0912F-SD	LT 25 IP	LH 060	④

### ■ Inserts

Eg.



N-RX

- RCO01003M0
- ① RCO010T3M0 N-R0
- ② RCO01204M0 N-R0
- ③ RCO01606M0 N-R0
- ④ RCO02006M0 N-R0

### ■ Spare Parts

Screw	Shim	Screw	Wrench	Wrench	Insert
BFTX 03510-SD	SRNS 103-SD	BW 0508F-SD	TRX 15 IP-35	LH 035	①
BFTX 03512-SD	SRNS 123-SD	BW 0810F-SD	LT 20 IP	LH 050	②
BFTX 0517-SD 5,0 $\text{C}_{\text{min}}$	SRNS 164-SD	BW 0912F-SD	LT 25 IP	LH 060	③
BFTX 0618-SD 7,5 $\text{C}_{\text{min}}$	SRNS 204-SD	BW 0912F-SD	LT 25 IP	LH 060	④

External Holders  
for pos. Inserts

# External Mini Tool Holders SS Type

Mini Holders for 7° SC\_\_ pos. Inserts

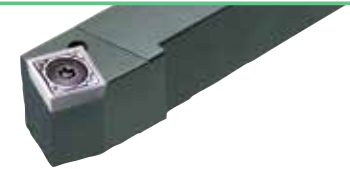

## S Type Screw Lock Holders

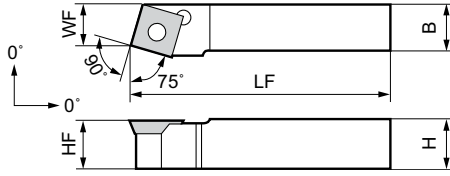
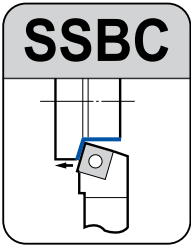

### ■ Inserts



### ■ Spare Parts

### ■ Holders

Above figures show right hand tools.

Cat. No.	Stock		Dimensions (mm)							Screw	⌚ (N·m)	Wrench	Insert
	R	L	H	HF	B	LF	WF						
SSBC R/L 1010 E07			10	10	10	70	9			BFTX0307N	2,0	TRX10	①
SSBC R/L 1212 F09			12	12	12	80	11			BFTX0409N	3,4	TRX15	②
SSBC R/L 1616 H09	●	●	16	16	16	100	13			BFTX0511N	5,0	TRX20	③
SSBC R/L 2020 K12			20	20	20	125	17						
SSBC R/L 2525 M12			25	25	25	150	22						

External Holders for pos. Inserts

## S Type Screw Lock Holders

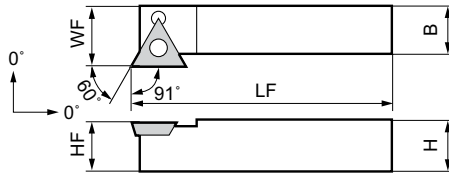
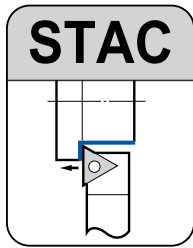

### ■ Holders

Above figures show right hand tools.

Cat. No.	Stock		Dimensions (mm)							Screw	Nm	Wrench	Insert
	R	L	H	HF	B	LF	WF						
STAC R/L 0808 D09			8	8	8	60	8,5			BFTX02205N	1,1	TRX06	①
STAC R/L 1212 F11	●		12	12	12	80	12,5			BFTX02506N	1,5	TRX08	②

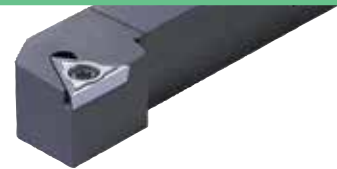

### ■ Inserts

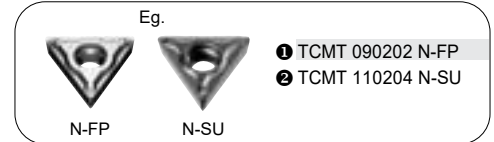

### ■ Spare Parts

Screw	Nm	Wrench	Insert
BFTX02205N	1,1	TRX06	①
BFTX02506N	1,5	TRX08	②

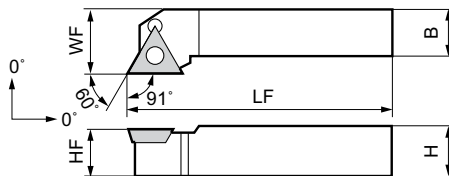
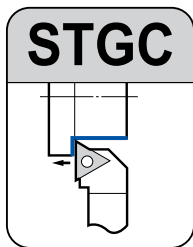

### ■ Holders

Above figures show right hand tools.

Cat. No.	Stock		Dimensions (mm)							Screw	Nm	Wrench	Insert
	R	L	H	HF	B	LF	WF						
STGC R/L 0808 D09			8	8	8	60	10			BFTX02205N	1,1	TRX06	①
STGC R/L 1010 E09	●		10	10	10	70	12			BFTX02506N	1,5	TRX08	②
STGC R/L 1212 F11	●		12	12	12	80	16						
STGC R/L 1616 H11	●	●	16	16	16	100	20			BFTX0409N	3,4	TRX15	③
STGC R/L 1616 H16	●	●	16	16	16	100	20						
STGC R/L 2020 K16	●	●	20	20	20	125	25						
STGC R/L 2525 M16			25	25	25	150	32						

### ■ Inserts

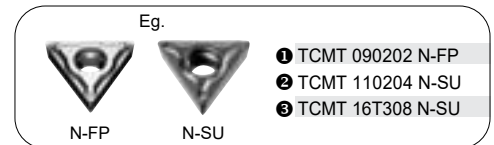

### ■ Spare Parts

Screw	Nm	Wrench	Insert
BFTX02205N	1,1	TRX06	①
BFTX02506N	1,5	TRX08	②
BFTX0409N	3,4	TRX15	③

External Holders  
for pos. Inserts



# External Mini Tool Holders SV Type

Mini Holders for 5° VB      pos. Inserts

## S Type Screw Lock Holders

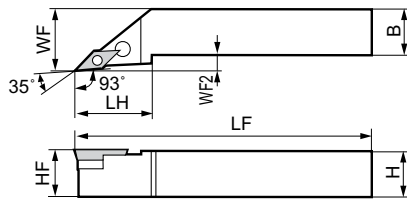
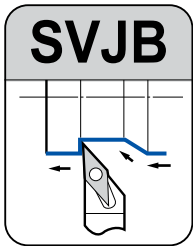
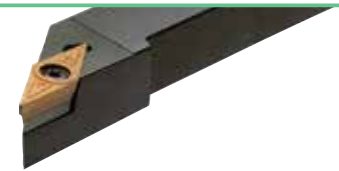

### ■ Inserts



### ■ Spare Parts

Cat. No.	Stock		Dimensions (mm)							Stopper	Nut	Shim	Wrench	ScREW	Wrench	Insert
	R	L	H	HF	B	LF	LH	WF	WF2							
SVJB R/L 1212 F11	●	●	12	12	12	80	25	16	4,5	-	-	-	-	BFTX02508NV 1,5 <sup>(N-m)</sup>	TRX08	1
SVJB R/L 1616 H11	●	●	16	16	16	100	25	20	4,5	-	-	-	-	BFTX03508	TRX10	2
SVJB R/L 2020 K16	●	●	20	20	20	125	41	25	5,0	VP20	-	-	-	BFTX03508	TRX10	2
SVJB R/L 2525 M16	●	●	25	25	25	150	41	32	7,0	VP25	CPV33N	SVP32	LH025	BFTX03508	TRX10	2
SVJB R/L 3225 P16	●	●	32	32	25	170	41	32	7,0	VP32	-	-	-	2,0 <sup>(N-m)</sup>	-	-

### ■ Holders

Above figures show right hand tools.

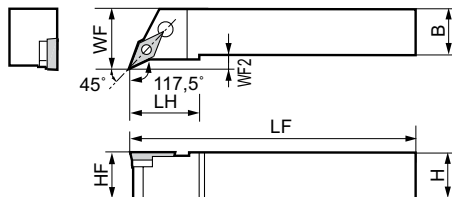
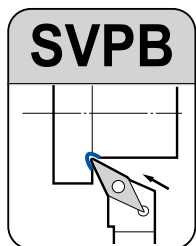

### ■ Inserts



### ■ Spare Parts

Cat. No.	Stock		Dimensions (mm)							Stopper	Nut	Shim	Wrench	ScREW	Wrench	Insert
	R	L	H	HF	B	LF	LH	WF	WF2							
SVPB R/L 1212 F11	●	○	12	12	12	80	25	16	4,5	-	-	-	-	BFTX02508NV 1,5 <sup>(N-m)</sup>	TRX08	1
SVPB R/L 1616 H11	●	●	16	16	16	100	25	20	4,5	-	-	-	-	BFTX03508	TRX10	2
SVPB R/L 2020 K16	●	●	20	20	20	125	36	25	5,0	VP20	-	-	-	BFTX03508	TRX10	2
SVPB R/L 2525 M16	●	●	25	25	25	150	36	32	7,0	VP25	CPV33N	SVP32	LH025	BFTX03508	TRX10	2
SVPB R/L 3225 P16	●	●	32	32	25	170	36	32	7,0	VP32	-	-	-	2,0 <sup>(N-m)</sup>	-	-

### ■ Holders

Above figures show right hand tools.

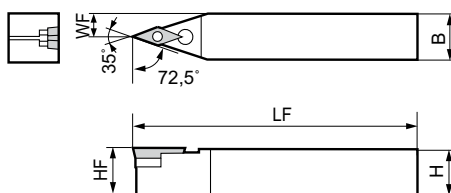
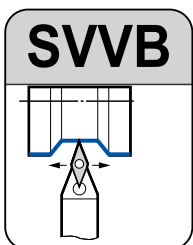

### ■ Inserts



### ■ Spare Parts

Cat. No.	Stock		Dimensions (mm)							Stopper	Nut	Shim	Wrench	ScREW	Wrench	Insert
	H	HF	B	LF	LH	WF										
SVVB M 1212 F11	●	○	12	12	12	80	-	6	-	-	-	-	-	BFTX02508NV 1,5 <sup>(N-m)</sup>	TRX08	1
SVVB N 1616 H11	●	○	16	16	16	100	-	8	-	-	-	-	-	BFTX03508	TRX10	2
SVVB N 2020 K16	●	○	20	20	20	125	-	10	-	VP20	-	-	-	BFTX03508	TRX10	2
SVVB N 2525 M16	●	○	25	25	25	150	-	12,5	-	VP25	CPV33N	SVP32	LH025	BFTX03508	TRX10	2
SVVB N 3225 P16	●	○	32	32	25	170	-	12,5	-	VP32	-	-	-	2,0 <sup>(N-m)</sup>	-	-

### ■ Holders

● = Euro stock  
○ = Japan stock

<sup>(N-m)</sup> Recommended Tightening Torque (N·m)

## S Type Screw Lock Holders

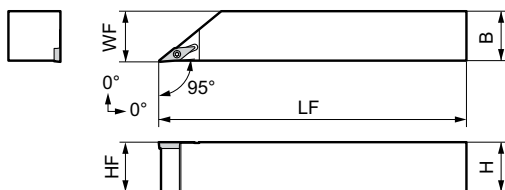
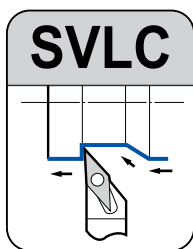

### ■ Inserts



### ■ Spare Parts

### ■ Holders

Above figures show right hand tools.

Cat. No.	Stock		Dimensions (mm)							Screw	Nm	Wrench	Insert
	R	L	H	HF	B	LF	WF						
SVLC R/L 1010 H11	●	●	10	10	10	100	10,5			BFTX02508NV	1,5	TRX08	1
SVLC R/L 1212 H11	●	●	12	12	12	100	12,5						
SVLC R/L 1616 H11	●	●	16	16	16	100	16,5						
SVLC R/L 2020 K11	○	○	20	20	20	125	20,5						
SVLC R/L 2525 M11	●	○	25	25	25	150	25,5						

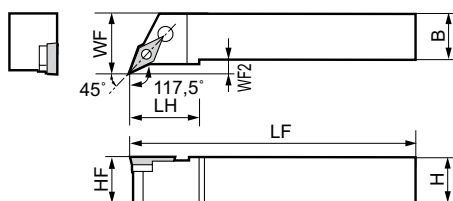
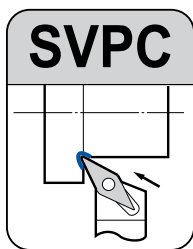

### ■ Inserts



### ■ Spare Parts

### ■ Holders

Above figures show right hand tools.

Cat. No.	Stock		Dimensions (mm)							Screw	Nm	Wrench	Insert
	R	L	H	HF	B	LF	LH	WF	WF2				
SVPC R/L 1010 H11	○	○	10	10	10	100	-	14,5	4,5	BFTX02508NV	1,5	TRX08	1
SVPC R/L 1212 H11	●	●	12	12	12	100	-	16,5	4,5				
SVPC R/L 1616 H11	●	●	16	16	16	100	-	20,5	4,5				

# External Tool Holders

## Polygon - Shank Holder



### ■ Features

The Sumitomo polygon shank holders enable an extremely high stiffness connection between machine and tool. The conical polygon can take high bending and torque moments based on the combination of the face contact to the spindle.

This self-guiding coupling system offers high precision and a repeatability of  $\pm 2 \mu\text{m}$  in X, Y and Z axis.

While using this easy and quick coupling system it is possible to gain higher machine utilization time as the set-up and tool change times are reduced.

The compact design and the high stiffness connection to the spindle offer a versatile use e.g. on multi-task machines, machining centers and turning-milling centers.



### ■ Characteristics

- original SUMITOMO D-type double clamping system
- compact design
- monoblock system - no additional interfaces
- precise positioning; self-guiding with high repeatability
- high stiffness supported by face contact of holder
- carbide shims to prevent holders from damage
- simple tool holder change and low-maintenance operation
- internal coolant supply directly to the cutting edge
- Polygon shank and insert seat hardened for long holder life

Polygon - shank holder - produced according to ISO 26623-1

Negative Insert Type



Positive Insert Type



### ■ Classification System for Polygon - Shank Holder

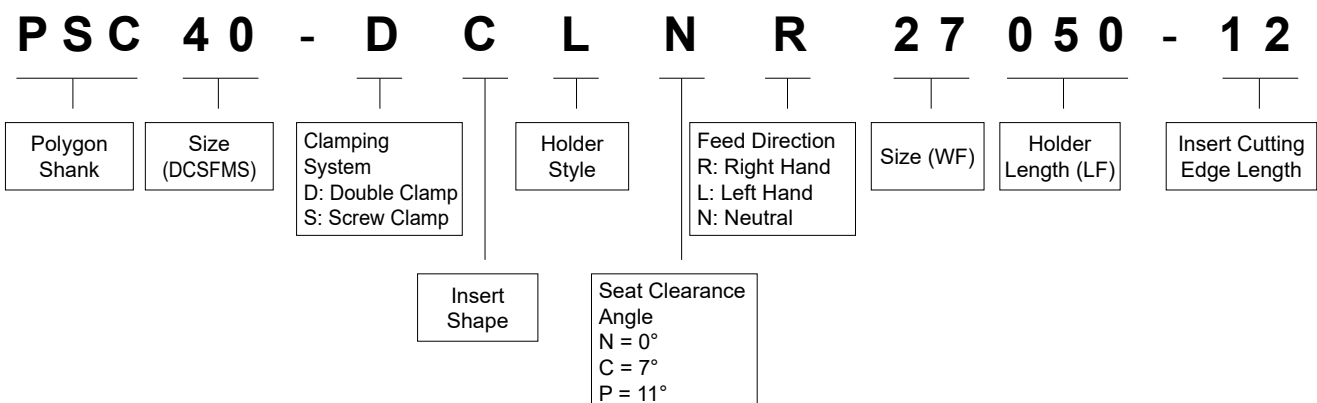

General Turning, Copying and Facing

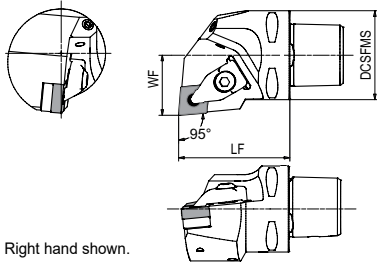
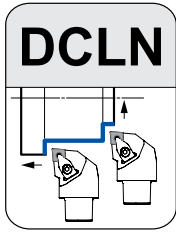

Right hand shown.

■ Holders

Cat. No.	Stock		Dimensions (mm)			Applicable Insert
	R	L	LF	WF	DCSFMS	
PSC40 DCLN R/L 27050-12	●	●	50	27	40	CN□□ 1204
PSC50 DCLN R/L 35060-12	●	●	60	35	50	

■ Inserts

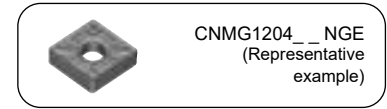

■ Spare Parts

Clamp Set	N-m		Shim	Shim Screw	Shim Wrench	Wrench
SCP-2	5,0		CNS1204	BFTX0409N	TRX15 (*)	LH040

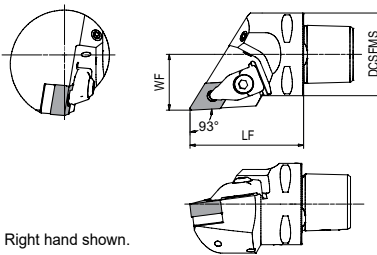
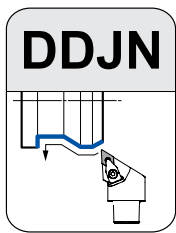

Right hand shown.

■ Holders

Cat. No.	Stock		Dimensions (mm)			Applicable Insert
	R	L	LF	WF	DCSFMS	
PSC40 DDJN R/L 27055-15	●	●	55	27	40	DN□□ 1506
PSC50 DDJN R/L 35060-15	●	●	60	35	50	

■ Inserts

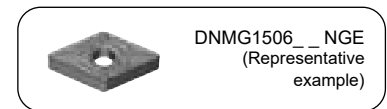

■ Spare Parts

Clamp Set	N-m		Shim	Shim Screw	Shim Wrench	Wrench
SCP-2	5,0		DNS1506	BFTX0409N	TRX15 (*)	LH040

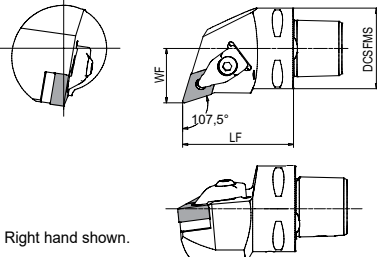
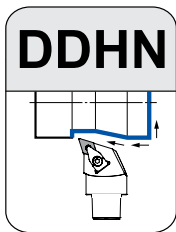

Right hand shown.

■ Holders

Cat. No.	Stock		Dimensions (mm)			Applicable Insert
	R	L	LF	WF	DCSFMS	
PSC40 DDHN R/L 27055-15	●	●	55	27	40	DN□□ 1506
PSC50 DDHN R/L 35060-15	●	●	60	35	50	

■ Inserts

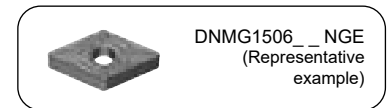

■ Spare Parts

Clamp Set	N-m		Shim	Shim Screw	Shim Wrench	Wrench
SCP-2	5,0		DNS1506	BFTX0409N	TRX15 (*)	LH040

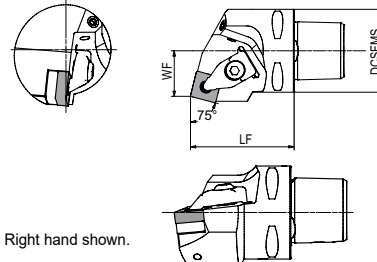
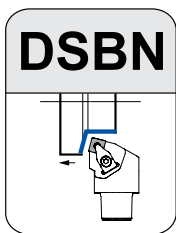

Right hand shown.

■ Holders

Cat. No.	Stock		Dimensions (mm)			Applicable Insert
	R	L	LF	WF	DCSFMS	
PSC40 DSBN R/L 22050-12		●	50	22	40	SN□□ 1204
PSC50 DSBN R/L 27060-12	●		60	27	50	

■ Inserts

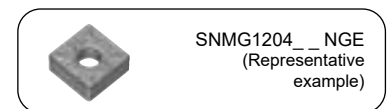

■ Spare Parts

Clamp Set	N-m		Shim	Shim Screw	Shim Wrench	Wrench
SCP-2	5,0		SNS1204	BFTX0409N	TRX15 (*)	LH040

(\*) Item is sold separately.

# External Tool Holders Polygon - Shank Holder

## Negative Insert Type

### General Turning and Facing

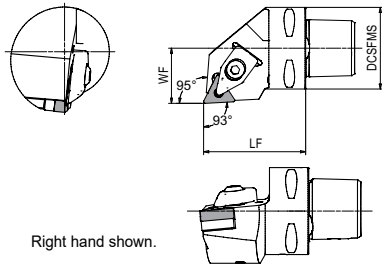
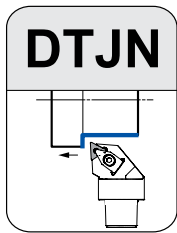

Right hand shown.

#### ■ Holders

Cat. No.	Stock		Dimensions (mm)			Applicable Insert
	R	L	LF	WF	DCSFMS	
PSC40 DTJN R/L 27050-16	●		50	27	40	TN□□ 1604
PSC50 DTJN R/L 35060-16	●		60	35	50	

#### ■ Inserts

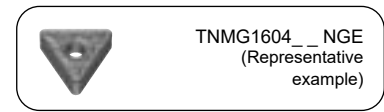

#### ■ Spare Parts

Clamp Set	$\text{N}\cdot\text{m}$	Shim	Shim Screw	Shim Wrench	Wrench
SCP-1	5,0	TNS1604	BFTX0307N	TRX15 (*)	LH040

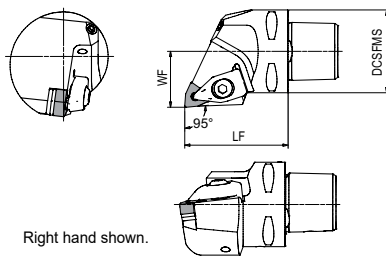
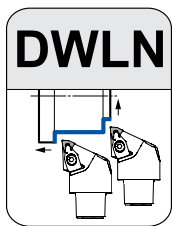

Right hand shown.

#### ■ Holders

Cat. No.	Stock		Dimensions (mm)			Applicable Insert
	R	L	LF	WF	DCSFMS	
PSC40 DWLN R/L 27050-06	●	●	50	27	40	WN□□ 06
PSC50 DWLN R/L 35060-06	●		60	35	50	
PSC40 DWLN R/L 27050-08	●	●	50	27	40	WN□□ 08
PSC50 DWLN R/L 35060-08	●		60	35	50	

#### ■ Inserts

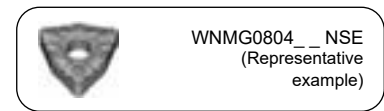

#### ■ Spare Parts

Clamp Set	$\text{N}\cdot\text{m}$	Shim	Shim Screw	Shim Wrench	Wrench
SCP-1	5,0	WNS0604	BFTX0307N	TRX15 (*)	LH040
SCP-2	5,0	WNS0804	BFTX0409N	TRX15 (*)	LH040

(\*) Item is sold separately.

External Holders  
for neg. Inserts

General Turning, Copying and Facing

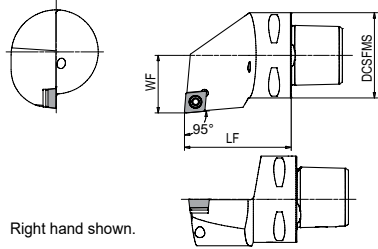
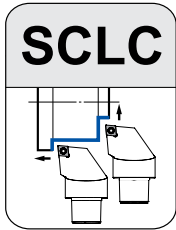

Right hand shown.

■ Holders

Cat. No.	Stock			Dimensions (mm)			Applicable Insert
	R	L	N	L <sub>1</sub>	f	DCSFMS	
PSC40 SCLC R/L 27050-09	●	●		50	27	40	CC□□ 09T3
PSC50 SCLC R/L 35060-09	●	●		60	35	50	

■ Inserts

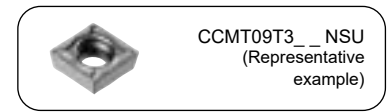

■ Spare Parts

Shim	Shim Screw	Insert Screw	(N·m)	Wrench	Shim Wrench
CCS09T3	KGBS1111	KSS1111	3,5	LT15K	LH035K*

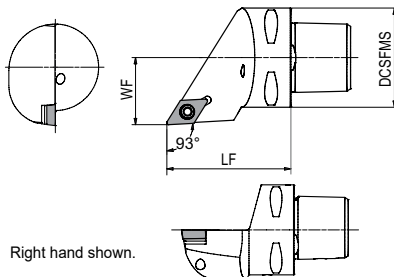
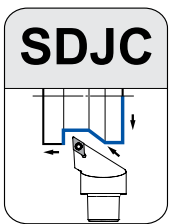

Right hand shown.

■ Holders

Cat. No.	Stock			Dimensions (mm)			Applicable Insert
	R	L	N	LF	WF	DCSFMS	
PSC40 SDJC R/L 27050-11	●	●		50	27	40	DC□□ 11T3
PSC50 SDJC R/L 35060-11	●	●		60	35	50	

■ Inserts

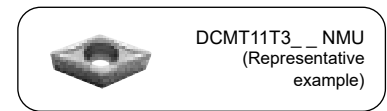

■ Spare Parts

Shim	Shim Screw	Insert Screw	(N·m)	Wrench	Shim Wrench
DCS11T3	KGBS1111	KSS1111	3,5	LT15K	LH035K*

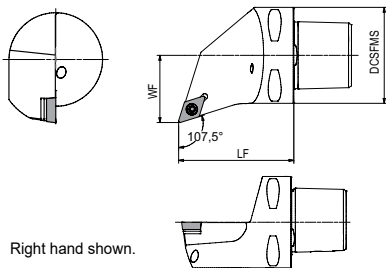

Right hand shown.

■ Holders

Cat. No.	Stock			Dimensions (mm)			Applicable Insert
	R	L	N	LF	WF	DCSFMS	
PSC40 SDHC R/L 27050-11	●	●		50	27	40	DC□□ 11T3
PSC50 SDHC R/L 35060-11	●	●		60	35	50	

■ Inserts

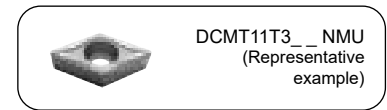

■ Spare Parts

Shim	Shim Screw	Insert Screw	(N·m)	Wrench	Shim Wrench
DCS11T3	KGBS1111	KSS1111	3,5	LT15K	LH035K*

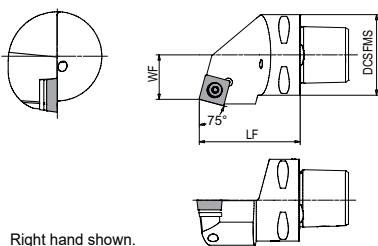
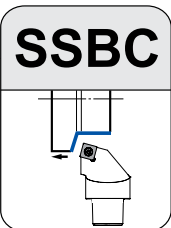

Right hand shown.

■ Holders

Cat. No.	Stock			Dimensions (mm)			Applicable Insert
	R	L	N	LF	WF	DCSFMS	
PSC40 SSBC R/L 22050-12				50	22	40	SC□□ 1204
PSC50 SSBC R/L 27060-12	●			60	27	50	

■ Inserts

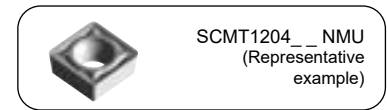

■ Spare Parts

Shim	Shim Screw	Insert Screw	(N·m)	Wrench	Shim Wrench
SCS1204	KGBS1221	KSS1221	4,5	LT15K	LH045K*

(\*) Item is sold separately.



# External Tool Holders Polygon - Shank Holder

## Positive Insert Type

### General Turning, Copying and Facing

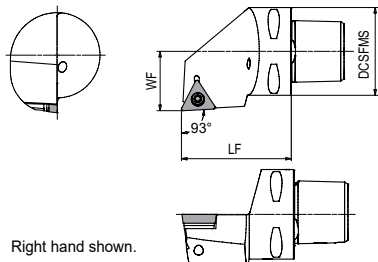
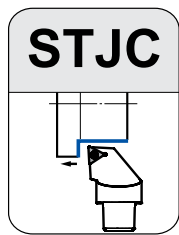

Right hand shown.

#### ■ Holders

Cat. No.	Stock			Dimensions (mm)			Applicable Insert
	R	L	N	LF	WF	DCSFMS	
PSC40 STJC R/L 27050-16	●			50	27	40	TC□□ 16T3
PSC50 STJC R/L 35060-16				60	35	50	

#### ■ Inserts

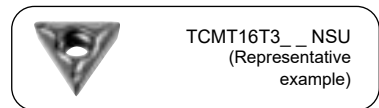

#### ■ Spare Parts

TCS16T3	KGBS1111	KSS1111	3,5	LH035K*

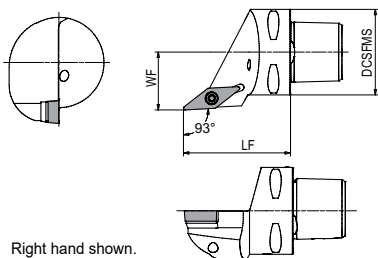
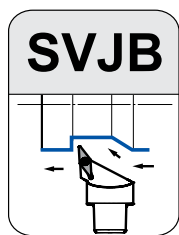

Right hand shown.

#### ■ Holders

Cat. No.	Stock			Dimensions (mm)			Applicable Insert
	R	L	N	LF	WF	DCSFMS	
PSC40 SVJB R/L 27050-16	●	●		50	27	40	VB□□ 1604
PSC50 SVJB R/L 35060-16		●		60	35	50	

#### ■ Inserts

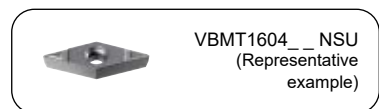

#### ■ Spare Parts

VCS1604	KGBS1111	KSS1111	3,5	LH035K*

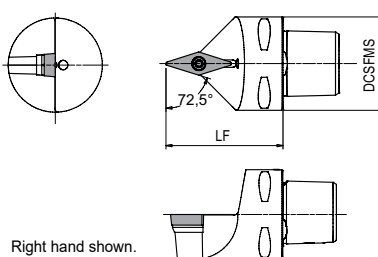
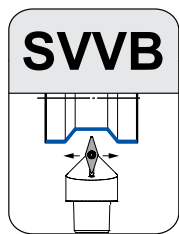

Right hand shown.

#### ■ Holders

Cat. No.	Stock			Dimensions (mm)			Applicable Insert
	R	L	N	LF	WF	DCSFMS	
PSC40 SVVB N 00050-16			●	50		40	VB□□ 1604
PSC50 SVVB N 00060-16				60		50	

#### ■ Inserts

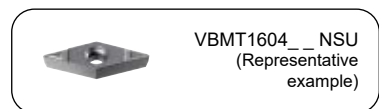

#### ■ Spare Parts

VCS1604	KGBS1111	KSS1111	3,5	LH035K*

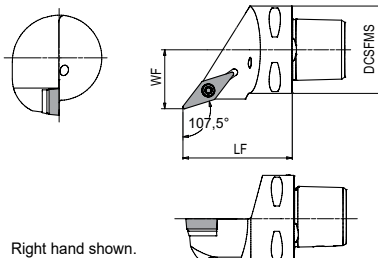
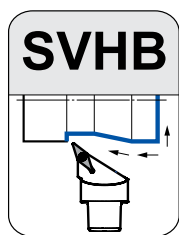

Right hand shown.

#### ■ Holders

Cat. No.	Stock			Dimensions (mm)			Applicable Insert
	R	L	N	LF	WF	DCSFMS	
PSC40 SVHB R/L 27050-16	●	●		50	27	40	VB□□ 1604
PSC50 SVHB R/L 35060-16	●			60	35	50	

#### ■ Inserts

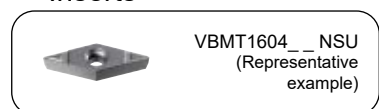

#### ■ Spare Parts

VCS1604	KGBS1111	KSS1111	3,5	LH035K*

(\*) Item is sold separately.

External Holders  
for pos. Inserts

## General Turning, Copying and Facing

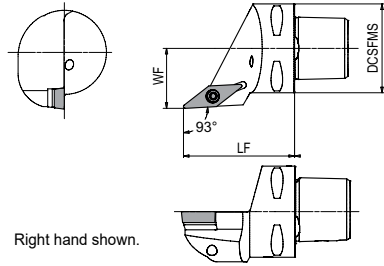
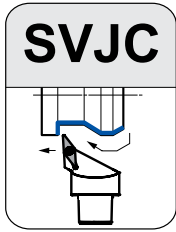

■ Holders

Cat. No.	Stock			Dimensions (mm)			Applicable Insert
	R	L	N	LF	WF	DCSFMS	
PSC40 SVJC R/L 27050-16	●			50	27	40	VC□□ 1604
PSC50 SVJC R/L 35060-16	●	●		60	35	50	

■ Inserts

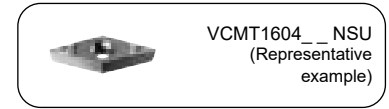

■ Spare Parts

Shim	Shim Screw	Insert Screw	$\text{N}\cdot\text{m}$	Wrench
VCS1604	KGBS1111	KSS1111	3,5	LT15K
				LH035K*

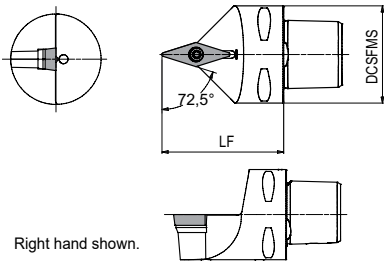
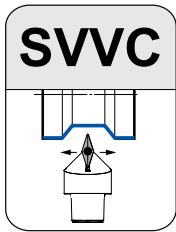

■ Holders

Cat. No.	Stock			Dimensions (mm)			Applicable Insert
	R	L	N	LF	WF	DCSFMS	
PSC40 SVVC N 00050-16				50		40	VC□□ 1604
PSC50 SVVC N 00060-16				60		50	

■ Inserts

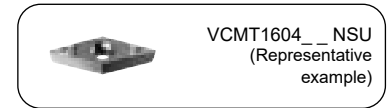

■ Spare Parts

Shim	Shim Screw	Insert Screw	$\text{N}\cdot\text{m}$	Wrench
VCS1604	KGBS1111	KSS1111	3,5	LT15K
				LH035K*

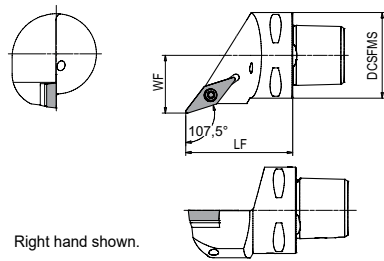

■ Holders

Cat. No.	Stock			Dimensions (mm)			Applicable Insert
	R	L	N	LF	WF	DCSFMS	
PSC40 SVHC R/L 27050-16	●	●		50	27	40	VC□□ 1604
PSC50 SVHC R/L 35060-16				60	35	50	

■ Inserts

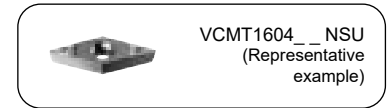

■ Spare Parts

Shim	Shim Screw	Insert Screw	$\text{N}\cdot\text{m}$	Wrench
VCS1604	KGBS1111	KSS1111	3,5	LT15K
				LH035K*

(\*) Item is sold separately.



# Boring Bars

E1-E24



Boring Bars

Selection	Boring Tool Selection Table .....	E2-4
ISO	Boring Tool Identification Table .....	E5
Features	Boring Tool Series .....	E6-7

## Boring Bars for Negative Insert Type :

CN_ _ :	<b>D...DCLN / S...PCLN</b> .....	E8
DN_ _ :	<b>D...DDUN / S...PDUN</b> .....	E9
SN_ _ :	<b>S...PSKN</b> .....	E10
<b>SumiTurn T-Rex</b>	<b>S...DTR</b> .....	E11
TN_ _ :	<b>D...DTFN / S...PTFN</b> .....	E12
WN_ _ :	<b>D...DWLN / S...WMLN</b> .....	E13

## Boring Bars for Positive Insert Type :

<b>X-Bar</b> for CC_ _ :	<b>B/D...SCLC</b> .....	E14
CC_ _ :	<b>S ... SCLC</b> .....	E14
CP_ _ :	<b>S/C...SCLP</b> .....	E15
<b>X-Bar</b> for DC_ _ :	<b>B/D...SDUC / SDQC</b> .....	E16-17
DC_ _ :	<b>S ... SDQC / SDUC</b> .....	E16-17
SP_ _ :	<b>S/C...SSKP</b> .....	E18
TC_ _ :	<b>S ... STFC</b> .....	E19
<b>X-Bar</b> for TP_ _ :	<b>B/D...STUP</b> .....	E20
TP_ _ :	<b>S/C...STUP</b> .....	E20
<b>X-Bar</b> for VB_ _ :	<b>D ... SVUB / SVZB</b> .....	E21
VB_ _ :	<b>S ... SVQB / SVUB / SVZB</b> .....	E22
WB_ _ :	<b>S/C...SWUB</b> .....	E23

Very Small Dia. Boring	<b>BXBR...R(-NB)</b> .....	E24
------------------------	----------------------------	-----

# Boring Tools Selection

According to Applications / Bore Diameter

## BORING TOOLS

Coloured boxes indicate available size.

Application	Type	Boring Depth (L/D)			Applicable Insert	Tooling	Min. Bore Diameter (mm)																							
		Shank					(Min. cutting diameter is shown when not matched in this table.)																							
		Steel	Carbide	X-Bar (Steel)			2	2.5	3	3.5	4	4.5	5	6	7	8	10	12	13	14	16	18	20	22	25	28	35	44	54	70
Very Small Dia. Boring	BXBR ⇒ E24			-5	Special boring bar		○	○	○	○	○	○																		
	DABB ⇒ M57			-2	Sumidia brazed				●	●	●	●	●																	
Stop Boring	BSME ⇒ M48-M50			-4	Sumiboron brazed		●	●	●	●	●																			
	SEXC ⇒ M48,49,51			-3	Sumiboron insert					●	●	●																		
	BNBB ⇒ M52			-5	Sumiboron brazed				●	●	●	●	●																	
	BNB ⇒ M53			-4	Sumiboron insert									●	●	●	●	●												
	S/C-SWUB ⇒ E23			-3	-8	Trigon Type 5° Pos.							●																	
	S-STFC ⇒ E19			-3													●	●	●	●	●			●	●	●	●			
	B/D-STUP ⇒ E20			-6													●	●	●	●	●	●	●	●	●	●	●			
	S-STUP(B) ⇒ E20			-3		Triangle Type 5° & 11° Pos.											●	●	●	●	●	●	●	●	●	●	●			
	C-STUP ⇒ E20			-8													●	●	●	●	●	●	●	●	●	●	●			
	CTFP ⇒ Stock in Japan			-3		Triangle 11° Pos.														○	○	○	○	○	○	○	○			
	D-DTFN ⇒ E12			-3	-6																					●	●	●		
	S-PTFN ⇒ E12					Triangle Neg. Type																				●	●	●		
	Bottom Facing	BNZ ⇒ M53			-5	Sumiboron insert												●	●	●	●	●	●							
		S-SCLP ⇒ E15			-3																									
B-SCLP ⇒ Stock in Japan				-6		80° Diamond 11° Pos. Type														○	○	○	○	○	○	○	○			
C-SCLP ⇒ E15				-8																										
B/D-SCLC ⇒ E14				-6																						●	●			
S-SCLC ⇒ E14				-3		80° Diamond 7° Pos. Type																					●	●	●	
C-SCLC ⇒ Stock in Japan				-8																										
D-DCLN ⇒ E8				-6																							●	●	●	
S-PCLN ⇒ E8				-3		80° Diamond Neg. Type																						●	●	●
D-DWLN ⇒ E13				-6																								●	●	●
S-MWLN ⇒ E13			-3		Trigon Neg. Type																						●	●	●	

Boring Bars





# Boring Tool Series

## TOOLING SELECTION

Application		Stop Boring		Bottom Facing		Trough Boring	Copying		
Insert Type System	Triangle	Poligon / Others	80° Diamond		Square	55° T-REX	55° Diamond	35° Diamond	
	Screw Lock	Steel	 <b>S-STFC</b> ⇨ E19 <b>S-STUP(B)</b> ⇨ E20	 <b>S-SWUB</b> ⇨ E23	 <b>S-SCLC</b> ⇨ E14	 <b>S-SCLP</b> ⇨ E15	 <b>S-SSKP</b> ⇨ E18	—	 <b>S-SDUC</b> ⇨ E16 <b>S-SDQC</b> ⇨ E17
Anti-vibration		 <b>B-STUP</b> ⇨ E20	—	 <b>B-SCLC</b> ⇨ E14	—	—	—	 <b>B-SDUC</b> ⇨ E16 <b>B-SDQC</b> ⇨ E17	—
Anti-vibration with Oil Hole		 <b>D-STUP</b> ⇨ E20	—	 <b>D-SCLC</b> ⇨ E14	—	—	—	 <b>D-SDUC</b> ⇨ E16 <b>D-SDQC</b> ⇨ E17	 <b>D-SVUB</b> ⇨ E21 <b>D-SVZB</b> ⇨ E21
Carbide		 <b>C-STUP</b> ⇨ E20 ( <b>C-STUB</b> ) ⇨ E20	 <b>C-SWUB</b> ⇨ E23	—	 <b>C-SCLP</b> ⇨ E15	 <b>C-SSKP</b> ⇨ E18	—	—	—
Lever Lock	Steel	 <b>S-PTFN</b> ⇨ E12	—	 <b>S-PCLN</b> ⇨ E8	—	 <b>S-PSKN</b> ⇨ E10	—	 <b>S-PDUN</b> ⇨ E9	—
	Anti-vibration with Oil Hole	 <b>D-DTFN</b> ⇨ E12	 <b>D-DWLN</b> ⇨ E13	 <b>D-DCLN</b> ⇨ E8	—	—	—	 <b>D-DDUN</b> ⇨ E9	—
Top Clamp	Steel	—	 <b>S-MWLN</b> ⇨ E13	—	—	—	 <b>S-DTR</b> ⇨ E11	—	—
	Carbide	 <b>BNB</b> ⇨ M53	 <b>BNBB</b> ⇨ M52	 <b>BNZ</b> ⇨ M53	—	 <b>BXBR</b> ⇨ E24			
CBN	Carbide	 <b>BSME</b> ⇨ M48	 <b>SEXC</b> ⇨ M51	—	—	—	—	—	

Boring Bars

# Boring Tools Identification

## ■ Catalogue Classification System For Boring Holders

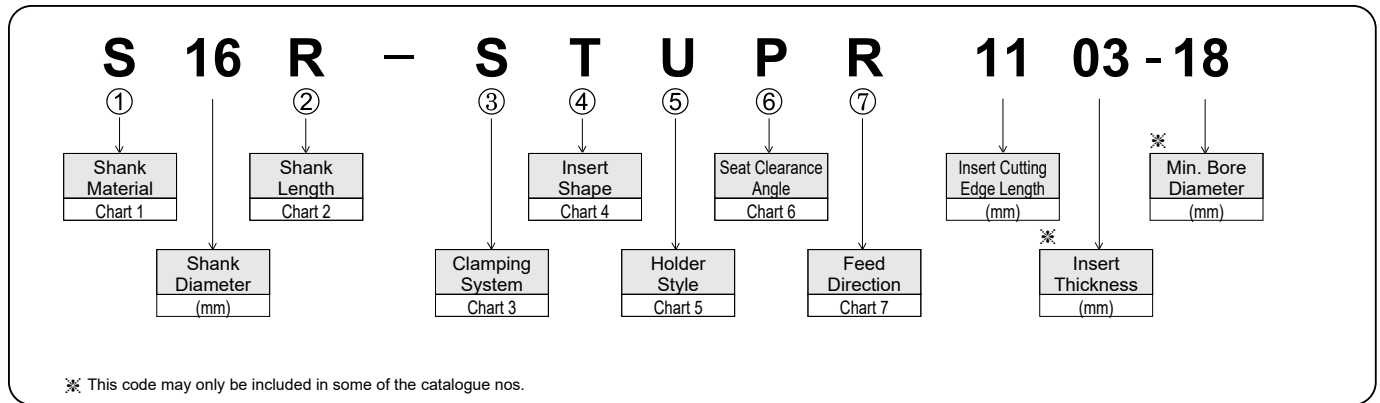

① Chart 1

Shank Material	
S	Steel
B	Steel with Anti-vibration Mechanism without Oil Hole
C	Carbide
D	Steel with Anti-vibration Mechanism with Oil Hole
E	Carbide with Oil Hole

② Chart 2

Shank Length			
Symbol	Length (mm)	Symbol	Length (mm)
F	80	P	170
G	90	Q	180
H	100	R	200
J	110	S	250
K	125	T	300
L	140	U	350
M	150	V	400
N	160	W	450

③ Chart 3

Clamping System					
Symbol	System	Structure	Symbol	System	Structure
C	Top Clamp		M	Top & Hole Clamp Type	
D	Double Clamp		P	Lever Lock Type (Insert is Supported by 1 face)	
E	Pin Lock Type (Insert is supported by 1 face)		S	Screw Clamp Type	

⑦ Chart 7

Feed Direction	
Symbol	Feed Direction
R	Right Hand Feed
L	Left Hand Feed
N	Neutral Feed

④ Chart 4

Insert Shape			
Symbol	Insert Shape	Symbol	Insert Shape
A	Parallelogram 85°	M	Rhombic 86°
B	Parallelogram 82°	O	Octagonal
C	Diamond 80°	P	Pentagonal
D	Diamond 55°	R	Round
E	Diamond 75°	S	Square
F	Diamond 50°	T	Triangular
H	Hexagonal	V	Diamond 35°
K	Parallelogram 55°	W	Trigon
L	Rectangular		

⑤ Chart 5

Holder Style					
Symbol	Shape	Offset	Symbol	Shape	Offset
A		Nil	N		Nil
B		Nil	Q		With Offset
D		Nil	R		With Offset
E		Nil	S		With Offset
F		With Offset	T		With Offset
G		With Offset	U		With Offset
J		With Offset	W		With Offset
K		With Offset	Y		With Offset
L		With Offset	Z		With Offset

⑥ Chart 6

Seat Clearance Angle	
Symbol	Relief Angle
A	3°
B	5°
C	7°
D	15°
E	20°
F	25°
G	30°
N	0°
P	11°
O	Special Angle

# Boring Bars

## Boring Tool Series



### General Features

Since being the first in 1976 to introduce indexable boring bars, Sumitomo Electric has been continuously developing a comprehensive range which includes the SEC-Small Hole boring bar series, high rigidity boring head series, with either steel / carbide shanks, and the latest anti-vibration mechanism - SumiTurn X-Bar series coupled with a wide variety of insert grades and chipbreakers, cover a whole range of process requirements.

### Features

- Wide selection for various boring operations
- Minimum bore diameter from  $\varnothing$  5,5 mm onwards
- New anti-vibration boring bars, SumiTurn X-Bar.
- High rigidity head-design for small boring bars
- Wide selection of grades and chipbreakers available for various processes and work materials

### Series SumiTurn X Bar

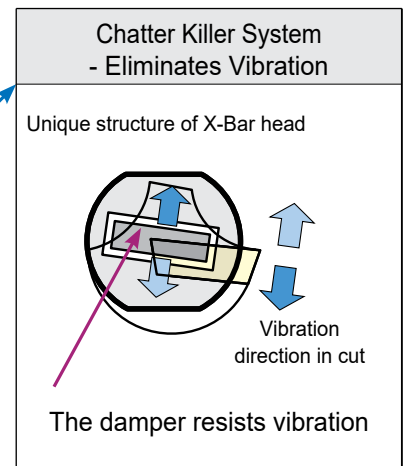
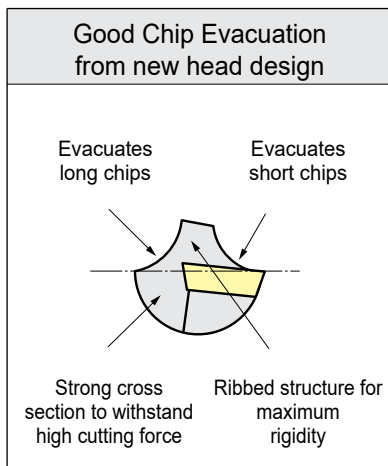

- New negative type "X Bar" with high performance double clamping system

### Application Guide

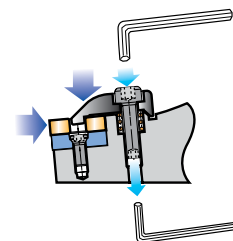
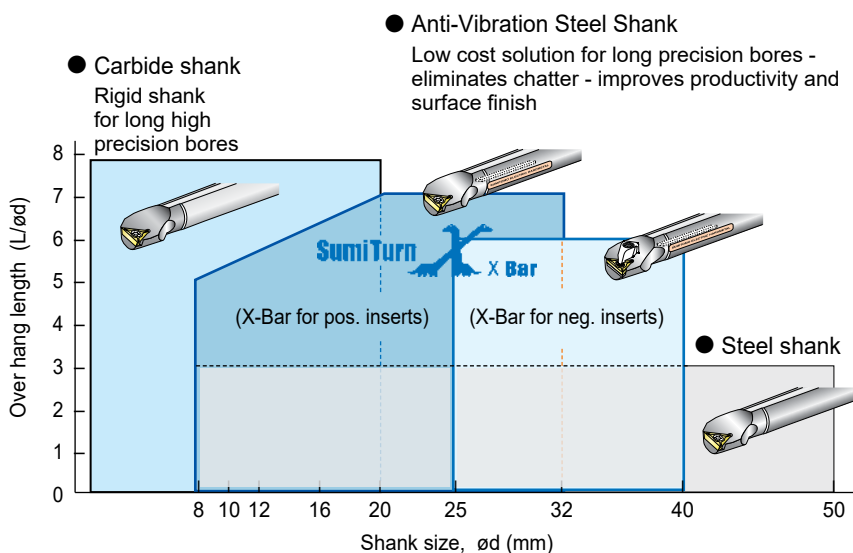

**SumiTurn X Bar**

**ATTENTION:**



Please keep this area free to get the effect of "X Bar" chattering killer system

Min. over hang length =  $3,5 \times \varnothing d$

# Boring Bars

## Boring Tool Series

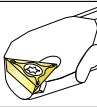
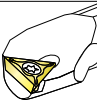
### Recommended Over Hang Length / Shank Diameter (L/D)

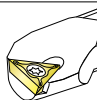
Type of boring bar		Over hang length (L/D)										
		1	2	3	4	5	6	7	8	9	10	
<ul style="list-style-type: none"> <li>● Steel Shank</li> </ul> Rigid head design for low cost hole boring.		[Shaded area from 1 to 3]										
<ul style="list-style-type: none"> <li>● Anti-Vibration Type Shank</li> </ul> Chatter killer system eliminates vibration - improves productivity - improves quality		(X-Bar for pos. inserts) (X-Bar for neg. inserts) 										
<ul style="list-style-type: none"> <li>● Carbide Shank</li> </ul> High rigidity shank for high accuracy hole boring.		[Shaded area from 1 to 10]										

### Grades

Tool Material	Process	Work Material									
		High Precision	Finish-Light Cut	Medium Cut	P General Steel	M Stainless Steel	K Cast Iron	S Heat Resistant Alloy	H Hardened Steel	N Non-Ferrous Metal	Sintered Alloy
Coated Carbide	CVD		AC8015P								
			New AC8020P								
			AC8025P								
			AC8035P								
			AC6020M								
			AC6030M								
			AC4010K								
			AC4015K								
		AC420K									
	PVD		ACZ150								
			AC5015S								
			AC5025S								
			AC530U								
			AC1030U								
	AC6040M										
Cermet Coated Cermets		T1000A									
		T1500A/T1500Z									
		T2500Z									
Carbide		G10E									
SumiBoron		BN1000									
		BN2000									
		BNC2010									
		New BNC2115									
		BNC2020									
		New BNC2125									
		BN7000									
SumiDia		BN7115									
		DA1000									
		DA150									

⊙ Preferred choice    ○ Suitable

### Recommended Chip Breakers

● M-Class Finish-Light-Cut

● M-Class Light-Medium-Cut

● G-Class Ground Typ

● G-Class Breaker

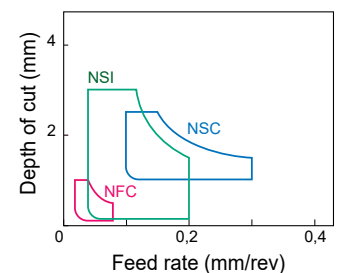
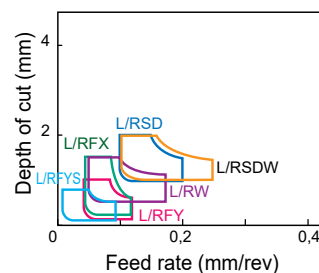
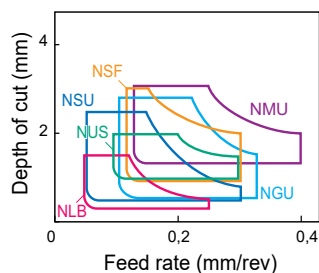
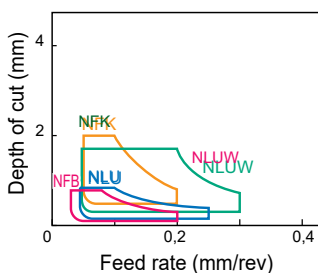

# D...DCLN / S...PCLN Type



SumiTurr X Bar

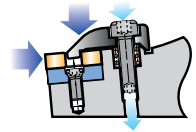

Insert (eg.)



N-GU

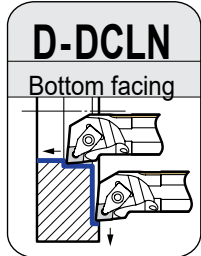

Anti-vibration D type with oil hole

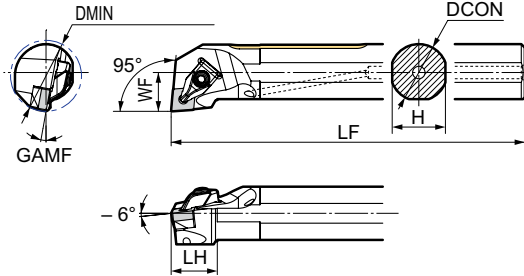

### Spare Parts

Clamp	Spring	Clamp bolt	Shim	Shim screw	Wrench	Wrench
SCP-2			CNS1203B	BFTX0307N	TRX10 <sup>(*)</sup>	LH040
			CNS1204B	BFTX0409N ③ 3.4	TRX15 <sup>(*)</sup>	LH025

### ■ Holders

Above figures show right hand tools.

Cat. No.	Stock		$\phi D_{min}$	Dimensions (mm)							Insert (eg.)
	R	L		$\phi d$	h	$l_1$	$l_2$	f	$\gamma$		
D25T - DCLN R/L 1204-32	●	●	32	25	23	300	26	17	-12°	CN□□1204□□	
D32T - DCLN R/L 1204-40	●	●	40	32	30	300	26	22	-10°		
D40U - DCLN R/L 1204-50	●	●	50	40	37	350	26	27	-10°		

(\*) Note: Wrench (TRX type) for shim screw is not included.

Remarks: Right handed tool holders are applicable with left handed or neutral inserts.  
Left handed tool holders are applicable with right handed or neutral inserts.

### ■ Holders

Tool holders (P type) with lever-lock system	Cat. No.	Stock		Dimensions (mm)							Image
		R	L	$\phi D_{min}$	d	h	$l_1$	$l_2$	f	$\gamma$	
	S20S - PCLN R/L09	●	●	25	20	18	250	29	13	-11°	CN__0903__
	S25T - PCLN R/L09	●		30	25	23	300	33	17	-10°	
	S25T - PCLN R/L12	●	●	32	25	23	300	42	17	-10°	CN__1204__
	S32U - PCLN R/L12	●	●	40	32	30	350	49	22	-11°	
	S40V - PCLN R/L12	●	●	50	40	37	400	56	27	-10°	
	S32U - PCLN R/L16			40	32	30	350	56	22	-11°	CN__1606__
	S40V - PCLN R/L16	●	●	50	40	37	400	56	27	-10°	
	S50W - PCLN R/L16			63	50	47	450	56	35	-11°	
	S50W - PCLN R/L19			63	50	47	450	63	35	-11°	CN__1906__

All figures show right hand tools.

### ■ Applicable Inserts

### ■ Spare Parts

Holder	Carbides, Cermets		CBN, PCD	Lever pin	Clamp bolt	Shim	Shim pin	Wrench
	Double sided	One sided						
S - PCLN R/L								
S.....09	CNMG 0903__ NGU	-	-	LCL3C-SD	LCS3B-SD	-	-	LH020
S25T.....12	CNMG 1204__ NGU	CNMM 1204__ NMP	CNGA 1204__	LCL4C-SD	LCS4B-SD	-	-	LH025
S32U.....12	CNMG 1204__ NGU	CNMM 1204__ NMP	CNGA 1204__	LCL4T-SD	LCS41BS-SD	LSC42SD	LSP4SD	LH030
S40V.....12	CNMG 1204__ NGU	CNMM 1204__ NMP	CNGA 1204__	LCL4SD	LCS42BS-SD	LSC42SD	LSP4SD	LH030
S.....16	CNMG 1606__ NGU	CNMM 1606__ NMP	-	LCL5SD	LCS5B-SD	LSC53SD	LSP5SD	LH030
S.....19	CNMG 1906__ NGU	CNMM 1906__ NMP	-	LCL5C-SD	LCS6B-SD	LSC63SD	LSP6SD	LH040

● = Euro stock  
○ = Japan stock

Recommended Tightening Torque (N·m)

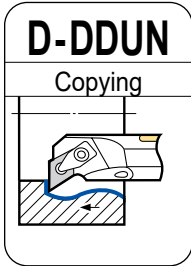

Anti-vibration D type with oil hole

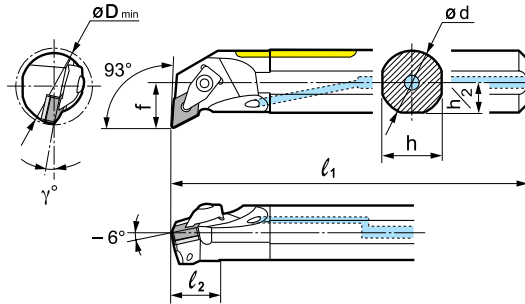

SumiTurn X Bar

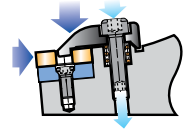

Insert (eg.)



N-GU

### ■ Holders

Above figures show right hand tools.

Cat. No..	Stock		$\phi D_{min}$	Dimensions (mm)							Insert (eg.)	Clamp	Spring	Clamp bolt	Shim	Shim Screw	Wrench	Wrench
	R	L		$\phi d$	h	$l_1$	$l_2$	f	$\gamma$									
D32T - DDUN R/L 1104-40	●	○	40	32	30	300	26	22	-10°	DN□□1104□□		SCP-1		DNS1104B	BFTX0307N	TRX10(*)		
D32T - DDUN R/L 1506-40	●	●	40	32	30	300	26	22	-12°								LH040	LH025
D40U - DDUN R/L 1506-50	●	●	50	40	37	350	26	27	-12°	DN□□1506□□		SCP-2		DNS1506B	BFTX0409N ③ 3.4	TRX15(*)		

(\*) Note: Wrench (TRX type) for shim screw is not included.

Remarks: Right handed tool holders are applicable with left handed or neutral inserts.  
Left handed tool holders are applicable with right handed or neutral inserts.

### ■ Holders

Tool holders (P type) with lever-lock system	Cat. No.	Stock		Dimensions (mm)							Image	
		R	L	$\phi D_{min}$	d	h	$l_1$	$l_2$	f	$\gamma$		
<p>S - PDUN R/L</p>	S25T - PDUN R/L 11	●	●	32	25	23	300	35	17	-11°	DN__ 1104__	
	S32U - PDUN R/L 15 04	●	●	40	32	30	350	40	22	-11°	DN__ 1504__	
	S40V - PDUN R/L 15	●	●	50	40	37	400	56	27	-11°	DN__ 1506__	
	S50W - PDUN R/L 15			63	50	47	450	63	35	-10°		

All figures show right hand tools.

### ■ Applicable Inserts

### ■ Spare Parts

Holder	Carbides, Cermets		CBN, PCD	Lever pin	Clamp bolt	Shim	Shim pin	Wrench	
	Double sided	One sided							
S - PDUN R/L									
S25T ....11	DNMG 1104__ NGU	-	DNGA 1104__	LCL3DB-SD	LCS3DB-SD	-	-	LH020	
S32U ....15 04	DNMG 1504__ NGU	DNMM 1504__ NMP	DNGA 1504__	LCL4D-SD	LCS5DB-SD	LSD42SD	LSP4SD	LH030	
S40V ....15	DNMG 1506__ NGU	DNMM 1506__ NMP	DNGA 1506__	LCL4D-SD	LCS5DB-SD	LSD42SD	LSP4SD	LH030	
S50W....15	DNMG 1506__ NGU	DNMM 1506__ NMP	DNGA 1506__	LCL4D-SD	LCS5DB-SD	LSD42SD	LSP4SD	LH030	



# Boring Bars S...PSKN Type

For Negative SN \_\_ - Inserts ( $\alpha = 0^\circ$ )



## ■ Holders

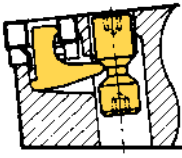
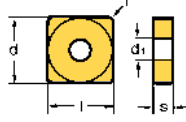
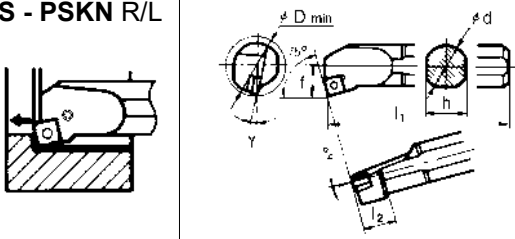







 Tool holders (P type) with lever-lock system	Cat. No.	Stock		Dimensions (mm)							
		R	L	$\phi D_{min}$	d	h	$l_1$	$l_2$	f	$\gamma$	
<b>S - PSKN R/L</b> 	S25T - PSKN R/L 12	●		32	25	23	300	42	17	-11°	SN __ 1204 __
	S32U - PSKN R/L 12	●		40	32	30	350	45	22	-10°	
	S40V - PSKN R/L 12	●	●	50	40	37	400	50	27	-10°	
	S40V - PSKN R/L 15	●		63	40	47	400	60	35	-10°	SN __ 1506 __
	S50W - PSKN R/L 15			63	50	47	450	60	35	-10°	
	S50W - PSKN R/L 19			63	50	47	450	60	35	-9°	SN __ 1906 __

All figures show right hand tools.

Boring Bars  
for neg. insert

## ■ Applicable Inserts

## ■ Spare Parts

Holder	Carbides, Cermets		CBN	Lever pin	Clamp bolt	Shim	Shim pin	Wrench	
	Double sided	One sided							
S - PSKN R/L									
S25T....12	SNMG 0903 __ NGU	-	-	LCL4C-SD	LCS4B-SD	-	-	LH025	
S32U....12	SNMG 1204 __ NGU	SNMM 1204 __ NMP	SNGA 1204 __	LCL4T-SD	LCS41BS-SD	LSS42SD	LSP4SD	LH030	
S40V....12	SNMG 1204 __ NGU	SNMM 1204 __ NMP	SNGA 1204 __	LCL4SD	LCS42BS-SD	LSS42SD	LSP4SD	LH030	
S....15	SNMG 1506 __ NGU	SNMM 1506 __ NMP	-	LCL5SD	LCS5B-SD	LSS53SD	LSP5SD	LH030	
S....19	SNMG 1906 __ NGU	SNMM 1906 __ NMP	-	LCL5C-SD	LCS6B-SD	LSS63SD	LSP6SD	LH040	

## Internal Turning & Copying

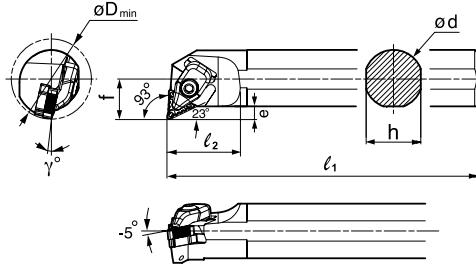
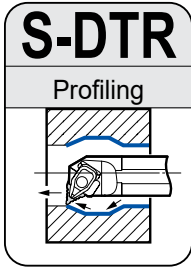
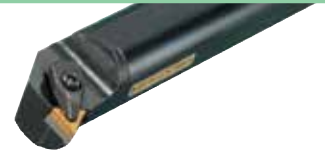

### Spare Parts

Clamp	Spring	Screw	Shim	Screw	Wrench	Wrench
TRCP3	S-SP4-20	BX0520	TRW5505	BFTX0307N 2.0	TSW040	TRX10 <sup>(*)</sup>

### ■ Holders

Above figures show right hand tools.

Cat. No.	Stock		Dimensions (mm)							
	R	L	$\phi D_{min}$	$\phi d$	h	$l_1$	$l_2$	f	$\gamma$	e
S32S-DTR55C R/L-17	●		44	32	30	250	40	22	-12°	7
S40T-DTR55C R/L-17	●	○	50	40	37	300	40	25	-10°	6,2

(\*) Note: Wrench (TRX10) for shim is not included.

### ■ Advantages

#### ● T-REX Inserts for Maximum Economy

With 6 cutting edges and a 55 degree included angle - T-Rex is the intelligent alternative to profile turning with a traditional 4 edge DNMG insert.

### ■ Inserts

Applic.	Shape	Cat. No.	r	Coated Carbide			Coated Cermet
				AC8015P	AC8025P	AC630M	T3000Z
Fine Finishing		TRM 551704-FL	0,4		○		○
		551708-FL	0,8		○		○
Finishing		TRM 551704-LU	0,4	●	○		○
		551708-LU	0,8	●	○		○
		551712-LU	1,2		○		○
		TRM 551704-SU	0,4		○	●	○
		551708-SU	0,8		○	●	○
551712-SU	1,2		○				
Light Cut		TRM 551704-GU	0,4		○	●	
		551708-GU	0,8		○	●	
		551712-GU	1,2		○		

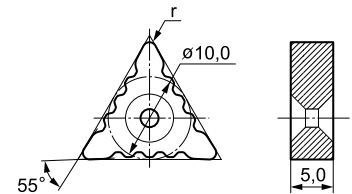

Application **P** Steel  
**M** Stainless steel



SumiTurn X Bar

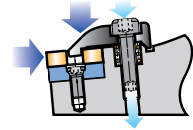

Insert (eg.)



N-GU

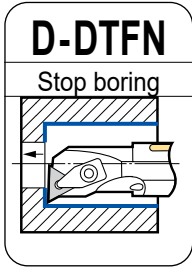

**D-DTFN**

Stop boring

Anti-vibration D type with oil hole

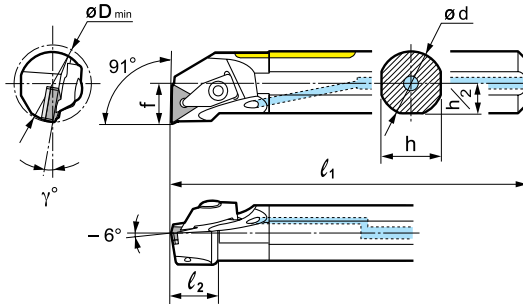

### Spare Parts

Clamp	Spring	Clamp bolt	Shim	Shim Screw	Wrench	Wrench
SCP-1			TNS1603B TNS1604B	BFTX0307N 2.0	TRX10 <sup>(*)</sup>	LH040 LH025

### ■ Holders

Above figures show right hand tools.

Cat. No.	Stock		Dimensions (mm)							Insert (eg.)
	R	L	$\phi D_{min}$	$\phi d$	h	$l_1$	$l_2$	f	$\gamma$	
D25T - DTFN R/L 1604-32	●	●	32	25	23	300	21	17	-12°	TN□□1604□□
D32T - DTFN R/L 1604-40	●	●	40	32	30	300	26	22	-10°	
D40U - DTFN R/L 1604-50	●	●	50	40	37	350	26	27	-10°	

(\*) Note: Wrench (TRX type) for shim screw is not included.

### ■ Holders

Tool holders (P type) with lever-lock system	Cat. No.	Stock		Dimensions (mm)							Image
		R	L	$\phi D_{min}$	d	h	$l_1$	$l_2$	f	$\gamma$	
<p><b>S - PTFN R/L</b></p>	S20S - PTFN R/L 11			25	20	18	250	30	13	-12°	TN__1103__
	S25T - PTFN R/L 16	●	●	32	25	23	300	43,3	17	-13°	TN__1604__
	S32U - PTFN R/L 16	●	●	40	32	30	350	49,6	27	-12°	
	S40V - PTFN R/L 16	●		50	40	37	400	49,5	27	-11°	
	S50W - PTFN R/L 16			63	50	47	450	56	35	-10°	TN__2204__
	S40V - PTFN R/L 22	●		50	40	37	400	59	27	-11°	
	S50W - PTFN R/L 22			63	50	47	450	66	35	-10°	

All figures show right hand tools.

### ■ Applicable Inserts

### ■ Spare Parts

Holder	Carbides, Cermets		CBN	Lever pin	Clamp bolt	Shim	Shim pin	Wrench
	Double sided	One sided						
S - PTFN R/L								
S...11	-	-	-	LCL3T-SD	LCS3B-SD	-	-	LH020
S...16	TNMG 1604__ NGU	TNMM 1604__ NMP	TNGA 1604__	LCL3SD	LCS3TB-SD	LST317SD	LSP3SD	LH025
S...22	TNMG 2204__ NGU	TNMM 2204__ NMP	TNGA 2204__	LCL4SD	LCS42BS-SD	LST42SD	LSP4SD	LH030

Boring Bars for neg. insert



# Boring Bars B/D/S...SCLC Type

For Positive CC\_\_ - Inserts ( $\alpha = 7^\circ$ )

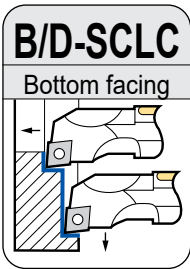

**B Type** (Fig.1)  
Min. Bore Dia.

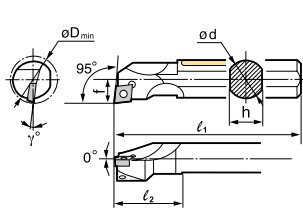

**D Type** (Fig.2)

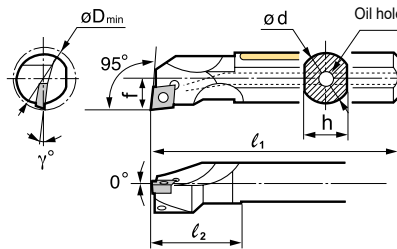

Insert (ex.)



### Spare Parts



### ■ Holders

Steel shank	Cat. No.	Stock		$\phi D_{min}$	Dimensions (mm)						Fig.	Insert (ex.)	Screw	Wrench	
		R	L		$\phi d$	h	$l_1$	f	$l_2$	$\gamma$					
Anti-vibration B type	B08H - SCLC R/L 0602-10	●	●	10	8	7	100	5,5	19	-13°	1.	CC□T 0602□□	BFTX02505N	TRX08	
	B10K - SCLC R/L 0602-12	●	●	12	10	9	125	6	21	-12°			BFTX02506N		
Anti-vibration D type with oil hole	D12M - SCLC R/L 0602-14	●	●	14	12	11	150	7	25	-10°	2.	CC□T 09T3□□	BFTX0407N	TRX15	
	D16R - SCLC R/L 09T3-18	●	●	18	16	15	200	11	30	-8°			BFTX0409N		
	D20S - SCLC R/L 09T3-22	●	●	22	20	18	250	13	30	-7°			BFTX0511N		
	D25T - SCLC R/L 1204-32	●	●	32	25	23	300	17	38	-6°			◎ 5.0		TRX20
	D32T - SCLC R/L 1204-40	●	●	40	32	30	300	20	53	-6°			◎ 5.0		

All figures show right hand tools.

Remarks: Right handed tool holders are applicable with left handed or neutral inserts.  
Left handed tool holders are applicable with right handed or neutral inserts.

### ■ Holders

Tool holders (S type) with screw-lock system	Cat. No.	Stock		Dimensions (mm)							
		R	L	$\phi D_{min}$	d	h	$l_1$	$l_2$	f	$\gamma$	
<b>S - SCLC R/L</b> 	S10K - SCLC R/L 06			13	10	9	125	9	7	-12°	CC__ 0602__
	S12M - SCLC R/L 06			16	12	11	150	11	9	-10°	
	S16R - SCLC R/L 06	●	●	20	16	15	200	15	11	-8°	
	S16R - SCLC R/L 09			20	16	15	200	15	11	-8°	CC__ 09T3__
	S20S - SCLC R/L 09			25	20	18	250	20	13	-7°	
	S25T - SCLC R/L 12			32	25	23	300	20	17	-6°	CC__ 1204__
	S32U - SCLC R/L 12	●	●	40	32	30	350	25	22	-10°	
	S40V - SCLC R/L 12	●	●	50	40	37	400	25	27	-8°	

All figures show right hand tools.

### ■ Applicable Inserts

### ■ Spare Parts

Holder	Carbides, Cermets		Screw	$\overset{N\cdot m}{\curvearrowright}$	Wrench			
S - SCLC R/L				$\overset{N\cdot m}{\curvearrowright}$				
S.....06	CCMT 0602__ NFP	CCGW 0602__	-	BFTX02505N	1,1	TRX08		
S16R.....09	CCMT 09T3__ NFP	CCGW 09T3__	-	BFTX0407N	3,0	TRX15		
S20S.....09	CCMT 09T3__ NFP	CCGW 09T3__	-	BFTX0409N	3,4	TRX15		
S.....12	CCMT 1204__ NFP	CCGW 1204__	-	BFTX0511N	5,0	TRX20		

Boring Bars for pos. insert





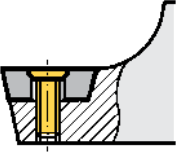
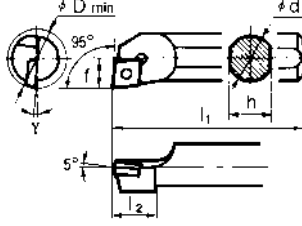
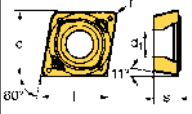
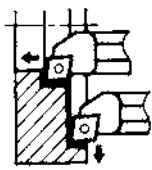
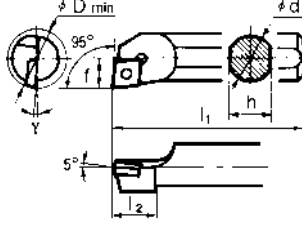
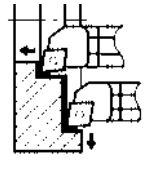
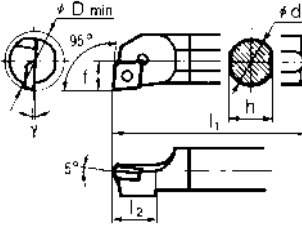

## ■ Holders

 Tool holders (S type) with screw-lock system		Cat. No.	Stock		Dimensions (mm)							
			R	L	$\phi D_{min}$	d	h	$l_1$	$l_2$	f	$\gamma$	
<b>S - SCLP R/L</b> Steel shank 		S10K - SCLP R/L 08	●	●	12	10	9	125	12	6	-5°	CP_T 0802__
		S12M - SCLP R/L 08	●	●	16	12	11	150	15	8	-3°	
		S16R - SCLP R/L 09		●	20	16	15	200	18	10	-3°	CP_T 0903__
		S20S - SCLP R/L 09	●	●	25	20	18	250	18	12,5	0	
		S25T - SCLP R/L 12	○	○	28	25	22	300	17,4	14	-3°	CP_T 1204__
<b>C - SCLP R/L</b> Carbide shank 		C10Q - SCLP R/L 08	●		12	10	9	180	15	6	-5°	CP_T 0802__
		C12R - SCLP R/L 08			16	12	11	200	15	8	-2°	
		C16S - SCLP R/L 09	●		20	16	15	250	15	10	-2°	CP_T 0903__

All figures show right hand tools.

## ■ Applicable Inserts

## ■ Spare Parts

Holder	Carbides, Cermets	CBN	Screw	 (N·m)	Wrench				
S/C-SCLP R/L									
S/C 10.....08	CPGT 0802__ NSD	CPMW 0802__	BFTX 0305 A	-	TRX 10				
S/C 12.....08	CPGT 0802__ NSD	CPMW 0802__	BFTX 0305 A	-	TRX 10				
S/C 16.....09	CPGT 0903__ NSD	CPMW 0903__	BFTX 0407 A	3,4	TRX 15				
S 20.....09	CPGT 0903__ NSD	CPMW 0903__	BFTX 0407 A	3,4	TRX 15				
S 25.....12	CPGT 1204__ NSD	-	BFTX 0509 A	5,0	TRX 20				



# Boring Bars B/D/S...SDUC Type

For Positive DC \_\_ - Inserts ( $\alpha = 7^\circ$ )

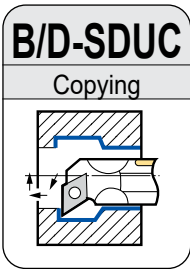
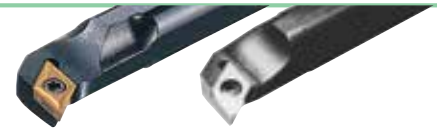

**B Type** (Fig.1)  
Min. Bore Dia.

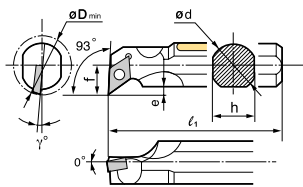

**D Type** (Fig.2)

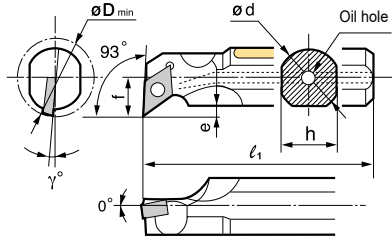

Insert (ex.)



### ■ Spare Parts

DC□T 0702□□	BFTX02506N 1,5 (N·m)
DC□T 11T3□□	BFTX0409N 3,4 (N·m)

### ■ Holders

Steel shank	Cat. No.	Stock		$\phi D_{min}$	Dimensions (mm)						Fig.	Insert (ex.)	Screw	Wrench
		R	L		$\phi d$	h	$\ell_1$	f	e	$\gamma$				
Anti-vibration B type	B10M - SDUC R/L 0702-13	●	●	13	10	9	150	7	2,5	-8°	1.	DC□T 0702□□	BFTX02506N 1,5 (N·m)	TRX08
Anti-vibration D type with oil hole	D12M - SDUC R/L 0702-16	●	●	16	12	11	150	9	3,5	-8°	2.			
	D16R - SDUC R/L 0702-20	●	●	20	16	15	200	11	4,0	-6°				
	D20S - SDUC R/L 11T3-25	●	●	25	20	18	250	13	4,5	-6°				
	D25S - SDUC R/L 11T3-32	●	●	32	25	22	250	17	7,0	-6°				
	D32T - SDUC R/L 11T3-40	●	●	40	32	30	300	22	8,0	-6°				

All figures show right hand tools.

Remarks: Right handed tool holders are applicable with left handed or neutral inserts.  
Left handed tool holders are applicable with right handed or neutral inserts.

### ■ Holders

	Tool holders (S type) with screw-lock system	Cat. No.	Stock		Dimensions (mm)							
			R	L	$\phi D_{min}$	d	h	$\ell_1$	f	e		$\gamma$
<b>S - SDUC R/L</b>		S10K - SDUC R/L 07	●	●	13	10	9	125	7	2,5	-8°	DC__ 0702__
		S12M - SDUC R/L 07	●	●	16	12	11	150	9	3,5	-8°	
		S16R - SDUC R/L 07	●	●	20	16	15	200	11	4	-6°	
		S20S - SDUC R/L 11	●	●	25	20	18	250	13	4,5	-6°	DC__ 11T3__
		S25T - SDUC R/L 11	●	●	32	25	22	300	17	7,5	-6°	
		S32U - SDUC R/L 11	●	●	40	32	30	350	22	11	-6°	

All figures show right hand tools.

### ■ Applicable Inserts

### ■ Spare Parts

Holder	Carbides, Cermets		CBN, PCD	Screw	(N·m)	Wrench			
S - SDUC R/L S - SDQC R/L									
S10K.....07	DCMT 0702__ NFP	DCMT 0702__ NSK	DCGW 0702__	BFTX02506N	1,5	TRX08			
S12M.....07	DCMT 0702__ NFP	DCMT 0702__ NSK	DCGW 0702__	BFTX02506N	1,5	TRX08			
S16R.....07	DCMT 0702__ NFP	DCMT 0702__ NSK	DCGW 0702__	BFTX02506N	1,5	TRX08			
S.....11	DCMT 11T3__ NFP	DCMT 11T3__ NSK	DCGW 11T3__	BFTX0409N	3,4	TRX15			

Boring Bars for pos. insert

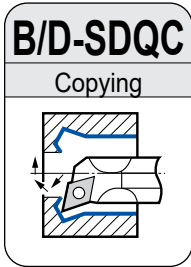

**B Type** (Fig.1)  
Min. Bore Dia.

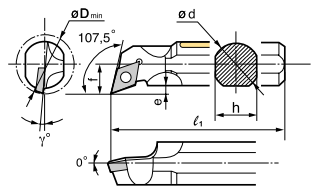

**D Type** (Fig.2)

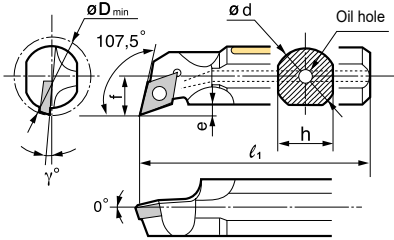

Insert (ex.)



■ Spare Parts

Screw	Wrench
BFTX02506N 1,5 $\text{C}_{(Nm)}$	TRX08
BFTX0409N 3,4 $\text{C}_{(Nm)}$	TRX15

■ Holders

Steel shank	Cat. No.	Stock		Dimensions (mm)							Fig.	Insert (ex.)	Screw	Wrench
		R	L	$\phi D_{min}$	$\phi d$	h	$\ell_1$	f	e	$\gamma$				
Anti-vibration B type	B10M - SDQC R/L 0702-13	●	●	13	10	9	150	7	2,5	-8°	1.	DCIT 070200	BFTX02506N 1,5 $\text{C}_{(Nm)}$	TRX08
Anti-vibration D type with oil hole	D12M - SDQC R/L 0702-16	●	●	16	12	11	150	9	3,5	-8°	2.			
	D16R - SDQC R/L 0702-20	●	●	20	16	15	200	11	4,0	-6°				
	D20S - SDQC R/L 11T3-25	●	●	25	20	18	250	13	4,5	-6°				
	D25S - SDQC R/L 11T3-32	●	●	32	25	22	250	17	7,0	-6°				
	D32T - SDQC R/L 11T3-40	●	●	40	32	30	300	22	7,0	-10°				

All figures show right hand tools.

Remarks: Right handed tool holders are applicable with left handed or neutral inserts.  
Left handed tool holders are applicable with right handed or neutral inserts.

■ Holders

Tool holders (S type) with screw-lock system	Cat. No.	Stock		Dimensions (mm)							Fig.
		R	L	$\phi D_{min}$	d	h	$\ell_1$	f	e	$\gamma$	
<p>S - SDQC R/L</p>	S10K - SDQC R/L-07	●	●	13	10	9	125	7	2,5	-8°	DC__ 0702__
	S12M - SDQC R/L-07	●	●	16	12	11	150	9	3,5	-8°	
	S16R - SDQC R/L-07	●	●	20	16	15	200	11	4	-6°	
	S20S - SDQC R/L-11	●	●	25	20	18	250	13	4,5	-6°	DC__ 11T3__
	S25T - SDQC R/L-11	●	●	32	25	22	300	17	7	-6°	

All figures show right hand tools.

■ Applicable Inserts

■ Spare Parts

Holder	Carbides, Cermets		CBN, PCD	Screw	$\text{C}_{(Nm)}$	Wrench			
S - SDUC R/L S - SDQC R/L									
S10K.....07	DCMT 0702__ NFP	DCMT 0702__ NSK	DCGW 0702__	BFTX02506N	1,5	TRX08			
S12M.....07	DCMT 0702__ NFP	DCMT 0702__ NSK	DCGW 0702__	BFTX02506N	1,5	TRX08			
S16R.....07	DCMT 0702__ NFP	DCMT 0702__ NSK	DCGW 0702__	BFTX02506N	1,5	TRX08			
S.....11	DCMT 11T3__ NFP	DCMT 11T3__ NSK	DCGW 11T3__	BFTX0409N	3,4	TRX15			

Boring Bars  
for pos. Insert

# Boring Bars S/C...SSKP Type

For Positive SP\_\_ - Inserts ( $\alpha = 11^\circ$ )

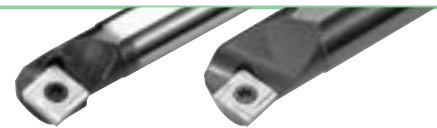

## ■ Holders

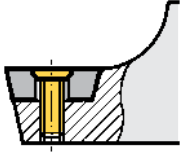
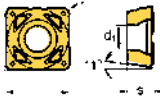
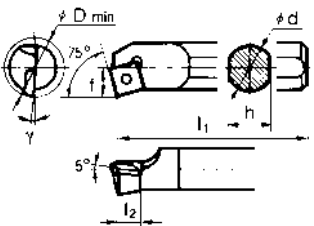
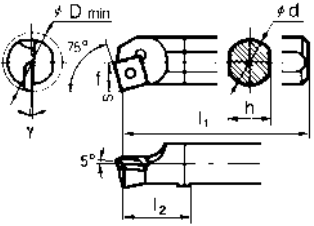



	Tool holders (S type) with screw-lock system	Cat. No.	Stock		Dimensions (mm)						
			R	L	$\phi D_{min}$	d	h	$l_1$	$l_2$	f	
<b>S - SSKP R/L</b> Steel shank  	S12M - SSKP R/L 09	○	16	12	11	150	9	8	-6°	SP_T 0903__	
	S16R - SSKP R/L 09	●	20	16	15	200	6,8	10	-4°		
	S20S - SSKP R/L 09	●	25	20	18	250	8,5	12,5	-2°		
	S25T - SSKP R/L 09	●	28	25	22	300	5	14	0		
<b>C - SSKP R/L</b> Carbide shank  	C12R - SSKP R/L 09	●	16	12	11	200	25	8	-6°	SP_T 0903__	
	C16S - SSKP R/L 09	●	20	16	15	250	30	10	-4°		

All figures show right hand tools.

Remarks: Right handed tool holders are applicable with left handed or neutral inserts.  
Left handed tool holders are applicable with right handed or neutral inserts.  
SPGT figure shows left hand tool.

## ■ Applicable Inserts

## ■ Spare Parts

Holder	Carbides, Cermets	CBN	Screw	$\overset{\curvearrowright}{(N\cdot m)}$	Wrench			
S/C-SSKP R/L								
S/C 12.....09	SPGT 0903__ L/R-SD	SPGW 0903__	BFTX 0307 A	2,0	TRX 10			
S/C 16.....09								
S 20.....09								
S 25.....09								



## ■ Holders

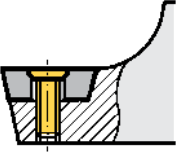
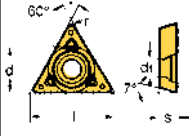
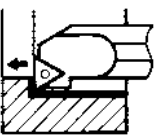
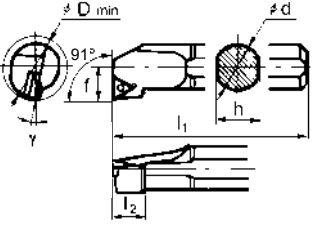

	Tool holders (S type) with screw-lock system	Cat. No.	Stock		Dimensions (mm)							
			R	L	$\phi D_{min}$	d	h	$l_1$	$l_2$	f	$\gamma$	
<b>S - STFC R/L</b>  	S10K - STFC R/L 09	● ●	13	10	9	125	-	10,5	-12°	TC__0902__		
	S12M - STFC R/L 11	● ●	16	12	11	150	10	9	-10°	TC__1102__		
	S16R - STFC R/L 11	● ●	20	16	15	200	12	11	-6°			
	S20S - STFC R/L 11	● ●	25	20	18	250	14	13	-3°			
	S25T - STFC R/L 16	●	32	25	23	300	18	17	-6°	TC__16T3__		
	S32U - STFC R/L 16	●	40	32	30	350	20	22	-10°			
	S40V - STFC R/L 16		50	40	37	400	25	27	-8°			

All figures show right hand tools.

Boring Bars  
for pos. Insert

## ■ Applicable Inserts

## ■ Spare Parts

Holder	Carbides, Cermets		CBN, PCD	Screw	$\curvearrowright$ (N·m)	Wrench			
S - STFC R/L									
S.....09	TCMT 0902__ NFP	-	TCGW 0902__	BFTX02205N	0,5	TRX06			
S.....11	TCMT 1102__ NFP	TCMT 1102__ NSK	TCGW 1102__	BFTX02506N	1,5	TRX08			
S.....16	TCMT 16T3__ NFP	TCMT 16T3__ NSK	TCGW 16T3__	BFTX0409N	3,4	TRX15			

# Boring Bars B/D/S/C...STUP(B) Type

For Positive TB / TP \_\_\_ - Inserts ( $\alpha = 5, 11^\circ$ )

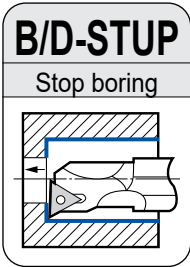

**B Type** (Fig.1)  
Min. Bore Dia.

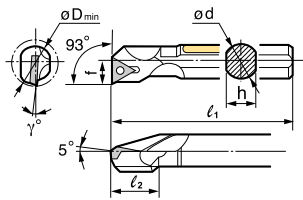

**D Type** (Fig.2)

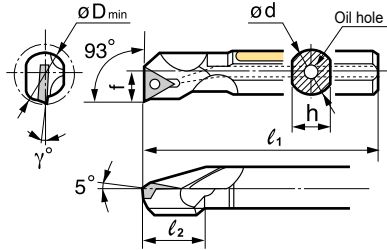

Insert (ex.)



## Spare Parts



## ■ Holders

Steel shank	Cat. No.	Stock		$\phi D_{min}$	Dimensions (mm)						Fig.	Insert (ex.)	Screw	Wrench
		R	L		$\phi d$	h	$l_1$	f	$l_2$	$\gamma$				
Anti-vibration B type	B08H - STUP R/L 0802-10	●	●	10	8	7	100	5	13	-10°	1.	TP□T 0802□□	BFTX0204A $\leq 0.5$	TRX06
	B10K - STUP R/L 1103-12	●	●	12	10	9	125	6	15	-8°				
Anti-vibration D type with oil hole	D12M - STUP R/L 1103-14	●	●	14	12	11	150	7	17	-7°	2.	TP□T 1103□□	BFTX0306A $\leq 2.0$	TRX10
	D16R - STUP R/L 1103-18	●	●	18	16	15	200	9	18	-4°				
	D20S - STUP R/L 1103-22	●	●	22	20	18	250	11	18	-3°				
	D25T - STUP R/L 1604-28	●	●	28	25	22	300	14	18	-2°				
	D32T - STUP R/L 1604-40	●	●	40	32	30	300	20	13	-2°				
											TP□T 1604□□	BFTX0307A $\leq 2.0$		
												BFTX0410A $\leq 3.4$	TRX15	

All figures show right hand tools.

Remarks: Right handed tool holders are applicable with left handed or neutral inserts.  
Left handed tool holders are applicable with right handed or neutral inserts.

## ■ Holders

Tool holders (S type) with screw-lock system	Cat. No.	Stock		Dimensions (mm)							Fig.
		R	L	$\phi D_{min}$	d	h	$l_1$	$l_2$	f	$\gamma$	
<b>S - STUP/B R/L</b> Steel shank 	S08H - STUP R/L 06-01	●	●	8	8	7	100	30	4	-12°	
	S08H - STUP R/L 08-02	●	●	10	8	7	100	13	5	-10°	
	S10K - STUP R/L 11-03	●	●	12	10	9	125	15	6	-8°	
	S12M - STUP R/L 11-03	●	●	16	12	11	150	17	8	-6°	
	S16R - STUP R/L 11-03			20	16	15	200	18	10	-2°	
	S20S - STUP R/L 16			25	20	18	250	18	12,5	-3°	
	S25T - STUP R/L 16	●	●	28	25	22	300	18	14	-2°	
<b>C - STUP/B R/L</b> Carbide shank 	C08M - STUP R/L 06	●	●	8	8	7	150	50	4	-12°	
	C08M - STUP R/L 08	●	●	10	8	7	150	18	5	-10°	
	C10Q - STUP R/L 11	●	●	12	10	9	180	19	6	-8°	
	C12R - STUP R/L 11	●	●	16	12	11	200	25	8	-6°	
	C16S - STUP R/L 11	●	●	20	16	15	250	30	10	-4°	

## ■ Applicable Inserts

## ■ Spare Parts

Holder	Carbides, Cermets	CBN, PCD	Screw	$\leq$ (N·m)	Wrench
S/C-STU_ R/L					
S/C 08.....06-01	TBGT 0601_ L/R-W	-	BFTX 0204 A	0,5	TRX 06
S/C 08.....08-02	TPGT 0802_ L/R-W	TPMW 0802_	BFTX 0204 A	0,5	TRX 06
S/C 10.....11-03	TPGT 1103_ L/R-W	TPGW 1103_	BFTX 0306 A	2,0	TRX 10
S/C 12/16.....11-03	TPGT 1103_ L/R-W	TPGW 1103_	BFTX 0307 A	2,0	TRX 10
S 20/25.....16	TPGT 1604_ L/R-W	TPGW 1604_	BFTX 0410 A	3,4	TRX 15

Boring Bars for pos. insert



Anti-vibration D type  
with oil hole

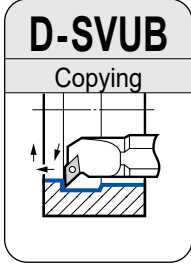

Fig.1

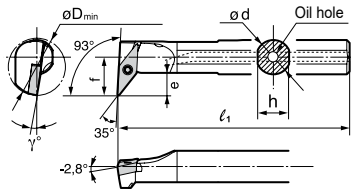
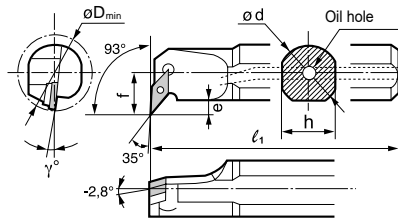

Fig.2



Insert (ex.)



### ■ Spare Parts

	Pin	Clamp screw	Shim	Screw	Wrench	Wrench
D16R - SVUB R/L 1103-22	-	-	-	BFTX02508NV	TRX08	-
D20S - SVUB R/L 1103-27	-	-	-	BFTX03508	TRX10	-
D25T - SVUB R/L 1604-35	-	-	-	BFTX03508	TRX10	-
D32T - SVUB R/L 1604-40	VP32B	BH03504	SVP32	2.0	TRX10	LH020

### ■ Holders

Above figures show right hand tools.

Cat. No.	Stock		$\phi D_{min}$	Dimensions (mm)						Fig.	Insert (ex.)	Pin	Clamp screw	Shim	Screw	Wrench	Wrench
	R	L		$\phi d$	h	$\ell_1$	f	e	$\gamma$								
D16R - SVUB R/L 1103-22	●	●	22	16	15	200	13	5	-7°	1.	VB□□ 1103○○	-	-	-	BFTX02508NV	TRX08	-
D20S - SVUB R/L 1103-27	●	●	27	20	18	250	15	5	-5°	1.	VB□□ 1103○○	-	-	-	BFTX03508	TRX10	-
D25T - SVUB R/L 1604-35	●	●	35	25	23	300	20,5	9	-7,5°	2.	VB□□ 1604○○	-	-	-	BFTX03508	TRX10	-
D32T - SVUB R/L 1604-40	●	●	40	32	30	300	22	9	-7,5°	2.	VB□□ 1604○○	VP32B	BH03504	SVP32	2.0	TRX10	LH020

Remarks: Right handed tool holders are applicable with left handed or neutral inserts.  
Left handed tool holders are applicable with right handed or neutral inserts.



Anti-vibration D type  
with oil hole

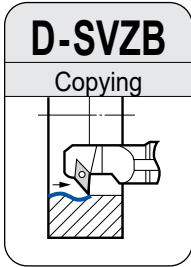

Fig.1

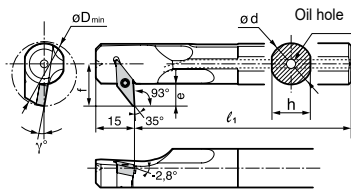
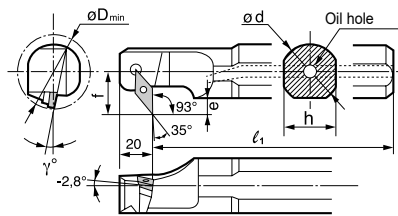

Fig.2



Insert (ex.)



### ■ Spare Parts

	Pin	Clamp screw	Shim	Screw	Wrench	Wrench
D16R - SVZB R/L 1103-22	-	-	-	BFTX02508NV	TRX08	-
D20S - SVZB R/L 1103-27	-	-	-	BFTX03508	TRX10	-
D25T - SVZB R/L 1604-35	-	-	-	BFTX03508	TRX10	-
D32T - SVZB R/L 1604-40	VP32B	BH03504	SVP32	2.0	TRX10	LH020

### ■ Holders

Above figures show right hand tools.

Cat. No.	Stock		$\phi D_{min}$	Dimensions (mm)						Fig.	Insert (ex.)	Pin	Clamp screw	Shim	Screw	Wrench	Wrench
	R	L		$\phi d$	h	$\ell_1$	f	e	$\gamma$								
D16R - SVZB R/L 1103-22	●	●	22	16	15	200	13	5	-7°	1.	VB□□ 1103○○	-	-	-	BFTX02508NV	TRX08	-
D20S - SVZB R/L 1103-27	●	●	27	20	18	250	15	5	-5°	1.	VB□□ 1103○○	-	-	-	BFTX03508	TRX10	-
D25T - SVZB R/L 1604-35	●	●	35	25	23	300	20,5	9	-7,5°	2.	VB□□ 1604○○	-	-	-	BFTX03508	TRX10	-
D32T - SVZB R/L 1604-40	●	●	40	32	30	300	22	9	-7,5°	2.	VB□□ 1604○○	VP32B	BH03504	SVP32	2.0	TRX10	LH020





# Boring Bars S...SVQB / SVUB, SVZB Type

For Positive VB\_\_ - Inserts ( $\alpha = 5^\circ$ )



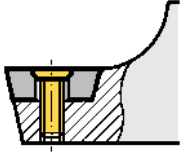

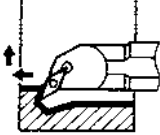
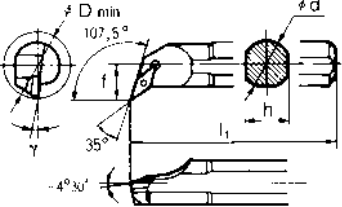
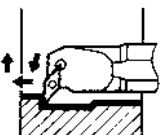
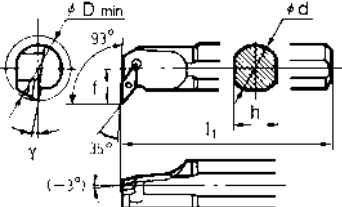
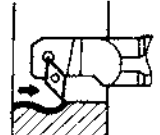
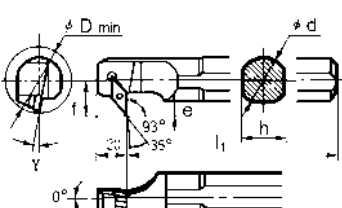





## ■ Holders

	Tool holders (S type) with screw-lock system	Cat. No.	Stock		Dimensions (mm)							
			R	L	$\phi D_{min}$	d	h	$l_1$	f	$\gamma$	e	
<b>S - SVQB R/L</b> 		S16R - SVQB R/L 11	●	●	22	16	15	200	13	-6,5°		VB__ 1102__
		S20S - SVQB R/L 11	●	●	27	20	18	250	15	-6,5°		
		S25T - SVQB R/L 16	●	●	35	25	23	300	20,5	-6,5°		VB__ 1604__
		S32U - SVQB R/L 16	●	●	40	32	30	350	22	-6,5°		
		S40V - SVQB R/L 16			50	40	37	400	27	-6,5°		
<b>S - SVUB R/L</b> 		S16R - SVUB R/L 11	●	●	22	16	15	200	13	-7,5°		VB__ 1102__
		S20S - SVUB R/L 11	●	●	27	20	18	250	15	-7,5°		
		S25T - SVUB R/L 16	●	●	35	25	23	300	20,5	-7,5°		VB__ 1604__
		S32U - SVUB R/L 16	●	●	40	32	30	350	22	-7,5°		
		S40V - SVUB R/L 16			50	40	37	400	27	-7,5°		
<b>S - SVZB R/L</b> 		S16R - SVZB R/L 11	●	●	22	16	15	200	13	-7,5°	5	VB__ 1102__
		S20S - SVZB R/L 11	●	●	27	20	18	250	15	-7,5°	5	
		S25T - SVZB R/L 16	●	●	35	25	23	300	20,5	-7,5°	9	VB__ 1604__
		S32U - SVZB R/L 16	●	●	40	32	30	350	22	-7,5°	9	

All figures show right hand tools.

## ■ Applicable Inserts

## ■ Spare Parts

Holder	Carbides, Cermets		CBN	Pin	Clamp bolt	Shim	Screw	Wrench	Wrench
									
S16R	VBMT 1102__ NFP	VBMT 1102__ NSK	-	-	-	-	BFTX02506N	TRX08	-
S20S	VBMT 1102__ NFP	VBMT 1102__ NSK	-	-	-	-	⊕ 1,5	TRX08	-
S25T	VBMT 1604__ NFP	VBMT 1604__ NSK	VBGW 1604__	-	-	-	BFTX03508 ⊕ 2,0	TRX10	-
S32U	VBMT 1604__ NFP	VBMT 1604__ NSK	VBGW 1604__	VP32B	BH03504	SVP32		TRX10	LH020
S40V	VBMT 1604__ NFP	VBMT 1604__ NSK	VBGW 1604__	VP40B	BH03504	SVP32	TRX10	LH020	

● = Euro stock

 Recommended Tightening Torque (N·m)

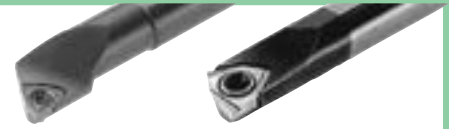

## ■ Holders

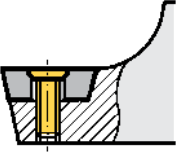
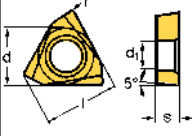
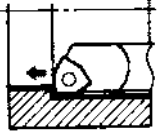
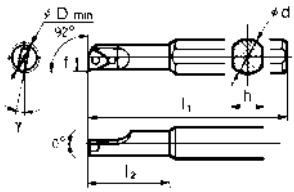
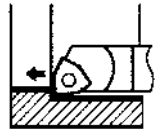
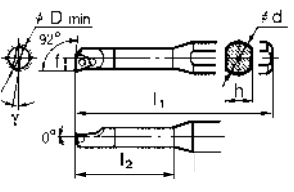

 Tool holders (S type) with screw-lock system	Cat. No.	Stock		Dimensions (mm)							
		R	L	$\phi D_{min}$	d	h	$l_1$	$l_2$	f	$\gamma$	
<b>S - SWUB R/L</b> Steel shank 	S08H - SWUB R/L 06-01	●	●	5,5	8	7	100	18	3	-12°	WBGT 0601__
											
<b>C - SWUB R/L</b> Carbide shank 	C08K - SWUB R/L 06		●	5,5	8	7	125	30	3	-12°	WBGT 0601__
											

All figures show right hand tools.

Remarks: Right handed tool holders are applicable with left handed or neutral inserts.  
Left handed tool holders are applicable with right handed or neutral inserts.

## ■ Applicable Inserts

## ■ Spare Parts

Holder	Carbides, Cermets	CBN	Screw	$\text{N}\cdot\text{m}$	Wrench				
S/C-SWUBR/L									
S/C 08.....R 06	WBGT 0601__ LW	-	BFTX 0203 N	0,5	TRX 06				
S/C 08.....L 06	WBGT 0601__ RW	-	BFTX 0203 N	0,5	TRX 06				

# Solid Carbide Boring Bars BXBR Type



**SumiSmall**

## ■ Characteristics

- Economical, two-cornered insert.
- Maximum boring depth 5D (5 times the shank diameter)
- Usable at any desired overhang.
- Shank size = min. bore diameter for easy selection.  
(Available from  $\phi$  2 mm to  $\phi$  5 mm in 0,5 mm increments.)
- KBMX Type cutting edge used, no breaker versions also available in stock.

## Small Hole Finishing

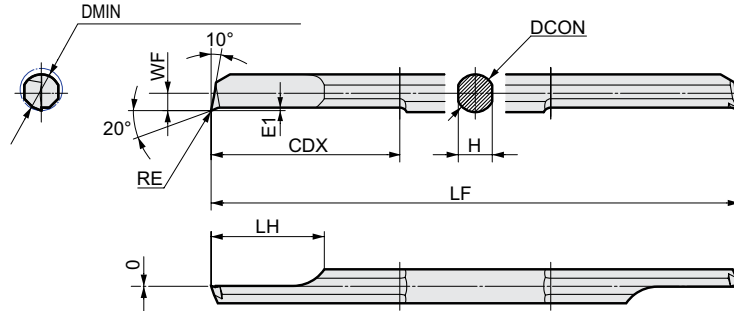
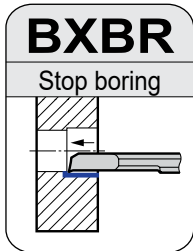

Figure shows tool with breaker.

## ■ Solid Carbide Bar

	Cat. No.	Stock		DMIN	Dimensions (mm)								Applicable Sleeve
		ACZ150	AC530U		DCON	H	LF	WF	LH	CDX	E1	RE	
With Breaker	BXBR 02005 R	○		2,0	2,0	1,8	50	0,80	6,0	10,0	0,20	0,05	HBX 2016
	02020 R	○		2,0	2,0	1,8	50	0,80	6,0	10,0	0,20	0,20	HBX 2016
	BXBR 02505 R	○		2,5	2,5	2,2	50	1,05	7,5	12,5	0,20	0,05	HBX 2516
	02520 R	○		2,5	2,5	2,2	50	1,05	7,5	12,5	0,20	0,20	HBX 2516
	BXBR 03005 R	○		3,0	3,0	2,7	50	1,30	9,0	15,0	0,25	0,05	HBX 3016
	03020 R	○		3,0	3,0	2,7	50	1,30	9,0	15,0	0,25	0,20	HBX 3016
	BXBR 03505 R	○		3,5	3,5	3,1	60	1,55	10,5	17,5	0,25	0,05	HBX 3516
	03520 R	○		3,5	3,5	3,1	60	1,55	10,5	17,5	0,25	0,20	HBX 3516
	BXBR 04005 R	○		4,0	4,0	3,6	60	1,80	12,0	20,0	0,35	0,05	HBX 4016
	04020 R	○		4,0	4,0	3,6	60	1,80	12,0	20,0	0,35	0,20	HBX 4016
No Breaker	BXBR 04505 R	○		4,5	4,5	4,1	70	2,05	13,5	22,5	0,35	0,05	HBX 4516
	04520 R	○		4,5	4,5	4,1	70	2,05	13,5	22,5	0,35	0,20	HBX 4516
	BXBR 05005 R	○		5,0	5,0	4,5	70	2,30	15,0	25,0	0,40	0,05	HBX 5016
	05020 R	○		5,0	5,0	4,5	70	2,30	15,0	25,0	0,40	0,20	HBX 5016
	BXBR 02005 R-NB		○	2,0	2,0	1,8	50	0,80	6,0	10,0	0,20	0,05	HBX 2016
	02020 R-NB		○	2,0	2,0	1,8	50	0,80	6,0	10,0	0,20	0,20	HBX 2016
	BXBR 02505 R-NB			2,5	2,5	2,2	50	1,05	7,5	12,5	0,20	0,05	HBX 2516
	02520 R-NB		○	2,5	2,5	2,2	50	1,05	7,5	12,5	0,20	0,20	HBX 2516
	BXBR 03005 R-NB		○	3,0	3,0	2,7	50	1,30	9,0	15,0	0,25	0,05	HBX 3016
	03020 R-NB		○	3,0	3,0	2,7	50	1,30	9,0	15,0	0,25	0,20	HBX 3016
BXBR 03505 R-NB			3,5	3,5	3,1	60	1,55	10,5	17,5	0,25	0,05	HBX 3516	
03520 R-NB		○	3,5	3,5	3,1	60	1,55	10,5	17,5	0,25	0,20	HBX 3516	
BXBR 04005 R-NB		○	4,0	4,0	3,6	60	1,80	12,0	20,0	0,35	0,05	HBX 4016	
04020 R-NB		○	4,0	4,0	3,6	60	1,80	12,0	20,0	0,35	0,20	HBX 4016	
BXBR 04505 R-NB		○	4,5	4,5	4,1	70	2,05	13,5	22,5	0,35	0,05	HBX 4516	
04520 R-NB		○	4,5	4,5	4,1	70	2,05	13,5	22,5	0,35	0,20	HBX 4516	
BXBR 05005 R-NB		○	5,0	5,0	4,5	70	2,30	15,0	25,0	0,40	0,05	HBX 5016	
05020 R-NB		○	5,0	5,0	4,5	70	2,30	15,0	25,0	0,40	0,20	HBX 5016	

## ■ Adaptor Sleeve (Optional)

	Cat. No.	Stock	DCB (mm)	Applicable Bar
	HBX 2016	○	2,0	BXBR 02000 R(-NB)
	HBX 2516	○	2,5	BXBR 02500 R(-NB)
	HBX 3016	○	3,0	BXBR 03000 R(-NB)
	HBX 3516	○	3,5	BXBR 03500 R(-NB)
	HBX 4016	○	4,0	BXBR 04000 R(-NB)
	HBX 4516	○	4,5	BXBR 04500 R(-NB)
	HBX 5016	○	5,0	BXBR 05000 R(-NB)

\* BXBR bars can be used with HBB type sleeves. Commercially available sleeves may also be used.

## ■ Spare Parts (For sleeve)

Screw	(N·m)	Setting Screw	Wrench
BFTX 0409 N	3,4	BT 06035 T	TRD 15

# Grooving & Parting-Off Threading Holders

F1-F70

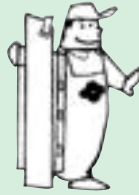

GND Type Grooving Tools Selection Guide	<b>Expansion</b> GND .....	F 2-17
External Grooving, for Small Lathes	<b>Expansion</b> GNDM / GNDL .....	F18
Internal Grooving, for Small Lathes	<b>Expansion</b> GNDM-J / GNDL-J <b>New</b> .....	F20
For Shallow Grooves	<b>Expansion</b> GNDS .....	F22
External Multi Purpose/L-Styled Holder	<b>Expansion</b> GNDM / GNDMS .....	F24
External Multi Purpose Grooving/Internal Coolant	<b>Expansion</b> GNDM JE .....	F26
External Deep Grooving and Cut-Off	<b>Expansion</b> GNDL / GNDLS .....	F28
External Deep Grooving and Cut-Off/Internal Coolant	<b>Expansion</b> GNDL JE .....	F30
Necking	<b>Expansion</b> GNDN .....	F32
Face Grooving/L-Styled Holder	<b>Expansion</b> GNDF / GNDFS .....	F34
Internal Grooving/L-Styled Holder	<b>Expansion</b> GNDI / GNDIS .....	F38
Internal Grooving for Small Diameters	<b>New</b> SSH-Series .....	F42-44
ISO-PSC Polygon Modular Grooving System Holders	<b>Expansion</b> PSC-GNDCM .....	F46
ISO-PSC Polygon Modular Grooving System Inserts	<b>Expansion</b> PSC-GNDCF .....	F48
"SumiTurn B-Groove" Holders	GWCS / GWCS .....	F50
"SumiTurn B-Groove" Inserts	PSC / GWCI / TGA-BF .....	F51
"SumiTurn B-Groove" Inserts	<b>Expansion</b> TGA R/L (E) .....	F52
"SumiTurn B-Groove" Inserts	<b>Expansion</b> TGA R/L R, TGA R/L T .....	F53
Parting-Off Mini Holders	SCT .....	F54
Sumi-Grip	.....	F55
"Sumi-Grip Jr." Steel Type	STFH / STFS R/L .....	F56
Sumi-Grip Jr. Inserts	WCF (NTL) .....	F57
"Sumi-Grip" Carbide Blade Type	WCFH / WCFR R/L .....	F58
Sumi-Grip Inserts	WCF (NTL) <b>New</b> .....	F60
Threading Tools	SSTE / SSTI .....	F62-69
Inserts for External Threading Holders	SSTE .....	F64
Inserts for Internal Threading Holders	SSTI .....	F65

# Grooving Tool Holders GND Series



**New**

New series of internal coolant-type holders for small lathes

## Cutting Performance

### Eliminates Vibration

Reduces vibration up to 30 % compared to conventional grades thanks to its high-rigidity design.

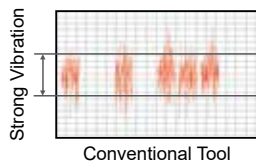
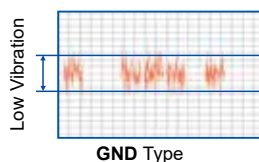
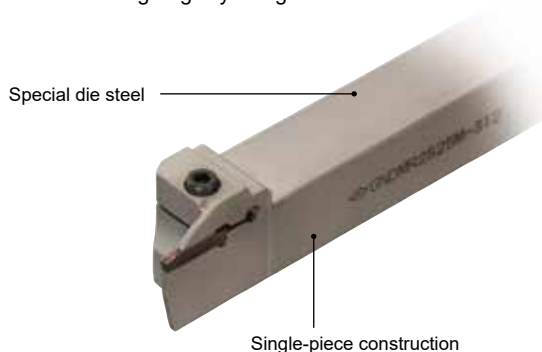

Work Material: 15CrMo5  
Holder: GNDL R2525M 220  
Insert: GCM N2002 GG  
Cutting Conditions:  $v_c = 100$  m/min,  $f = 0,10$  mm/rev,  $a_p = 20$  mm, wet

## Characteristics

- Wide range of application processes  
Applicable for grooving, turning, copying, facing, boring and cut-off.
- Achieving stable tool life  
An array of chipbreakers improves the efficiency in chip control in various applications and prevents unexpected damages caused by chip blockade.
- Achieving smooth cutting and high efficiency machining  
Holders utilizing one-piece body construction made of special steel, reduce vibration by 30 % during machining as compared to conventional types.
- Achieving high precision grooving widths with moulded inserts  
Grooving insert width tolerance of  $\pm 0,03$  mm over the entire range

Ensures both, high rigidity and good chip evacuation

### Internal

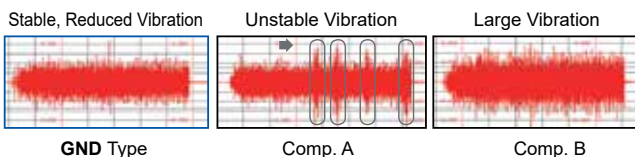

Work Material: 15CrMo5  
Holder: GNDI R2532 T306  
Insert: GCM N3002 GG  
Cutting Conditions:  $v_c = 100$  m/min,  $f = 0,05$  mm/rev,  $a_p = 3,0$  mm, wet

## Application Examples

Substantially improved machining efficiency!

High rigidity holder enables high load machining at high feed rate.

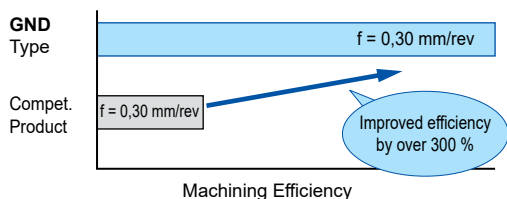

Work Material: 42CrMo4  
Holder: GNDL R2525M 320  
Insert: GCM N3002 GG (AC530U)  
Cutting Conditions:  $v_c = 130$  m/min,  $f = 0,30$  mm/rev, wet

Stable and long tool life ensures reliable functionality even on automatic production lines!

Reduction of chattering prevents unexpected breakage.



Work Material: C53  
Holder: GNDM L2525M 618  
Insert: GCM N6030 RG (AC530U)  
Cutting Conditions:  $v_c = 130$  m/min,  $f = 0,30$  mm/rev, wet



# Grooving Tool Holders GND Series

## Internal Coolant Grooving Tool Holder GNDM-J(E) / GNDL-J(E) Type and Grade-Expansion

**New** **Expansion**

- Newly developed 2-hole coolant design optimizes cooling of the insert and improves chip removal, extending tool life and allowing for improved speeds and feeds in production.
- Grooving width range from 2,0 to 6,0 mm
- Introducing new holders for small lathes with grooving width of 2,0 to 3,0 mm
- Achieves both high efficiency in high speed machining and extension of tool life due to internal coolant supply to the cutting edge.
- Improves chip control by applying direct coolant from cutting edge side.
- 4 more grades **AC8025P**, **AC8035P**, **AC5015S** and **AC5025S** available.
- The new grades expand the application in steel materials in direction of high speed with the grade **AC8025P** and for more toughness with the grade **AC8035P**.
- In the area for machining heat-resistance alloys and exotic alloys as Inconel and Hastelloy, we recommend the grade **AC5025S** as the first choice and the grade **AC5015S** for high-speed machining in continues cut.



## Wear Resistance

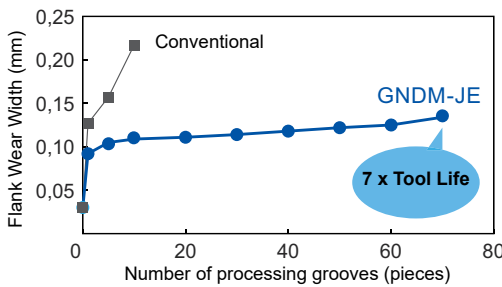

Upper coolant hole improves chip control.

Lower coolant hole improves wear resistance.



## Chip Control



Coolant Pressure: 7 MPA



Coolant Pressure: 1 MPA



External Coolant

Work Material:	Ti-6Al-4V
Holder:	GNDM R2525K 312JE
Insert:	GCM N3002 GG (AC530U)
Cutting Conditions:	$v_c = 60$ m/min, $f = 0,1$ mm/rev, $a_p = 5,0$ mm, wet

## CF Type Chipbreaker for Cut-Off

- Lead angle of  $10^\circ/15^\circ$  for improved sharpness in cut-off machining.
- Asymmetrical chipbreaker design provides excellent chip control even in difficult to machine conditions.



GCMN20003 CF 10



GCMN20003 CF 15



Competitor

Work Material:	St42-3
Holder:	GNDM R2525M 220
Insert:	GCM N3002 CF-10, 15 (AC1030U)
Cutting Conditions:	$n = 2000$ min <sup>-1</sup> , $f = 0,08$ mm/rev, wet



# Grooving Tool Holders

## GND Series

### ■ Inserts - Chipbreaker Series

Achieving stability and longer tool life. A variety of chipbreakers ensures outstanding chip control performance in many different types of applications.

Grooving / Turning			Grooving / Cut-Off			Cut-Off			Profiling			Necking			Non Ferrous Metals														
General Type		Low Feed Type	General Type		Low Feed Type	Low Cutting ForceType	Cut-Off Type		Low Cutting ForceType	General Type		General Type		General Type															
<b>MG</b>	<b>ML</b>	<b>GG</b>	<b>GL</b>	<b>GF</b>	<b>CG</b>	<b>CF</b>	<b>RG</b>	<b>RN</b>	<b>GA</b>																				
Cross Section of Cutting Edge			Cross Section of Cutting Edge			Cross Section of Cutting Edge			Cross Section of Cutting Edge			Cross Section of Cutting Edge			Cross Section of Cutting Edge														
Grooving Width (mm)			Grooving Width (mm)			Grooving Width (mm)			Grooving Width (mm)			Grooving Width (mm)			Grooving Width (mm)			Grooving Width (mm)			Grooving Width (mm)			Grooving Width (mm)					
1,25   1,5   2,0			1,25   1,5   2,0			1,25   1,5   2,0			1,25   1,5   2,0			1,25   1,5   2,0			1,25   1,5   2,0			1,25   1,5   2,0			1,25   1,5   2,0			1,25   1,5   2,0					
3,0   4,0   5,0			3,0   4,0   5,0			3,0   4,0   5,0			3,0   4,0   5,0			3,0   4,0   5,0			3,0   4,0   5,0			3,0   4,0   5,0			3,0   4,0   5,0			3,0   4,0   5,0					
6,0   7,0   8,0			6,0   7,0   8,0			6,0   7,0   8,0			6,0   7,0   8,0			6,0   7,0   8,0			6,0   7,0   8,0			6,0   7,0   8,0			6,0   7,0   8,0			6,0   7,0   8,0					
Grade		Grade	Grade		Grade	Grade		Grade	Grade		Grade		Grade		Grade		Grade		Grade		Grade		Grade						
AC8025P		AC8035P	AC8025P		AC8035P	AC8025P		AC8035P	AC8025P		AC8035P		AC8025P		AC8035P		AC8025P		AC8035P		AC8025P		AC8035P						
AC830P		AC425K	AC830P		AC425K	AC830P		AC425K	AC830P		AC425K		AC830P		AC425K		AC830P		AC425K		AC830P		AC425K						
AC5015S		AC5025S	AC5015S		AC5025S	AC5015S		AC5025S	AC5015S		AC5025S		AC5015S		AC5025S		AC5015S		AC5025S		AC5015S		AC5025S						
AC520U		AC530U	AC520U		AC530U	AC520U		AC530U	AC520U		AC530U		AC520U		AC530U		AC520U		AC530U		AC520U		AC530U						
AC1030U		T2500A	AC1030U		T2500A	AC1030U		T2500A	AC1030U		T2500A		AC1030U		T2500A		AC1030U		T2500A		AC1030U		T2500A						
H10		H10	H10		H10	H10		H10	H10		H10		H10		H10		H10		H10		H10		H10						

Stock
\* Only use with GNDIS

Grooving & Parting-Off

### ■ Recommended Cutting Conditions

Work Material	<b>P</b> Carbon Steel / Alloy Steel	<b>M</b> Stainless Steel	<b>K</b> Cast Iron	<b>S</b> Exotic Alloy	<b>N</b>								
Grade	AC830P AC8025P AC8035P	AC520U AC530U AC1030U	AC830P AC5015S AC5025S	AC425K AC520U AC530U AC1030U	AC520U AC5015S AC5025S AC530U AC1030U	H10							
Cutting Speed (m/min)	80-200	80-200	50-200	50-200	70-150	70-150	50-150	80-200	60-200	50-200	20-80	20-60	150-300

Please see cutting data page 13

### ■ Excellent Chip Control

**Grooving**



**GND Type**  
(GG Type Chipbreaker)



Conventional Tool

Work Material:	15CrMo5
Holder:	GNDL R2525M 320
Insert:	GCM N3002 GG
Cutting Conditions:	$v_c=100$ m/min, $f=0,15$ mm/rev, $a_p=12,0$ mm, wet

**Turning**



**GND Type**  
(ML Type Chipbreaker)



Conventional Tool

Work Material:	15CrMo5
Holder:	GNDM R2525M 312
Insert:	GCM N3002 ML
Cutting Conditions:	$v_c=100$ m/min, $f=0,10$ mm/rev, $a_p=0,5$ mm, wet

**Cut-Off**



**GND Type**  
(CG Type Chipbreaker)



Conventional Tool

Work Material:	X5CrMo17122 (Ø 30 mm)
Holder:	GNDL R2525M 220
Insert:	GCM R2002 CG 05
Cutting Conditions:	$v_c=100$ m/min, $f=0,15$ mm/rev, wet

**Profiling**



**GND Type**  
(RG Type Chipbreaker)















Conventional Tool

Work Material:	15CrMo5
Holder:	GNDM R2525M 312
Insert:	GCM N3015 RG
Cutting Conditions:	$v_c=100$ m/min, $f=0,15$ mm/rev, $a_p=0,1$ mm, wet

# Grooving Tool Holders GND Series

## Chipbreaker Selection

	Grooving / Turning	Grooving	Cut-Off
1st Recommendation	<b>MG</b> General Feed 	<b>GG</b> General Feed 	<b>GG</b> General Feed 
	Improved Chip Control Chipping Prevention	Improved Chip Control Chipping Prevention	Prevent Nip Formation Good Chip Control Improved Chip Control Chipping Prevention
2nd Recommendation	<b>ML</b> Low Feed Good Chip Control 	<b>GL</b> General Feed Good Chip Control 	<b>GL</b> General Feed Good Chip Control 
		Good Chip Control Reduce Chattering Chipping Prevention	Prevent Nip Formation Chipping Prevention Good Chip Control Reduce Chattering Chipping Prevention
		<b>GF</b> Low Cutting Force 	<b>CF</b> Low Cutting Force Feed Direction Front Cutting Edge Angle 10°/15° 
	<b>RG</b> General Feed 1st Recommendation 	<b>RN</b> General Feed 2nd Recommendation w = 2 mm 	<b>RN</b> General Feed 
			<b>GA</b> General Feed 

## Grade Selection

**New**

Cutting Process	<b>P</b> Steel	<b>M</b> Stainless Steel	<b>K</b> Cast Iron	<b>S</b> Exotic Alloy	<b>N</b> Non Ferrous Metals
Continuous, high speed ↑ ↓ Interrupted, unstable	<b>AC8025P</b> CVD	<b>AC8035P</b> (AC830P) CVD	1st Recommendation <b>AC425K</b> CVD	<b>AC5015S</b> PVD	1st Recommendation <b>H10</b>  Uncoated Carbide
	<b>AC8035P</b> (AC830P) CVD	<b>AC5015S</b> PVD	<b>AC8025P</b> CVD	<b>AC5025S</b> (AC520U) PVD	
	<b>AC5025S</b> (AC520U) PVD	1st Recommendation <b>AC5025S</b> (AC520U) PVD	<b>AC5015S</b> PVD	<b>AC5025S</b> (AC520U) PVD	
	1st Recommendation <b>AC530U/AC1030U</b> PVD	<b>AC530U</b> <b>AC1030U</b> PVD	<b>AC5025S</b> (AC520U) PVD	<b>AC530U</b> <b>AC1030U</b> PVD	

Only AC520U and AC1030U are stocked for inserts of GNDIS holders.



# Grooving Tool Holders GND Series

## For External Machining (Straight Type)

### Turning / Profiling

### Grooving / Cut-Off

**GNDS**  
Straight Type

Shank Size  
Height x Width  
20 mm x 20 mm  
25 mm x 25 mm

→ 22

Grooving Width (mm)		
1,25	1,5	2,0
3,0	4,0	5,0
6,0	7,0	8,0

Chipbreaker

MG|ML|GG|GL|GF|CG|CF|RG|RN|GA

**GNDM**  
Straight Type

Shank Size  
Height x Width  
20 mm x 20 mm  
25 mm x 25 mm  
32 mm x 25 mm  
32 mm x 32 mm

→ 24

Grooving Width (mm)		
1,25	1,5	2,0
3,0	4,0	5,0
6,0	7,0	8,0

Chipbreaker

MG|ML|GG|GL|GF|CG|CF|RG|RN|GA

**GNDM-JE**  
Straight Type

Shank Size  
Height x Width  
20 mm x 20 mm  
25 mm x 25 mm

→ 26

Grooving Width (mm)		
1,25	1,5	2,0
3,0	4,0	5,0
6,0	7,0	8,0

Chipbreaker

MG|ML|GG|GL|GF|CG|CF|RG|RN|GA

**GNDL**  
Straight Type

Shank Size  
Height x Width  
20 mm x 20 mm  
25 mm x 25 mm  
32 mm x 25 mm  
32 mm x 32 mm

→ 28

Grooving Width (mm)		
1,25	1,5	2,0
3,0	4,0	5,0
6,0	7,0	8,0

Chipbreaker

MG|ML|GG|GL|GF|CG|CF|RG|RN|GA

**GNDL-JE**  
Straight Type

Shank Size  
Height x Width  
20mm x 20mm  
25mm x 25mm

→ 30

Grooving Width (mm)		
1,25	1,5	2,0
3,0	4,0	5,0
6,0	7,0	8,0

Chipbreaker

MG|ML|GG|GL|GF|CG|CF|RG|RN|GA

### Series for External Machining (Straight Type)

Type	Shank Size		Cutting Width (mm)								Series	Max. Grooving Depth (mm)						Ref. Page	Applicable Chipbreaker															
	Height	Width	1,25	1,5	2	3	4	5	6	7		8	5	10	15	20	25		30	MG	ML	GG	GL	GF	CG	CF	RG	RN	GA					
Straight Type	20	20	1,25	1,5								GNDM	10						24															
			1,25	1,5									GNDL	16						28														
				2										GNDM	10						24													
				2										GNDM-JE	10						26													
				2										GNDL	20						28													
				2										GNDL-JE	20						30													
		25	25	3									GNDM	12						24														
				3									GNDM-JE	12						26														
				3										GNDL	20						28													
				3										GNDL-JE	20						30													
				4										GNDM	18						24													
				4										GNDM-JE	18						26													
	32	32	5	6								GNDM	25						28															
			5	6								GNDM-JE	25						30															
			5	6									GNDL	25						28														
			5	6									GNDL-JE	25						30														
			7	8									GNDM	18						24														
			7	8									GNDL	25						28														
	32	32	3									GNDM	12						24															
			3										GNDL	20						28														
			4										GNDM	18						24														
			4										GNDL	25						28														
			5	6									GNDM	18						24														
			5	6									GNDL	25						28														

Stock

\* Make to order item (32x25mm)

1st Recommendation

2nd Recommendation

# Grooving Tool Holders GND Series

## For External Machining (L Type)

### Turning / Profiling

**GNDMS**

L Type  
Shank Size  
Height x Width  
20 mm x 20 mm  
25 mm x 25 mm

→ F24

Grooving Width (mm)		
1,25	1,5	2,0
3,0	4,0	5,0
6,0	7,0	8,0

Chipbreaker  
MG|ML|GG|GL|GF|CG|CF|RG|RN|GA

### Grooving / Cut-Off

**GNDLS**

L Type  
Shank Size  
Height x Width  
20 mm x 20 mm  
25 mm x 25 mm

→ F28

Grooving Width (mm)		
1,25	1,5	2,0
3,0	4,0	5,0
6,0	7,0	8,0

Chipbreaker  
MG|ML|GG|GL|GF|CG|CF|RG|RN|GA

## Series for External Machining (L Type)

Type	Shank Size Height x Width	Cutting Width (mm)								Series	Max. Grooving Depth (mm)						Ref. Page	Applicable Chipbreaker															
		1,25	1,5	2	3	4	5	6	7		8	5	10	15	20	25		30	MG	ML	GG	GL	GF	CG	CF	RG	RN	GA					
L Type	20	20			2						GNDLS	16						F28															
						3						GNDMS	10						F24														
							3					GNDLS	16						F28														
								4				GNDMS	12						F24														
									5			GNDMS	12						F24														
												GNDLS	18						F28														
	25	25			2						GNDMS	12						F24															
						3					GNDLS	18						F28															
							3				GNDMS	14						F24															
								4				GNDLS	23						F28														
									4			GNDMS	14						F24														
										5	6	GNDLS	23						F28														
							5	6	GNDMS	14						F24																	
								5	6	GNDLS	23						F28																

■ Stock      ○ 1st Recommendation      ○ 2nd Recommendation

## Cassettes for Radial Machining

### Grooving

**GNDCM**

Cassette  
Applicable Holder  
SumiPolygon  
PSC 00 (Straight)  
PSC 90 (L Type)

→ F46

Grooving Width (mm)		
1,25	1,5	2,0
3,0	4,0	5,0
6,0	7,0	8,0

Chipbreaker  
MG|ML|GG|GL|GF|CG|CF|RG|RN|GA

## Radial Grooving Cassettes

Type	Applicable Holders	Cutting Width (mm)								Series	Max. Grooving Depth (mm)						Ref. Page	Applicable Chipbreaker												
		1,25	1,5	2	3	4	5	6	7		8	5	10	15	20	25		30	MG	ML	GG	GL	GF	CG	CF	RG	RN	GA		
Cassette	GND00			2						GNDCM	12						F46													
					3					GNDCM	12																			
	GND90					4				GNDCM	18																			
								5	6	GNDCM	18																			

■ Stock      ○ 1st Recommendation      ○ 2nd Recommendation

# Grooving Tool Holders GND Series

For Face Machining

Grooving / Turning / Profiling

**GNDF**  
Straight Type

Shank Size  
Height x Width  
20 mm x 20 mm  
25 mm x 25 mm

→ F34

Grooving Width (mm)		
1,25	1,5	2,0
3,0	4,0	5,0
6,0	7,0	8,0

Chipbreaker  
MG ML GG GL GF CG CF RGRN GA

**GNDFS**  
L Type

Shank Size  
Height x Width  
25 mm x 25 mm  
32 mm x 32 mm

→ F36

Grooving Width (mm)		
1,25	1,5	2,0
3,0	4,0	5,0
6,0	7,0	8,0

Chipbreaker  
MG ML GG GL GF CG CF RGRN GA

## Series for Face Machining

Type	Shank Size Height   Width	Cutting Width (mm)						Series	Max. Grooving Depth (mm)	Bore (mm)	Ref. Page	Applicable Chipbreaker									
		3	4	5	6	7	8					MG	ML	GG	GL	GF	CG	CF	RGRN	GA	
Straight Type	20   20	3						GNDF	12	ø35 ø45	F34	<input checked="" type="radio"/>	<input checked="" type="radio"/>	<input checked="" type="radio"/>	<input checked="" type="radio"/>	<input checked="" type="radio"/>	<input checked="" type="radio"/>	<input checked="" type="radio"/>	<input checked="" type="radio"/>	<input checked="" type="radio"/>	
		3							12	ø40 ø55		<input checked="" type="radio"/>	<input checked="" type="radio"/>	<input checked="" type="radio"/>	<input checked="" type="radio"/>	<input checked="" type="radio"/>	<input checked="" type="radio"/>	<input checked="" type="radio"/>	<input checked="" type="radio"/>	<input checked="" type="radio"/>	<input checked="" type="radio"/>
		3							18	ø50 ø70		<input checked="" type="radio"/>	<input checked="" type="radio"/>	<input checked="" type="radio"/>	<input checked="" type="radio"/>	<input checked="" type="radio"/>	<input checked="" type="radio"/>	<input checked="" type="radio"/>	<input checked="" type="radio"/>	<input checked="" type="radio"/>	<input checked="" type="radio"/>
		3							18	ø65 ø100		<input checked="" type="radio"/>	<input checked="" type="radio"/>	<input checked="" type="radio"/>	<input checked="" type="radio"/>	<input checked="" type="radio"/>	<input checked="" type="radio"/>	<input checked="" type="radio"/>	<input checked="" type="radio"/>	<input checked="" type="radio"/>	<input checked="" type="radio"/>
		3							18	ø90 ø150		<input checked="" type="radio"/>	<input checked="" type="radio"/>	<input checked="" type="radio"/>	<input checked="" type="radio"/>	<input checked="" type="radio"/>	<input checked="" type="radio"/>	<input checked="" type="radio"/>	<input checked="" type="radio"/>	<input checked="" type="radio"/>	<input checked="" type="radio"/>
		3							18	ø140 ø200		<input checked="" type="radio"/>	<input checked="" type="radio"/>	<input checked="" type="radio"/>	<input checked="" type="radio"/>	<input checked="" type="radio"/>	<input checked="" type="radio"/>	<input checked="" type="radio"/>	<input checked="" type="radio"/>	<input checked="" type="radio"/>	<input checked="" type="radio"/>
	25   25	4						GNDF	18	ø40 ø55	F34	<input checked="" type="radio"/>	<input checked="" type="radio"/>	<input checked="" type="radio"/>	<input checked="" type="radio"/>	<input checked="" type="radio"/>	<input checked="" type="radio"/>	<input checked="" type="radio"/>	<input checked="" type="radio"/>	<input checked="" type="radio"/>	<input checked="" type="radio"/>
		4							23	ø50 ø70		<input checked="" type="radio"/>	<input checked="" type="radio"/>	<input checked="" type="radio"/>	<input checked="" type="radio"/>	<input checked="" type="radio"/>	<input checked="" type="radio"/>	<input checked="" type="radio"/>	<input checked="" type="radio"/>	<input checked="" type="radio"/>	<input checked="" type="radio"/>
		4							23	ø65 ø90		<input checked="" type="radio"/>	<input checked="" type="radio"/>	<input checked="" type="radio"/>	<input checked="" type="radio"/>	<input checked="" type="radio"/>	<input checked="" type="radio"/>	<input checked="" type="radio"/>	<input checked="" type="radio"/>	<input checked="" type="radio"/>	<input checked="" type="radio"/>
		4							23	ø85 ø130		<input checked="" type="radio"/>	<input checked="" type="radio"/>	<input checked="" type="radio"/>	<input checked="" type="radio"/>	<input checked="" type="radio"/>	<input checked="" type="radio"/>	<input checked="" type="radio"/>	<input checked="" type="radio"/>	<input checked="" type="radio"/>	<input checked="" type="radio"/>
		4							23	ø125 ø200		<input checked="" type="radio"/>	<input checked="" type="radio"/>	<input checked="" type="radio"/>	<input checked="" type="radio"/>	<input checked="" type="radio"/>	<input checked="" type="radio"/>	<input checked="" type="radio"/>	<input checked="" type="radio"/>	<input checked="" type="radio"/>	<input checked="" type="radio"/>
		4							23	ø180 ø300		<input checked="" type="radio"/>	<input checked="" type="radio"/>	<input checked="" type="radio"/>	<input checked="" type="radio"/>	<input checked="" type="radio"/>	<input checked="" type="radio"/>	<input checked="" type="radio"/>	<input checked="" type="radio"/>	<input checked="" type="radio"/>	<input checked="" type="radio"/>
25   25	5						GNDF	23	ø50 ø70	F34	<input checked="" type="radio"/>	<input checked="" type="radio"/>	<input checked="" type="radio"/>	<input checked="" type="radio"/>	<input checked="" type="radio"/>	<input checked="" type="radio"/>	<input checked="" type="radio"/>	<input checked="" type="radio"/>	<input checked="" type="radio"/>	<input checked="" type="radio"/>	
	5							23	ø65 ø90		<input checked="" type="radio"/>	<input checked="" type="radio"/>	<input checked="" type="radio"/>	<input checked="" type="radio"/>	<input checked="" type="radio"/>	<input checked="" type="radio"/>	<input checked="" type="radio"/>	<input checked="" type="radio"/>	<input checked="" type="radio"/>	<input checked="" type="radio"/>	
	5							23	ø85 ø130		<input checked="" type="radio"/>	<input checked="" type="radio"/>	<input checked="" type="radio"/>	<input checked="" type="radio"/>	<input checked="" type="radio"/>	<input checked="" type="radio"/>	<input checked="" type="radio"/>	<input checked="" type="radio"/>	<input checked="" type="radio"/>	<input checked="" type="radio"/>	
	5							23	ø125 ø200		<input checked="" type="radio"/>	<input checked="" type="radio"/>	<input checked="" type="radio"/>	<input checked="" type="radio"/>	<input checked="" type="radio"/>	<input checked="" type="radio"/>	<input checked="" type="radio"/>	<input checked="" type="radio"/>	<input checked="" type="radio"/>	<input checked="" type="radio"/>	
	5							23	ø180 ø300		<input checked="" type="radio"/>	<input checked="" type="radio"/>	<input checked="" type="radio"/>	<input checked="" type="radio"/>	<input checked="" type="radio"/>	<input checked="" type="radio"/>	<input checked="" type="radio"/>	<input checked="" type="radio"/>	<input checked="" type="radio"/>	<input checked="" type="radio"/>	
	5							23	ø280 ø1.000		<input checked="" type="radio"/>	<input checked="" type="radio"/>	<input checked="" type="radio"/>	<input checked="" type="radio"/>	<input checked="" type="radio"/>	<input checked="" type="radio"/>	<input checked="" type="radio"/>	<input checked="" type="radio"/>	<input checked="" type="radio"/>	<input checked="" type="radio"/>	
L Type	20   20	6					GNDF	23	ø50 ø75	F34	<input checked="" type="radio"/>	<input checked="" type="radio"/>	<input checked="" type="radio"/>	<input checked="" type="radio"/>	<input checked="" type="radio"/>	<input checked="" type="radio"/>	<input checked="" type="radio"/>	<input checked="" type="radio"/>	<input checked="" type="radio"/>	<input checked="" type="radio"/>	
		6						23	ø70 ø110		<input checked="" type="radio"/>	<input checked="" type="radio"/>	<input checked="" type="radio"/>	<input checked="" type="radio"/>	<input checked="" type="radio"/>	<input checked="" type="radio"/>	<input checked="" type="radio"/>	<input checked="" type="radio"/>	<input checked="" type="radio"/>	<input checked="" type="radio"/>	
		6						23	ø100 ø200		<input checked="" type="radio"/>	<input checked="" type="radio"/>	<input checked="" type="radio"/>	<input checked="" type="radio"/>	<input checked="" type="radio"/>	<input checked="" type="radio"/>	<input checked="" type="radio"/>	<input checked="" type="radio"/>	<input checked="" type="radio"/>	<input checked="" type="radio"/>	
	25   25	6					GNDFS	20	ø70 ø100	F36	<input checked="" type="radio"/>	<input checked="" type="radio"/>	<input checked="" type="radio"/>	<input checked="" type="radio"/>	<input checked="" type="radio"/>	<input checked="" type="radio"/>	<input checked="" type="radio"/>	<input checked="" type="radio"/>	<input checked="" type="radio"/>	<input checked="" type="radio"/>	
		6						20	ø100 ø200		<input checked="" type="radio"/>	<input checked="" type="radio"/>	<input checked="" type="radio"/>	<input checked="" type="radio"/>	<input checked="" type="radio"/>	<input checked="" type="radio"/>	<input checked="" type="radio"/>	<input checked="" type="radio"/>	<input checked="" type="radio"/>	<input checked="" type="radio"/>	
		6						20	ø180 ø300		<input checked="" type="radio"/>	<input checked="" type="radio"/>	<input checked="" type="radio"/>	<input checked="" type="radio"/>	<input checked="" type="radio"/>	<input checked="" type="radio"/>	<input checked="" type="radio"/>	<input checked="" type="radio"/>	<input checked="" type="radio"/>	<input checked="" type="radio"/>	
25   25	8					GNDFS	20	ø70 ø100	F36	<input checked="" type="radio"/>	<input checked="" type="radio"/>	<input checked="" type="radio"/>	<input checked="" type="radio"/>	<input checked="" type="radio"/>	<input checked="" type="radio"/>	<input checked="" type="radio"/>	<input checked="" type="radio"/>	<input checked="" type="radio"/>	<input checked="" type="radio"/>	<input checked="" type="radio"/>	
	8						20	ø100 ø200		<input checked="" type="radio"/>	<input checked="" type="radio"/>	<input checked="" type="radio"/>	<input checked="" type="radio"/>	<input checked="" type="radio"/>	<input checked="" type="radio"/>	<input checked="" type="radio"/>	<input checked="" type="radio"/>	<input checked="" type="radio"/>	<input checked="" type="radio"/>	<input checked="" type="radio"/>	
	8						20	ø180 ø300		<input checked="" type="radio"/>	<input checked="" type="radio"/>	<input checked="" type="radio"/>	<input checked="" type="radio"/>	<input checked="" type="radio"/>	<input checked="" type="radio"/>	<input checked="" type="radio"/>	<input checked="" type="radio"/>	<input checked="" type="radio"/>	<input checked="" type="radio"/>	<input checked="" type="radio"/>	
	8						20	ø280 ø1.000		<input checked="" type="radio"/>	<input checked="" type="radio"/>	<input checked="" type="radio"/>	<input checked="" type="radio"/>	<input checked="" type="radio"/>	<input checked="" type="radio"/>	<input checked="" type="radio"/>	<input checked="" type="radio"/>	<input checked="" type="radio"/>	<input checked="" type="radio"/>	<input checked="" type="radio"/>	

Stock

Make to order item

1st Recommendation

2nd Recommendation





# Grooving Tool Holders GND Series

## Cassettes for Face Machining

### Face Grooving / Turning / Profiling

**GNDCF**

Cassette  
Applicable  
Holder  
SumiPolygon  
PSC 00 (Straight)  
PSC 90 (L Type)

→ F48

Grooving Width (mm)		
1,25	1,5	2,0
3,0	4,0	5,0
6,0	7,0	8,0

Chipbreaker

MG ML GG GL GF CG CF RG RN GA

### Face Grooving Cassettes

Type	Cutting Width (mm)							Series	Max. Grooving Depth (mm)					Bore (mm)					Ref. Page	Applicable Chipbreaker																	
	3	4	5	6	7	8	5		10	15	20	25	30	50	100	150	200	250		300	1.000	MG	ML	GG	GL	GF	CG	CF	RG	RN	GA						
Straight Type	3							GNDCF R/L	12					ø40 ø55					F48	<input type="checkbox"/>	<input type="checkbox"/>	<input type="checkbox"/>	<input type="checkbox"/>	<input type="checkbox"/>	<input type="checkbox"/>	<input type="checkbox"/>	<input type="checkbox"/>	<input type="checkbox"/>	<input type="checkbox"/>	<input type="checkbox"/>	<input type="checkbox"/>	<input type="checkbox"/>	<input type="checkbox"/>	<input type="checkbox"/>			
	3								15					ø50 ø75						<input type="checkbox"/>	<input type="checkbox"/>	<input type="checkbox"/>	<input type="checkbox"/>	<input type="checkbox"/>	<input type="checkbox"/>	<input type="checkbox"/>	<input type="checkbox"/>	<input type="checkbox"/>	<input type="checkbox"/>	<input type="checkbox"/>	<input type="checkbox"/>	<input type="checkbox"/>	<input type="checkbox"/>	<input type="checkbox"/>			
	3								15					ø65 ø100						<input type="checkbox"/>	<input type="checkbox"/>	<input type="checkbox"/>	<input type="checkbox"/>	<input type="checkbox"/>	<input type="checkbox"/>	<input type="checkbox"/>	<input type="checkbox"/>	<input type="checkbox"/>	<input type="checkbox"/>	<input type="checkbox"/>	<input type="checkbox"/>	<input type="checkbox"/>	<input type="checkbox"/>	<input type="checkbox"/>			
	3								18					ø90 ø150						<input type="checkbox"/>	<input type="checkbox"/>	<input type="checkbox"/>	<input type="checkbox"/>	<input type="checkbox"/>	<input type="checkbox"/>	<input type="checkbox"/>	<input type="checkbox"/>	<input type="checkbox"/>	<input type="checkbox"/>	<input type="checkbox"/>	<input type="checkbox"/>	<input type="checkbox"/>	<input type="checkbox"/>	<input type="checkbox"/>	<input type="checkbox"/>		
	3								18					ø140 ø200						<input type="checkbox"/>	<input type="checkbox"/>	<input type="checkbox"/>	<input type="checkbox"/>	<input type="checkbox"/>	<input type="checkbox"/>	<input type="checkbox"/>	<input type="checkbox"/>	<input type="checkbox"/>	<input type="checkbox"/>	<input type="checkbox"/>	<input type="checkbox"/>	<input type="checkbox"/>	<input type="checkbox"/>	<input type="checkbox"/>	<input type="checkbox"/>	<input type="checkbox"/>	
	4								18					ø40 ø55						<input type="checkbox"/>	<input type="checkbox"/>	<input type="checkbox"/>	<input type="checkbox"/>	<input type="checkbox"/>	<input type="checkbox"/>	<input type="checkbox"/>	<input type="checkbox"/>	<input type="checkbox"/>	<input type="checkbox"/>	<input type="checkbox"/>	<input type="checkbox"/>	<input type="checkbox"/>	<input type="checkbox"/>	<input type="checkbox"/>	<input type="checkbox"/>	<input type="checkbox"/>	
	4								18					ø50 ø70						<input type="checkbox"/>	<input type="checkbox"/>	<input type="checkbox"/>	<input type="checkbox"/>	<input type="checkbox"/>	<input type="checkbox"/>	<input type="checkbox"/>	<input type="checkbox"/>	<input type="checkbox"/>	<input type="checkbox"/>	<input type="checkbox"/>	<input type="checkbox"/>	<input type="checkbox"/>	<input type="checkbox"/>	<input type="checkbox"/>	<input type="checkbox"/>	<input type="checkbox"/>	<input type="checkbox"/>
	4								18					ø65 ø90						<input type="checkbox"/>	<input type="checkbox"/>	<input type="checkbox"/>	<input type="checkbox"/>	<input type="checkbox"/>	<input type="checkbox"/>	<input type="checkbox"/>	<input type="checkbox"/>	<input type="checkbox"/>	<input type="checkbox"/>	<input type="checkbox"/>	<input type="checkbox"/>	<input type="checkbox"/>	<input type="checkbox"/>	<input type="checkbox"/>	<input type="checkbox"/>	<input type="checkbox"/>	<input type="checkbox"/>
	4								18					ø85 ø130						<input type="checkbox"/>	<input type="checkbox"/>	<input type="checkbox"/>	<input type="checkbox"/>	<input type="checkbox"/>	<input type="checkbox"/>	<input type="checkbox"/>	<input type="checkbox"/>	<input type="checkbox"/>	<input type="checkbox"/>	<input type="checkbox"/>	<input type="checkbox"/>	<input type="checkbox"/>	<input type="checkbox"/>	<input type="checkbox"/>	<input type="checkbox"/>	<input type="checkbox"/>	<input type="checkbox"/>
	4								18					ø125 ø200						<input type="checkbox"/>	<input type="checkbox"/>	<input type="checkbox"/>	<input type="checkbox"/>	<input type="checkbox"/>	<input type="checkbox"/>	<input type="checkbox"/>	<input type="checkbox"/>	<input type="checkbox"/>	<input type="checkbox"/>	<input type="checkbox"/>	<input type="checkbox"/>	<input type="checkbox"/>	<input type="checkbox"/>	<input type="checkbox"/>	<input type="checkbox"/>	<input type="checkbox"/>	<input type="checkbox"/>
	4								18					ø180 ø300						<input type="checkbox"/>	<input type="checkbox"/>	<input type="checkbox"/>	<input type="checkbox"/>	<input type="checkbox"/>	<input type="checkbox"/>	<input type="checkbox"/>	<input type="checkbox"/>	<input type="checkbox"/>	<input type="checkbox"/>	<input type="checkbox"/>	<input type="checkbox"/>	<input type="checkbox"/>	<input type="checkbox"/>	<input type="checkbox"/>	<input type="checkbox"/>	<input type="checkbox"/>	<input type="checkbox"/>
	5								18					ø50 ø70						<input type="checkbox"/>	<input type="checkbox"/>	<input type="checkbox"/>	<input type="checkbox"/>	<input type="checkbox"/>	<input type="checkbox"/>	<input type="checkbox"/>	<input type="checkbox"/>	<input type="checkbox"/>	<input type="checkbox"/>	<input type="checkbox"/>	<input type="checkbox"/>	<input type="checkbox"/>	<input type="checkbox"/>	<input type="checkbox"/>	<input type="checkbox"/>	<input type="checkbox"/>	<input type="checkbox"/>
	5								18					ø65 ø90						<input type="checkbox"/>	<input type="checkbox"/>	<input type="checkbox"/>	<input type="checkbox"/>	<input type="checkbox"/>	<input type="checkbox"/>	<input type="checkbox"/>	<input type="checkbox"/>	<input type="checkbox"/>	<input type="checkbox"/>	<input type="checkbox"/>	<input type="checkbox"/>	<input type="checkbox"/>	<input type="checkbox"/>	<input type="checkbox"/>	<input type="checkbox"/>	<input type="checkbox"/>	<input type="checkbox"/>
	5								18					ø85 ø130						<input type="checkbox"/>	<input type="checkbox"/>	<input type="checkbox"/>	<input type="checkbox"/>	<input type="checkbox"/>	<input type="checkbox"/>	<input type="checkbox"/>	<input type="checkbox"/>	<input type="checkbox"/>	<input type="checkbox"/>	<input type="checkbox"/>	<input type="checkbox"/>	<input type="checkbox"/>	<input type="checkbox"/>	<input type="checkbox"/>	<input type="checkbox"/>	<input type="checkbox"/>	<input type="checkbox"/>
	5								18					ø125 ø200						<input type="checkbox"/>	<input type="checkbox"/>	<input type="checkbox"/>	<input type="checkbox"/>	<input type="checkbox"/>	<input type="checkbox"/>	<input type="checkbox"/>	<input type="checkbox"/>	<input type="checkbox"/>	<input type="checkbox"/>	<input type="checkbox"/>	<input type="checkbox"/>	<input type="checkbox"/>	<input type="checkbox"/>	<input type="checkbox"/>	<input type="checkbox"/>	<input type="checkbox"/>	<input type="checkbox"/>
	5								18					ø180 ø300						<input type="checkbox"/>	<input type="checkbox"/>	<input type="checkbox"/>	<input type="checkbox"/>	<input type="checkbox"/>	<input type="checkbox"/>	<input type="checkbox"/>	<input type="checkbox"/>	<input type="checkbox"/>	<input type="checkbox"/>	<input type="checkbox"/>	<input type="checkbox"/>	<input type="checkbox"/>	<input type="checkbox"/>	<input type="checkbox"/>	<input type="checkbox"/>	<input type="checkbox"/>	<input type="checkbox"/>
	6								18					ø50 ø75						<input type="checkbox"/>	<input type="checkbox"/>	<input type="checkbox"/>	<input type="checkbox"/>	<input type="checkbox"/>	<input type="checkbox"/>	<input type="checkbox"/>	<input type="checkbox"/>	<input type="checkbox"/>	<input type="checkbox"/>	<input type="checkbox"/>	<input type="checkbox"/>	<input type="checkbox"/>	<input type="checkbox"/>	<input type="checkbox"/>	<input type="checkbox"/>	<input type="checkbox"/>	<input type="checkbox"/>
	6								18					ø70 ø110						<input type="checkbox"/>	<input type="checkbox"/>	<input type="checkbox"/>	<input type="checkbox"/>	<input type="checkbox"/>	<input type="checkbox"/>	<input type="checkbox"/>	<input type="checkbox"/>	<input type="checkbox"/>	<input type="checkbox"/>	<input type="checkbox"/>	<input type="checkbox"/>	<input type="checkbox"/>	<input type="checkbox"/>	<input type="checkbox"/>	<input type="checkbox"/>	<input type="checkbox"/>	<input type="checkbox"/>
	6								18					ø100 ø200						<input type="checkbox"/>	<input type="checkbox"/>	<input type="checkbox"/>	<input type="checkbox"/>	<input type="checkbox"/>	<input type="checkbox"/>	<input type="checkbox"/>	<input type="checkbox"/>	<input type="checkbox"/>	<input type="checkbox"/>	<input type="checkbox"/>	<input type="checkbox"/>	<input type="checkbox"/>	<input type="checkbox"/>	<input type="checkbox"/>	<input type="checkbox"/>	<input type="checkbox"/>	<input type="checkbox"/>
	6								18					ø180 ø300						<input type="checkbox"/>	<input type="checkbox"/>	<input type="checkbox"/>	<input type="checkbox"/>	<input type="checkbox"/>	<input type="checkbox"/>	<input type="checkbox"/>	<input type="checkbox"/>	<input type="checkbox"/>	<input type="checkbox"/>	<input type="checkbox"/>	<input type="checkbox"/>	<input type="checkbox"/>	<input type="checkbox"/>	<input type="checkbox"/>	<input type="checkbox"/>	<input type="checkbox"/>	<input type="checkbox"/>
	6								18					ø280 ø1.000						<input type="checkbox"/>	<input type="checkbox"/>	<input type="checkbox"/>	<input type="checkbox"/>	<input type="checkbox"/>	<input type="checkbox"/>	<input type="checkbox"/>	<input type="checkbox"/>	<input type="checkbox"/>	<input type="checkbox"/>	<input type="checkbox"/>	<input type="checkbox"/>	<input type="checkbox"/>	<input type="checkbox"/>	<input type="checkbox"/>	<input type="checkbox"/>	<input type="checkbox"/>	<input type="checkbox"/>

Stock

Make to order item

1st Recommendation

2nd Recommendation

# Grooving Tool Holders

## GND Series

For Internal Machining ( $\geq \varnothing 14$  mm)

Grooving / Turning / Copying

**GNDIS**  
Straight Type

$\varnothing 12$  mm  
 $\varnothing 16$  mm  
 $\varnothing 20$  mm

**F40**

Grooving Width (mm)		
1,5	2,0	3,0

Chipbreaker

ML	GF
----	----

For Internal Machining ( $\geq \varnothing 32$  mm)

Grooving / Turning / Copying

**GNDI**  
Straight Type

$\varnothing 25$  mm  
 $\varnothing 32$  mm  
 $\varnothing 40$  mm

**F38**

Grooving Width (mm)		
1,25	1,5	2,0
3,0	4,0	5,0
6,0	7,0	8,0

Chipbreaker

MG	ML	GG	GL	GF	CG	CF	RG	RN	GA
----	----	----	----	----	----	----	----	----	----

### Series for Internal Machining ( $\geq \varnothing 14$ mm)

Type	Shank Size $\varnothing D_s$ (mm)	Cutting Width (mm)			Series	Max. Grooving Depth (mm)	Min. Bore (mm)	Ref. Page	Applicable Chipbreaker	
		1,5	2	3					ML	GF
Straight Type	$\varnothing 12$	1,5			GNDIS	2,6	$\varnothing 14$	F40		<input type="radio"/>
		1,5				3,6	$\varnothing 14$		<input type="radio"/>	
			2	3		2,6	$\varnothing 14$		<input type="radio"/>	
	$\varnothing 16$	1,5			GNDIS	3,6	$\varnothing 14$		<input type="radio"/>	<input type="radio"/>
		1,5				4,6	$\varnothing 16$		<input type="radio"/>	<input type="radio"/>
			2	3		3,6	$\varnothing 16$		<input type="radio"/>	<input type="radio"/>
$\varnothing 20$	1,5			GNDIS	4,6	$\varnothing 20$	<input type="radio"/>	<input type="radio"/>		
		2	3		6,6	$\varnothing 25$	<input type="radio"/>	<input type="radio"/>		
		2	3		6,6	$\varnothing 25$	<input type="radio"/>	<input type="radio"/>		

Stock

GNDIS type: use smaller GXM type inserts

1st Recommendation

### Series for Internal Machining ( $\geq \varnothing 32$ mm)

Type	Shank Size $\varnothing D_s$ (mm)	Cutting Width (mm)					Series	Max. Grooving Depth (mm)	Min. Bore (mm)	Ref. Page	Applicable Chipbreaker									
		2	3	4	5	6					MG	ML	GG	GL	GF	CG	CF	RG	RN	GA
Straight Type	$\varnothing 25$	2					GNDI	6	$\varnothing 32$	F38	<input type="radio"/>	<input type="radio"/>	<input type="radio"/>	<input type="radio"/>				<input type="radio"/>	<input type="radio"/>	
		3	4	5				6	$\varnothing 32$		<input type="radio"/>	<input type="radio"/>	<input type="radio"/>	<input type="radio"/>				<input type="radio"/>	<input type="radio"/>	
		2						6	$\varnothing 32$		<input type="radio"/>	<input type="radio"/>	<input type="radio"/>	<input type="radio"/>				<input type="radio"/>	<input type="radio"/>	
	$\varnothing 32$	3	4	5				10	$\varnothing 40$		<input type="radio"/>	<input type="radio"/>	<input type="radio"/>	<input type="radio"/>				<input type="radio"/>	<input type="radio"/>	
		3	4	5	6			11	$\varnothing 50$		<input type="radio"/>	<input type="radio"/>	<input type="radio"/>	<input type="radio"/>				<input type="radio"/>	<input type="radio"/>	
												<input type="radio"/>	<input type="radio"/>	<input type="radio"/>	<input type="radio"/>				<input type="radio"/>	<input type="radio"/>

Stock

1st Recommendation

2nd Recommendation

# Grooving Tool Holders GND Series

## Chipbreaker Selection Guide

Groov. Width (mm)	Recommended Cutting Conditions		Nose Radius (mm)	Chipbreaker
	Grooving	Turning		
1,25			0,05	MGMLGGGLGFCCFCFRGRNGA
1,5			0,05	MGMLGGGLGFCCFCFRGRNGA
2,0			0,03	MGMLGGGLGFCCFCFRGRNGA
			0,2	MGMLGGGLGFCCFCFRGRNGA
			0,4	MGMLGGGLGFCCFCFRGRNGA
			1,0	MGMLGGGLGFCCFCFRGRNGA
3,0			0,03	MGMLGGGLGFCCFCFRGRNGA
			0,2	MGMLGGGLGFCCFCFRGRNGA
			0,4	MGMLGGGLGFCCFCFRGRNGA
			1,5	MGMLGGGLGFCCFCFRGRNGA
4,0			0,2	MGMLGGGLGFCCFCFRGRNGA
			0,4	MGMLGGGLGFCCFCFRGRNGA
			0,8	MGMLGGGLGFCCFCFRGRNGA
			2,0	MGMLGGGLGFCCFCFRGRNGA
5,0			0,2	MGMLGGGLGFCCFCFRGRNGA
			0,4	MGMLGGGLGFCCFCFRGRNGA
			0,8	MGMLGGGLGFCCFCFRGRNGA
			2,5	MGMLGGGLGFCCFCFRGRNGA
6,0			0,2	MGMLGGGLGFCCFCFRGRNGA
			0,4	MGMLGGGLGFCCFCFRGRNGA
			0,8	MGMLGGGLGFCCFCFRGRNGA
			3,0	MGMLGGGLGFCCFCFRGRNGA
7,0			0,2	MGMLGGGLGFCCFCFRGRNGA
			0,4	MGMLGGGLGFCCFCFRGRNGA
			0,8	MGMLGGGLGFCCFCFRGRNGA
			3,5	MGMLGGGLGFCCFCFRGRNGA
8,0			0,2	MGMLGGGLGFCCFCFRGRNGA
			0,4	MGMLGGGLGFCCFCFRGRNGA
			0,8	MGMLGGGLGFCCFCFRGRNGA
			4,0	MGMLGGGLGFCCFCFRGRNGA

## Recommended Cutting Conditions

Work Material	P Carbon Steel, Alloy Steel					M Stainless Steel			K Cast Iron				S Exotic Alloy		N
Grade	AC8025P	AC8035P AC830P	AC5015S AC520U	AC5025S AC530U AC1030U	T2500A	AC8035P AC830P	AC5015S AC520U	AC5025S AC530U AC1030U	AC8025P	AC425K	AC5015S AC520U	AC5025S AC530U AC1030U	AC5015S AC520U	AC5025S AC530U AC1030U	H10
Cutting Speed (m/min)	80-250	80-200	80-200	50-200	50-200	70-150	70-150	50-150	80-200	80-200	60-200	50-200	20-80	20-60	150-300

# Grooving Tool Holders GND Series

## Identification Details – Holders

**GND M R 25 25 (M) - (T) 3 12 (J/JE) (- 035)**

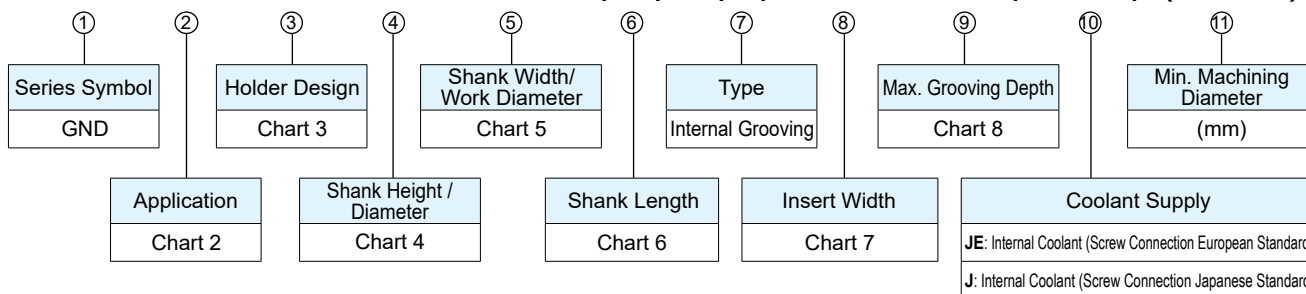

② Application		
Symbol	Application	
S	External Multi-Purpose	Grooving/Cut Off/ Turning/Profiling
M	External Multi-Purpose	Grooving/Cut Off/ Turning/Profiling
L	External Grooving	Grooving/Cut Off
MS	External L-Styled (Side Cut) Multi-Purpose	Grooving/Turning/Profiling
LS	External L-Styled (Side Cut) Deep Grooving	Grooving
N	Necking	Necking
I	Internal Grooving	Grooving/Turning/ Profiling
IS	Internal Grooving	Grooving/Turning/ Profiling
F	Face Grooving	Grooving/Turning/ Profiling
FS	L-Shaped Tools for Facing	Grooving/Turning/ Profiling
CM	Cassette for Polygon Holder	Radial Grooving
CF	Cassette for Polygon Holder	Face Grooving

③ Holder Design	
Symbol	Direction
R	Right
L	Left

④ Shank Height / Diameter		
Application	Symbol	Height (mm)
External/ Face Grooving (Shank Height)	10	10
	12	12
	16	16
	20	20
	25	25
Internal Grooving (Shank Diameter)	25	25
	32	32
	40	40

⑤ Shank Width / Work Diameter		
Application	Symbol	Width (mm)
External/ Face Grooving (Shank Width)	10	10
	12	12
	16	16
	20	20
	25	25
Internal Grooving (Shank Diameter)	32	32
	40	40
	50	50

⑥ Shank Length	
Symbol	Length (mm)
JX	120
K	125
M	150
P	170

⑧ Insert Width	
Symbol	Groov. Width (mm)
1,25	1,25
1,5	1,5
2	2,0
3	3,0
4	4,0
5	5,0
6	6,0
7	7,0
8	8,0

⑨ Max. Grooving Depth			
Symbol	Groov. Depth (mm)	Symbol	Groov. Depth (mm)
06	6,0	20	20,0
08	8,0	23	23,0
10	10,0	25	25,0
11	11,0		
12	12,0		
12,5	12,5		
14	14,0		
16	16,0		
18	18,0		

To ensure maximum rigidity, use the multi-purpose type holder to machine the maximum grooving depth.

## Identification Details – Inserts

**G C M N 30 02 (S) - G G - (05)**

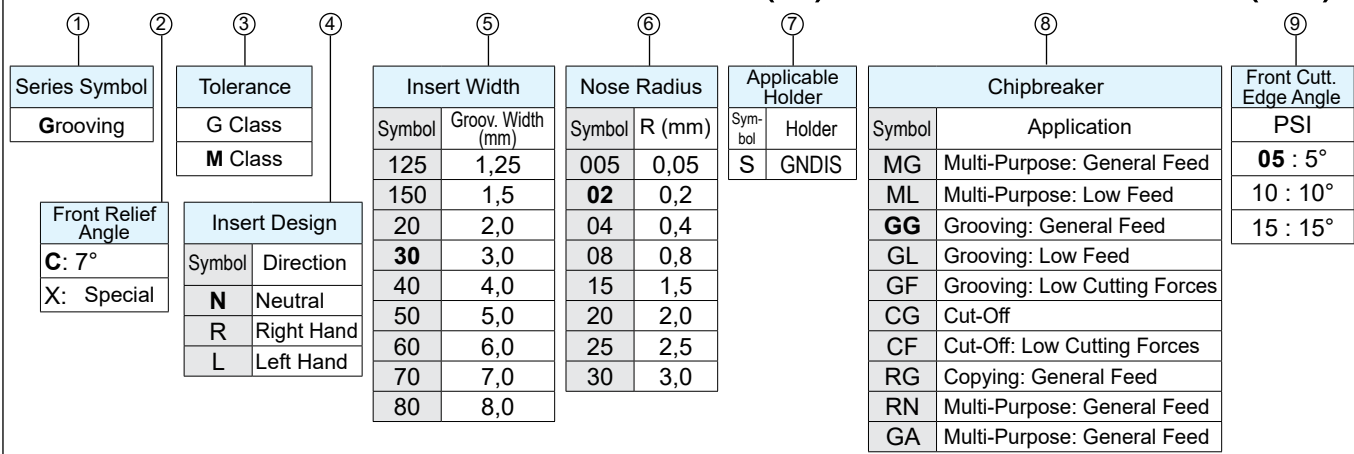

# Grooving Tool Holders GND Series

## Key Points for Face Machining

### Holder Selection

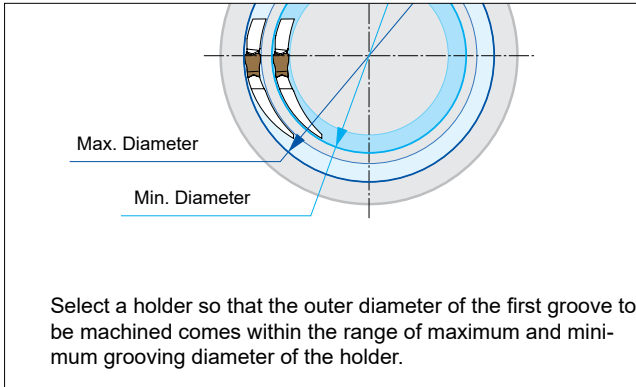

### Precautions for Groove Expansion

Recommended Chipbreaker: **MG, ML, GG, GL, GF**

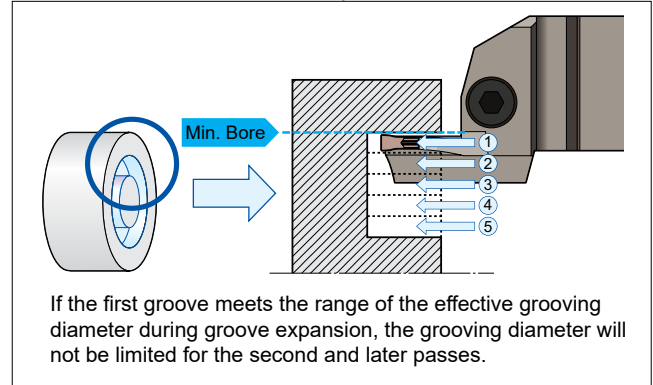

### Precautions for Turning

Recommended Chipbreaker:

**MG, ML**

Considering the rigidity of the holder, we recommend machining from the outside to the inside.

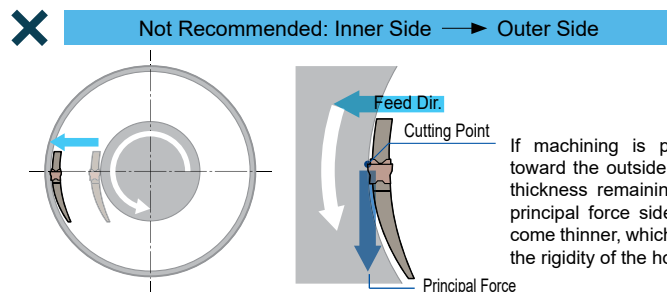
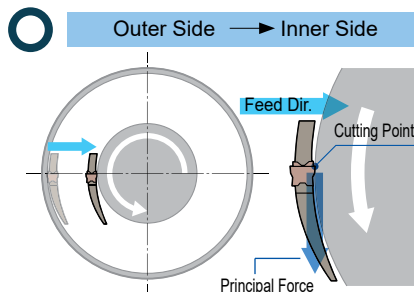

- If the first groove meets the range of the effective grooving diameter in face turning, the grooving diameter will not be limited for the second and later passes.
- Select the chipbreaker of the lower limit side of the recommended cutting conditions and straight chips before evacuation. (In face grooving, broken chips easily get stuck in grooves, which causes problems.)
- When breaking chips, step feed is required.

## Key Points for Internal Machining

### Precautions for Internal Machining

Recommended Chipbreaker:

**ML, GL**

If the prepared hole diameter is small, use an ML or GL low-feed chipbreaker, each of which reduces chip curl diameter, to ensure adequate chip evacuation.

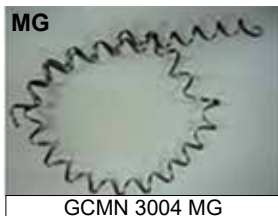

Work Material: 15CrMo5 (Ø 25 mm)  
Holder: GNDI R2532 T306  
Insert: GCM N300 □-□  
Cutting Conditions:  $v_c=100$  m/min,  $f=0,10$  mm/rev,  $a_p=3,0$  mm, wet



**!** Chip shapes differ between internal and external machining even under the same cutting conditions.

Work Material: 15CrMo5  
Holder: GNDL R2525M 320  
Insert: GCM N3002 GG  
Cutting Conditions:  $v_c=100$  m/min,  $f=0,10$  mm/rev,  $a_p=5$  mm, wet



# Grooving Tool Holders GND Series

## Precautions for Grooving Tool Holders GND Series

### Notes on how to Attach Inserts

- Remove any foreign particles or oil from the insert seat before attaching the insert.
- Ensure the seat location is clean and free of damage.
- Slide the insert level over its seat.
- Push the insert with its opposite end (the holder side) firmly against the insert stop end.
- The recommended tightening torque is 5 N.m. Tightening above the recommended torque may damage the insert or the holder which could cause injury and other accidents.

③ Attach insert on the seat flat.

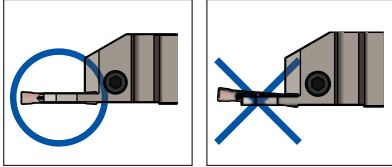

④ Push insert fully into place.

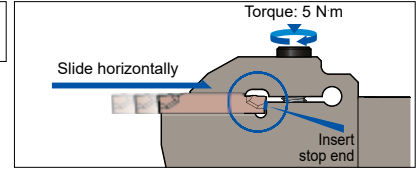

### Notes on how to Apply Holders

- Remove any foreign particles or oil from the tool post before attaching the holder.
- Ensure the seat location is clean and free of damage.
- Attach the holder so that the insert is perpendicular to the workpiece.
- Set holder with shortest possible overhang.
- When grooving or turning, adjust the center height of the cutting edge to as close  $\pm 0$  mm as possible. (Within  $\pm 0,1$  mm is recommended)
- Incorrect center height adjustment may cause chattering. (In cut-off applications, adjust the center height of the cutting edge to a value from 0,0 to +0,2 mm). A lower center height will result in larger nip at the center.

③ Attach at right angle to workpiece.

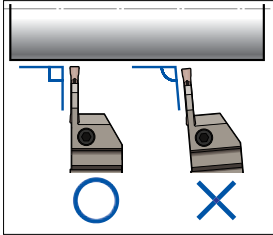

④ Set with short overhang

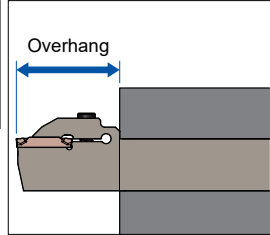

⑥ Center height adjustment in cut-off applications

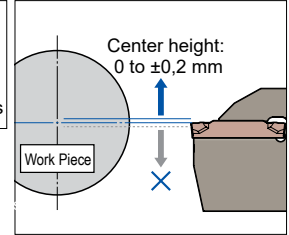

### Notes on Setting Coolant Supply Nozzle

Set the coolant supply nozzle so that coolant can be supplied from the top of the upper clamp unit.

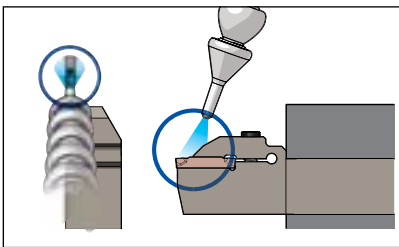

### Maximum Depth of Cut

Maximum depth of cut when pulling up with RG chipbreaker

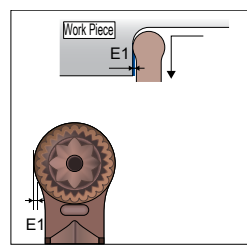

Grooving Width (mm)	Max. Depth of Cut (mm)
CW	E1
3,0	0,15
4,0	0,20
5,0	0,25
6,0	0,30
7,0	0,35
8,0	0,40

## Key Points of Internal Coolant-Type Holders for Small Lathes

The insert for internal coolant-type 12 mm and 16 mm holders for small lathes can be replaced from either the top or bottom.

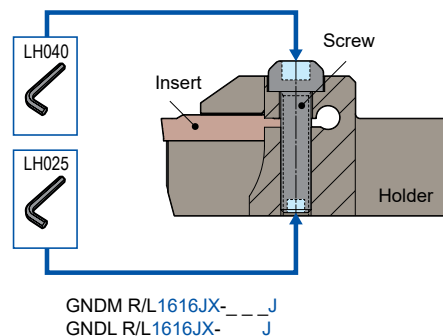
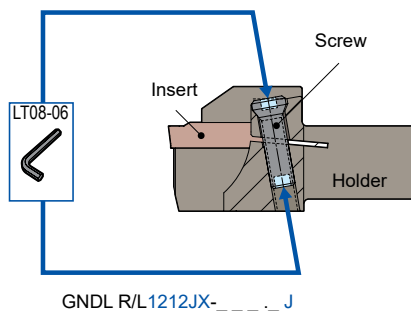

## Key Points for Connecting Hoses and Connectors

### ■ Connecting Hoses and Connectors

GNDM-JE (European standard)

Apply sealant such as commercial sealing tape to the piping connection parts.  
GNDM-JE type holders have a plug (XP02-E) mounted on the holder back end at shipping. (see fig. 1)  
When piping from the holder back end, mount a grub screw (BT0505-E) on the bottom of the holder for use. (see fig. 2)

Fig. 1 Piping from bottom

Fig. 2 Piping from back end

### ■ Connecting Hoses and Connectors (for Small Lathes)

GNDM-J (Japanese standard)

Apply sealant such as commercial sealing tape to the piping connection parts.  
Refer to the figure below for mounting the plug during piping.

Piping from side (when shipped)

Piping from rear

Hoseless coolant support products (when shipped)

\* The plug will protrude a few millimeters when mounted to the side.

\* 1 The plug will protrude a few millimeters when mounted to the side.  
\* 2 A plug is attached when shipped. Remove this plug before supplying coolant without a hose.

### Holder with Hoseless Coolant Support

Direct coolant supply from the tool post is possible without a hose

#### Connector for Hoseless Coolant Supply

Remove the plug before supplying coolant without a hose.

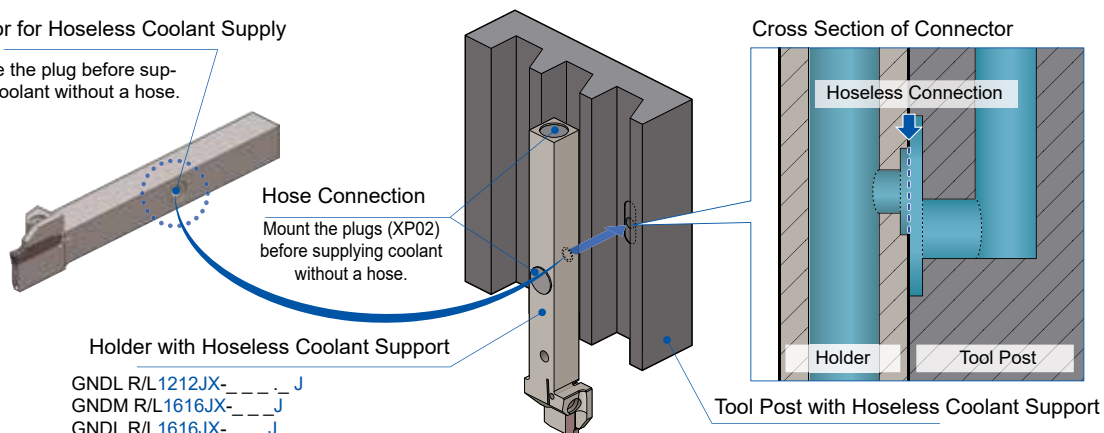

GNDL R/L1212JX-\_\_J  
GNDM R/L1616JX-\_\_J  
GNDL R/L1616JX-\_\_J

# Grooving Tool Holders GNDM / GNDL Type

Expansion

## External General-Purpose Type for Small Lathes (Grooving, Turning, Profiling)

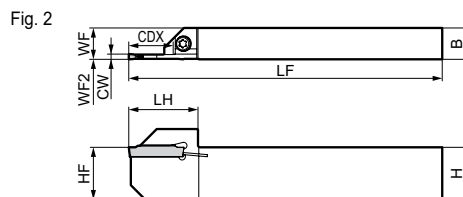
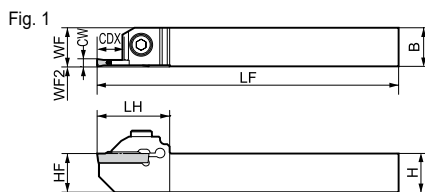
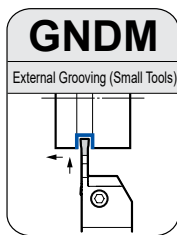

Above figures show right hand tools.

### Spare Parts

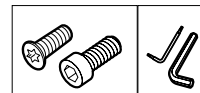

Use the multi-purpose profiling insert for turning (wide grooves).

### ■ Holders

Cat. No.	Stock		Dimensions (mm)							Grooving Width (mm)	Max. Groov. Depth (mm)	Max. Cutt-Off Dia (mm)	Fig.	Applicable Insert	Cap Screw	(N·m)	Spanner
	R	L	H	B	LF	WF	HF	LH	WF2								
GNDM R/L 1616 JX 1.2508	●	●	16	16	120	(16)	16	26	0	1,25	8,0	16	1	GCM N125005 GF	BX0515	4,0	LH040
GNDM R/L 1616 JX 1.510	●	●	16	16	120	(16)	16	26	0	1,50	10,0	20					
GNDM R/L 1616 JX 212	●	●	16	16	120	(16)	16	30	0	2,00	12,0	24					
GNDM R/L 1616 JX 312	●	●	16	16	120	(16)	16	30	0	3,00	12,0	24					
GNDM R/L 2012 JX 217 <b>New</b>	○	○	20	12	120	(12)	20	26,5	0	2,00	17,0	34	2	GCM □20○-□□	BFTX0414	3,0	LT15-10
GNDM R/L 2012 JX 317 <b>New</b>	○	○	20	12	120	(12)	20	26,5	0	3,00	17,0	34					

Select holders and inserts with the same grooving width (CW).

## External Grooving / Cut-Off for Small Lathes

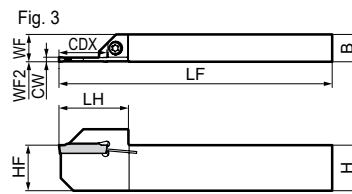
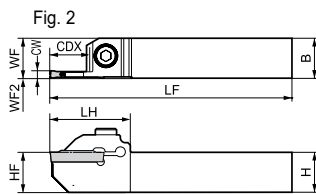
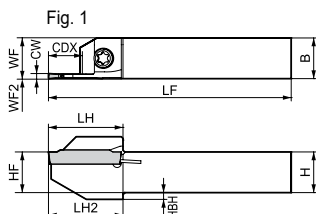
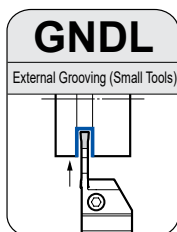

Above figures show right hand tools.

### ■ Spare Parts

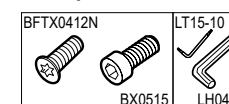

### ■ Holders

Cat. No.	Stock		Dimensions (mm)									Grooving Width (mm)	Max. Groov. Depth (mm)	Max. Cutt-Off Dia (mm)	Fig.	Applicable Insert	Cap Screw	(N·m)	Spanner
	R	L	H	B	LF	WF	HF	HBH	LH	LH2	WF2								
GNDL R/L 1010 JX 1.2510	●	●	10	10	120	(10)	10	2,0	18	18,3	0	1,25	10,0	20	1	GCM N125005 GF	BFTX0412N	3,0	LT15-10
GNDL R/L 1010 JX 1.510	●	●	10	10	120	(10)	10	2,0	18	18,3	0	1,50	10,0	20					
GNDL R/L 1010 JX 210	●	●	10	10	120	(10)	10	2,0	22	22,3	0	2,00	10,0	20					
GNDL R/L 1010 JX 310	●	●	10	10	120	(10)	10	2,0	22	22,3	0	3,00	10,0	20					
GNDL R/L 1212 JX 1.2512	●	●	12	12	120	(12)	12	2,0	19	19,3	0	1,25	12,0	24	1	GCM N125005 GF	BFTX0412N	3,0	LT15-10
GNDL R/L 1212 JX 1.512	●	●	12	12	120	(12)	12	2,0	19	19,3	0	1,50	12,0	24					
GNDL R/L 1212 JX 212.5	●	●	12	12	120	(12)	12	2,0	22	22,3	0	2,00	12,5	25					
GNDL R/L 1212 JX 312.5	●	●	12	12	120	(12)	12	2,0	22	22,3	0	3,00	12,5	25					
GNDL R/L 1616 JX 1.2512.5	○	●	16	16	120	(16)	16	-	28	-	0	1,25	12,5	25	2	GCM N125005 GF	BFTX0515	4,0	LH040
GNDL R/L 1616 JX 1.512.5	●	●	16	16	120	(16)	16	-	28	-	0	1,50	12,5	25					
GNDL R/L 1616 JX 216	●	●	16	16	120	(16)	16	-	32	-	0	2,00	16,0	32					
GNDL R/L 1616 JX 316	●	●	16	16	120	(16)	16	-	32	-	0	3,00	16,0	32					
GNDL R/L 2012 JX 221 <b>New</b>	○	○	20	12	120	(12)	20	-	30,5	-	0	2,00	21,0	42	3	GCM □20○-□□	BFTX0414	3,0	LT15-10
GNDL R/L 2012 JX 321 <b>New</b>	○	○	20	12	120	(12)	20	-	30,5	-	0	3,00	21,0	42					

Select holders and inserts with the same grooving width (CW).

## Inserts for GNDM / GNDL (Small Tools)

Coated Carbide    Cermet    Carbide

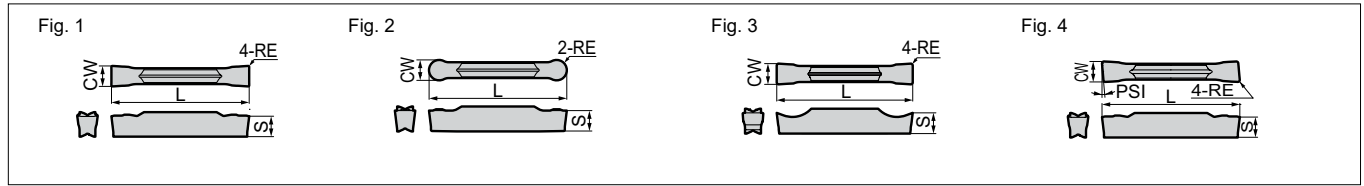

### Grooving / Traversing

Dimensions (mm)

Cat. No.	AC8025P	AC8035P	AC830P	AC425K	AC5015S	AC5025S	AC520U	AC530U	T2500A	CW		RE	L	S	Fig.
										Cutting Width	Tolerance				
GCM N3002 MG N3004 MG	●	●	●	○	●	●	○	●	—	3,0	±0.03 ±0.03	0,2 0,4	21,1 21,1	3,8 3,8	1
GCM N2002 ML N3002 ML N3004 ML	—	—	—	—	●	●	○	●	○	2,0 3,0	±0.03 ±0.03 ±0.03	0,2 0,2 0,4	21,1 21,1 21,1	3,6 3,8 3,8	1

### Grooving / Cut-Off Machining

Dimensions (mm)

Cat. No.	AC8035P	AC830P	AC5015S	AC5025S	AC520U	AC530U	T2500A	CW		RE	L	S	Fig.
								Cutting Width	Tolerance				
GCM N2002 GG N3002 GG N3004 GG	●	●	●	●	○	●	—	2,0 3,0	±0.03 ±0.03 ±0.03	0,2 0,2 0,4	21,1 21,1 21,1	3,6 3,8 3,8	1
GCM N2002 GL N2004 GL N3002 GL N3004 GL	●	●	●	●	○	●	—	2,0 3,0	±0.03 ±0.03 ±0.03 ±0.03	0,2 0,4 0,2 0,4	21,1 21,1 21,1 21,1	3,6 3,6 3,8 3,8	1
GCM N125005 GF N150005 GF	—	—	—	—	—	●	—	1,25 1,5	±0.03 ±0.03	0,05 0,05	17,4 17,4	3,2 3,7	1
GCM N2002 GF N2004 GF N3002 GF N3004 GF	—	—	●	●	○	○	—	2,0 3,0	±0.03 ±0.03 ±0.03 ±0.03	0,2 0,4 0,2 0,4	21,1 21,1 21,1 21,1	3,6 3,6 3,8 3,8	1

### External Profiling / External Radius Grooving

Dimensions (mm)

Cat. No.	AC8025P	AC8035P	AC830P	AC425K	AC5015S	AC5025S	AC520U	AC530U	T2500A	CW		RE	L	S	Fig.
										Cutting Width	Tolerance				
GCM N3015 RG	●	●	●	●	●	○	○	○	—	3,0	±0.03	1,5	21,1	3,8	2

### Profiling / Radius Grooving / Necking

Dimensions (mm)

Cat. No.	AC8025P	AC8035P	AC830P	AC425K	AC5015S	AC5025S	AC520U	AC530U	T2500A	CW		RE	L	S	Fig.
										Cutting Width	Tolerance				
GCM N2010 RN N3015 RN	—	—	—	—	●	●	○	○	—	2,0 3,0	±0.03 ±0.03	1,0 1,5	21,7 22,6	3,6 3,8	2

### Non-Ferrous Metals

Dimensions (mm)

Cat. No.	H1	CW		RE	L	S	Fig.
		Cutting Width	Tolerance				
GCG N2002 GA N3002 GA	○	2,0 3,0	±0.025 ±0.025	0,2 0,2	21,1 21,1	3,6 3,8	3

### Cut-Off Machining (Handed Edge)

Dimensions (mm)

Cat. No.	AC8035P	AC830P	AC5015S	AC5025S	AC520U	AC530U	AC1030U	PSI	CW		RE	L	S	Fig.
									Cutting Width	Tolerance				
GCM R2002 CG 05 L2002 CG 05	●	●	●	●	○	●	—	5° 5°	2,0 2,0	±0.03 ±0.03	0,2 0,2	21,1 21,1	3,6 3,6	4
GCM R3002 CG 05 L3002 CG 05	●	●	●	●	○	●	—	5° 5°	3,0 3,0	±0.03 ±0.03	0,2 0,2	21,3 21,3	3,8 3,8	
GCM R4002 CG 05 L4002 CG 05	●	●	●	●	○	●	—	5° 5°	4,0 4,0	±0.04 ±0.04	0,2 0,2	26,7 26,7	4,0 4,0	
GCM R2003 CF 10 L2003 CF 10	—	—	●	●	—	●	—	10° 10°	2,0 2,0	±0.08 ±0.08	0,03 0,03	22,4 22,4	3,6 3,6	4
GCM R3003 CF 10 L3003 CF 10	—	—	●	●	—	●	—	10° 10°	3,0 3,0	±0.08 ±0.08	0,03 0,03	22,4 22,4	3,8 3,8	
GCM R2003 CF 15 L2003 CF 15	—	—	●	●	—	●	—	15° 15°	2,0 2,0	±0.08 ±0.08	0,03 0,03	22,4 22,4	3,6 3,6	
GCM R3003 CF 15 L3003 CF 15	—	—	●	●	—	●	—	15° 15°	3,0 3,0	±0.08 ±0.08	0,03 0,03	22,4 22,4	3,8 3,8	

GCM R: Right hand      GCM L: Left hand  
Combine the insert with a holder such that the width of cut (CW) matches.

# Grooving Tool Holders GNDM-J/GNDL-J Type



## Holder with Internal Coolant

### External Multi-Purpose Type for Small Lathes (Grooving, Turning, Profiling)

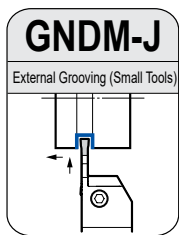

Use the multi-purpose profiling insert for turning (wide grooves).

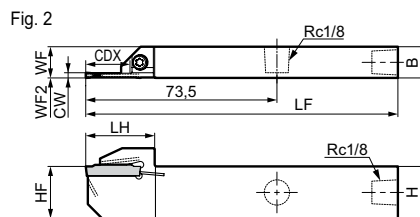
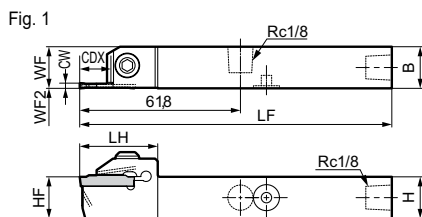

Above figures show right hand tools.

#### Spare Parts

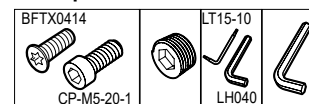

#### ■ Holders

Cat. No.	Stock		Dimensions (mm)									Grooving Width (mm)	Max. Groov. Depth (mm)	Max. Cutt-Off Dia (mm)	Fig.	Applicable Insert	Screw / Cap Screw	Plug	Wrench for Upper Surface	Wrench for Lower Surface
	R	L	H	B	LF	WF	HF	LH	WF2	CW	CDX									
GNDM R/L 1616 JX 212 J	○	○	16	16	120 (16)	16	30,0	0	2,0	12,0	24	1	GC □ 2000-□□	CP-M5-20-1	5,0	XP02	LH040	LH025		
GNDM R/L 1616 JX 312 J	○	○	16	16	120 (16)	16	30,0	0	3,0	12,0	24	1	GC □ 3000-□□	CP-M5-20-1	5,0	XP02	LH040	LH025		
GNDM R/L 2012 JX 217 J	○	○	20	12	120 (12)	20	26,5	0	2,0	17,0	34	2	GC □ 2000-□□	BFTX0414	3,0	XP02	LT15-10			
GNDM R/L 2012 JX 317 J	○	○	20	12	120 (12)	20	26,5	0	3,0	17,0	34	2	GC □ 3000-□□	BFTX0414	3,0	XP02	LT15-10			

Select holders and inserts with the same grooving width (CW).

### External Grooving / Cut-Off for Small Lathes

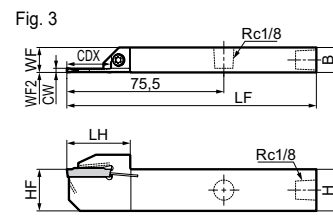
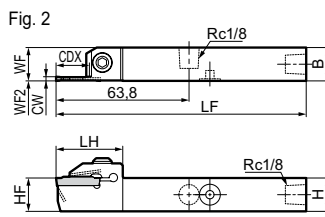
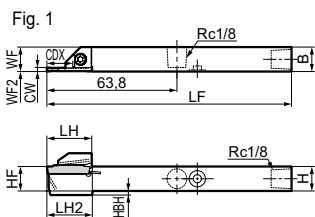
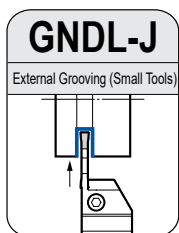

Above figures show right hand tools.

#### ■ Spare Parts

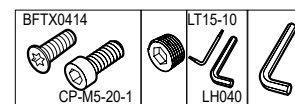

#### ■ Holders

Cat. No.	Stock		Dimensions (mm)									Grooving Width (mm)	Max. Groov. Depth (mm)	Max. Cutt-Off Dia (mm)	Fig.	Applicable Insert	Screw / Cap Screw	Plug	Wrench for Upper Surface	Wrench for Lower Surface
	R	L	H	B	LF	WF	HF	HBH	LH	LH2	WF2									
GNDL R/L 1212 JX 212.5 J	○	○	12	12	120 (12)	12	2,0	22,0	22,3	0	2,0	12,5	25	1	GCM □ 2000-□□	BFTX0415T8R	1,5	XP02	LT08-06	
GNDL R/L 1212 JX 312.5 J	○	○	12	12	120 (12)	12	2,0	22,0	22,3	0	3,0	12,5	25	1	GC □ 3000-□□	BFTX0415T8R	1,5	XP02	LT08-06	
GNDL R/L 1616 JX 216 J	○	○	16	16	120 (16)	16	-	32,0	-	0	2,0	16,0	32	2	GC □ 2000-□□	CP-M5-20-1	5,0	XP02	LH040	LH025
GNDL R/L 1616 JX 316 J	○	○	16	16	120 (16)	16	-	32,0	-	0	3,0	16,0	32	2	GC □ 3000-□□	CP-M5-20-1	5,0	XP02	LH040	LH025
GNDL R/L 2012 JX 221 J	○	○	20	12	120 (12)	20	-	30,5	-	0	2,0	21,0	42	3	GCM □ 2000-□□	BFTX0414	3,0	XP02	LT15-10	
GNDL R/L 2012 JX 321 J	○	○	20	12	120 (12)	20	-	30,5	-	0	3,0	21,0	42	3	GCM □ 3000-□□	BFTX0414	3,0	XP02	LT15-10	

Select holders and inserts with the same grooving width (CW).

#### ■ Parts (Hoses and Connectors)

See page 21

# Grooving Tool Holders GNDM-J / GNDL-J Type

## ■ Inserts for GNDM-J / GNDL-J (Small Tools)

Coated Carbide    Cermet    Carbide

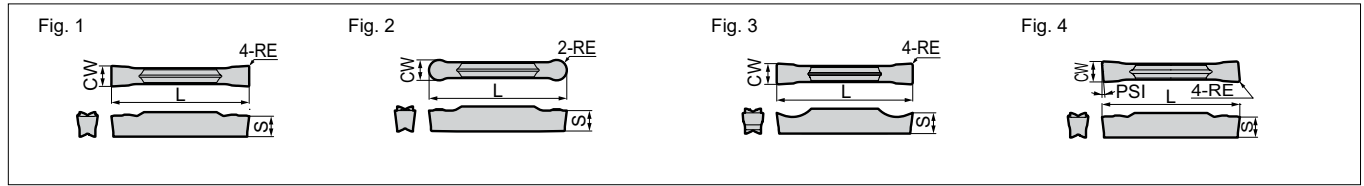

### ● Grooving / Traversing

Dimensions (mm)

Cat. No.	AC8025P	AC8035P	AC830P	AC425K	AC5015S	AC5025S	AC520U	AC530U	T2500A	CW		RE	L	S	Fig.
										Cutting Width	Tolerance				
GCM N3002 MG N3004 MG	●	●	●	○	●	●	○	●	—	3,0	±0.03	0,2	21,1	3,8	1
											±0.03	0,4	21,1	3,8	
GCM N2002 ML N3002 ML N3004 ML	—	—	—	—	●	●	○	●	—	2,0	±0.03	0,2	21,1	3,6	1
	●	●	●	○	●	●	○	○	—	3,0	±0.03	0,2	21,1	3,8	
	●	●	○	●	●	●	○	○	—		±0.03	0,4	21,1	3,8	

### ● Grooving / Cut-Off Machining

Dimensions (mm)

Cat. No.	AC8035P	AC830P	AC5015S	AC5025S	AC520U	AC530U	T2500A	CW		RE	L	S	Fig.
								Cutting Width	Tolerance				
GCM N2002 GG N3002 GG N3004 GG	●	●	●	●	○	●	—	2,0	±0.03	0,2	21,1	3,6	1
	●	●	●	●	○	●	—	3,0	±0.03	0,2	21,1	3,8	
	●	●	●	●	○	●	—		±0.03	0,4	21,1	3,8	
GCM N2002 GL N2004 GL N3002 GL N3004 GL	●	●	●	●	○	●	—	2,0	±0.03	0,2	21,1	3,6	1
	●	●	●	●	○	●	—	±0.03	0,4	21,1	3,6		
	●	●	●	●	○	●	—	3,0	±0.03	0,2	21,1	3,8	
	●	●	●	●	○	●	—		±0.03	0,4	21,1	3,8	
GCM N125005 GF N150005 GF	—	—	—	—	—	●	—	1,25	±0.03	0,05	17,4	3,2	1
	—	—	—	—	—	●	—	1,5	±0.03	0,05	17,4	3,7	
GCM N2002 GF N2004 GF N3002 GF N3004 GF	—	—	●	●	—	○	○	2,0	±0.03	0,2	21,1	3,6	1
	—	—	●	●	—	○	○	±0.03	0,4	21,1	3,6		
	—	—	●	●	—	○	○	3,0	±0.03	0,2	21,1	3,8	
	—	—	●	●	—	○	○		±0.03	0,4	21,1	3,8	

### ● External Profiling / External Radius Grooving

Dimensions (mm)

Cat. No.	AC8025P	AC8035P	AC830P	AC425K	AC5015S	AC5025S	AC520U	AC530U	T2500A	CW		RE	L	S	Fig.
										Cutting Width	Tolerance				
GCM N3015 RG	●	●	●	○	●	●	○	●	—	3,0	±0.03	1,5	21,1	3,8	2

### ● Profiling / Radius Grooving / Necking

Dimensions (mm)

Cat. No.	AC8025P	AC8035P	AC830P	AC425K	AC5015S	AC5025S	AC520U	AC530U	T2500A	CW		RE	L	S	Fig.
										Cutting Width	Tolerance				
GCM N2010 RN N3015 RN	—	—	—	—	●	●	○	○	—	2,0	±0.03	1,0	21,7	3,6	2
	●	●	●	○	●	●	○	○	—	3,0	±0.03	1,5	22,6	3,8	

### ● Non-Ferrous Metals

Dimensions (mm)

Cat. No.	H1	CW		RE	L	S	Fig.
		Cutting Width	Tolerance				
GCG N2002 GA N3002 GA	○	2,0	±0.025	0,2	21,1	3,6	3
	○	3,0	±0.025	0,2	21,1	3,8	

## ■ Parts (Hoses and Connectors)

### ● Parts Hoses

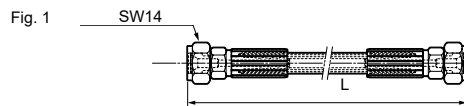

Cat. No.	Stock	L (mm)	Screw Standard	Screw Standard	Fig.
J-HOSE-G1/8-G1/8-200-E	●	200	G1/8	G1/8	1
J-HOSE-G1/8-G1/8-300-E	●	300	G1/8	G1/8	1

Hoses are sold separately.

### ● Parts (Connector) on Holder Side

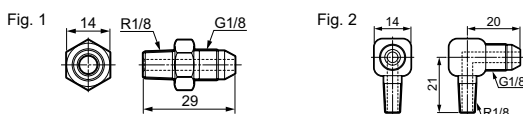

Cat. No.	Stock	Screw Standard	Screw Standard	Fig.
J-G1/8-R1/8-00	○	G1/8	R1/8	1
J-G1/8-R1/8-90	○	G1/8	R1/8	2

Connectors are sold separately.

### ● Parts (Connector) on Machine Side

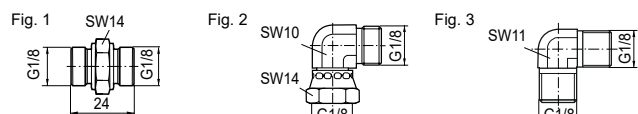

Cat. No.	Stock	Screw Standard	Screw Standard	Fig.
J-G1/8-G1/8-00-E	●	G1/8	G1/8	1
J-G1/8-G1/8F-90-E	●	G1/8	G1/8	2
J-G1/8-G1/8-90-E	●	G1/8	G1/8	3

Connectors are sold separately.



# Grooving Tool Holders GNDS Type

## External Multi-Purpose Shallow Grooves Type (Grooving, Turning, Profiling)

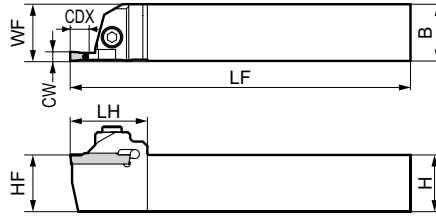
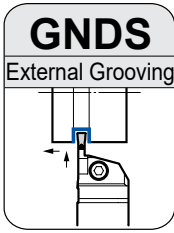

Use the multi-purpose profiling insert for turning (wide grooves).

Above figures show right hand tools.

### ■ Spare Parts

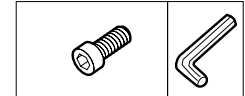

### ■ Holders

Cat. No.	Stock		Dimensions (mm)						Grooving Width (mm)	Max. Groov. Depth (mm)	Applicable Insert	Cap Screw	N·m	Spanner
	R	L	H	B	LF	WF	HF	LH						
GNDS R/L 2020 K 206	●	●	20	20	125	20	20	30	2,0	6	GCM □2000-□□	BX0520	5,0	LH040
GNDS R/L 2020 K 306	●	●	20	20	125	20	20	30	3,0	6	GCM □3000-□□			
GNDS R/L 2020 K 410	●	●	20	20	125	20	20	34	4,0	10	GCM □4000-□□			
GNDS R/L 2020 K 510	●	●	20	20	125	20	20	34	5,0	10	GCM N5000-□□			
GNDS R/L 2020 K 610	●	●	20	20	125	20	20	34	6,0	10	GCM N6000-□□			
GNDS R/L 2525 M 206	●	●	25	25	150	25	25	30	2,0	6	GCM □2000-□□			
GNDS R/L 2525 M 306	●	●	25	25	150	25	25	30	3,0	6	GCM □3000-□□			
GNDS R/L 2525 M 410	●	●	25	25	150	25	25	34	4,0	10	GCM □4000-□□			
GNDS R/L 2525 M 510	●	●	25	25	150	25	25	34	5,0	10	GCM N5000-□□			
GNDS R/L 2525 M 610	●	●	25	25	150	25	25	34	6,0	10	GCM N6000-□□			

Select holders and inserts with the same grooving width (CW).

## Inserts for GNDS

Coated Carbide    Cermet    Carbide

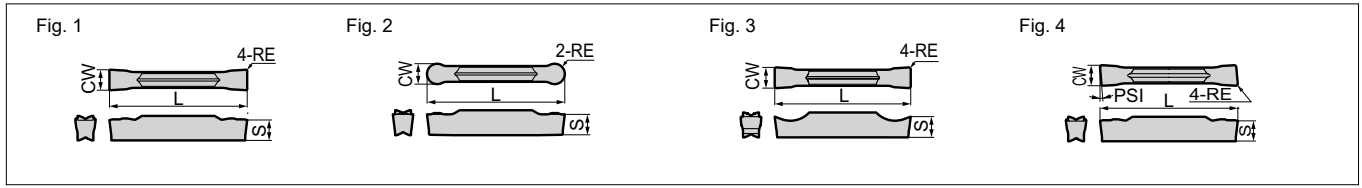

### Grooving / Traversing

Dimensions (mm)

Cat. No.	CW								Fig.						
	AC8025P	AC8035P	AC830P	AC425K	AC5015S	AC5025S	AC520U	AC530U		T2500A					
GCM N3002 MG	●	●	○	○	●	●	○	○	—	3,0	±0.03	0,2	21,1	3,8	1
N3004 MG	●	●	○	○	●	●	○	○	—	3,0	±0.03	0,4	21,1	3,8	
N4002 MG	●	●	○	○	●	●	○	○	—	4,0	±0.03	0,2	26,4	4,0	
N4004 MG	●	●	○	○	●	●	○	○	—	4,0	±0.03	0,4	26,4	4,0	
N4008 MG	●	●	○	○	●	●	○	○	—	4,0	±0.03	0,8	26,4	4,0	
N5004 MG	●	●	○	○	●	●	○	○	—	5,0	±0.03	0,4	26,4	4,1	
N5008 MG	●	●	○	○	●	●	○	○	—	5,0	±0.03	0,8	26,4	4,1	
N6004 MG	●	●	○	○	●	●	○	○	—	6,0	±0.03	0,4	26,4	4,5	
N6008 MG	●	●	○	○	●	●	○	○	—	6,0	±0.03	0,8	26,4	4,5	
GCM N2002 ML	—	—	—	—	●	●	○	○	—	2,0	±0.03	0,2	21,1	3,6	1
N3002 ML	●	●	○	○	●	●	○	○	—	3,0	±0.03	0,2	21,1	3,8	
N3004 ML	●	●	○	○	●	●	○	○	—	3,0	±0.03	0,4	21,1	3,8	
N4002 ML	●	●	○	○	●	●	○	○	—	4,0	±0.03	0,2	26,4	4,0	
N4004 ML	●	●	○	○	●	●	○	○	—	4,0	±0.03	0,4	26,4	4,0	
N4008 ML	●	●	○	○	●	●	○	○	—	4,0	±0.03	0,8	26,4	4,0	
N5004 ML	●	●	○	○	●	●	○	○	—	5,0	±0.03	0,4	26,4	4,1	
N5008 ML	●	●	○	○	●	●	○	○	—	5,0	±0.03	0,8	26,4	4,1	
N6004 ML	●	●	○	○	●	●	○	○	—	6,0	±0.03	0,4	26,4	4,5	
N6008 ML	●	●	○	○	●	●	○	○	—	6,0	±0.03	0,8	26,4	4,5	

### Grooving / Cut-Off Machining

Dimensions (mm)

Cat. No.	CW								Fig.					
	AC8035P	AC830P	AC5015S	AC5025S	AC520U	AC530U	T2500A	RE		L	S			
GCM N2002 GG	●	●	●	●	○	○	—	—	2,0	±0.03	0,2	21,1	3,6	1
N3002 GG	●	●	●	●	○	○	—	—	3,0	±0.03	0,2	21,1	3,8	
N3004 GG	●	●	●	●	○	○	—	—	3,0	±0.03	0,4	21,1	3,8	
N4002 GG	●	●	●	●	○	○	—	—	4,0	±0.03	0,2	26,4	4,0	
N4004 GG	●	●	●	●	○	○	—	—	4,0	±0.03	0,4	26,4	4,0	
N5002 GG	●	●	●	●	○	○	—	—	5,0	±0.03	0,2	26,4	4,1	
N5004 GG	●	●	●	●	○	○	—	—	5,0	±0.03	0,4	26,4	4,1	
N6002 GG	●	●	●	●	○	○	—	—	6,0	±0.03	0,2	26,4	4,5	
N6004 GG	●	●	●	●	○	○	—	—	6,0	±0.03	0,4	26,4	4,5	
GCM N2002 GL	●	●	●	●	○	○	—	—	2,0	±0.03	0,2	21,1	3,6	1
N2004 GL	●	●	●	●	○	○	—	—	2,0	±0.03	0,4	21,1	3,6	
N3002 GL	●	●	●	●	○	○	—	—	3,0	±0.03	0,2	21,1	3,8	
N3004 GL	●	●	●	●	○	○	—	—	3,0	±0.03	0,4	21,1	3,8	
N4002 GL	●	●	●	●	○	○	—	—	4,0	±0.03	0,2	26,4	4,0	
N4004 GL	●	●	●	●	○	○	—	—	4,0	±0.03	0,4	26,4	4,0	
N5002 GL	●	●	●	●	○	○	—	—	5,0	±0.03	0,2	26,4	4,1	
N5004 GL	●	●	●	●	○	○	—	—	5,0	±0.03	0,4	26,4	4,1	
N6002 GL	●	●	●	●	○	○	—	—	6,0	±0.03	0,2	26,4	4,5	
N6004 GL	●	●	●	●	○	○	—	—	6,0	±0.03	0,4	26,4	4,5	
GCM N2002 GF	—	—	●	●	○	○	—	—	2,0	±0.03	0,2	21,1	3,6	1
N2004 GF	—	—	●	●	○	○	—	—	2,0	±0.03	0,4	21,1	3,6	
N3002 GF	●	●	●	●	○	○	—	—	3,0	±0.03	0,2	21,1	3,8	
N3004 GF	●	●	●	●	○	○	—	—	3,0	±0.03	0,4	21,1	3,8	
N4002 GF	●	●	●	●	○	○	—	—	4,0	±0.03	0,2	26,4	4,0	
N4004 GF	●	●	●	●	○	○	—	—	4,0	±0.03	0,4	26,4	4,0	
N5002 GF	●	●	●	●	○	○	—	—	5,0	±0.03	0,2	26,4	4,1	
N5004 GF	●	●	●	●	○	○	—	—	5,0	±0.03	0,4	26,4	4,1	
N6002 GF	●	●	●	●	○	○	—	—	6,0	±0.03	0,2	26,4	4,5	
N6004 GF	●	●	●	●	○	○	—	—	6,0	±0.03	0,4	26,4	4,5	

### External Profiling / External Radius Grooving

Dimensions (mm)

Cat. No.	CW								Fig.						
	AC8025P	AC8035P	AC830P	AC425K	AC5015S	AC5025S	AC520U	AC530U		T2500A					
GCM N3015 RG	●	●	○	○	●	●	○	○	—	3,0	±0.03	1,5	21,1	3,8	2
N4020 RG	●	●	○	○	●	●	○	○	—	4,0	±0.03	2,0	26,4	4,0	
N5025 RG	●	●	○	○	●	●	○	○	—	5,0	±0.03	2,5	27,2	4,1	
N6030 RG	●	●	○	○	●	●	○	○	—	6,0	±0.03	3,0	27,5	4,5	

### Cut-Off Machining (Handed Edge)

Dimensions (mm)

Cat. No.	CW								PSI	Fig.					
	AC8035P	AC830P	AC5015S	AC5025S	AC520U	AC530U	AC1030U	RE			L	S			
GCM R2002 CG 05	●	●	●	●	○	○	—	—	5°	2,0	±0.03	0,2	21,1	3,6	4
L2002 CG 05	●	●	●	●	○	○	—	—	5°	2,0	±0.03	0,2	21,1	3,6	
GCM R3002 CG 05	●	●	●	●	○	○	—	—	5°	3,0	±0.03	0,2	21,3	3,8	
L3002 CG 05	●	●	●	●	○	○	—	—	5°	3,0	±0.03	0,2	21,3	3,8	
GCM R4002 CG 05	●	●	●	●	○	○	—	—	5°	4,0	±0.04	0,2	26,7	4,0	
L4002 CG 05	●	●	●	●	○	○	—	—	5°	4,0	±0.04	0,2	26,7	4,0	
GCM R2003 CF 10	—	—	●	●	—	—	●	—	10°	2,0	±0.08	0,03	22,4	3,6	
L2003 CF 10	—	—	●	●	—	—	●	—	10°	2,0	±0.08	0,03	22,4	3,6	
GCM R3003 CF 10	—	—	●	●	—	—	●	—	10°	3,0	±0.08	0,03	22,4	3,8	
L3003 CF 10	—	—	●	●	—	—	●	—	10°	3,0	±0.08	0,03	22,4	3,8	
GCM R2003 CF 15	—	—	●	●	—	—	●	—	15°	2,0	±0.08	0,03	22,4	3,6	4
L2003 CF 15	—	—	●	●	—	—	●	—	15°	2,0	±0.08	0,03	22,4	3,6	
GCM R3003 CF 15	—	—	●	●	—	—	●	—	15°	3,0	±0.08	0,03	22,4	3,8	
L3003 CF 15	—	—	●	●	—	—	●	—	15°	3,0	±0.08	0,03	22,4	3,8	

GCM R: Right hand    GCM L: Left hand  
Combine the insert with a holder such that the width of cut (CW) matches.

### Profiling / Radius Grooving / Necking

Dimensions (mm)

Cat. No.	CW								Fig.						
	AC8025P	AC8035P	AC830P	AC425K	AC5015S	AC5025S	AC520U	AC530U		T2500A					
GCM N2010 RN	—	—	—	—	●	●	○	○	—	2,0	±0.03	1,0	21,7	3,6	2
N3015 RN	●	●	○	○	●	●	○	○	—	3,0	±0.03	1,5	22,6	3,8	
N4020 RN	●	●	○	○	●	●	○	○	—	4,0	±0.03	2,0	28,2	4,0	
N5025 RN	●	●	○	○	●	●	○	○	—	5,0	±0.03	2,5	28,3	4,1	
N6030 RN	●	●	○	○	●	●	○	○	—	6,0	±0.03	3,0	28,3	4,5	

### Non-Ferrous Metals

Dimensions (mm)

Cat. No.	H1	CW					Fig.
		Cutting Width	Tolerance	RE	L	S	
GCG N2002 GA	○	2,0	±0.025	0,2	21,1	3,6	3
N3002 GA	○	3,0	±0.025	0,2	21,1	3,8	
N4004 GA	○	4,0	±0.025	0,4	26,4	4,0	
N5004 GA	○	5,0	±0.025	0,4	26,4	4,1	
N6004 GA	○	6,0	±0.025	0,4	26,4	4,5	

# Grooving Tool Holders GNDM / GNDMS Type

## External Multi-Purpose Type (Grooving, Turning, Profiling)

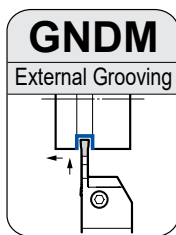

Use for multi-purpose or profiling insert for turning (wide grooves).

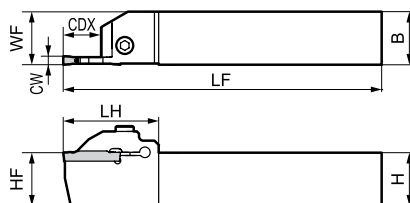

Above figures show right hand tools.

### Spare Parts

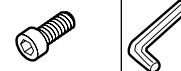

### ■ Holders

Cat. No.	Stock		Dimensions (mm)						Grooving Width (mm)	Max. Groov. Depth (mm)	Max. Cut-Off Dia (mm)	Applicable Insert	Cap Screw	N·m	Spanner
	R	L	H	B	LF	WF	HF	LH							
GNDM R/L 2020 K 1.2510	●	●	20	20	125	20	20	34,0	1,25	10	20	GCM N125005 GF	BX0520	5,0	LH040
GNDM R/L 2020 K 1.510	●	●	20	20	125	20	20	34,0	1,50	10	20	GCM N150005 GF			
GNDM R/L 2020 K 210	●	●	20	20	125	20	20	33,6	2,00	10	20	GCM □2000-□□			
GNDM R/L 2020 K 312	●	●	20	20	125	20	20	36,6	3,00	12	24	GCM □3000-□□			
GNDM R/L 2020 K 418	●	●	20	20	125	20	20	45,0	4,00	18	36	GCM □4000-□□			
GNDM R/L 2020 K 518	●	●	20	20	125	20	20	45,0	5,00	18	36	GCM N5000-□□			
GNDM R/L 2020 K 618	●	●	20	20	125	20	20	45,0	6,00	18	36	GCM N6000-□□			
GNDM R/L 2525 M 1.2510	●	●	25	25	150	25	25	36,0	1,25	10	20	GCM N125005 GF			
GNDM R/L 2525 M 1.510	●	●	25	25	150	25	25	36,0	1,50	10	20	GCM N150005 GF			
GNDM R/L 2525 M 210	●	●	25	25	150	25	25	33,6	2,00	10	20	GCM N2000-□□			
GNDM R/L 2525 M 312	●	●	25	25	150	25	25	36,6	3,00	12	24	GCM □3000-□□			
GNDM R/L 2525 M 418	●	●	25	25	150	25	25	45,0	4,00	18	36	GCM □4000-□□			
GNDM R/L 2525 M 518	●	●	25	25	150	25	25	45,0	5,00	18	36	GCM N5000-□□			
GNDM R/L 2525 M 618	●	●	25	25	150	25	25	45,0	6,00	18	36	GCM N6000-□□			
GNDM R/L 3225 P 312			32	25	170	25	32	36,6	3,00	12	24	GCM □3000-□□	BX0620	6,0	LH050
GNDM R/L 3225 P 418			32	25	170	25	32	45,0	4,00	18	36	GCM □4000-□□			
GNDM R/L 3225 P 518			32	25	170	25	32	45,0	5,00	18	36	GCM N5000-□□			
GNDM R/L 3225 P 618			32	25	170	25	32	45,0	6,00	18	36	GCM N6000-□□			
GNDM R/L 3225 P 718			32	25	170	25	32	50,0	7,00	18	36	GCM N7000-□□			
GNDM R/L 3225 P 818			32	25	170	25	32	50,0	8,00	18	36	GCM N8000-□□			
GNDM R/L 3232 P 312	●	●	32	32	170	32	32	36,6	3,00	12	24	GCM □3000-□□	BX0620	6,0	LH050
GNDM R/L 3232 P 418	●	●	32	32	170	32	32	45,0	4,00	18	36	GCM □4000-□□			
GNDM R/L 3232 P 518	●	●	32	32	170	32	32	45,0	5,00	18	36	GCM N5000-□□			
GNDM R/L 3232 P 618	●	●	32	32	170	32	32	45,0	6,00	18	36	GCM N6000-□□			
GNDM R/L 3232 P 718	●	●	32	32	170	32	32	50,0	7,00	18	36	GCM N7000-□□			
GNDM R/L 3232 P 818	●	●	32	32	170	32	32	50,0	8,00	18	36	GCM N8000-□□			

Select holders and inserts with the same grooving width (CW).

## External L-Styled (Side Cut) Multi-Purpose Type (Grooving, Turning, Profiling)

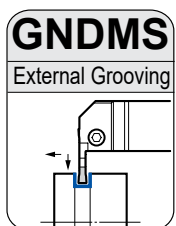

Use for multi-purpose or profiling insert for turning (wide grooves).

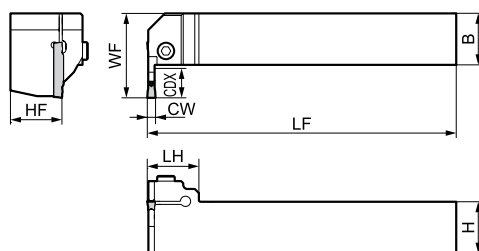

Above figures show right hand tools.

### Spare Parts

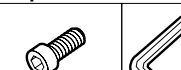

### ■ Holders

Cat. No.	Stock		Dimensions (mm)						Grooving Width (mm)	Max. Groov. Depth (mm)	Applicable Insert	Cap Screw	N·m	Spanner
	R	L	H	B	LF	WF	HF	LH						
GNDMS R/L 2020 K 310	●	○	20	20	125	32	20	25	3,0	10	GCM □3000-□□	BX0520	5,0	LH040
GNDMS R/L 2020 K 412	●	●	20	20	125	34	20	25	4,0	12	GCM □4000-□□			
GNDMS R/L 2020 K 512	●	○	20	20	125	34	20	25	5,0	12	GCM N5000-□□			
GNDMS R/L 2525 M 312	●	●	25	25	150	39	25	25	3,0	12	GCM □3000-□□			
GNDMS R/L 2525 M 414	●	●	25	25	150	41	25	25	4,0	14	GCM □4000-□□			
GNDMS R/L 2525 M 514	●	●	25	25	150	41	25	25	5,0	14	GCM N5000-□□			
GNDMS R/L 2525 M 614	●	●	25	25	150	41	25	25	6,0	14	GCM N6000-□□			

Select holders and inserts with the same grooving width (CW).

## Inserts for GNDM / GNDMS

Coated Carbide    Cermet    Carbide

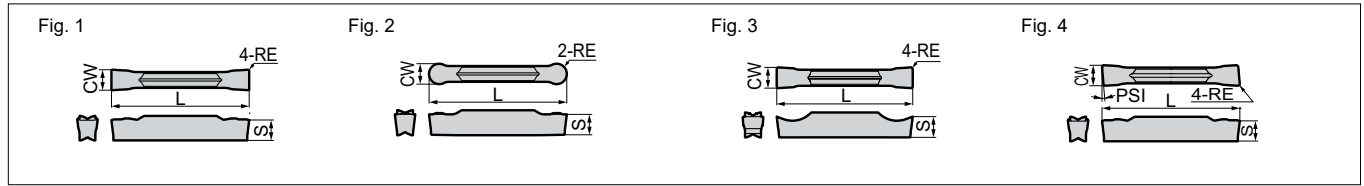

### Grooving / Traversing

Dimensions (mm)

Cat. No.	Material								CW		RE	L	S	Fig.		
	AC8025P	AC8035P	AC830P	AC425K	AC5015S	AC5025S	AC520U	AC530U	AC530U	T2500A					Cutting Width	Tolerance
GCM N3002 MG	●	●	○	○	●	●	●	●	●	—	3,0	±0.03	0,2	21,1	3,8	1
N3004 MG	●	●	○	○	●	●	●	●	●	—	±0.03	0,4	21,1	3,8		
N4002 MG	●	●	○	○	●	●	●	●	●	—	4,0	±0.03	0,2	26,4	4,0	
N4004 MG	●	●	○	○	●	●	●	●	●	—	±0.03	0,4	26,4	4,0		
N4008 MG	●	●	○	○	●	●	●	●	●	—	±0.03	0,8	26,4	4,0		
N5004 MG	●	●	○	○	●	●	●	●	●	—	5,0	±0.03	0,4	26,4	4,1	
N5008 MG	●	●	○	○	●	●	●	●	●	—	±0.03	0,8	26,4	4,1		
N6004 MG	●	●	○	○	●	●	●	●	●	—	6,0	±0.03	0,4	26,4	4,5	
N6008 MG	●	●	○	○	●	●	●	●	●	—	±0.03	0,8	26,4	4,5		
N7004 MG	●	●	○	○	●	●	●	●	●	—	7,0	±0.04	0,4	28,8	5,5	
N7008 MG	●	●	○	○	●	●	●	●	●	—	±0.04	0,8	28,8	5,5		
N8004 MG	●	●	○	○	●	●	●	●	●	—	±0.04	0,4	28,8	6,0		
N8008 MG	●	●	○	○	●	●	●	●	●	—	±0.04	0,8	28,8	6,0		
GCM N2002 ML	—	—	—	—	○	○	○	○	○	—	2,0	±0.03	0,2	21,1	3,6	1
N3002 ML	●	●	○	○	●	●	●	●	●	—	±0.03	0,2	21,1	3,8		
N3004 ML	●	●	○	○	●	●	●	●	●	—	±0.03	0,4	21,1	3,8		
N4002 ML	●	●	○	○	●	●	●	●	●	—	±0.03	0,2	26,4	4,0		
N4004 ML	●	●	○	○	●	●	●	●	●	—	±0.03	0,4	26,4	4,0		
N4008 ML	●	●	○	○	●	●	●	●	●	—	±0.03	0,8	26,4	4,0		
N5004 ML	●	●	○	○	●	●	●	●	●	—	5,0	±0.03	0,4	26,4	4,1	
N5008 ML	●	●	○	○	●	●	●	●	●	—	±0.03	0,8	26,4	4,1		
N6004 ML	●	●	○	○	●	●	●	●	●	—	±0.03	0,4	26,4	4,5		
N6008 ML	●	●	○	○	●	●	●	●	●	—	±0.03	0,8	26,4	4,5		
N7004 ML	●	●	○	○	●	●	●	●	●	—	7,0	±0.04	0,4	28,8	5,5	
N7008 ML	●	●	○	○	●	●	●	●	●	—	±0.04	0,8	28,8	5,5		
N8004 ML	●	●	○	○	●	●	●	●	●	—	±0.04	0,4	28,8	6,0		
N8008 ML	●	●	○	○	●	●	●	●	●	—	±0.04	0,8	28,8	6,0		

### Grooving / Cut-Off Machining

Dimensions (mm)

Cat. No.	Material								CW		RE	L	S	Fig.	
	AC8035P	AC830P	AC5015S	AC5025S	AC520U	AC530U	AC530U	T2500A	Cutting Width	Tolerance					
GCM N2002 GG	●	●	●	●	○	○	○	○	—	2,0	±0.03	0,2	21,1	3,6	1
N3002 GG	●	●	●	●	○	○	○	○	—	±0.03	0,2	21,1	3,8		
N3004 GG	●	●	●	●	○	○	○	○	—	3,0	±0.03	0,4	21,1	3,8	
N4002 GG	●	●	●	●	○	○	○	○	—	±0.03	0,2	26,4	4,0		
N4004 GG	●	●	●	●	○	○	○	○	—	4,0	±0.03	0,4	26,4	4,0	
N5002 GG	●	●	●	●	○	○	○	○	—	±0.03	0,2	26,4	4,1		
N5004 GG	●	●	●	●	○	○	○	○	—	5,0	±0.03	0,4	26,4	4,1	
N6002 GG	●	●	●	●	○	○	○	○	—	±0.03	0,2	26,4	4,5		
N6004 GG	●	●	●	●	○	○	○	○	—	6,0	±0.03	0,4	26,4	4,5	
N7004 GG	●	○	●	●	○	○	○	○	—	7,0	±0.04	0,4	28,8	5,5	
N8004 GG	●	●	●	●	○	○	○	○	—	8,0	±0.04	0,4	28,8	6,0	
GCM N2002 GL	●	●	●	●	○	○	○	○	—	2,0	±0.03	0,2	21,1	3,6	1
N2004 GL	●	●	●	●	○	○	○	○	—	±0.03	0,4	21,1	3,6		
N3002 GL	●	●	●	●	○	○	○	○	—	3,0	±0.03	0,2	21,1	3,8	
N3004 GL	●	●	●	●	○	○	○	○	—	±0.03	0,4	21,1	3,8		
N4002 GL	●	●	●	●	○	○	○	○	—	±0.03	0,2	26,4	4,0		
N4004 GL	●	●	●	●	○	○	○	○	—	4,0	±0.03	0,4	26,4	4,0	
N5002 GL	●	●	●	●	○	○	○	○	—	±0.03	0,2	26,4	4,1		
N5004 GL	●	●	●	●	○	○	○	○	—	5,0	±0.03	0,4	26,4	4,1	
N6002 GL	●	●	●	●	○	○	○	○	—	±0.03	0,2	26,4	4,5		
N6004 GL	●	●	●	●	○	○	○	○	—	6,0	±0.03	0,4	26,4	4,5	
N7004 GL	●	○	●	●	○	○	○	○	—	7,0	±0.04	0,4	28,8	5,5	
N8004 GL	●	○	●	●	○	○	○	○	—	8,0	±0.04	0,4	28,8	6,0	
GCM N125005 GF	—	—	—	—	—	—	—	—	—	1,25	±0.03	0,05	17,4	3,2	1
N150005 GF	—	—	—	—	—	—	—	—	—	1,5	±0.03	0,05	17,4	3,7	
GCM N2002 GF	—	—	—	—	○	○	○	○	—	2,0	±0.03	0,2	21,1	3,6	1
N2004 GF	—	—	—	—	○	○	○	○	—	±0.03	0,4	21,1	3,6		
N3002 GF	●	●	●	●	○	○	○	○	—	3,0	±0.03	0,2	21,1	3,8	
N3004 GF	●	●	●	●	○	○	○	○	—	±0.03	0,4	21,1	3,8		
N4002 GF	●	●	●	●	○	○	○	○	—	4,0	±0.03	0,2	26,4	4,0	
N4004 GF	●	●	●	●	○	○	○	○	—	±0.03	0,4	26,4	4,0		
N5002 GF	●	●	●	●	○	○	○	○	—	5,0	±0.03	0,2	26,4	4,1	
N5004 GF	●	●	●	●	○	○	○	○	—	±0.03	0,4	26,4	4,1		
N6002 GF	●	●	●	●	○	○	○	○	—	6,0	±0.03	0,2	26,4	4,5	
N6004 GF	●	●	●	●	○	○	○	○	—	±0.03	0,4	26,4	4,5		
N7002 GF	●	●	●	●	○	○	○	○	—	7,0	±0.04	0,2	28,8	5,5	
N7004 GF	●	●	●	●	○	○	○	○	—	±0.04	0,4	28,8	5,5		
N8002 GF	●	●	●	●	○	○	○	○	—	8,0	±0.04	0,2	28,8	6,0	
N8004 GF	●	●	●	●	○	○	○	○	—	±0.04	0,4	28,8	6,0		

### External Profiling / External Radius Grooving

Dimensions (mm)

Cat. No.	Material								CW		RE	L	S	Fig.		
	AC8025P	AC8035P	AC830P	AC425K	AC5015S	AC5025S	AC520U	AC530U	AC530U	T2500A					Cutting Width	Tolerance
GCM N3015 RG	●	●	○	○	●	●	●	●	●	—	3,0	±0.03	1,5	21,1	3,8	2
N4020 RG	●	●	○	○	●	●	●	●	●	—	4,0	±0.03	2,0	26,4	4,0	
N5025 RG	●	●	○	○	●	●	●	●	●	—	5,0	±0.03	2,5	27,2	4,1	
N6030 RG	●	●	○	○	●	●	●	●	●	—	6,0	±0.03	3,0	27,5	4,5	
N7035 RG	●	●	○	○	●	●	●	●	●	—	7,0	±0.04	3,5	29,1	5,5	
N8040 RG	●	●	○	○	●	●	●	●	●	—	8,0	±0.04	4,0	29,3	6,0	

### Cut-Off Machining (Handed Edge)

Dimensions (mm)

Cat. No.	Material								PSI	CW		RE	L	S	Fig.
	AC8035P	AC830P	AC5015S	AC5025S	AC520U	AC530U	AC1030U	Cutting Width		Tolerance					
GCM R2002 CG 05	●	●	●	●	○	○	○	—	5°	2,0	±0.03	0,2	21,1	3,6	4
L2002 CG 05	●	●	●	●	○	○	○	—	5°	2,0	±0.03	0,2	21,1	3,6	
GCM R3002 CG 05	●	●	●	●	○	○	○	—	5°	3,0	±0.03	0,2	21,3	3,8	
L3002 CG 05	●	●	●	●	○	○	○	—	5°	3,0	±0.03	0,2	21,3	3,8	
GCM R4002 CG 05	●	●	●	●	○	○	○	—	5°	4,0	±0.04	0,2	26,7	4,0	4
L4002 CG 05	●	●	●	●	○	○	○	—	5°	4,0	±0.04	0,2	26,7	4,0	
GCM R2003 CF 10	—	—	—	—	—	—	—	—	10°	2,0	±0.08	0,03	22,4	3,6	4
L2003 CF 10	—	—	—	—	—	—	—	—	10°	2,0	±0.08	0,03	22,4	3,6	
GCM R3003 CF 10	—	—	—	—	—	—	—	—	10°	3,0	±0.08	0,03	22,4	3,8	
L3003 CF 10	—	—	—	—	—	—	—	—	10°	3,0	±0.08	0,03	22,4	3,8	
GCM R2003 CF 15	—	—	—	—	—	—	—	—	15°	2,0	±0.08	0,03	22,4	3,6	
L2003 CF 15	—	—	—	—	—	—	—	—	15°	2,0	±0.08	0,03	22,4	3,6	
GCM R3003 CF 15	—	—	—	—	—	—	—	—	15°	3,0	±0.08	0,03	22,4	3,8	
L3003 CF 15	—	—	—	—	—	—	—	—	15°	3,0	±0.08	0,03	22,4	3,8	

GCM R: Right hand    GCM L: Left hand  
Combine the insert with a holder such that the width of cut (CW) matches.

### Profiling / Radius Grooving / Necking

Dimensions (mm)

# Grooving Tool Holders GNDM-JE Type

## Holder with Internal Coolant

### External Multi-Purpose Type (Grooving, Turning, Profiling)

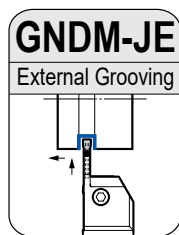

Internal Coolant



Use for multi-purpose or profiling insert for turning (wide grooves).

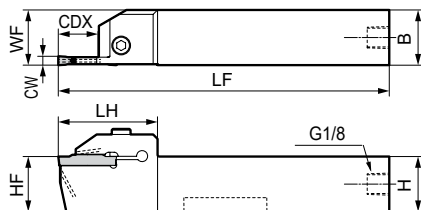

Above figures show right hand tools.

### Spare Parts

Cap Screw	Plug and Sealing	Grub Screw*	Spanner	
BX0520	6,0	XP02-E	BT0505-E	LH040

### Holders

Cat. No.	Stock		Dimensions (mm)						Grooving Width (mm)	Max. Groov. Depth (mm)	Max. Cutt-Off Dia (mm)	Applicable Insert	Cap Screw	Plug and Sealing	Grub Screw*	Spanner	
	R	L	H	B	LF	WF	HF	LH									CW
GNDM R/L 2020 X 210 JE	●	●	20	20	100	20	20	33,6	2,00	10	20	GC □ 2000-□□	BX0520	6,0	XP02-E	BT0505-E	LH040
GNDM R/L 2020 X 312 JE	●	●	20	20	100	20	20	36,6	3,00	12	24	GC □ 3000-□□					
GNDM R/L 2020 X 418 JE	●	●	20	20	110	20	20	45,0	4,00	18	36	GC □ 4000-□□					
GNDM R/L 2020 X 518 JE	●	●	20	20	110	20	20	45,0	5,00	18	36	GC □ N5000-□□					
GNDM R/L 2020 X 618 JE	●	●	20	20	110	20	20	45,0	6,00	18	36	GC □ N6000-□□					
GNDM R/L 2525 X 210 JE	●	●	25	25	100	25	25	33,6	2,00	10	20	GC □ 2000-□□					
GNDM R/L 2525 X 312 JE	●	●	25	25	100	25	25	36,6	3,00	12	24	GC □ 3000-□□					
GNDM R/L 2525 X 418 JE	●	●	25	25	110	25	25	45,0	4,00	18	36	GC □ 4000-□□					
GNDM R/L 2525 X 518 JE	●	●	25	25	110	25	25	45,0	5,00	18	36	GC □ N5000-□□					
GNDM R/L 2525 X 618 JE	●	●	25	25	110	25	25	45,0	6,00	18	36	GC □ N6000-□□					

Select holders and inserts with the same grooving width (CW).

\*Grub screws are sold separately (M5x5)

### Parts (Hose)

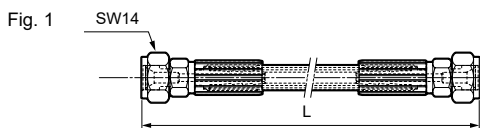

Cat. No.	Stock	L (mm)	Srew Standard	Srew Standard	Fig.
J-HOSE-G1/8-G1/8-200-E	●	200	G1/8	G1/8	1
J-HOSE-G1/8-G1/8-300-E	●	300	G1/8	G1/8	1

Hoses are sold separately.

### Parts (Connector)

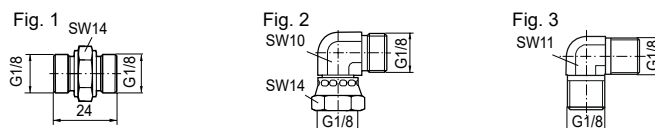

Cat. No.	Stock	Srew Standard	Srew Standard	Fig.
J-G1/8-G1/8-00-E	●	G1/8	G1/8	1
J-G1/8-G1/8F-90-E	●	G1/8	G1/8	2
J-G1/8-G1/8-90-E	●	G1/8	G1/8	3

Connectors are sold separately.



## Inserts for GNDM-JE

Coated Carbide    Cermet    Carbide

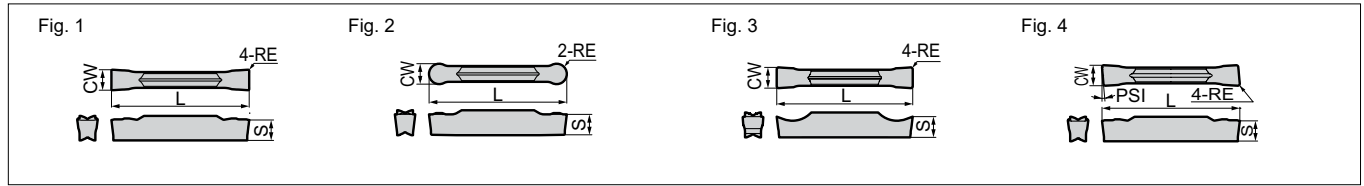

### Grooving / Traversing

Dimensions (mm)

Cat. No.	CW								Fig.						
	AC8025P	AC8035P	AC830P	AC425K	AC5015S	AC5025S	AC520U	AC530U		T2500A	Cutting Width	Tolerance	RE	L	S
GCM N3002 MG	●	●	●	○	●	●	●	●	—	3,0	±0.03	0,2	21,1	3,8	1
N3004 MG	●	●	●	○	●	●	●	●	—	3,0	±0.03	0,4	21,1	3,8	
N4002 MG	●	●	●	○	●	●	●	●	—	4,0	±0.03	0,2	26,4	4,0	
N4004 MG	●	●	●	○	●	●	●	●	—	4,0	±0.03	0,4	26,4	4,0	
N4008 MG	●	●	●	○	●	●	●	●	—	4,0	±0.03	0,8	26,4	4,0	
N5004 MG	●	●	●	○	●	●	●	●	—	5,0	±0.03	0,4	26,4	4,1	
N5008 MG	●	●	●	○	●	●	●	●	—	5,0	±0.03	0,8	26,4	4,1	
N6004 MG	●	●	●	○	●	●	●	●	—	6,0	±0.03	0,4	26,4	4,5	
N6008 MG	●	●	●	○	●	●	●	●	—	6,0	±0.03	0,8	26,4	4,5	
GCM N2002 ML	—	—	—	—	●	●	●	●	○	2,0	±0.03	0,2	21,1	3,6	1
N3002 ML	—	—	—	—	●	●	●	●	○	3,0	±0.03	0,2	21,1	3,8	
N3004 ML	—	—	—	—	●	●	●	●	○	3,0	±0.03	0,4	21,1	3,8	
N4002 ML	—	—	—	—	●	●	●	●	○	4,0	±0.03	0,2	26,4	4,0	
N4004 ML	—	—	—	—	●	●	●	●	○	4,0	±0.03	0,4	26,4	4,0	
N4008 ML	—	—	—	—	●	●	●	●	○	4,0	±0.03	0,8	26,4	4,0	
N5004 ML	—	—	—	—	●	●	●	●	○	5,0	±0.03	0,4	26,4	4,1	
N5008 ML	—	—	—	—	●	●	●	●	○	5,0	±0.03	0,8	26,4	4,1	
N6004 ML	—	—	—	—	●	●	●	●	○	6,0	±0.03	0,4	26,4	4,5	
N6008 ML	—	—	—	—	●	●	●	●	○	6,0	±0.03	0,8	26,4	4,5	

### Grooving / Cut-Off Machining

Dimensions (mm)

Cat. No.	CW								Fig.				
	AC8035P	AC830P	AC5015S	AC5025S	AC520U	AC530U	T2500A	Cutting Width		Tolerance	RE	L	S
GCM N2002 GG	●	●	●	●	●	●	—	2,0	±0.03	0,2	21,1	3,6	1
N3002 GG	●	●	●	●	●	●	—	3,0	±0.03	0,2	21,1	3,8	
N3004 GG	●	●	●	●	○	●	—	3,0	±0.03	0,4	21,1	3,8	
N4002 GG	●	●	●	●	○	●	—	4,0	±0.03	0,2	26,4	4,0	
N4004 GG	●	●	●	●	○	●	—	4,0	±0.03	0,4	26,4	4,0	
N5002 GG	●	●	●	●	○	●	—	5,0	±0.03	0,2	26,4	4,1	
N5004 GG	●	●	●	●	○	●	—	5,0	±0.03	0,4	26,4	4,1	
N6002 GG	●	●	●	●	○	●	—	6,0	±0.03	0,2	26,4	4,5	
N6004 GG	●	●	●	●	○	●	—	6,0	±0.03	0,4	26,4	4,5	
GCM N2002 GL	●	●	●	●	○	●	—	2,0	±0.03	0,2	21,1	3,6	1
N2004 GL	●	●	●	●	○	●	—	2,0	±0.03	0,4	21,1	3,6	
N3002 GL	●	●	●	●	○	●	—	3,0	±0.03	0,2	21,1	3,8	
N3004 GL	●	●	●	●	○	●	—	3,0	±0.03	0,4	21,1	3,8	
N4002 GL	●	●	●	●	○	●	—	4,0	±0.03	0,2	26,4	4,0	
N4004 GL	●	●	●	●	○	●	—	4,0	±0.03	0,4	26,4	4,0	
N5002 GL	●	●	●	●	○	●	—	5,0	±0.03	0,2	26,4	4,1	
N5004 GL	●	●	●	●	○	●	—	5,0	±0.03	0,4	26,4	4,1	
N6002 GL	●	●	●	●	○	●	—	6,0	±0.03	0,2	26,4	4,5	
N6004 GL	●	●	●	●	○	●	—	6,0	±0.03	0,4	26,4	4,5	
GCM N2002 GF	—	—	●	●	●	○	—	2,0	±0.03	0,2	21,1	3,6	1
N2004 GF	—	—	●	●	●	○	—	2,0	±0.03	0,4	21,1	3,6	
N3002 GF	●	●	●	●	●	○	—	3,0	±0.03	0,2	21,1	3,8	
N3004 GF	●	●	●	●	●	○	—	3,0	±0.03	0,4	21,1	3,8	
N4002 GF	●	●	●	●	●	○	—	4,0	±0.03	0,2	26,4	4,0	
N4004 GF	●	●	●	●	●	○	—	4,0	±0.03	0,4	26,4	4,0	
N5002 GF	●	●	●	●	●	○	—	5,0	±0.03	0,2	26,4	4,1	
N5004 GF	●	●	●	●	●	○	—	5,0	±0.03	0,4	26,4	4,1	
N6002 GF	●	●	●	●	●	○	—	6,0	±0.03	0,2	26,4	4,5	
N6004 GF	●	●	●	●	●	○	—	6,0	±0.03	0,4	26,4	4,5	

### External Profiling / External Radius Grooving

Dimensions (mm)

Cat. No.	CW								Fig.						
	AC8025P	AC8035P	AC830P	AC425K	AC5015S	AC5025S	AC520U	AC530U		T2500A	Cutting Width	Tolerance	RE	L	S
GCM N3015 RG	●	●	●	●	●	●	○	●	○	3,0	±0.03	1,5	21,1	3,8	2
N4020 RG	●	●	●	●	●	●	○	●	○	4,0	±0.03	2,0	26,4	4,0	
N5025 RG	●	●	●	●	●	●	○	●	○	5,0	±0.03	2,5	27,2	4,1	
N6030 RG	●	●	●	●	●	●	○	●	○	6,0	±0.03	3,0	27,5	4,5	

### Cut-Off Machining (Handed Edge)

Dimensions (mm)

Cat. No.	CW								PSI	Fig.				
	AC8035P	AC830P	AC5015S	AC5025S	AC520U	AC530U	AC1030U	Cutting Width			Tolerance	RE	L	S
GCM R2002 CG 05	●	●	●	●	○	●	—	5°	2,0	±0.03	0,2	21,1	3,6	4
L2002 CG 05	●	●	●	●	○	●	—	5°	2,0	±0.03	0,2	21,1	3,6	
GCM R3002 CG 05	●	●	●	●	○	●	—	5°	3,0	±0.03	0,2	21,3	3,8	
L3002 CG 05	●	●	●	●	○	●	—	5°	3,0	±0.03	0,2	21,3	3,8	
GCM R4002 CG 05	●	●	●	●	○	●	—	5°	4,0	±0.04	0,2	26,7	4,0	
L4002 CG 05	●	●	●	●	○	●	—	5°	4,0	±0.04	0,2	26,7	4,0	
GCM R2003 CF 10	—	—	●	●	—	●	—	10°	2,0	±0.08	0,03	22,4	3,6	
L2003 CF 10	—	—	●	●	—	●	—	10°	2,0	±0.08	0,03	22,4	3,6	
GCM R3003 CF 10	—	—	●	●	—	●	—	10°	3,0	±0.08	0,03	22,4	3,8	
L3003 CF 10	—	—	●	●	—	●	—	10°	3,0	±0.08	0,03	22,4	3,8	
GCM R2003 CF 15	—	—	●	●	—	●	—	15°	2,0	±0.08	0,03	22,4	3,6	4
L2003 CF 15	—	—	●	●	—	●	—	15°	2,0	±0.08	0,03	22,4	3,6	
GCM R3003 CF 15	—	—	●	●	—	●	—	15°	3,0	±0.08	0,03	22,4	3,8	
L3003 CF 15	—	—	●	●	—	●	—	15°	3,0	±0.08	0,03	22,4	3,8	

GCM R: Right hand    GCM L: Left hand  
Combine the insert with a holder such that the width of cut (CW) matches.

### Profiling / Radius Grooving / Necking

Dimensions (mm)

Cat. No.	CW								Fig.						
	AC8025P	AC8035P	AC830P	AC425K	AC5015S	AC5025S	AC520U	AC530U		T2500A	Cutting Width	Tolerance	RE	L	S
GCM N2010 RN	—	—	—	—	●	●	○	●	—	2,0	±0.03	1,0	21,7	3,6	2
N3015 RN	●	●	●	○	●	●	○	●	—	3,0	±0.03	1,5	22,6	3,8	
N4020 RN	●	●	●	○	●	●	○	●	—	4,0	±0.03	2,0	28,2	4,0	
N5025 RN	●	●	●	○	●	●	○	●	—	5,0	±0.03	2,5	28,3	4,1	
N6030 RN	●	●	●	○	●	●	○	●	—	6,0	±0.03	3,0	28,3	4,5	

### Non-Ferrous Metals

Dimensions (mm)

Cat. No.	H1	CW					Fig.
		Cutting Width	Tolerance	RE	L	S	
GCG N2002 GA	○	2,0	±0.025	0,2	21,1	3,6	3
N3002 GA	○	3,0	±0.025	0,2	21,1	3,8	
N4004 GA	○	4,0	±0.025	0,4	26,4	4,0	
N5004 GA	○	5,0	±0.025	0,4	26,4	4,1	
N6004 GA	○	6,0	±0.025	0,4	26,4	4,5	



# Grooving Tool Holders GNDL / GNDLS Type

## External Deep Grooving and Cut-Off

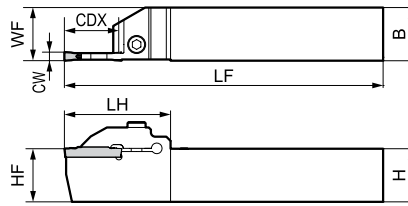
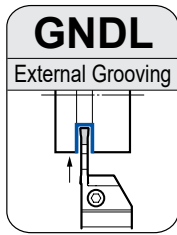

Above figures show right hand tools.

### Spare Parts



### ■ Holders

Cat. No.	Stock		Dimensions (mm)						Grooving Width (mm)	Max. Groov. Depth (mm)	Max. Cut-Off Dia (mm)	Applicable Insert	Cap Screw	N·m	Spanner
	R	L	H	B	LF	WF	HF	LH							
GNDL R/L 2020 K 1.2516	●	●	20	20	125	20	20	38,0	1,25	16	32	GCM N125005 GF	BX0520	5,0	LH040
GNDL R/L 2020 K 1.516	●	●	20	20	125	20	20	38,0	1,50	16	32	GCM N150005 GF			
GNDL R/L 2020 K 220	●	●	20	20	125	20	20	44,5	2,00	20	40	GCM □20○-□□			
GNDL R/L 2020 K 320	●	●	20	20	125	20	20	44,5	3,00	20(18)	40	GCM □30○-□□			
GNDL R/L 2020 K 425	●	●	20	20	125	20	20	50,0	4,00	25(23)	50	GCM □40○-□□			
GNDL R/L 2020 K 525	●	●	20	20	125	20	20	50,0	5,00	25(23)	50	GCM N50○-□□			
GNDL R/L 2020 K 625	●	●	20	20	125	20	20	50,0	6,00	25(23)	50	GCM N60○-□□			
GNDL R/L 2525 M 1.2516	●	●	25	25	150	25	25	40,0	1,25	16	32	GCM N125005 GF			
GNDL R/L 2525 M 1.516	●	●	25	25	150	25	25	40,0	1,50	16	32	GCM N150005 GF			
GNDL R/L 2525 M 220	●	●	25	25	150	25	25	44,5	2,00	20	40	GCM □20○-□□			
GNDL R/L 2525 M 320	●	●	25	25	150	25	25	44,5	3,00	20(18)	40	GCM □30○-□□			
GNDL R/L 2525 M 425	●	●	25	25	150	25	25	50,0	4,00	25(23)	50	GCM □40○-□□			
GNDL R/L 2525 M 525	●	●	25	25	150	25	25	50,0	5,00	25(23)	50	GCM N50○-□□			
GNDL R/L 2525 M 625	●	●	25	25	150	25	25	50,0	6,00	25(23)	50	GCM N60○-□□			
GNDL R/L 3225 P 320			32	25	170	25	32	44,5	3,00	20(18)	40	GCM □30○-□□	BX0520	6,0	LH050
GNDL R/L 3225 P 425			32	25	170	25	32	50,0	4,00	25(23)	50	GCM □40○-□□			
GNDL R/L 3225 P 525			32	25	170	25	32	50,0	5,00	25(23)	50	GCM N50○-□□			
GNDL R/L 3225 P 625			32	25	170	25	32	50,0	6,00	25(23)	50	GCM N60○-□□			
GNDL R/L 3225 P 725			32	25	170	25	32	50,0	7,00	25(23)	50	GCM N70○-□□			
GNDL R/L 3225 P 825			32	25	170	25	32	50,0	8,00	25(23)	50	GCM N80○-□□			
GNDL R/L 3232 P 320	●	●	32	32	170	32	32	44,5	3,00	20(18)	40	GCM □30○-□□	BX0620	6,0	LH050
GNDL R/L 3232 P 425	●	●	32	32	170	32	32	50,0	4,00	25(23)	50	GCM □40○-□□			
GNDL R/L 3232 P 525	●	●	32	32	170	32	32	50,0	5,00	25(23)	50	GCM N50○-□□			
GNDL R/L 3232 P 625	●	●	32	32	170	32	32	50,0	6,00	25(23)	50	GCM N60○-□□			
GNDL R/L 3232 P 725	●	●	32	32	170	32	32	50,0	7,00	25(23)	50	GCM N70○-□□			
GNDL R/L 3232 P 825	●	●	32	32	170	32	32	50,0	8,00	25(23)	50	GCM N80○-□□			

Select holders and inserts with the same grooving width (CW). Dimensions in parentheses are for applications that use copying inserts (RG type breakers).

## External L-Styled (Side Cut) Grooving

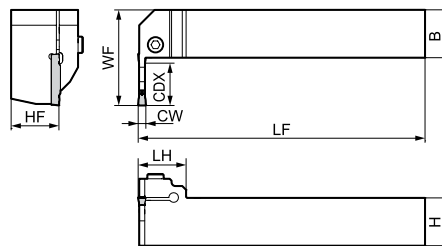
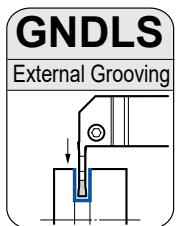

Above figures show right hand tools.

### ■ Spare Parts



### ■ Holders

Cat. No.	Stock		Dimensions (mm)						Grooving Width (mm)	Max. Groov. Depth (mm)	Applicable Insert	Cap Screw	N·m	Spanner
	R	L	H	B	LF	WF	HF	LH						
GNDLS R/L 2020 K 216	●	●	20	20	125	38	20	25	2,0	16	GCM □20○-□□	BX0520	5,0	LH040
GNDLS R/L 2020 K 316	○	●	20	20	125	38	20	25	3,0	16	GCM □30○-□□			
GNDLS R/L 2525 M 218	●	●	25	25	150	45	25	25	2,0	18	GCM □20○-□□			
GNDLS R/L 2525 M 318	●	●	25	25	150	45	25	25	3,0	18	GCM □30○-□□			
GNDLS R/L 2525 M 423	●	●	25	25	150	50	25	25	4,0	23	GCM □40○-□□			
GNDLS R/L 2525 M 523	○	○	25	25	150	50	25	25	5,0	23	GCM N50○-□□			
GNDLS R/L 2525 M 623	●	○	25	25	150	50	25	25	6,0	23	GCM N60○-□□			

Select holders and inserts with the same grooving width (CW).

## Inserts for GNDL / GNDLS

Coated Carbide    Cermet    Carbide

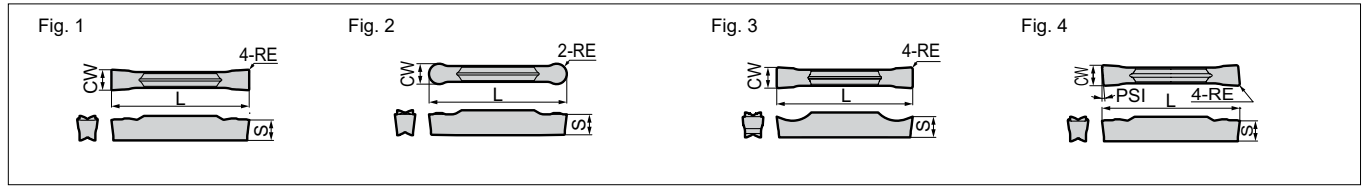

### Grooving / Traversing

Dimensions (mm)

Cat. No.	AC8025P	AC8035P	AC830P	AC425K	AC5015S	AC5025S	AC520U	AC530U	T2500A	CW		RE	L	S	Fig.
										Cutting Width	Tolerance				
GCM N3002 MG	●	●	○	○	●	●	○	○	○	3,0	±0.03	0,2	21,1	3,8	1
N3004 MG	●	●	○	○	●	●	○	○	○	±0.03	0,4	21,1	3,8		
N4002 MG	●	●	○	○	●	●	○	○	○	±0.03	0,2	26,4	4,0		
N4004 MG	●	●	○	○	●	●	○	○	○	4,0	±0.03	0,4	26,4	4,0	
N4008 MG	●	●	○	○	●	●	○	○	○	±0.03	0,8	26,4	4,0		
N5004 MG	●	●	○	○	●	●	○	○	○	±0.03	0,4	26,4	4,1		
N5008 MG	●	●	○	○	●	●	○	○	○	5,0	±0.03	0,8	26,4	4,1	
N6004 MG	●	●	○	○	●	●	○	○	○	±0.03	0,4	26,4	4,5		
N6008 MG	●	●	○	○	●	●	○	○	○	6,0	±0.03	0,8	26,4	4,5	
N7004 MG	●	●	○	○	●	●	○	○	○	±0.03	0,4	28,8	5,5		
N7008 MG	●	●	○	○	●	●	○	○	○	7,0	±0.04	0,8	28,8	5,5	
N8004 MG	●	●	○	○	●	●	○	○	○	±0.04	0,4	28,8	6,0	1	
N8008 MG	●	●	○	○	●	●	○	○	○	±0.04	0,8	28,8	6,0		
GCM N2002 ML	○	○	○	○	○	○	○	○	○	2,0	±0.03	0,2	21,1		3,6
N3002 ML	●	●	○	○	●	●	○	○	○	±0.03	0,2	21,1	3,8		
N3004 ML	●	●	○	○	●	●	○	○	○	3,0	±0.03	0,4	21,1		3,8
N4002 ML	●	●	○	○	●	●	○	○	○	±0.03	0,2	26,4	4,0		
N4004 ML	●	●	○	○	●	●	○	○	○	4,0	±0.03	0,4	26,4		4,0
N4008 ML	●	●	○	○	●	●	○	○	○	±0.03	0,8	26,4	4,0		
N5004 ML	●	●	○	○	●	●	○	○	○	±0.03	0,4	26,4	4,1		
N5008 ML	●	●	○	○	●	●	○	○	○	5,0	±0.03	0,8	26,4		4,1
N6004 ML	●	●	○	○	●	●	○	○	○	±0.03	0,4	26,4	4,5	1	
N6008 ML	●	●	○	○	●	●	○	○	○	6,0	±0.03	0,8	26,4		4,5
N7004 ML	●	●	○	○	●	●	○	○	○	±0.03	0,4	28,8	5,5		
N7008 ML	●	●	○	○	●	●	○	○	○	7,0	±0.04	0,8	28,8		5,5
N8004 ML	●	●	○	○	●	●	○	○	○	±0.03	0,4	28,8	6,0		
N8008 ML	●	●	○	○	●	●	○	○	○	8,0	±0.04	0,8	28,8		6,0

### Grooving / Cut-Off Machining

Dimensions (mm)

Cat. No.	AC8035P	AC830P	AC5015S	AC5025S	AC520U	AC530U	T2500A	CW		RE	L	S	Fig.
								Cutting Width	Tolerance				
GCM N2002 GG	●	●	●	●	○	○	○	2,0	±0.03	0,2	21,1	3,6	1
N3002 GG	●	●	●	●	○	○	○	±0.03	0,2	21,1	3,8		
N3004 GG	●	●	●	●	○	○	○	3,0	±0.03	0,4	21,1	3,8	
N4002 GG	●	●	●	●	○	○	○	4,0	±0.03	0,2	26,4	4,0	
N4004 GG	●	●	●	●	○	○	○	±0.03	0,4	26,4	4,0		
N5002 GG	●	●	●	●	○	○	○	5,0	±0.03	0,2	26,4	4,1	
N5004 GG	●	●	●	●	○	○	○	±0.03	0,4	26,4	4,1		
N6002 GG	●	●	●	●	○	○	○	6,0	±0.03	0,2	26,4	4,5	
N6004 GG	●	●	●	●	○	○	○	±0.03	0,4	26,4	4,5		
N7004 GG	●	○	●	●	○	○	○	7,0	±0.04	0,4	28,8	5,5	
N8004 GG	●	●	●	●	○	○	○	8,0	±0.04	0,4	28,8	6,0	
GCM N2002 GL	●	●	●	●	○	○	○	2,0	±0.03	0,2	21,1	3,6	1
N2004 GL	●	●	●	●	○	○	○	±0.03	0,4	21,1	3,6		
N3002 GL	●	●	●	●	○	○	○	3,0	±0.03	0,2	21,1	3,8	
N3004 GL	●	●	●	●	○	○	○	±0.03	0,4	21,1	3,8		
N4002 GL	●	●	●	●	○	○	○	4,0	±0.03	0,2	26,4	4,0	
N4004 GL	●	●	●	●	○	○	○	±0.03	0,4	26,4	4,0		
N5002 GL	●	●	●	●	○	○	○	5,0	±0.03	0,2	26,4	4,1	
N5004 GL	●	●	●	●	○	○	○	±0.03	0,4	26,4	4,1		
N6002 GL	●	●	●	●	○	○	○	6,0	±0.03	0,2	26,4	4,5	
N6004 GL	●	●	●	●	○	○	○	±0.03	0,4	26,4	4,5		
N7004 GL	●	○	●	●	○	○	○	7,0	±0.04	0,4	28,8	5,5	
N8004 GL	●	○	●	●	○	○	○	8,0	±0.04	0,4	28,8	6,0	
GCM N125005 GF	○	○	○	○	○	○	○	1,25	±0.03	0,05	17,4	3,2	1
N150005 GF	○	○	○	○	○	○	○	1,5	±0.03	0,05	17,4	3,7	
GCM N2002 GF	○	○	○	○	○	○	○	2,0	±0.03	0,2	21,1	3,6	1
N2004 GF	○	○	○	○	○	○	○	±0.03	0,4	21,1	3,6		
N3002 GF	●	●	●	●	○	○	○	3,0	±0.03	0,2	21,1	3,8	
N3004 GF	●	●	●	●	○	○	○	±0.03	0,4	21,1	3,8		
N4002 GF	●	●	●	●	○	○	○	4,0	±0.03	0,2	26,4	4,0	
N4004 GF	●	●	●	●	○	○	○	±0.03	0,4	26,4	4,0		
N5002 GF	●	●	●	●	○	○	○	5,0	±0.03	0,2	26,4	4,1	
N5004 GF	●	●	●	●	○	○	○	±0.03	0,4	26,4	4,1		
N6002 GF	●	●	●	●	○	○	○	6,0	±0.03	0,2	26,4	4,5	
N6004 GF	●	●	●	●	○	○	○	±0.03	0,4	26,4	4,5		
N7002 GF	●	●	●	●	○	○	○	7,0	±0.04	0,2	28,8	5,5	
N7004 GF	●	●	●	●	○	○	○	±0.04	0,4	28,8	5,5		
N8002 GF	●	●	●	●	○	○	○	8,0	±0.04	0,2	28,8	6,0	
N8004 GF	●	●	●	●	○	○	○	±0.04	0,4	28,8	6,0		

### External Profiling / External Radius Grooving

Dimensions (mm)

Cat. No.	AC8025P	AC8035P	AC830P	AC425K	AC5015S	AC5025S	AC520U	AC530U	T2500A	CW		RE	L	S	Fig.
										Cutting Width	Tolerance				
GCM N3015 RG	●	●	○	○	●	●	○	○	○	3,0	±0.03	1,5	21,1	3,8	2
N4020 RG	●	●	○	○	●	●	○	○	○	4,0	±0.03	2,0	26,4	4,0	
N5025 RG	●	●	○	○	●	●	○	○	○	5,0	±0.03	2,5	27,2	4,1	
N6030 RG	●	●	○	○	●	●	○	○	○	6,0	±0.03	3,0	27,5	4,5	
N7035 RG	●	●	○	○	●	●	○	○	○	7,0	±0.04	3,5	29,1	5,5	
N8040 RG	●	●	○	○	●	●	○	○	○	8,0	±0.04	4,0	29,3	6,0	

### Cut-Off Machining (Handed Edge)

Dimensions (mm)

Cat. No.	AC8035P	AC830P	AC5015S	AC5025S	AC520U	AC530U	AC1030U	PSI	CW		RE	L	S	Fig.
									Cutting Width	Tolerance				
GCM R2002 CG 05	●	●	●	●	○	○	○	5°	2,0	±0.03	0,2	21,1	3,6	4
L2002 CG 05	●	●	●	●	○	○	○	5°	2,0	±0.03	0,2	21,1	3,6	
GCM R3002 CG 05	●	●	●	●	○	○	○	5°	3,0	±0.03	0,2	21,3	3,8	
L3002 CG 05	●	●	●	●	○	○	○	5°	3,0	±0.03	0,2	21,3	3,8	
GCM R4002 CG 05	●	●	●	●	○	○	○	5°	4,0	±0.04	0,2	26,7	4,0	
L4002 CG 05	●	●	●	●	○	○	○	5°	4,0	±0.04	0,2	26,7	4,0	
GCM R2003 CF 10	○	○	○	○	○	○	○	10°	2,0	±0.08	0,03	22,4	3,6	
L2003 CF 10	○	○	○	○	○	○	○	10°	2,0	±0.08	0,03	22,4	3,6	
GCM R3003 CF 10	○	○	○	○	○	○	○	10°	3,0	±0.08	0,03	22,4	3,8	
L3003 CF 10	○	○	○	○	○	○	○	10°	3,0	±0.08	0,03	22,4	3,8	
GCM R2003 CF 15	○	○	○	○	○	○	○	15°	2,0	±0.08	0,03	22,4	3,6	4
L2003 CF 15	○	○	○	○	○	○	○	15°	2,0	±0.08	0,03	22,4	3,6	
GCM R3003 CF 15	○	○	○	○	○	○	○	15°	3,0	±0.08	0,03	22,4	3,8	
L3003 CF 15	○	○	○	○	○	○	○	15°	3,0	±0.08	0,03	22,4	3,8	

GCM R: Right hand    GCM L: Left hand  
Combine the insert with a holder such that the width of cut (CW) matches.

### Profiling / Radius Grooving / Necking

Dimensions (mm)

Cat. No.	AC8025P	AC8035P	AC830P	AC425K	AC501
----------	---------	---------	--------	--------	-------

# Grooving Tool Holders

## GNDL-JE Type

Holder with Internal Coolant

### External Deep Grooving and Cut-Off

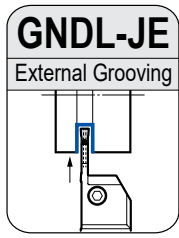

Internal Coolant

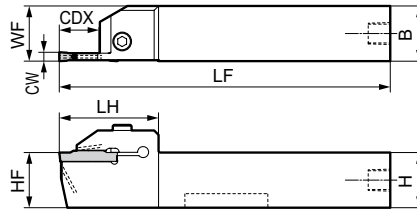

Above figures show right hand tools.

### Spare Parts

Cap Screw	Plug and Sealing	Grub Screw*	Spanner	
BX0520	6,0	XP02-E	BT0505-E	LH040

### Holdings

Cat. No.	Stock		Dimensions (mm)						Grooving Width (mm)	Max. Groov. Depth (mm)	Max. Cutt-Off Dia (mm)	Applicable Insert
	R	L	H	B	LF	WF	HF	LH				
GNDL R/L 2020 X 220 JE	●	●	20	20	110	20	20	44,5	2,00	20	40	GC □ 2000-□□
GNDL R/L 2020 X 320 JE	●	●	20	20	110	20	20	44,5	3,00	20	40	GC □ 3000-□□
GNDL R/L 2020 X 425 JE	●	●	20	20	115	20	20	50,0	4,00	25	50	GC □ 4000-□□
GNDL R/L 2020 X 525 JE	●	●	20	20	115	20	20	50,0	5,00	25	50	GC □ N5000-□□
GNDL R/L 2020 X 625 JE	●	●	20	20	115	20	20	50,0	6,00	25	50	GC □ N6000-□□
GNDL R/L 2525 X 220 JE	●	●	25	25	110	25	25	44,5	2,00	20	40	GC □ 2000-□□
GNDL R/L 2525 X 320 JE	●	●	25	25	110	25	25	44,5	3,00	20	40	GC □ 3000-□□
GNDL R/L 2525 X 425 JE	●	●	25	25	115	25	25	50,0	4,00	25	50	GC □ 4000-□□
GNDL R/L 2525 X 525 JE	●	●	25	25	115	25	25	50,0	5,00	25	50	GC □ N5000-□□
GNDL R/L 2525 X 625 JE	●	●	25	25	115	25	25	50,0	6,00	25	50	GC □ N6000-□□

Select holders and inserts with the same grooving width (CW).

\*Grub screws are sold separately (M5x5)

### Parts (Hose)

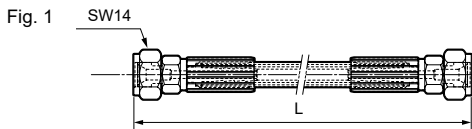

Cat. No.	Stock	L (mm)	Srew Standard	Srew Standard	Fig.
J-HOSE-G1/8-G1/8-200-E	●	200	G1/8	G1/8	1
J-HOSE-G1/8-G1/8-300-E	●	300	G1/8	G1/8	1

Hoses are sold separately.

### Parts (Connector)

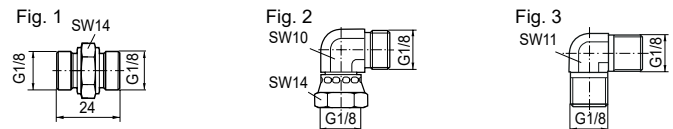

Cat. No.	Stock	Srew Standard	Srew Standard	Fig.
J-G1/8-G1/8-00-E	●	G1/8	G1/8	1
J-G1/8-G1/8F-90-E	●	G1/8	G1/8	2
J-G1/8-G1/8-90-E	●	G1/8	G1/8	3

Connectors are sold separately.

# Grooving Tool Holders GNDL-JE Type

## Inserts for GNDL-JE

Coated Carbide    Cermet    Carbide

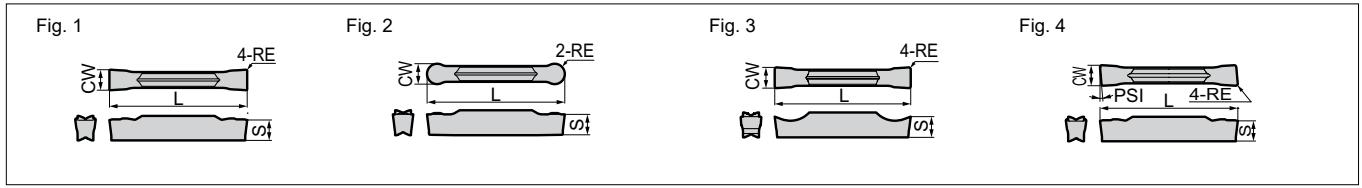

### Grooving / Traversing

Dimensions (mm)

Cat. No.	Insert							CW		RE	L	S	Fig.		
	AC8025P	AC8035P	AC830P	AC425K	AC5015S	AC5025S	AC520U	AC530U	T2500A					Cutting Width	Tolerance
GCM N3002 MG	●	●	●	○	●	●	●	●	—	3,0	±0.03	0,2	21,1	3,8	1
N3004 MG	●	●	●	○	●	●	●	●	—	3,0	±0.03	0,4	21,1	3,8	
N4002 MG	●	●	●	○	●	●	●	●	—	4,0	±0.03	0,2	26,4	4,0	
N4004 MG	●	●	●	○	●	●	●	●	—	4,0	±0.03	0,4	26,4	4,0	
N4008 MG	●	●	●	○	●	●	●	●	—	4,0	±0.03	0,8	26,4	4,0	
N5004 MG	●	●	●	○	●	●	●	●	—	5,0	±0.03	0,4	26,4	4,1	
N5008 MG	●	●	●	○	●	●	●	●	—	5,0	±0.03	0,8	26,4	4,1	
N6004 MG	●	●	●	○	●	●	●	●	—	6,0	±0.03	0,4	26,4	4,5	
N6008 MG	●	●	●	○	●	●	●	●	—	6,0	±0.03	0,8	26,4	4,5	
GCM N2002 ML	—	—	—	—	●	●	●	●	○	2,0	±0.03	0,2	21,1	3,6	1
N3002 ML	—	—	—	—	●	●	●	●	○	3,0	±0.03	0,2	21,1	3,8	
N3004 ML	—	—	—	—	●	●	●	●	○	3,0	±0.03	0,4	21,1	3,8	
N4002 ML	—	—	—	—	●	●	●	●	○	4,0	±0.03	0,2	26,4	4,0	
N4004 ML	—	—	—	—	●	●	●	●	○	4,0	±0.03	0,4	26,4	4,0	
N4008 ML	—	—	—	—	●	●	●	●	○	4,0	±0.03	0,8	26,4	4,0	
N5004 ML	—	—	—	—	●	●	●	●	○	5,0	±0.03	0,4	26,4	4,1	
N5008 ML	—	—	—	—	●	●	●	●	○	5,0	±0.03	0,8	26,4	4,1	
N6004 ML	—	—	—	—	●	●	●	●	○	6,0	±0.03	0,4	26,4	4,5	
N6008 ML	—	—	—	—	●	●	●	●	○	6,0	±0.03	0,8	26,4	4,5	

### Grooving / Cut-Off Machining

Dimensions (mm)

Cat. No.	Insert							CW		RE	L	S	Fig.
	AC8035P	AC830P	AC5015S	AC5025S	AC520U	AC530U	T2500A	Cutting Width	Tolerance				
GCM N2002 GG	●	●	●	●	●	●	—	2,0	±0.03	0,2	21,1	3,6	1
N3002 GG	●	●	●	●	●	●	—	3,0	±0.03	0,2	21,1	3,8	
N3004 GG	●	●	●	●	○	●	—	3,0	±0.03	0,4	21,1	3,8	
N4002 GG	●	●	●	●	○	●	—	4,0	±0.03	0,2	26,4	4,0	
N4004 GG	●	●	●	●	○	●	—	4,0	±0.03	0,4	26,4	4,0	
N5002 GG	●	●	●	●	○	●	—	5,0	±0.03	0,2	26,4	4,1	
N5004 GG	●	●	●	●	○	●	—	5,0	±0.03	0,4	26,4	4,1	
N6002 GG	●	●	●	●	○	●	—	6,0	±0.03	0,2	26,4	4,5	
N6004 GG	●	●	●	●	○	●	—	6,0	±0.03	0,4	26,4	4,5	
GCM N2002 GL	●	●	●	●	○	●	—	2,0	±0.03	0,2	21,1	3,6	1
N2004 GL	●	●	●	●	○	●	—	2,0	±0.03	0,4	21,1	3,6	
N3002 GL	●	●	●	●	○	●	—	3,0	±0.03	0,2	21,1	3,8	
N3004 GL	●	●	●	●	○	●	—	3,0	±0.03	0,4	21,1	3,8	
N4002 GL	●	●	●	●	○	●	—	4,0	±0.03	0,2	26,4	4,0	
N4004 GL	●	●	●	●	○	●	—	4,0	±0.03	0,4	26,4	4,0	
N5002 GL	●	●	●	●	○	●	—	5,0	±0.03	0,2	26,4	4,1	
N5004 GL	●	●	●	●	○	●	—	5,0	±0.03	0,4	26,4	4,1	
N6002 GL	●	●	●	●	○	●	—	6,0	±0.03	0,2	26,4	4,5	
N6004 GL	●	●	●	●	○	●	—	6,0	±0.03	0,4	26,4	4,5	
GCM N2002 GF	—	—	●	●	●	●	○	2,0	±0.03	0,2	21,1	3,6	1
N2004 GF	—	—	●	●	●	●	○	2,0	±0.03	0,4	21,1	3,6	
N3002 GF	—	—	●	●	●	●	○	3,0	±0.03	0,2	21,1	3,8	
N3004 GF	—	—	●	●	●	●	○	3,0	±0.03	0,4	21,1	3,8	
N4002 GF	—	—	●	●	●	●	○	4,0	±0.03	0,2	26,4	4,0	
N4004 GF	—	—	●	●	●	●	○	4,0	±0.03	0,4	26,4	4,0	
N5002 GF	—	—	●	●	●	●	○	5,0	±0.03	0,2	26,4	4,1	
N5004 GF	—	—	●	●	●	●	○	5,0	±0.03	0,4	26,4	4,1	
N6002 GF	—	—	●	●	●	●	○	6,0	±0.03	0,2	26,4	4,5	
N6004 GF	—	—	●	●	●	●	○	6,0	±0.03	0,4	26,4	4,5	

### External Profiling / External Radius Grooving

Dimensions (mm)

Cat. No.	Insert							CW		RE	L	S	Fig.
	AC8025P	AC8035P	AC830P	AC425K	AC5015S	AC5025S	AC520U	AC530U	T2500A				
GCM N3015 RG	●	●	●	●	●	●	○	3,0	±0.03	1,5	21,1	3,8	2
N4020 RG	●	●	●	●	●	●	○	4,0	±0.03	2,0	26,4	4,0	
N5025 RG	●	●	●	●	●	●	○	5,0	±0.03	2,5	27,2	4,1	
N6030 RG	●	●	●	●	●	●	○	6,0	±0.03	3,0	27,5	4,5	

### Cut-Off Machining (Handed Edge)

Dimensions (mm)

Cat. No.	Insert							PSI	CW		RE	L	S	Fig.
	AC8035P	AC830P	AC5015S	AC5025S	AC520U	AC530U	AC1030U		Cutting Width	Tolerance				
GCM R2002 CG 05	●	●	●	●	○	●	—	5°	2,0	±0.03	0,2	21,1	3,6	4
L2002 CG 05	●	●	●	●	○	●	—	5°	2,0	±0.03	0,2	21,1	3,6	
GCM R3002 CG 05	●	●	●	●	○	●	—	5°	3,0	±0.03	0,2	21,3	3,8	
L3002 CG 05	●	●	●	●	○	●	—	5°	3,0	±0.03	0,2	21,3	3,8	
GCM R4002 CG 05	●	●	●	●	○	●	—	5°	4,0	±0.04	0,2	26,7	4,0	
L4002 CG 05	●	●	●	●	○	●	—	5°	4,0	±0.04	0,2	26,7	4,0	
GCM R2003 CF 10	—	—	●	●	—	—	●	10°	2,0	±0.08	0,03	22,4	3,6	
L2003 CF 10	—	—	●	●	—	—	●	10°	2,0	±0.08	0,03	22,4	3,6	
GCM R3003 CF 10	—	—	●	●	—	—	●	10°	3,0	±0.08	0,03	22,4	3,8	
L3003 CF 10	—	—	●	●	—	—	●	10°	3,0	±0.08	0,03	22,4	3,8	
GCM R2003 CF 15	—	—	●	●	—	—	●	15°	2,0	±0.08	0,03	22,4	3,6	4
L2003 CF 15	—	—	●	●	—	—	●	15°	2,0	±0.08	0,03	22,4	3,6	
GCM R3003 CF 15	—	—	●	●	—	—	●	15°	3,0	±0.08	0,03	22,4	3,8	
L3003 CF 15	—	—	●	●	—	—	●	15°	3,0	±0.08	0,03	22,4	3,8	

GCM R: Right hand    GCM L: Left hand  
Combine the insert with a holder such that the width of cut (CW) matches.

### Profiling / Radius Grooving / Necking

Dimensions (mm)

Cat. No.	Insert							CW		RE	L	S	Fig.
	AC8025P	AC8035P	AC830P	AC425K	AC5015S	AC5025S	AC520U	AC530U	T2500A				
GCM N2010 RN	—	—	—	—	●	●	○	2,0	±0.03	1,0	21,7	3,6	2
N3015 RN	—	—	—	—	●	●	○	3,0	±0.03	1,5	22,6	3,8	
N4020 RN	—	—	—	—	●	●	○	4,0	±0.03	2,0	28,2	4,0	
N5025 RN	—	—	—	—	●	●	○	5,0	±0.03	2,5	28,3	4,1	
N6030 RN	—	—	—	—	●	●	○	6,0	±0.03	3,0	28,3	4,5	

### Non-Ferrous Metals

Dimensions (mm)

Cat. No.	H1	Insert							CW		RE	L	S	Fig.
		AC8025P	AC8035P	AC830P	AC425K	AC5015S	AC5025S	AC520U	AC530U	T2500A				
GCG N2002 GA	○	—	—	—	—	—	—	2,0	±0.025	0,2	21,1	3,6	3	
N3002 GA	○	—	—	—	—	—	—	3,0	±0.025	0,2	21,1	3,8		
N4004 GA	○	—	—	—	—	—	—	4,0	±0.025	0,4	26,4	4,0		
N5004 GA	○	—	—	—	—	—	—	5,0	±0.025	0,4	26,4	4,1		
N6004 GA	○	—	—	—	—	—	—	6,0	±0.025	0,4	26,4	4,5		

# Grooving Tool Holders

## GNDN Type

### Necking

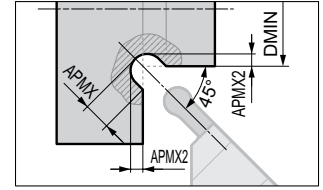
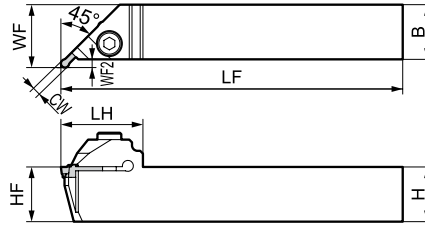
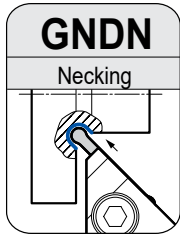

Above figures show right hand tools.

### ■ Spare Parts



### ■ Holders

Cat. No.	Stock		Dimensions (mm)							Min. Bore (mm)	Groov. Width (mm)	APMX	APMX2	Applicable Insert	Cap Screw	N·m	Spanner
	R	L	H	B	LF	WF	HF	LH	WF2								
GNDN R/L2020 K 215-020	○	○	20	20	125	23	20	30	3,0	20	2,0	1,5	0,64	GCM N2010 RN			
GNDN R/L2020 K 320-020	○	○	20	20	125	23	20	30	3,0	20	3,0	2,0	0,79	GCM N3015 RN			
GNDN R/L2020 K 430-030	○	○	20	20	125	24	20	32	4,0	30	4,0	3,0	1,29	GCM N4020 RN	BX0520	5,0	LH040
GNDN R/L2020 K 535-030	○	○	20	20	125	25	20	35	5,0	30	5,0	3,5	1,44	GCM N5025 RN			
GNDN R/L2020 K 640-030	○	○	20	20	125	25	20	35	5,0	30	6,0	4,0	1,59	GCM N6030 RN			
GNDN R/L2525 M 215-020	○	○	25	25	150	28	25	30	3,0	20	2,0	1,5	0,64	GCM N2010 RN			
GNDN R/L2525 M 320-020	○	○	25	25	150	28	25	30	3,0	20	3,0	2,0	0,79	GCM N3015 RN			
GNDN R/L2525 M 430-030	○	○	25	25	150	29	25	32	4,0	30	4,0	3,0	1,29	GCM N4020 RN	BX0520	5,0	LH040
GNDN R/L2525 M 535-030	○	○	25	25	150	30	25	35	5,0	30	5,0	3,5	1,44	GCM N5025 RN			
GNDN R/L2525 M 640-030	○	○	25	25	150	30	25	35	5,0	30	6,0	4,0	1,59	GCM N6030 RN			

Select holders and inserts with the same grooving width (CW).

## ■ Inserts for GNDN

Coated Carbide

Cermet

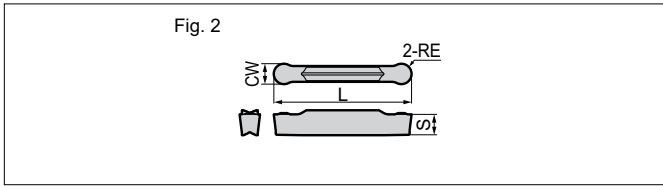

## ● Profiling / Radius Grooving / Necking

Dimensions (mm)



Cat. No.	AC8025P	AC8035P	AC830P	AC425K	AC5015S	AC5025S	AC520U	AC530U	T2500A	CW		RE	L	S	Fig.
										Cutting Width	Tolerance				
GCM N2010 RN	—	—	—	—	●	●	○	○	—	2,0	±0,03	1,0	21,7	3,6	2
N3015 RN	●	●	●	○	●	●	○	○	—	3,0	±0,03	1,5	22,6	3,8	
N4020 RN	●	●	●	○	●	●	○	○	—	4,0	±0,03	2,0	28,2	4,0	
N5025 RN	●	●	●	○	●	●	○	○	—	5,0	±0,03	2,5	28,3	4,1	
N6030 RN	●	●	●	○	●	●	○	○	—	6,0	±0,03	3,0	28,3	4,5	

Select holders and inserts with the same grooving width (CW).



# Grooving Tool Holders GNDF Type

## Face Grooving

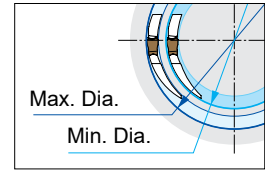
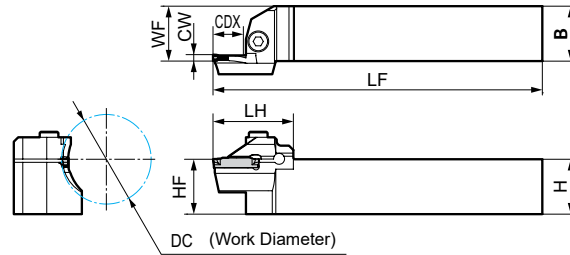
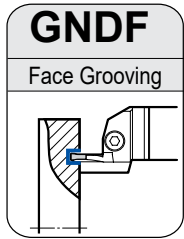

Work diameters in the stock indicate external diameters of face grooving.

Use for multi-purpose or profiling insert for turning (wide grooves).

Above figures show right hand tools.

### ■ Holders

### ■ Spare Parts

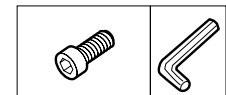

Cat. No.	Stock		Dimensions (mm)						Work Dia. (mm)	Groov. Width (mm)	Max. Cut-off Dia. (mm)	Applicable Insert	Cap Screw	N-m	Spanner
	R	L	H	B	LF	WF	HF	LH							
GNDF R/L 2020 K 312-035	●	●	20	20	125	20	20	35,6	35-45	3,0	12	GCM N300O-□□	BX0520	5,0	LH040
GNDF R/L 2020 K 312-040	●	●	20	20	125	20	20	35,6	40-55	3,0	12				
GNDF R/L 2020 K 318-050	●	●	20	20	125	20	20	41,6	50-70	3,0	18				
GNDF R/L 2020 K 318-065	●	●	20	20	125	20	20	41,6	65-100	3,0	18				
GNDF R/L 2020 K 318-090	●	●	20	20	125	20	20	41,6	90-150	3,0	18				
GNDF R/L 2020 K 318-140	●	●	20	20	125	20	20	41,6	140-200	3,0	18				
GNDF R/L 2020 K 318-180	●	●	20	20	125	20	20	41,6	180-300	3,0	18				
GNDF R/L 2020 K 418-040	●	●	20	20	125	20	20	41,6	40-55	4,0	18	GCM N400O-□□	BX0520	5,0	LH040
GNDF R/L 2020 K 423-050	●	●	20	20	125	20	20	46,6	50-70	4,0	23				
GNDF R/L 2020 K 423-065	●	●	20	20	125	20	20	46,6	65-90	4,0	23				
GNDF R/L 2020 K 423-085	●	○	20	20	125	20	20	46,6	85-130	4,0	23				
GNDF R/L 2020 K 423-125	○	●	20	20	125	20	20	46,6	125-200	4,0	23				
GNDF R/L 2020 K 423-180	○	○	20	20	125	20	20	46,6	180-300	4,0	23				
GNDF R/L 2020 K 423-280	○	○	20	20	125	20	20	46,6	280-1000	4,0	23				
GNDF R/L 2020 K 523-050	○	○	20	20	125	20	20	46,6	50-70	5,0	23	GCM N500O-□□	BX0520	5,0	LH040
GNDF R/L 2020 K 523-065	○	●	20	20	125	20	20	46,6	65-90	5,0	23				
GNDF R/L 2020 K 523-085	●	○	20	20	125	20	20	46,6	85-130	5,0	23				
GNDF R/L 2020 K 523-125	●	●	20	20	125	20	20	46,6	125-200	5,0	23				
GNDF R/L 2020 K 523-180	○	○	20	20	125	20	20	46,6	180-300	5,0	23				
GNDF R/L 2020 K 523-280	○	○	20	20	125	20	20	46,6	280-1000	5,0	23				
GNDF R/L 2020 K 623-050	○	○	20	20	125	20	20	46,6	50-75	6,0	23	GCM N600O-□□	BX0520	5,0	LH040
GNDF R/L 2020 K 623-070	○	○	20	20	125	20	20	46,6	70-110	6,0	23				
GNDF R/L 2020 K 623-100	○	●	20	20	125	20	20	46,6	100-200	6,0	23				
GNDF R/L 2020 K 623-180	○	○	20	20	125	20	20	46,6	180-300	6,0	23				
GNDF R/L 2020 K 623-280	○	○	20	20	125	20	20	46,6	280-1000	6,0	23				
GNDF R/L 2525 M 312-035	●	●	25	25	150	25	25	35,6	35-45	3,0	12				
GNDF R/L 2525 M 312-040	●	●	25	25	150	25	25	35,6	40-55	3,0	12				
GNDF R/L 2525 M 318-050	●	●	25	25	150	25	25	41,6	50-70	3,0	18				
GNDF R/L 2525 M 318-065	●	●	25	25	150	25	25	41,6	65-100	3,0	18				
GNDF R/L 2525 M 318-090	●	●	25	25	150	25	25	41,6	90-150	3,0	18				
GNDF R/L 2525 M 318-140	●	●	25	25	150	25	25	41,6	140-200	3,0	18				
GNDF R/L 2525 M 318-180	●	●	25	25	150	25	25	41,6	180-300	3,0	18				
GNDF R/L 2525 M 418-040	●	●	25	25	150	25	25	41,6	40-55	4,0	18	GCM N400O-□□	BX0520	5,0	LH040
GNDF R/L 2525 M 423-050	●	●	25	25	150	25	25	46,6	50-70	4,0	23				
GNDF R/L 2525 M 423-065	●	●	25	25	150	25	25	46,6	65-90	4,0	23				
GNDF R/L 2525 M 423-085	●	●	25	25	150	25	25	46,6	85-130	4,0	23				
GNDF R/L 2525 M 423-125	●	●	25	25	150	25	25	46,6	125-200	4,0	23				
GNDF R/L 2525 M 423-180	●	●	25	25	150	25	25	46,6	180-300	4,0	23				
GNDF R/L 2525 M 423-280	●	●	25	25	150	25	25	46,6	280-1000	4,0	23				
GNDF R/L 2525 M 523-050	●	●	25	25	150	25	25	46,6	50-70	5,0	23	GCM N500O-□□	BX0520	5,0	LH040
GNDF R/L 2525 M 523-065	●	●	25	25	150	25	25	46,6	65-90	5,0	23				
GNDF R/L 2525 M 523-085	●	●	25	25	150	25	25	46,6	85-130	5,0	23				
GNDF R/L 2525 M 523-125	●	●	25	25	150	25	25	46,6	125-200	5,0	23				
GNDF R/L 2525 M 523-180	●	●	25	25	150	25	25	46,6	180-300	5,0	23				
GNDF R/L 2525 M 523-280	●	●	25	25	150	25	25	46,6	280-1000	5,0	23				
GNDF R/L 2525 M 623-050	●	○	25	25	150	25	25	46,6	50-75	6,0	23	GCM N600O-□□	BX0520	5,0	LH040
GNDF R/L 2525 M 623-070	●	●	25	25	150	25	25	46,6	70-110	6,0	23				
GNDF R/L 2525 M 623-100	●	●	25	25	150	25	25	46,6	100-200	6,0	23				
GNDF R/L 2525 M 623-180	○	●	25	25	150	25	25	46,6	180-300	6,0	23				
GNDF R/L 2525 M 623-280	●	●	25	25	150	25	25	46,6	280-1000	6,0	23				

Select holders and inserts with the same grooving width (CW).

## Inserts for GNDF

Coated Carbide    Cermet    Carbide

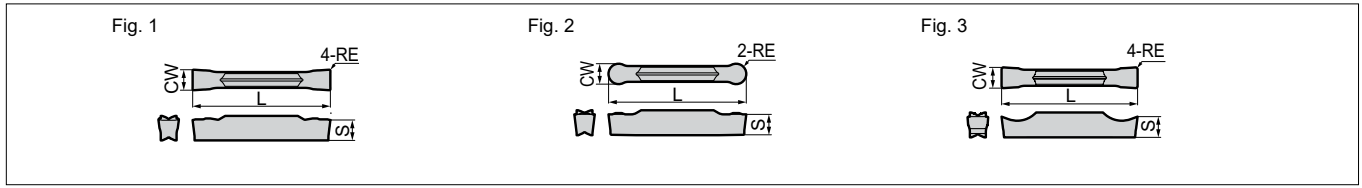

### ● Grooving / Traversing

Dimensions (mm)

Cat. No.	AC8025P	AC8035P	AC830P	AC425K	AC5015S	AC5025S	AC520U	AC530U	T2500A	CW		RE	L	S	Fig.
										Cutting Width	Tolerance				
GCM N3002 MG	●	●	●	○	●	●	○	●	—	3,0	±0,03	0,2	21,1	3,8	1
N3004 MG	●	●	●	○	●	●	○	●	—	±0,03	0,4	21,1	3,8		
N4002 MG	●	●	●	○	●	●	○	●	—	±0,03	0,2	26,4	4,0		
N4004 MG	●	●	●	○	●	●	○	●	—	4,0	±0,03	0,4	26,4	4,0	
N4008 MG	●	●	●	○	●	●	○	●	—	±0,03	0,8	26,4	4,0		
N5004 MG	●	●	●	○	●	●	○	●	—	5,0	±0,03	0,4	26,4	4,1	
N5008 MG	●	●	●	○	●	●	○	●	—	±0,03	0,8	26,4	4,1		
N6004 MG	●	●	●	○	●	●	○	●	—	6,0	±0,03	0,4	26,4	4,5	
N6008 MG	●	●	●	○	●	●	○	●	—	±0,03	0,8	26,4	4,5		
GCM N2002 ML	—	—	—	—	●	●	○	●	—	2,0	±0,03	0,2	21,1	3,6	
N3002 ML	●	●	●	○	●	●	○	●	—	3,0	±0,03	0,2	21,1	3,8	
N3004 ML	●	●	●	○	●	●	○	●	—	±0,03	0,4	21,1	3,8		
N4002 ML	●	●	●	○	●	●	○	●	—	±0,03	0,2	26,4	4,0		
N4004 ML	●	●	●	○	●	●	○	●	—	4,0	±0,03	0,4	26,4	4,0	
N4008 ML	●	●	●	○	●	●	○	●	—	±0,03	0,8	26,4	4,0		
N5004 ML	●	●	●	○	●	●	○	●	—	5,0	±0,03	0,4	26,4	4,1	
N5008 ML	●	●	●	○	●	●	○	●	—	±0,03	0,8	26,4	4,1		
N6004 ML	●	●	●	○	●	●	○	●	—	6,0	±0,03	0,4	26,4	4,5	
N6008 ML	●	●	●	○	●	●	○	●	—	±0,03	0,8	26,4	4,5		

### ● Grooving / Cut-Off Machining

Dimensions (mm)

Cat. No.	AC8035P	AC830P	AC5015S	AC5025S	AC520U	AC530U	T2500A	CW		RE	L	S	Fig.	
								Cutting Width	Tolerance					
GCM N3002 GG	●	●	●	●	○	●	—	3,0	±0,03	0,2	21,1	3,8	1	
N3004 GG	●	●	●	●	○	●	—	±0,03	0,4	21,1	3,8			
N4002 GG	●	●	●	●	○	●	—	±0,03	0,2	26,4	4,0			
N4004 GG	●	●	●	●	○	●	—	4,0	±0,03	0,4	26,4	4,0		
N5002 GG	●	●	●	●	○	●	—	5,0	±0,03	0,2	26,4	4,1		
N5004 GG	●	●	●	●	○	●	—	±0,03	0,4	26,4	4,1			
N6002 GG	●	●	●	●	○	●	—	6,0	±0,03	0,2	26,4	4,5		
N6004 GG	●	●	●	●	○	●	—	±0,03	0,4	26,4	4,5			
GCM N3002 GL	●	●	●	●	○	●	—	3,0	±0,03	0,2	21,1	3,8		1
N3004 GL	●	●	●	●	○	●	—	±0,03	0,4	21,1	3,8			
N4002 GL	●	●	●	●	○	●	—	4,0	±0,03	0,2	26,4	4,0		
N4004 GL	●	●	●	●	○	●	—	±0,03	0,4	26,4	4,0			
N5002 GL	●	●	●	●	○	●	—	5,0	±0,03	0,2	26,4	4,1		
N5004 GL	●	●	●	●	○	●	—	±0,03	0,4	26,4	4,1			
N6002 GL	●	●	●	●	○	●	—	6,0	±0,03	0,2	26,4	4,5		
N6004 GL	●	●	●	●	○	●	—	±0,03	0,4	26,4	4,5			
GCM N3002 GF	●	●	●	●	○	●	—	3,0	±0,03	0,2	21,1	3,8	1	
N3004 GF	●	●	●	●	○	●	—	±0,03	0,4	21,1	3,8			
N4002 GF	●	●	●	●	○	●	—	4,0	±0,03	0,2	26,4	4,0		
N4004 GF	●	●	●	●	○	●	—	±0,03	0,4	26,4	4,0			
N5002 GF	●	●	●	●	○	●	—	5,0	±0,03	0,2	26,4	4,1		
N5004 GF	●	●	●	●	○	●	—	±0,03	0,4	26,4	4,1			
N6002 GF	●	●	●	●	○	●	—	6,0	±0,03	0,2	26,4	4,5		
N6004 GF	●	●	●	●	○	●	—	±0,03	0,4	26,4	4,5			

Combine the insert with a holder such that the width of cut (CW) matches.

### ● Profiling / Radius Grooving / Necking

Dimensions (mm)

Cat. No.	AC8025P	AC8035P	AC830P	AC425K	AC5015S	AC5025S	AC520U	AC530U	T2500A	CW		RE	L	S	Fig.
										Cutting Width	Tolerance				
GCM N3015 RG	●	●	●	●	●	●	○	●	○	3,0	±0,03	1,5	21,1	3,8	2
N4020 RG	●	●	●	●	●	●	○	●	○	4,0	±0,03	2,0	26,4	4,0	
N5025 RG	●	●	●	●	●	●	○	●	—	5,0	±0,03	2,5	27,2	4,1	
N6030 RG	●	●	●	●	●	●	○	●	—	6,0	±0,03	3,0	27,5	4,5	

### ● Non-Ferrous Metals

Dimensions (mm)

Cat. No.	H1	CW		RE	L	S	Fig.
		Cutting Width	Tolerance				
GCG N3002 GA	○	3,0	±0,025	0,2	21,1	3,8	3
N4004 GA	○	4,0	±0,025	0,4	26,4	4,0	
N5004 GA	○	5,0	±0,025	0,4	26,4	4,1	
N6004 GA	○	6,0	±0,025	0,4	26,4	4,5	

# Grooving Tool Holders GNDFS Type

## Face Grooving L-Styled (Non-Adjustable Type)

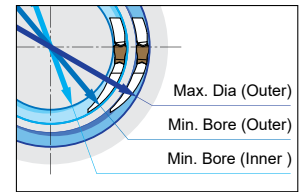
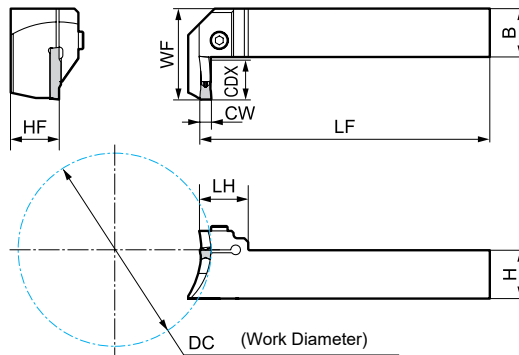
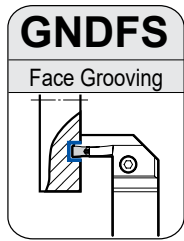

Use the multi-purpose copying inserts for turning (wide grooves).

Above figures show right hand tools.

### Spare Parts

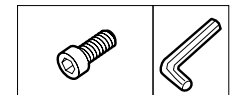

### ■ Holders

Cat. No.	Stock		Dimensions (mm)						Work Dia. (mm)	Min. Bore Ø Inner (mm)	Groov. Width (mm)	Max. Groov. Depth (mm)	Applicable Insert	Cap Screw	N·m	Spanner
	R	L	H	B	LF	WF	HF	LH								
GNDFS R/L2525M 620 070			25	25	150	47	25	25	70-100	58	6,0	20	GC□ N60○○-□□	BX0520	5,0	LH040
GNDFS R/L2525M 620 100			25	25	150	47	25	25	100-200	88	6,0	20				
GNDFS R/L2525M 620 180			25	25	150	47	25	25	180-300	168	6,0	20				
GNDFS R/L2525M 620 280			25	25	150	47	25	25	280-1000	268	6,0	20				
GNDFS R/L2525M 620 450			25	25	150	47	25	25	>450	438	6,0	20				
GNDFS R/L3232P 620 070			32	32	170	54	32	25	70-100	58	6,0	20	GC□ N60○○-□□	BX0620	6,0	LH050
GNDFS R/L3232P 620 100			32	32	170	54	32	25	100-200	88	6,0	20				
GNDFS R/L3232P 620 180			32	32	170	54	32	25	180-300	168	6,0	20				
GNDFS R/L3232P 620 280			32	32	170	54	32	25	280-1000	268	6,0	20				
GNDFS R/L3232P 620 450			32	32	170	54	32	25	>450	438	6,0	20				
GNDFS R/L2525M 820 070			25	25	150	47	25	30	70-100	54	8,0	20	GCM N80○○-□□	BX0620	6,0	LH050
GNDFS R/L2525M 820 100			25	25	150	47	25	30	100-200	84	8,0	20				
GNDFS R/L2525M 820 180			25	25	150	47	25	30	180-300	164	8,0	20				
GNDFS R/L2525M 820 280			25	25	150	47	25	30	280-1000	264	8,0	20				
GNDFS R/L2525M 820 450			25	25	150	47	25	30	>450	434	8,0	20				
GNDFS R/L3232P 820 070			32	32	170	54	32	30	70-100	54	8,0	20	GCM N80○○-□□	BX0620	6,0	LH050
GNDFS R/L3232P 820 100			32	32	170	54	32	30	100-200	84	8,0	20				
GNDFS R/L3232P 820 180			32	32	170	54	32	30	180-300	164	8,0	20				
GNDFS R/L3232P 820 280			32	32	170	54	32	30	280-1000	264	8,0	20				
GNDFS R/L3232P 820 450			32	32	170	54	32	30	>450	434	8,0	20				

Select holders and inserts with the same grooving width (CW).

## Inserts for GNDFS

Coated Carbide    Cermet    Carbide

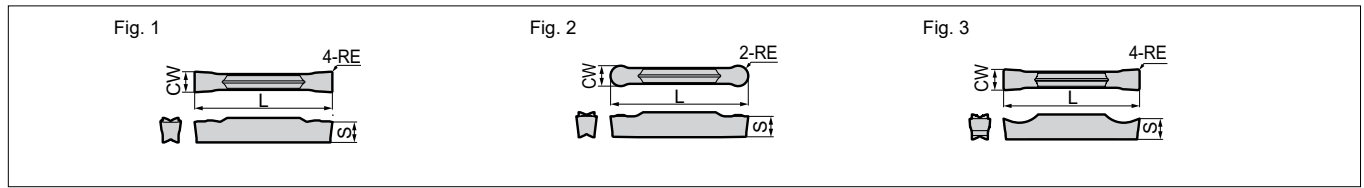

### ● Grooving / Traversing

Dimensions (mm)

Cat. No.	AC8025P	AC8035P	AC830P	AC425K	AC5015S	AC5025S	AC520U	AC530U	T2500A	CW		RE	L	S	Fig.
										Cutting Width	Tolerance				
GCM N6004 MG	●	●	●	○	●	●	○	●	—	6,0	±0,03	0,4	26,4	4,5	1
N6008 MG	●	●	●	○	●	●	○	●	—	6,0	±0,03	0,8	26,4	4,5	
N8004 MG	●	●	●	○	●	●	○	●	—	8,0	±0,04	0,4	28,8	6,0	
N8008 MG	●	●	●	○	●	●	○	●	—	8,0	±0,04	0,8	28,8	6,0	
GCM N6004 ML	●	●	●	○	●	●	○	●	—	6,0	±0,03	0,4	26,4	4,5	1
N6008 ML	●	●	●	○	●	●	○	●	—	6,0	±0,03	0,8	26,4	4,5	
N8004 ML	●	●	●	○	●	●	○	●	—	8,0	±0,04	0,4	28,8	6,0	
N8008 ML	●	●	●	○	●	●	○	●	—	8,0	±0,04	0,8	28,8	6,0	

### ● Grooving / Cut-Off Machining

Dimensions (mm)

Cat. No.	AC8035P	AC830P	AC5015S	AC5025S	AC520U	AC530U	T2500A	CW		RE	L	S	Fig.
								Cutting Width	Tolerance				
GCM N6002 GG	●	●	●	●	○	●	—	6,0	±0,03	0,2	26,4	4,5	1
N6004 GG	●	●	●	●	○	●	—	6,0	±0,03	0,4	26,4	4,5	
N8004 GG	●	●	●	●	○	●	—	8,0	±0,04	0,4	28,8	6,0	
GCM N6002 GL	●	●	●	●	○	●	—	6,0	±0,03	0,2	26,4	4,5	1
N6004 GL	●	●	●	●	○	●	—	6,0	±0,03	0,4	26,4	4,5	
N8004 GL	●	○	●	●	○	●	—	8,0	±0,04	0,4	28,8	6,0	
GCM N6002 GF	●	●	●	●	○	●	—	6,0	±0,03	0,2	26,4	4,5	1
N6004 GF	●	●	●	●	○	●	—	6,0	±0,03	0,4	26,4	4,5	
N8002 GF	●	●	●	●	○	●	—	8,0	±0,04	0,2	28,8	6,0	
N8004 GF	●	●	●	●	○	●	—	8,0	±0,04	0,4	28,8	6,0	

### ● Profiling / Radius Grooving / Necking

Dimensions (mm)

Cat. No.	AC8025P	AC8035P	AC830P	AC425K	AC5015S	AC5025S	AC520U	AC530U	T2500A	CW		RE	L	S	Fig.
										Cutting Width	Tolerance				
GCM N6030 RN	●	●	●	●	●	●	○	●	—	6,0	±0,03	3,0	28,3	4,5	2

Combine the insert with a holder such that the width of cut (CW) matches.

### ● Non-Ferrous Metals

Dimensions (mm)

Cat. No.	H1									CW		RE	L	S	Fig.
										Cutting Width	Tolerance				
GCG N6004 GA	○									6,0	±0,025	0,4	26,4	4,5	3

# Grooving Tool Holders

## GNDI Type

### Internal Grooving

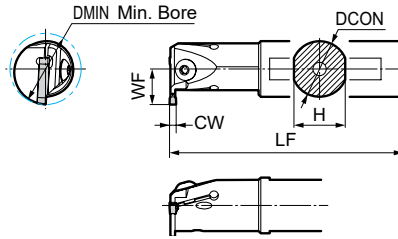
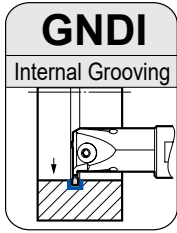

Use for multi-purpose or profiling insert for turning (wide grooves).

Above figures show right hand tools.

### ■ Spare Parts

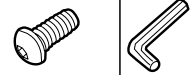

### ■ Holders

Cat. No.	Stock		Dimensions (mm)				Min. Bore (mm)	Groov. Width (mm)	Max. Groov. Depth (mm)	Applicable Insert	Cap Screw	N·m	Spanner
	R	L	DCON	H	LF	WF							
GNDI R/L 2532 T 206	●	●	25	23	200	16	32	2,0	6	GCM N2000-□□	BH0516	5,0	LH030
GNDI R/L 3240 T 210	●	●	32	30	250	26	40	2,0	10	GCM N2000-□□	BH0616	6,0	LH040
GNDI R/L 2532 T 306	●	●	25	23	200	16	32	3,0	6	GCM N3000-□□	BH0516	5,0	LH030
GNDI R/L 3240 T 310	●	●	32	30	250	26	40	3,0	10	GCM N3000-□□	BH0616	6,0	LH040
GNDI R/L 4050 T 311	●	●	40	38	300	31	50	3,0	11	GCM N3000-□□	BH0616	6,0	LH040
GNDI R/L 2532 T 406	●	●	25	23	200	19	32	4,0	6	GCM N4000-□□	BH0516	5,0	LH030
GNDI R/L 3240 T 410	●	●	32	30	250	26	40	4,0	10	GCM N4000-□□	BH0616	6,0	LH040
GNDI R/L 4050 T 411	●	●	40	38	300	31	50	4,0	11	GCM N4000-□□	BH0616	6,0	LH040
GNDI R/L 2532 T 506	●	○	25	23	200	19	32	5,0	6	GCM N5000-□□	BH0516	5,0	LH030
GNDI R/L 3240 T 510	●	●	32	30	250	26	40	5,0	10	GCM N5000-□□	BH0616	6,0	LH040
GNDI R/L 4050 T 511	●	●	40	38	300	31	50	5,0	11	GCM N5000-□□	BH0616	6,0	LH040
GNDI R/L 4050 T 611	●	●	40	38	300	31	50	6,0	11	GCM N6000-□□	BH0616	6,0	LH040

Select holders and inserts with the same grooving width (CW).

## GNDI Inserts

Coated Carbide    Cermet    Carbide

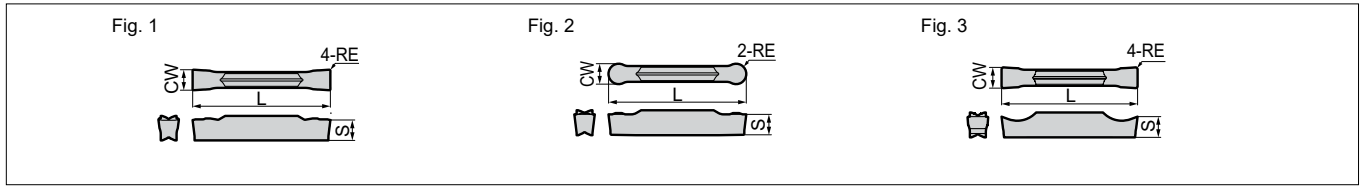

### Grooving / Traversing

Dimensions (mm)

Cat. No.	AC8025P	AC8035P	AC830P	AC425K	AC5015S	AC5025S	AC520U	AC530U	T2500A	CW		RE	L	S	Fig.
										Cutting Width	Tolerance				
GCM N3002 MG	●	●	●	○	●	●	○	●	—	3,0	±0,03	0,2	21,1	3,8	1
N3004 MG	●	●	●	○	●	●	○	●	—	3,0	±0,03	0,4	21,1	3,8	
N4002 MG	●	●	●	○	●	●	○	●	—	4,0	±0,03	0,2	26,4	4,0	
N4004 MG	●	●	●	○	●	●	○	●	—	4,0	±0,03	0,4	26,4	4,0	
N4008 MG	●	●	●	○	●	●	○	●	—	4,0	±0,03	0,8	26,4	4,0	
N5004 MG	●	●	●	○	●	●	○	●	—	5,0	±0,03	0,4	26,4	4,1	
N5008 MG	●	●	●	○	●	●	○	●	—	5,0	±0,03	0,8	26,4	4,1	
N6004 MG	●	●	●	○	●	●	○	●	—	6,0	±0,03	0,4	26,4	4,5	
N6008 MG	●	●	●	○	●	●	○	●	—	6,0	±0,03	0,8	26,4	4,5	
GCM N2002 ML	—	—	—	—	—	—	—	—	—	2,0	±0,03	0,2	21,1	3,6	
N3002 ML	●	●	●	○	●	●	○	●	—	3,0	±0,03	0,2	21,1	3,8	
N3004 ML	●	●	●	○	●	●	○	●	—	3,0	±0,03	0,4	21,1	3,8	
N4002 ML	●	●	●	○	●	●	○	●	—	4,0	±0,03	0,2	26,4	4,0	
N4004 ML	●	●	●	○	●	●	○	●	—	4,0	±0,03	0,4	26,4	4,0	
N4008 ML	●	●	●	○	●	●	○	●	—	4,0	±0,03	0,8	26,4	4,0	
N5004 ML	●	●	●	○	●	●	○	●	—	5,0	±0,03	0,4	26,4	4,1	
N5008 ML	●	●	●	○	●	●	○	●	—	5,0	±0,03	0,8	26,4	4,1	
N6004 ML	●	●	●	○	●	●	○	●	—	6,0	±0,03	0,4	26,4	4,5	
N6008 ML	●	●	●	○	●	●	○	●	—	6,0	±0,03	0,8	26,4	4,5	

### Grooving / Cut-Off Machining

Dimensions (mm)

Cat. No.	AC8035P	AC830P	AC5015S	AC5025S	AC520U	AC530U	T2500A	CW		RE	L	S	Fig.
								Cutting Width	Tolerance				
GCM N2002 GG	●	●	●	●	○	●	—	2,0	±0,03	0,2	21,1	3,6	1
N3002 GG	●	●	●	●	○	●	—	3,0	±0,03	0,2	21,1	3,8	
N3004 GG	●	●	●	●	○	●	—	3,0	±0,03	0,4	21,1	3,8	
N4002 GG	●	●	●	●	○	●	—	4,0	±0,03	0,2	26,4	4,0	
N4004 GG	●	●	●	●	○	●	—	4,0	±0,03	0,4	26,4	4,0	
N5002 GG	●	●	●	●	○	●	—	5,0	±0,03	0,2	26,4	4,1	
N5004 GG	●	●	●	●	○	●	—	5,0	±0,03	0,4	26,4	4,1	
N6002 GG	●	●	●	●	○	●	—	6,0	±0,03	0,2	26,4	4,5	
N6004 GG	●	●	●	●	○	●	—	6,0	±0,03	0,4	26,4	4,5	
GCM N2002 GL	●	●	●	●	○	●	—	2,0	±0,03	0,2	21,1	3,6	
N2004 GL	●	●	●	●	○	●	—	3,0	±0,03	0,4	21,1	3,6	
N3002 GL	●	●	●	●	○	●	—	3,0	±0,03	0,2	21,1	3,8	
N3004 GL	●	●	●	●	○	●	—	3,0	±0,03	0,4	21,1	3,8	
N4002 GL	●	●	●	●	○	●	—	4,0	±0,03	0,2	26,4	4,0	
N4004 GL	●	●	●	●	○	●	—	4,0	±0,03	0,4	26,4	4,0	
N5002 GL	●	●	●	●	○	●	—	5,0	±0,03	0,2	26,4	4,1	
N5004 GL	●	●	●	●	○	●	—	5,0	±0,03	0,4	26,4	4,1	
N6002 GL	●	●	●	●	○	●	—	6,0	±0,03	0,2	26,4	4,5	
N6004 GL	●	●	●	●	○	●	—	6,0	±0,03	0,4	26,4	4,5	
GCM N2002 GF	—	—	●	●	○	○	—	2,0	±0,03	0,2	21,1	3,6	1
N2004 GF	—	—	●	●	○	○	—	3,0	±0,03	0,4	21,1	3,6	
N3002 GF	●	●	●	●	○	○	—	3,0	±0,03	0,2	21,1	3,8	
N3004 GF	●	●	●	●	○	○	—	3,0	±0,03	0,4	21,1	3,8	
N4002 GF	●	●	●	●	○	○	—	4,0	±0,03	0,2	26,4	4,0	
N4004 GF	●	●	●	●	○	○	—	4,0	±0,03	0,4	26,4	4,0	
N5002 GF	●	●	●	●	○	○	—	5,0	±0,03	0,2	26,4	4,1	
N5004 GF	●	●	●	●	○	○	—	5,0	±0,03	0,4	26,4	4,1	
N6002 GF	●	●	●	●	○	○	—	6,0	±0,03	0,2	26,4	4,5	
N6004 GF	●	●	●	●	○	○	—	6,0	±0,03	0,4	26,4	4,5	

Combine the insert with a holder such that the width of cut (CW) matches.

### External Profiling / External Radius Grooving

Dimensions (mm)

Cat. No.	AC8025P	AC8035P	AC830P	AC425K	AC5015S	AC5025S	AC520U	AC530U	T2500A	CW		RE	L	S	Fig.
										Cutting Width	Tolerance				
GCM N3015 RG	●	●	●	●	●	●	○	●	○	3,0	±0,03	1,5	21,1	3,8	2
N4020 RG	●	●	●	●	●	●	○	●	○	4,0	±0,03	2,0	26,4	4,0	
N5025 RG	●	●	●	●	●	●	○	●	○	5,0	±0,03	2,5	27,2	4,1	
N6030 RG	●	●	●	●	●	●	○	●	○	6,0	±0,03	3,0	27,5	4,5	

### Profiling / Radius Grooving / Necking

Dimensions (mm)

Cat. No.	AC8025P	AC8035P	AC830P	AC425K	AC5015S	AC5025S	AC520U	AC530U	T2500A	CW		RE	L	S	Fig.
										Cutting Width	Tolerance				
GCM N2010 RN	—	—	—	—	●	●	○	○	—	2,0	±0,03	1,0	21,7	3,6	2
N3015 RN	●	●	●	○	●	●	○	○	—	3,0	±0,03	1,5	22,6	3,8	
N4020 RN	●	●	●	○	●	●	○	○	—	4,0	±0,03	2,0	28,2	4,0	
N5025 RN	●	●	●	○	●	●	○	○	—	5,0	±0,03	2,5	28,3	4,1	
N6030 RN	●	●	●	○	●	●	○	○	—	6,0	±0,03	3,0	28,3	4,5	

### Non-Ferrous Metals

Dimensions (mm)

Cat. No.	H1	CW		RE	L	S	Fig.
		Cutting Width	Tolerance				
GCG N2002 GA	○	2,0	±0,025	0,2	21,1	3,6	3
N3002 GA	○	3,0	±0,025	0,2	21,1	3,8	
N4004 GA	○	4,0	±0,025	0,4	26,4	4,0	
N5004 GA	○	5,0	±0,025	0,4	26,4	4,1	
N6004 GA	○	6,0	±0,025	0,4	26,4	4,5	



# Grooving Tool Holders GNDIS Type

## Internal Grooving

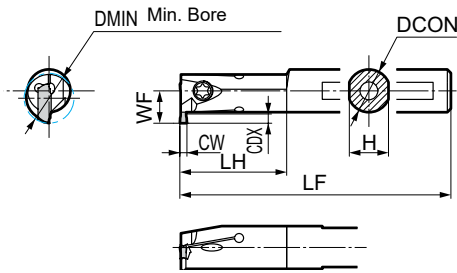
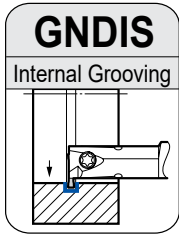

Above figures show right hand tools.

### ■ Spare Parts

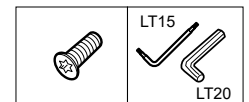

### ■ Holders

Cat. No.	Stock		Dimensions (mm)					Min. Bore (mm)	Groov. Width (mm)	Max. Groov. Depth (mm)	Applicable Insert	Cap Screw	Spanner
	R	L	DCON	H	LF	LH	WF						
GNDIS R/L 1214 T 1526	○	○	12	11	150	30	9,0	14	1,5	2,6	GXM N150005S GF		
GNDIS R/L 1214 T 1536	○	○	12	11	150	30	10,0	14	1,5	3,6	GXM N150005S GF	BFTX0409N	3,4 LT15
GNDIS R/L 1616 T 1536	○	○	16	15	160	35	11,5	16	1,5	3,6	GXM N150005S GF		
GNDIS R/L 1620 T 1546	○	○	16	15	160	40	14,5	20	1,5	4,6	GXM N150005S GF		
GNDIS R/L 2025 T 1566	○	○	20	19	180	40	19,0	25	1,5	6,6	GXM N150005S GF	BFTX0511N	5,0 LT20
GNDIS R/L 1214 T 2026	○	○	12	11	150	30	9,0	14	2,0	2,6	GXM N2002S-□□		
GNDIS R/L 1214 T 2036	○	○	12	11	150	30	10,0	14	2,0	3,6	GXM N2002S-□□	BFTX0409N	3,4 LT15
GNDIS R/L 1616 T 2036	○	○	16	15	160	35	11,5	16	2,0	3,6	GXM N2002S-□□		
GNDIS R/L 1620 T 2046	○	○	16	15	160	40	14,5	20	2,0	4,6	GXM N2002S-□□		
GNDIS R/L 2025 T 2066	○	○	20	19	180	40	19,0	25	2,0	6,6	GXM N2002S-□□	BFTX0511N	5,0 LT20
GNDIS R/L 1214 T 3026	○	○	12	11	150	30	9,0	14	3,0	2,6	GXM N3002S-□□		
GNDIS R/L 1214 T 3036	○	○	12	11	150	30	10,0	14	3,0	3,6	GXM N3002S-□□	BFTX0409N	3,4 LT15
GNDIS R/L 1616 T 3036	○	○	16	15	160	35	11,5	16	3,0	3,6	GXM N3002S-□□		
GNDIS R/L 1620 T 3046	○	○	16	15	160	40	14,5	20	3,0	4,6	GXM N3002S-□□		
GNDIS R/L 2025 T 3066	○	○	20	19	180	40	19,0	25	3,0	6,6	GXM N3002S-□□	BFTX0511N	5,0 LT20

Select holders and inserts with the same grooving width (CW).

Only GXM inserts can be used.

# Grooving Tool Holders GNDIS Type

## ■ Inserts for GNDIS

Coated Carbide

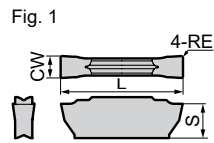

## ● Grooving / Traversing

Dimensions (mm)

Cat. No.	AC520U	AC1030U	CW		RE	L	S	Fig.
			Cutting Width	Tolerance				
GXM N2002S ML	○	○	2,0	±0,03	0,2	11,1	3,1	1
N3002S ML	○	○	3,0	±0,03	0,2	11,1	3,1	

Select holders and inserts with the same grooving width (CW).

## ● Grooving / Cut-Off Machining

Dimensions (mm)

Cat. No.	AC520U	AC1030U	CW		RE	L	S	Fig.
			Cutting Width	Tolerance				
GXM N150005S GF	○	○	1,5	±0,03	0,2	21,1	3,6	1
N2002S GF	○	○	2,0	±0,03	0,2	21,1	3,8	
N3002S GF	○	○	3,0	±0,03	0,4	21,1	3,8	

GCM and GCG inserts are not compatible.

## ■ Recommended Cutting Conditions

Work Material	P Carbon Steel / Alloy Steel		M Stainless Steel		K Cast Iron		S Exotic Alloy	
Grade	AC520U	AC1030U	AC520U	AC1030U	AC520U	AC1030U	AC520U	AC1030U
Cutting Speed (m/min)	80–200	50–200	70–150	50–150	60–200	50–200	20–80	20–60

## ■ Grooving / Cut-Off Machining / Necking

Chipbreaker		Feed Rate (mm/rev)	
		ML	GF
Width of Cut CW (mm)	1,5	–	0,02–0,10
	2,0	0,03–0,12	0,03–0,12
	3,0	0,05–0,15	0,05–0,15

## ■ Traversing

Chipbreaker		ML	
		Feed Rate (mm/rev)	Depth of Cut (mm)
Width of Cut CW (mm)	2,0	0,03–0,12	0,2–0,8
	3,0	0,05–0,15	0,3–1,2

# Grooving Tool Holders

## SSH Series



### ■ Features

Tough carbide body for stable machining.  
 Internal coolant supply for outstanding chip evacuation.  
 Adopts AC1030U for excellent machined surface quality.  
 In addition to grooving applications, we have a lineup of 12 items for circlip groove machining.

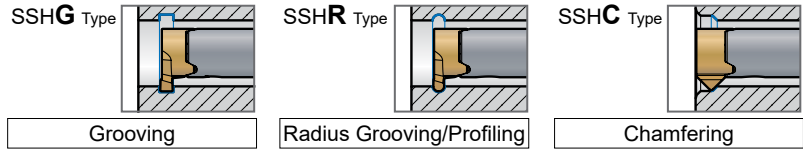

### ■ Application Range

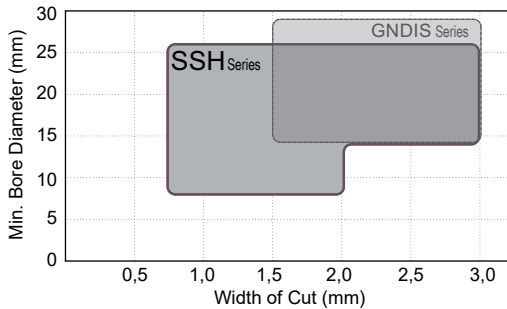

Width of Cut: 0,74 mm – 3,00 mm  
 Min. Bore Diameter: Ø 8,0 mm  
 Max. Groove Depth: to 4,0 mm  
 Holder: Carbide body (internal coolant supply)  
 Insert: Grade AC1030U



### ■ Chip Control



SSH Series

Stable and smooth evacuation of curled chips even on small diameters.

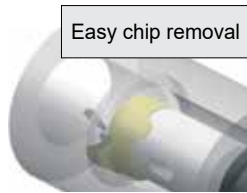

Easy chip removal



Competitor

Evacuation from grooves is poor, inviting sudden breakage.



No chip evacuation space

Work Material: C45      Cutting Conditions:  $v_c = 50$  m/min,  $f = 0,02$  mm/rev,  $a_p = 1,0$  mm, wet (oil-based)  
 Cutting Diameter: Ø 13 mm

### ■ Chatter Resistance

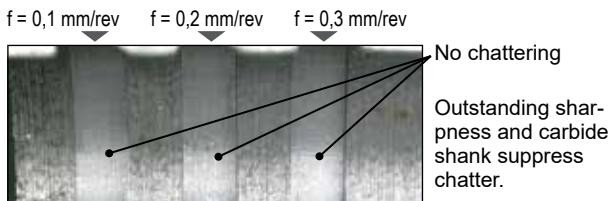

SSH Series

No chattering  
 Outstanding sharpness and carbide shank suppress chatter.

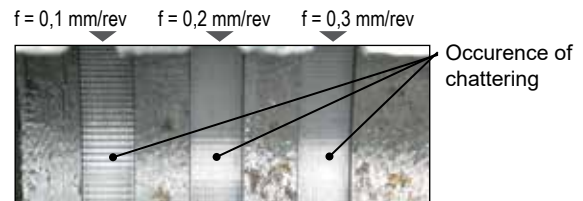

Competitor

Occurrence of chattering

Work Material: C45      Cutting Conditions:  $v_c = 100$  m/min,  $f = 0,01, 0,02, 0,03$  mm/rev,  $a_p = 0,2$  mm, wet (oil-based)  
 Cutting Diameter: Ø 13 mm

### ■ Machined Surface Quality

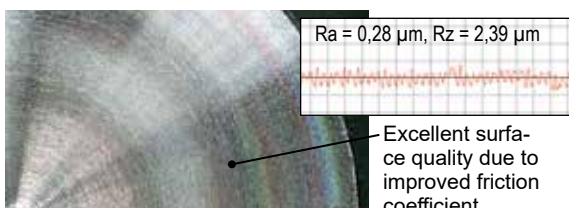

SSH Series

Excellent surface quality due to improved friction coefficient.

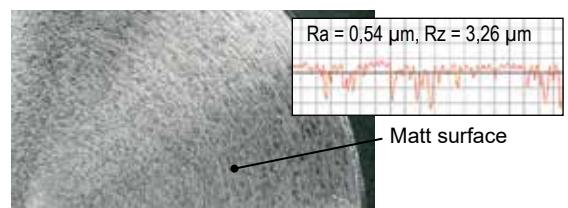

Competitor

Matt surface

Work Material: 42CrMo4      Cutting Conditions:  $v_c = 180$  m/min,  $f = 0,02$  mm/rev,  $a_p = 0,2$  mm, wet (oil-based)  
 Cutting Diameter: Ø 30 mm

# Grooving Tool Holders SSH Series

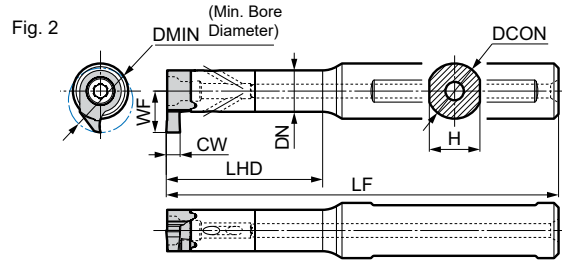
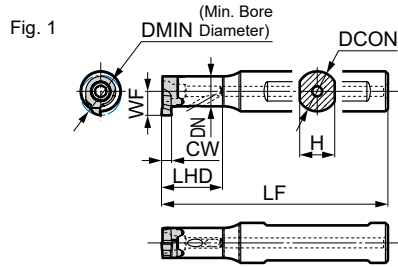

## Holder

Dimensions (mm)

## Parts

Cat. No.	Stock	DCON	DN	H	LF*	LHD	DMIN	CW	Fig.	Applicable Insert	Flat Screw	Wrench
												TRX08IP LT15IP
E08D SSHM N125 08	○	8	6	7	60	12,5	8	0,74-2,00	1	SSH_R/L 08 ...	BFTX02608IPS	TRX08IP
E08E SSHM N210 08	○	8	6	7	70	21,0	8	0,74-2,00	1			
E12E SSHM N125 08	○	12	6	11	70	12,5	8	0,74-2,00	1			
E12F SSHM N210 08	○	12	6	11	80	21,0	8	0,74-2,00	1			
E12G SSHM N300 08	○	12	6	11	90	30,0	8	0,74-2,00	1			
E12H SSHM N420 08	○	12	6	11	100	42,0	8	0,74-2,00	1	SSH_R/L 14 ...	BFTX0412IPS	LT15IP
E12X SSHM N195 14	○	12	9	11	75	19,5	14	0,74-3,00	2			
E12H SSHM N340 14	○	12	9	11	100	34,0	14	0,74-3,00	2			
E12J SSHM N450 14	○	12	9	11	110	45,0	14	0,74-3,00	2			
E12X SSHM N640 14	○	12	9	11	130	64,0	14	0,74-3,00	2			
E16F SSHM N195 14	○	16	9	14	80	19,5	14	0,74-3,00	2	SSH_R/L 14 ...	BFTX0412IPS	LT15IP
E16H SSHM N340 14	○	16	9	14	100	34,0	14	0,74-3,00	2			
E16J SSHM N450 14	○	16	9	14	110	45,0	14	0,74-3,00	2			
E16X SSHM N640 14	○	16	9	14	130	64,0	14	0,74-3,00	2			

\* The LF dimensions above are dimensions with SSHG/SSHR type insert mounted. Refer to the insert stock table for WF dimensions.

## Inserts (E08\_SSHM N\_\_\_-08 / E12\_SSHM N\_\_\_-08)

Dimensions (mm)

Applications	Cat. No.	AC1030U Coated Carbide		CW	CDX	RE	WF3	WF	S	E2	Fig.	Applicable Holder	Fig. 1 (For Grooving)
		R	L										
Grooving	SSHG R/L 0807400	○	○	0,74	1,0	-	3,2	4,80	3,6	0,4	1	E08_SSHM N___ 08 E12_SSHM N___ 08	   
	R/L 0808400	○	○	0,84	1,0	-	3,2	4,80	3,6	0,4	1		
	R/L 0809400	○	○	0,94	1,0	-	3,2	4,80	3,6	0,4	1		
	R/L 0810000	○	○	1,00	1,0	-	3,2	4,80	3,1	-	1		
	R/L 0810010	○	○	1,00	1,0	0,10	3,2	4,80	3,1	-	2		
	R/L 0811900	○	○	1,19	1,0	-	3,2	4,80	3,1	-	1		
	R/L 0813900	○	○	1,39	1,0	-	3,2	4,80	3,0	-	1		
	R/L 0815000	○	○	1,50	1,0	-	3,2	4,80	3,0	-	1		
	R/L 0815010	○	○	1,50	1,0	0,10	3,2	4,80	3,0	-	2		
	R/L 0816900	○	○	1,69	1,0	-	3,2	4,80	3,0	-	1		
Radius Grooving/ Profiling	R/L 0820000	○	○	2,00	1,0	-	3,2	4,80	3,0	-	1		
	R/L 0820010	○	○	2,00	1,0	0,10	3,2	4,80	3,0	-	2		
	R/L 0820020	○	○	2,00	1,0	0,20	3,2	4,80	3,0	-	2		
	SSHR R/L 08080	○	○	0,80	1,0	0,40	3,2	4,80	3,1	-	3		
	R/L 08100	○	○	1,00	1,0	0,50	3,2	4,80	3,1	-	3		
	R/L 08120	○	○	1,20	1,0	0,60	3,2	4,80	3,1	-	3		
Chamfering	R/L 08150	○	○	1,50	1,0	0,75	3,2	4,80	3,0	-	3		
	R/L 08180	○	○	1,80	1,0	0,90	3,2	4,80	3,0	-	3		
	R/L 08200	○	○	2,00	1,0	1,00	3,2	4,80	3,0	-	3		
	SSHC R/L 08454502	○	○	-	1,4	0,20	1,8	4,65	3,6	-	4		

\* Refer to the holder stock table for the DMIN dimensions above.

WF, WF3, E2: Cutting Edge Distance

Fig. shows right hand (R) tools.

# Grooving Tool Holders

## SSH Series



### Inserts (E12\_SSHM N\_\_\_-14 / E16\_SSHM N\_\_\_-14)

Dimensions (mm)

Applications	Cat. No.	AC1030U Coated Carbide		CW	CDX	RE	WF3	WF	S	E2	Fig.	Applicable Holder	Fig. 1 (For Grooving)
		R	L										
Grooving	SSHG R/L 1407400	○	○	0,74	1,2	-	5,3	9,0	5,5	0,2	1	E12_SSHM N___-14 E16_SSHM N___-14	<p>(Min. Bore Diameter)</p>
	R/L 1408400	○	○	0,84	1,3	-	5,3	9,0	5,5	0,2	1		
	R/L 1409400	○	○	0,94	1,5	-	5,3	9,0	5,5	0,2	1		<p>(Min. Bore Diameter)</p>
	R/L 1410000	○	○	1,00	1,6	-	5,3	9,0	5,5	0,2	1		
	R/L 1410010	○	○	1,00	1,6	0,10	5,3	9,0	5,5	0,2	2		<p>(Min. Bore Diameter)</p>
	R/L 1411900	○	○	1,19	4,0	-	5,3	9,0	5,2	-	1		
	R/L 1413900	○	○	1,39	4,0	-	5,3	9,0	5,1	-	1		<p>(Min. Bore Diameter)</p>
	R/L 1415000	○	○	1,50	4,0	-	5,3	9,0	5,1	-	1		
	R/L 1415010	○	○	1,50	4,0	0,10	5,3	9,0	5,1	-	2		<p>(Min. Bore Diameter)</p>
	R/L 1416900	○	○	1,69	4,0	-	5,3	9,0	5,1	-	1		
	R/L 1420000	○	○	2,00	4,0	-	5,3	9,0	5,1	-	1		<p>(Min. Bore Diameter)</p>
	R/L 1420010	○	○	2,00	4,0	0,10	5,3	9,0	5,1	-	2		
	R/L 1420020	○	○	2,00	4,0	0,20	5,3	9,0	5,1	-	2		<p>(Min. Bore Diameter)</p>
	R/L 1425000	○	○	2,50	4,0	-	5,3	9,0	5,1	-	1		
	R/L 1425010	○	○	2,50	4,0	0,10	5,3	9,0	5,1	-	2		<p>(Min. Bore Diameter)</p>
	R/L 1425020	○	○	2,50	4,0	0,20	5,3	9,0	5,1	-	2		
R/L 1430000	○	○	3,00	4,0	-	5,3	9,0	5,1	-	1	<p>(Min. Bore Diameter)</p>		
R/L 1430010	○	○	3,00	4,0	0,10	5,3	9,0	5,1	-	2		<p>(Min. Bore Diameter)</p>	
R/L 1430020	○	○	3,00	4,0	0,20	5,3	9,0	5,1	-	2	<p>(Min. Bore Diameter)</p>		
Radius Grooving/Profiling	SSHR R/L 14100	○	○	1,00	1,6	0,50	5,3	9,0	5,2	-		3	<p>(Min. Bore Diameter)</p>
	R/L 14120	○	○	1,20	4,0	0,60	5,3	9,0	5,2	-	3		
	R/L 14150	○	○	1,50	4,0	0,75	5,3	9,0	5,1	-	3		
	R/L 14180	○	○	1,80	4,0	0,90	5,3	9,0	5,1	-	3		
	R/L 14200	○	○	2,00	4,0	1,00	5,3	9,0	5,1	-	3		
	R/L 14220	○	○	2,20	4,0	1,10	5,3	9,0	5,1	-	3		
	R/L 14250	○	○	2,50	4,0	1,25	5,3	9,0	5,1	-	3		
	R/L 14300	○	○	3,00	4,0	1,50	5,3	9,0	5,1	-	3		

\* Refer to the holder stock table for the DMIN dimensions above.  
WF, WF3, E2: Cutting Edge Distance

○ = Japan stock

### Recommended Cutting Conditions

Work Material	<b>P</b> Carbon Steel/Alloy Steel	<b>M</b> Stainless Steel	<b>S</b> Cast Iron
Cutting Speed $v_c$ (m/min)	20-200	15-80	20-160
Feed Rate $f$ (mm/rev)	0,01-0,03	0,01-0,03	0,01-0,03

○ = Japan stock





# ISO-PSC Polygon Modular GND Grooving System

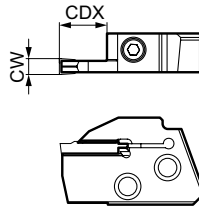
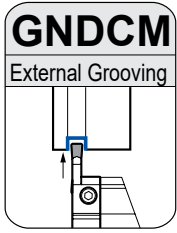

## General Features

New grades and chipbreakers have been added to the already established GND grooving system with polygon shank and a flexible and economical cassette system for inserts. An array of chipbreakers improves the efficiency in chip control in various applications such as grooving, turning, profiling and cut-off.

## Advantages

- GND inserts for soft grooving from 2,0 - 6,0 mm width
- Expanded grade selection with 9 different chipbreakers for a wide application range
- Provides excellent chip control
- Achieves stable long tool life

## Cassette

Cat. No.	R	L	CW (mm)	CDX (mm)	Inserts	Cap Screw	Tightening Torque (N·m)	Spanner
GND MCM R/L 212	●	●	2	12	GCM □2000-□□	BX0512	5,0	LH040
GND MCM R/L 312	●	●	3		GCM □3000-□□			
GND MCM R/L 418	●	●	4	GCM □4000-□□				
GND MCM R/L 518	●	●	5	GCM □5000-□□				
GND MCM R/L 618	●	●	6	GCM □6000-□□				
				GCM □6000-□□				

## Handling

### ATTENTION

To fix the cassette on the holder, please clamp the cassette at first with the inner torx screw.

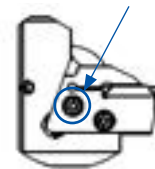

## Holder

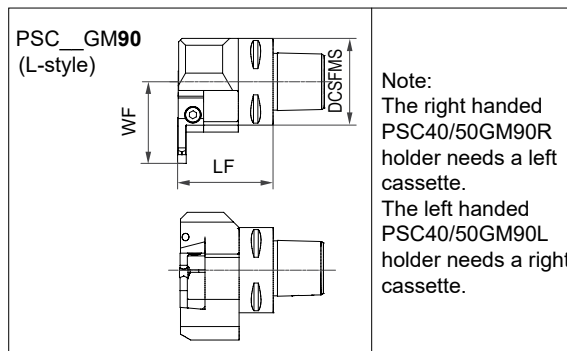
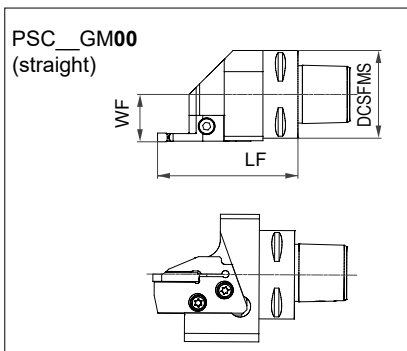

Note:  
The right handed PSC40/50GM90R holder needs a left cassette.  
The left handed PSC40/50GM90L holder needs a right cassette.

Style	Cat. No.	R	L	DCSFMS (mm)	WF (mm)	LF (mm)	Cap Screw	Tightening Torque (N·m)	Spanner
Straight	PSC40GM00 R/L	●	●	40	22	80*	BFTX0619N	7,5	LT25
	PSC50GM00 R/L	●	●	50	27				
L-Style	PSC40GM90 R/L	●	●	40	42*	52,5			
	PSC50GM90 R/L	●	●	50	47*	55,0			

\* Dimension when using radial grooving cassettes.

## Identification Details - Polygon-Toolholder

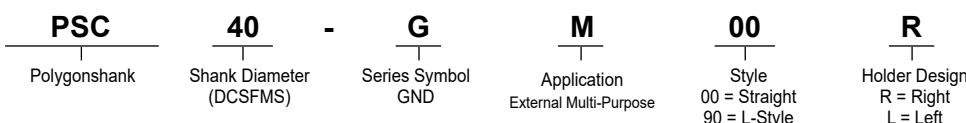

## Identification Details - Cassette

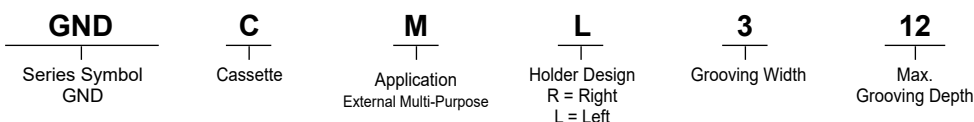

## Inserts for GNDCM

Coated Carbide    Cermet    Carbide

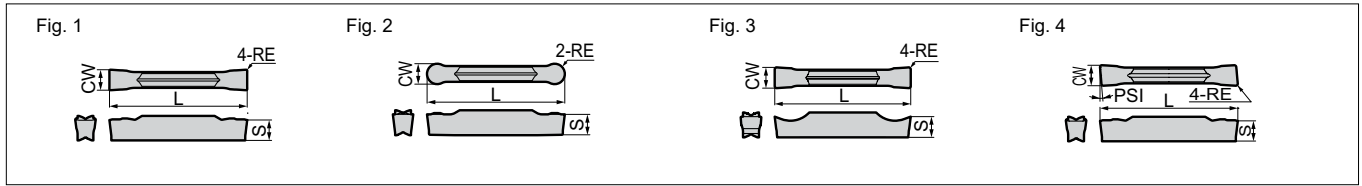

### Grooving / Traversing

Dimensions (mm)

Cat. No.	AC8025P	AC8035P	AC830P	AC425K	AC5015S	AC5025S	AC520U	AC530U	T2500A	CW		RE	L	S	Fig.
										Cutting Width	Tolerance				
GCM N3002 MG	●	●	●	○	●	●	○	●	—	3,0	±0.03	0,2	21,1	3,8	1
N3004 MG	●	●	●	○	●	●	○	●	—	3,0	±0.03	0,4	21,1	3,8	
N4002 MG	●	●	●	○	●	●	○	●	—	4,0	±0.03	0,2	26,4	4,0	
N4004 MG	●	●	●	○	●	●	○	●	—	4,0	±0.03	0,4	26,4	4,0	
N4008 MG	●	●	●	○	●	●	○	●	—	4,0	±0.03	0,8	26,4	4,0	
N5004 MG	●	●	●	○	●	●	○	●	—	5,0	±0.03	0,4	26,4	4,1	
N5008 MG	●	●	●	○	●	●	○	●	—	5,0	±0.03	0,8	26,4	4,1	
N6004 MG	●	●	●	○	●	●	○	●	—	6,0	±0.03	0,4	26,4	4,5	
N6008 MG	●	●	●	○	●	●	○	●	—	6,0	±0.03	0,8	26,4	4,5	
GCM N2002 ML	—	—	—	—	●	●	○	○	—	2,0	±0.03	0,2	21,1	3,6	1
N3002 ML	●	●	●	○	●	●	○	●	—	3,0	±0.03	0,2	21,1	3,8	
N3004 ML	●	●	●	○	●	●	○	●	—	3,0	±0.03	0,4	21,1	3,8	
N4002 ML	●	●	●	○	●	●	○	●	—	4,0	±0.03	0,2	26,4	4,0	
N4004 ML	●	●	●	○	●	●	○	●	—	4,0	±0.03	0,4	26,4	4,0	
N4008 ML	●	●	●	○	●	●	○	●	—	4,0	±0.03	0,8	26,4	4,0	
N5004 ML	●	●	●	○	●	●	○	●	—	5,0	±0.03	0,4	26,4	4,1	
N5008 ML	●	●	●	○	●	●	○	●	—	5,0	±0.03	0,8	26,4	4,1	
N6004 ML	●	●	●	○	●	●	○	●	—	6,0	±0.03	0,4	26,4	4,5	
N6008 ML	●	●	●	○	●	●	○	●	—	6,0	±0.03	0,8	26,4	4,5	

### Grooving / Cut-Off Machining

Dimensions (mm)

Cat. No.	AC8035P	AC830P	AC5015S	AC5025S	AC520U	AC530U	T2500A	CW		RE	L	S	Fig.
								Cutting Width	Tolerance				
GCM N2002 GG	●	●	●	●	○	○	—	2,0	±0.03	0,2	21,1	3,6	1
N3002 GG	●	●	●	●	○	○	—	3,0	±0.03	0,2	21,1	3,8	
N3004 GG	●	●	●	●	○	○	—	3,0	±0.03	0,4	21,1	3,8	
N4002 GG	●	●	●	●	○	○	—	4,0	±0.03	0,2	26,4	4,0	
N4004 GG	●	●	●	●	○	○	—	4,0	±0.03	0,4	26,4	4,0	
N5002 GG	●	●	●	●	○	○	—	5,0	±0.03	0,2	26,4	4,1	
N5004 GG	●	●	●	●	○	○	—	5,0	±0.03	0,4	26,4	4,1	
N6002 GG	●	●	●	●	○	○	—	6,0	±0.03	0,2	26,4	4,5	
N6004 GG	●	●	●	●	○	○	—	6,0	±0.03	0,4	26,4	4,5	
GCM N2002 GL	●	●	●	●	○	○	—	2,0	±0.03	0,2	21,1	3,6	1
N2004 GL	●	●	●	●	○	○	—	2,0	±0.03	0,4	21,1	3,6	
N3002 GL	●	●	●	●	○	○	—	3,0	±0.03	0,2	21,1	3,8	
N3004 GL	●	●	●	●	○	○	—	3,0	±0.03	0,4	21,1	3,8	
N4002 GL	●	●	●	●	○	○	—	4,0	±0.03	0,2	26,4	4,0	
N4004 GL	●	●	●	●	○	○	—	4,0	±0.03	0,4	26,4	4,0	
N5002 GL	●	●	●	●	○	○	—	5,0	±0.03	0,2	26,4	4,1	
N5004 GL	●	●	●	●	○	○	—	5,0	±0.03	0,4	26,4	4,1	
N6002 GL	●	●	●	●	○	○	—	6,0	±0.03	0,2	26,4	4,5	
N6004 GL	●	●	●	●	○	○	—	6,0	±0.03	0,4	26,4	4,5	
GCM N2002 GF	—	—	●	●	○	○	—	2,0	±0.03	0,2	21,1	3,6	1
N2004 GF	—	—	●	●	○	○	—	2,0	±0.03	0,4	21,1	3,6	
N3002 GF	●	●	●	●	○	○	—	3,0	±0.03	0,2	21,1	3,8	
N3004 GF	●	●	●	●	○	○	—	3,0	±0.03	0,4	21,1	3,8	
N4002 GF	●	●	●	●	○	○	—	4,0	±0.03	0,2	26,4	4,0	
N4004 GF	●	●	●	●	○	○	—	4,0	±0.03	0,4	26,4	4,0	
N5002 GF	●	●	●	●	○	○	—	5,0	±0.03	0,2	26,4	4,1	
N5004 GF	●	●	●	●	○	○	—	5,0	±0.03	0,4	26,4	4,1	
N6002 GF	●	●	●	●	○	○	—	6,0	±0.03	0,2	26,4	4,5	
N6004 GF	●	●	●	●	○	○	—	6,0	±0.03	0,4	26,4	4,5	

### External Profiling / External Radius Grooving

Dimensions (mm)

Cat. No.	AC8025P	AC8035P	AC830P	AC425K	AC5015S	AC5025S	AC520U	AC530U	T2500A	CW		RE	L	S	Fig.
										Cutting Width	Tolerance				
GCM N3015 RG	●	●	●	●	●	○	○	●	—	3,0	±0.03	1,5	21,1	3,8	2
N4020 RG	●	●	●	●	●	○	○	●	—	4,0	±0.03	2,0	26,4	4,0	
N5025 RG	●	●	●	●	●	○	○	●	—	5,0	±0.03	2,5	27,2	4,1	
N6030 RG	●	●	●	●	●	○	○	●	—	6,0	±0.03	3,0	27,5	4,5	

### Cut-Off Machining (Handed Edge)

Dimensions (mm)

Cat. No.	AC8035P	AC830P	AC5015S	AC5025S	AC520U	AC530U	AC1030U	PSI	CW		RE	L	S	Fig.
									Cutting Width	Tolerance				
GCM R2002 CG 05	●	●	●	●	○	○	—	5°	2,0	±0.03	0,2	21,1	3,6	4
L2002 CG 05	●	●	●	●	○	○	—	5°	2,0	±0.03	0,2	21,1	3,6	
GCM R3002 CG 05	●	●	●	●	○	○	—	5°	3,0	±0.03	0,2	21,3	3,8	
L3002 CG 05	●	●	●	●	○	○	—	5°	3,0	±0.03	0,2	21,3	3,8	
GCM R4002 CG 05	●	●	●	●	○	○	—	5°	4,0	±0.04	0,2	26,7	4,0	
L4002 CG 05	●	●	●	●	○	○	—	5°	4,0	±0.04	0,2	26,7	4,0	
GCM R2003 CF 10	—	—	●	●	—	—	●	10°	2,0	±0.08	0,03	22,4	3,6	
L2003 CF 10	—	—	●	●	—	—	●	10°	2,0	±0.08	0,03	22,4	3,6	
GCM R3003 CF 10	—	—	●	●	—	—	●	10°	3,0	±0.08	0,03	22,4	3,8	
L3003 CF 10	—	—	●	●	—	—	●	10°	3,0	±0.08	0,03	22,4	3,8	
GCM R2003 CF 15	—	—	●	●	—	—	●	15°	2,0	±0.08	0,03	22,4	3,6	
L2003 CF 15	—	—	●	●	—	—	●	15°	2,0	±0.08	0,03	22,4	3,6	
GCM R3003 CF 15	—	—	●	●	—	—	●	15°	3,0	±0.08	0,03	22,4	3,8	
L3003 CF 15	—	—	●	●	—	—	●	15°	3,0	±0.08	0,03	22,4	3,8	

GCM R: Right hand    GCM L: Left hand  
Combine the insert with a holder such that the width of cut (CW) matches.

### Profiling / Radius Grooving / Necking

Dimensions (mm)

Cat. No.	AC8025P	AC8035P	AC830P	AC425K	AC5015S	AC5025S	AC520U	AC530U	T2500A	CW		RE	L	S	Fig.
										Cutting Width	Tolerance				
GCM N2010 RN	—	—	—	—	●	●	○	○	—	2,0	±0.03	1,0	21,7	3,6	2
N3015 RN	●	●	●	○	●	●	○	○	—	3,0	±0.03	1,5	22,6	3,8	
N4020 RN	●	●	●	○	●	●	○	○	—	4,0	±0.03	2,0	28,2	4,0	
N5025 RN	●	●	●	○	●	●	○	○	—	5,0	±0.03	2,5	28,3	4,1	
N6030 RN	●	●	●	○	●	●	○	○	—	6,0	±0.03	3,0	28,3	4,5	

### Non-Ferrous Metals

Dimensions (mm)

Cat. No.	H1	CW		RE	L	S	Fig.
		Cutting Width	Tolerance				
GCG N2002 GA	○	2,0	±0.025	0,2	21,1	3,6	3
N3002 GA	○	3,0	±0.025	0,2	21,1	3,8	
N4004 GA	○	4,0	±0.025	0,4	26,4	4,0	
N5004 GA	○	5,0	±0.025	0,4	26,4	4,1	
N6004 GA	○	6,0	±0.025	0,4	26,4	4,5	

# ISO-PSC Polygon Modular GND Grooving System

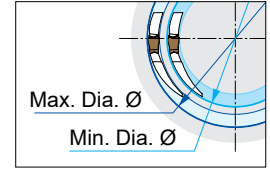
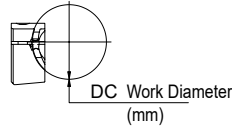
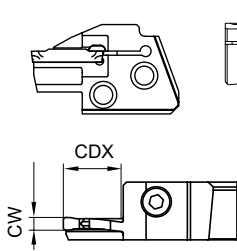
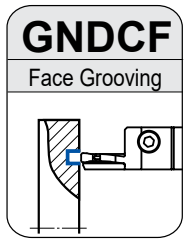

Work diameters in the stock indicate external diameters of face grooving.

Above figures show right hand tools.

## ■ Cassette

Cat. No.	R	L	CW (mm)	Diameter Range (mm)	DC (mm)	CDX (mm)	Inserts	Cap Screw	Tightening Torque (N·m)	Spanner		
GNDCF R/L 312-040	●	●	3	40-200	40-55	12	GC□ N3000-□□	BX0512	5,0 <sup>Nm</sup>	LH040		
GNDCF R/L 315-050	●	●			50-70	15						
GNDCF R/L 315-065	●	●			65-100	15						
GNDCF R/L 318-090	●	□			90-150	18						
GNDCF R/L 318-140	●	□			140-200	18						
GNDCF R/L 418-040	●	●	4	40-300	40-55	18	GC□ N4000-□□		BX0512		6,0 <sup>Nm</sup>	LH040
GNDCF R/L 418-050	●	□			50-70	18						
GNDCF R/L 418-065	●	●			65-90	18						
GNDCF R/L 418-085	●	□			85-130	18						
GNDCF R/L 418-125	□	□			125-200	18						
GNDCF R/L 418-180	●	□	180-300	18								
GNDCF R/L 518-050	□	□	5	50-300	50-70	18	GC□ N5000-□□	BX0512		6,0 <sup>Nm</sup>	LH040	
GNDCF R/L 518-065	□	□			65-90	18						
GNDCF R/L 518-085	□	□			85-130	18						
GNDCF R/L 518-125	●	□			125-200	18						
GNDCF R/L 518-180	□	□			180-300	18						
GNDCF R/L 618-050	□	□	6	50-1000	50-75	18	GC□ N6000-□□		BX0512	6,0 <sup>Nm</sup>		LH040
GNDCF R/L 618-070	□	□			70-110	18						
GNDCF R/L 618-100	□	□			100-200	18						
GNDCF R/L 618-180	□	□			180-300	18						
GNDCF R/L 618-280	□	□			280-1000	18						

## ■ Holder

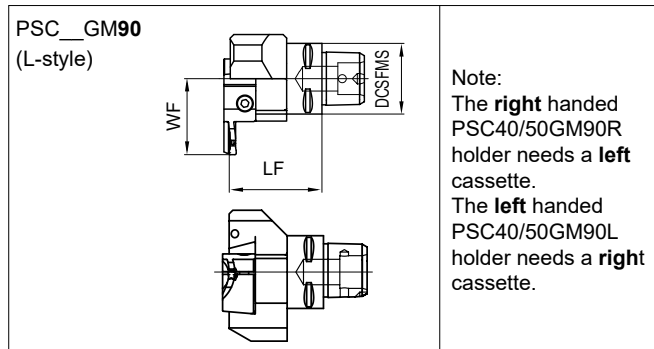
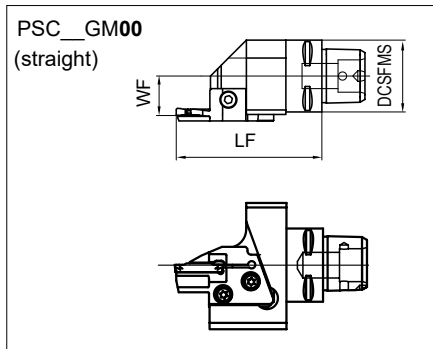

Note:  
The **right** handed PSC40/50GM90R holder needs a **left** cassette.  
The **left** handed PSC40/50GM90L holder needs a **right** cassette.

Style	Cat. No.	R	L	DCSFMS (mm)	WF (mm)	LF (mm)	Cap Screw	Tightening Torque (N·m)	Spanner
Straight	PSC40GM00 R/L	●	●	40	22	81*	BFTX0619N	7,5 <sup>Nm</sup>	LT25
	PSC50GM00 R/L	●	●	50	27				
L-Style	PSC40GM90 R/L	●	●	40	43*	52,5			
	PSC50GM90 R/L	●	●	50	48*	55,0			

\* Dimension when using face grooving cassettes.

## ■ Identification Details - Polygon-Toolholder

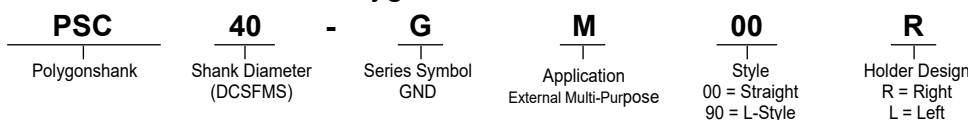

## ■ Identification Details - Cassette

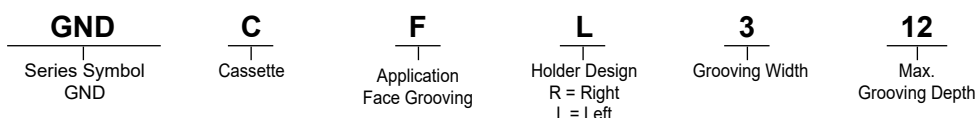

## Inserts for GNDCF

Coated Carbide    Cermet    Carbide

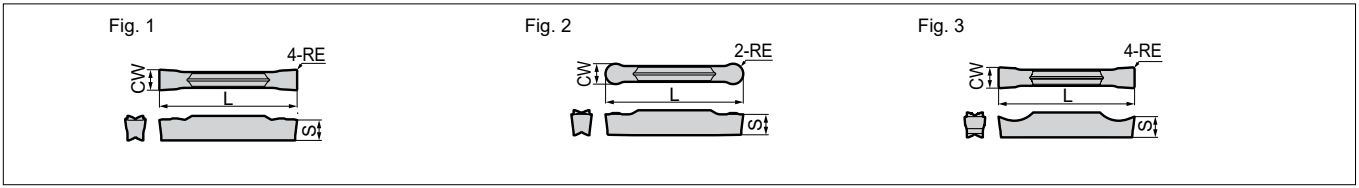

### Grooving / Traversing

Dimensions (mm)

Cat. No.	AC8025P	AC8035P	AC830P	AC425K	AC5015S	AC5025S	AC520U	AC530U	T2500A	CW		RE	L	S	Fig.
										Cutting Width	Tolerance				
GCM N3002 MG	●	●	●	○	●	●	○	●	—	3,0	±0.03	0,2	21,1	3,8	1
N3004 MG	●	●	●	○	●	●	○	●	—	3,0	±0.03	0,4	21,1	3,8	
N4002 MG	●	●	●	○	●	●	○	●	—	4,0	±0.03	0,2	26,4	4,0	
N4004 MG	●	●	●	○	●	●	○	●	—	4,0	±0.03	0,4	26,4	4,0	
N4008 MG	●	●	●	○	●	●	○	●	—	4,0	±0.03	0,8	26,4	4,0	
N5004 MG	●	●	●	○	●	●	○	●	—	5,0	±0.03	0,4	26,4	4,1	
N5008 MG	●	●	●	○	●	●	○	●	—	5,0	±0.03	0,8	26,4	4,1	
N6004 MG	●	●	●	○	●	●	○	●	—	6,0	±0.03	0,4	26,4	4,5	
N6008 MG	●	●	●	○	●	●	○	●	—	6,0	±0.03	0,8	26,4	4,5	
GCM N3002 ML	●	●	●	○	●	●	○	●	○	3,0	±0.03	0,2	21,1	3,8	1
N3004 ML	●	●	●	○	●	●	○	●	○	3,0	±0.03	0,4	21,1	3,8	
N4002 ML	●	●	●	○	●	●	○	●	○	4,0	±0.03	0,2	26,4	4,0	
N4004 ML	●	●	●	○	●	●	○	●	○	4,0	±0.03	0,4	26,4	4,0	
N4008 ML	●	●	●	○	●	●	○	●	○	4,0	±0.03	0,8	26,4	4,0	
N5004 ML	●	●	●	○	●	●	○	●	○	5,0	±0.03	0,4	26,4	4,1	
N5008 ML	●	●	●	○	●	●	○	●	○	5,0	±0.03	0,8	26,4	4,1	
N6004 ML	●	●	●	○	●	●	○	●	○	6,0	±0.03	0,4	26,4	4,5	
N6008 ML	●	●	●	○	●	●	○	●	○	6,0	±0.03	0,8	26,4	4,5	

### Grooving / Cut-Off Machining

Dimensions (mm)

Cat. No.	AC8035P	AC830P	AC5015S	AC5025S	AC520U	AC530U	T2500A	CW		RE	L	S	Fig.
								Cutting Width	Tolerance				
GCM N3002 GG	●	●	●	●	○	●	—	3,0	±0.03	0,2	21,1	3,8	1
N3004 GG	●	●	●	●	○	●	—	3,0	±0.03	0,4	21,1	3,8	
N4002 GG	●	●	●	●	○	●	—	4,0	±0.03	0,2	26,4	4,0	
N4004 GG	●	●	●	●	○	●	—	4,0	±0.03	0,4	26,4	4,0	
N5002 GG	●	●	●	●	○	●	—	5,0	±0.03	0,2	26,4	4,1	
N5004 GG	●	●	●	●	○	●	—	5,0	±0.03	0,4	26,4	4,1	
N6002 GG	●	●	●	●	○	●	—	6,0	±0.03	0,2	26,4	4,5	
N6004 GG	●	●	●	●	○	●	—	6,0	±0.03	0,4	26,4	4,5	
GCM N3002 GL	●	●	●	●	○	●	○	3,0	±0.03	0,2	21,1	3,8	1
N3004 GL	●	●	●	●	○	●	○	3,0	±0.03	0,4	21,1	3,8	
N4002 GL	●	●	●	●	○	●	○	4,0	±0.03	0,2	26,4	4,0	
N4004 GL	●	●	●	●	○	●	○	4,0	±0.03	0,4	26,4	4,0	
N5002 GL	●	●	●	●	○	●	○	5,0	±0.03	0,2	26,4	4,1	
N5004 GL	●	●	●	●	○	●	○	5,0	±0.03	0,4	26,4	4,1	
N6002 GL	●	●	●	●	○	●	○	6,0	±0.03	0,2	26,4	4,5	
N6004 GL	●	●	●	●	○	●	○	6,0	±0.03	0,4	26,4	4,5	
GCM N3002 GF	●	●	●	●	○	●	○	3,0	±0.03	0,2	21,1	3,8	1
N3004 GF	●	●	●	●	○	●	○	3,0	±0.03	0,4	21,1	3,8	
N4002 GF	●	●	●	●	○	●	○	4,0	±0.03	0,2	26,4	4,0	
N4004 GF	●	●	●	●	○	●	○	4,0	±0.03	0,4	26,4	4,0	
N5002 GF	●	●	●	●	○	●	○	5,0	±0.03	0,2	26,4	4,1	
N5004 GF	●	●	●	●	○	●	○	5,0	±0.03	0,4	26,4	4,1	
N6002 GF	●	●	●	●	○	●	○	6,0	±0.03	0,2	26,4	4,5	
N6004 GF	●	●	●	●	○	●	○	6,0	±0.03	0,4	26,4	4,5	

Combine the insert with a holder such that the width of cut (CW) matches.

### Profiling / Radius Grooving / Necking

Dimensions (mm)

Cat. No.	AC8025P	AC8035P	AC830P	AC425K	AC5015S	AC5025S	AC520U	AC530U	T2500A	CW		RE	L	S	Fig.
										Cutting Width	Tolerance				
GCM N3015 RN	●	●	●	○	●	●	○	●	—	3,0	±0.03	1,5	22,6	3,8	2
N4020 RN	●	●	●	○	●	●	○	●	—	4,0	±0.03	2,0	28,2	4,0	
N5025 RN	●	●	●	○	●	●	○	●	—	5,0	±0.03	2,5	28,3	4,1	
N6030 RN	●	●	●	○	●	●	○	●	—	6,0	±0.03	3,0	28,3	4,5	

### Non-Ferrous Metals

Dimensions (mm)

Cat. No.	H1	CW		RE	L	S	Fig.
		Cutting Width	Tolerance				
GCM N3002 GA	○	3,0	±0.025	0,2	21,1	3,8	3
N4004 GA	○	4,0	±0.025	0,4	26,4	4,0	
N5004 GA	○	5,0	±0.025	0,4	26,4	4,1	
N6004 GA	○	6,0	±0.025	0,4	26,4	4,5	

# SumiTurn B-Groove Insert TGA-BF Type



## Characteristics

- Outstanding chip control when grooving
- Excellent chip control when finishing wide grooves using axial feed
- Grooving inserts from 1,5–4,5 mm wide
- Grade AC530U with Super ZX ultra hard coating for steels, stainless steels and cast iron increases productivity and extends tool life

## External Grooving

Figures show right hand tools.

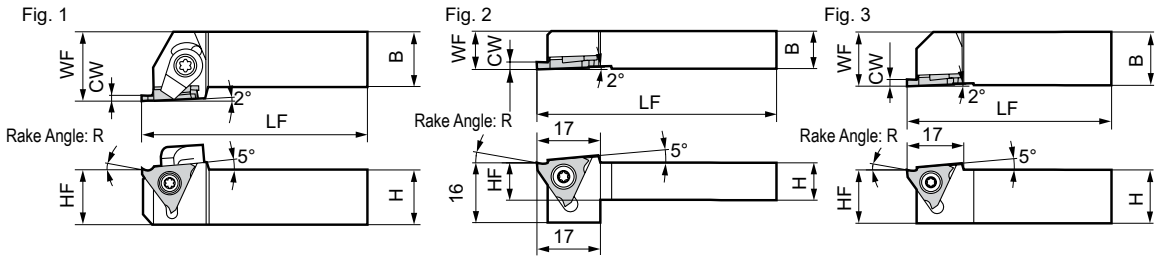
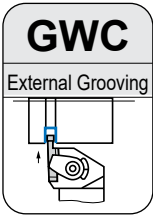

The rake angle R varies depending on the insert grade. For details, see the table at the lower part of page F47.

## Spare Parts

Screw	Wrench	Clamp	Screw	Wrench
BFTX 0409N	3,4 TRX15	-	-	-
BFTX 0409N	3,4 TRX15	CCM 6B -L/R	WB 6-20 -T/TL	5,0 LT20
BFTX 0511N	5,0 TRX20	CCM 8U -L/R	WB 8-22 -T/TL	5,0 LT27

## Holdings

Right handed tool holders are applicable with **right** handed inserts (TGA-R), left handed clamp plates (CCM\_\_L) and right handed screws 8WB\_\_T)

Cat. No.	Stock		Dimensions (mm)					Fig.	Grooving Width CW (mm)	Maximum Grooving Depth (mm)	Applicable Insert Group No.	Screw	Wrench	Clamp	Screw	Wrench		
	R	L	H	B	LF	WF	HF											
GWC R/L 1010-3	○	○	10	10	125	10	10	2	0,33–2,80	0,8–2,5	①	BFTX 0409N	3,4	TRX15	-	-	-	
GWC R/L 1212-3	○	○	12	12	125	12	12	2	0,33–2,80	0,8–2,5	①	BFTX 0409N	3,4	TRX15	-	-	-	
GWC R/L 1616-3	●	○	16	16	125	16	16	3	0,33–2,80	0,8–2,5	①	BFTX 0409N	3,4	TRX15	CCM 6B -L/R	WB 6-20 -T/TL	5,0	LT20
GWC R/L 2020-3	○	○	20	20	125	20	20	1	0,33–2,80	0,8–2,5	①	BFTX 0409N	3,4	TRX15	CCM 6B -L/R	WB 6-20 -T/TL	5,0	LT20
GWC R/L 2525-3	○	●	25	20	150	30	25	1	0,33–2,80	0,8–2,5	①	BFTX 0409N	3,4	TRX15	CCM 6B -L/R	WB 6-20 -T/TL	5,0	LT20
GWC R/L 2020-15	●	●	20	20	125	25	20	1	1,25–1,45	2,0	②	BFTX 0511N	5,0	TRX20	CCM 8U -L/R	WB 8-22 -T/TL	5,0	LT27
GWC R/L 2020-25	●	○	20	20	125	25	20	1	1,50–2,30	3,5	③	BFTX 0511N	5,0	TRX20	CCM 8U -L/R	WB 8-22 -T/TL	5,0	LT27
GWC R/L 2020-35	●	○	20	20	125	25	20	1	2,50–4,80	5,0	④	BFTX 0511N	5,0	TRX20	CCM 8U -L/R	WB 8-22 -T/TL	5,0	LT27
GWC R/L 2525-15	●	○	25	25	150	30	25	1	1,25–1,45	2,0	②	BFTX 0511N	5,0	TRX20	CCM 8U -L/R	WB 8-22 -T/TL	5,0	LT27
GWC R/L 2525-25	●	●	25	25	150	30	25	1	1,50–2,30	3,5	③	BFTX 0511N	5,0	TRX20	CCM 8U -L/R	WB 8-22 -T/TL	5,0	LT27
GWC R/L 2525-35	●	●	25	25	150	30	25	1	2,50–4,80	5,0	④	BFTX 0511N	5,0	TRX20	CCM 8U -L/R	WB 8-22 -T/TL	5,0	LT27

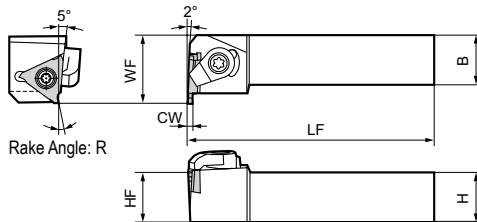
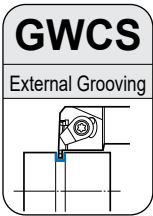

The rake angle R varies depending on the insert grade. For details, see the table at the lower part of page F47.

Figures show right hand tools.

## Spare Parts

Screw	Wrench	Clamp	Screw	Wrench
BFTX 0409N	3,4 TRX15	CCM 6B -L/R	WB 6-20 -T/TL	5,0 LT20
BFTX 0511N	5,0 TRX20	CCM 8U -L/R	WB 8-22 -T/TL	5,0 LT27

## Holdings

Right handed tool holders are applicable with **left** handed inserts (TGA-L), right handed clamp plates (CCM\_\_R) and left handed screws (WB\_\_TL)

Cat. No.	Stock		Dimensions (mm)					Fig.	Grooving Width CW (mm)	Maximum Grooving Depth (mm)	Applicable Insert Group No.	Screw	Wrench	Clamp	Screw	Wrench		
	R	L	H	B	LF	WF	HF											
GWCS R/L 2020-3	○		20	20	125	25	20		0,33–2,80	0,8–2,5	①	BFTX 0409N	3,4	TRX15	CCM 6B -L/R	WB 6-20 -T/TL	5,0	LT20
GWCS R/L 2525-3			25	25	150	30	25		0,33–2,80	0,8–2,5	①	BFTX 0409N	3,4	TRX15	CCM 6B -L/R	WB 6-20 -T/TL	5,0	LT20
GWCS R/L 2020-15	○	○	20	20	125	27	20		1,25–1,45	2,0	②	BFTX 0511N	5,0	TRX20	CCM 8U -L/R	WB 8-22 -T/TL	5,0	LT27
GWCS R/L 2020-25	○	○	20	20	125	27	20		1,50–2,30	3,5	③	BFTX 0511N	5,0	TRX20	CCM 8U -L/R	WB 8-22 -T/TL	5,0	LT27
GWCS R/L 2020-35	○	○	20	20	125	27	20		2,50–4,80	5,0	④	BFTX 0511N	5,0	TRX20	CCM 8U -L/R	WB 8-22 -T/TL	5,0	LT27
GWCS R/L 2525-15	○	○	25	25	150	32	25		1,25–1,45	2,0	②	BFTX 0511N	5,0	TRX20	CCM 8U -L/R	WB 8-22 -T/TL	5,0	LT27
GWCS R/L 2525-25	○	○	25	25	150	32	25		1,50–2,30	3,5	③	BFTX 0511N	5,0	TRX20	CCM 8U -L/R	WB 8-22 -T/TL	5,0	LT27
GWCS R/L 2525-35	○	○	25	25	150	32	25		2,50–4,80	5,0	④	BFTX 0511N	5,0	TRX20	CCM 8U -L/R	WB 8-22 -T/TL	5,0	LT27



### ISO-PSC Polygon Modular



#### Holder

Cat. No.	R	L	Ø (mm)	F (mm)	L (mm)	Cap Screw	$\omega$	Spanner
PSC 40 GM00 R/L	●	●	40	22	80,0	BFTX0619N	7,5	LT25
PSC 50 GM00 R/L	●	●	50	27	80,0			
PSC 40 GM90 R/L	●	●	40	42	52,5			
PSC 50 GM90 R/L	●	●	50	47	55,0			

#### Cassette

Cat. No.	R	L	Grooving Width (mm)	Grooving Depth (mm)	Insert	Insert Screw	Spanner	Spring	Clamp Finger	Cap Screw	$\omega$	Spanner
GWCCM R/L 25	●	●	1,5-2,3	3,9	TGA□4□□□BF	BFTX0511N	TRX20		SCP4A		3,0	LH030
GWCCM R/L 35	●	●	2,5-4,5	5,4	TGA□4□□□BF	5,0 $\omega$						

### Internal Grooving

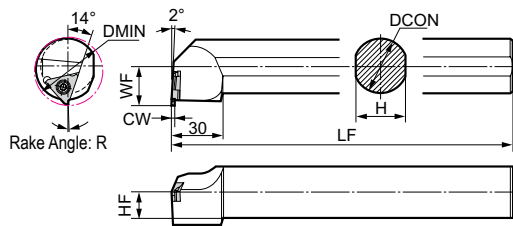
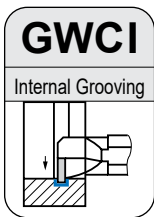

The rake angle R varies depending on the insert grade. For details, see the table at the lower part of page F39.

Figures show right hand tools.

#### Spare Parts



#### Holder

Right handed tool holders are applicable with left handed inserts (TGA-L).

Cat. No.	Stock		Dimensions (mm)						Grooving width CW (mm)	Maximum Grooving Depth (mm)	Applicable Insert Group No.	Screw	$\omega$	Wrench
	R	L	DMIN	DCON	LF	H	HF	WF						
GWCI R/L 325	○	○	35	25	100	23	11,5	17,5	0,33-2,80	0,8-2,0	①	BFTX0409N	3,4	TRX 15
GWCI R/L 432	○	○	40	32	250	30	15,0	17,5	1,25-4,80	2,0-2,5	②③④	BFTX0511N	5,0	TRX 20

#### Inserts

Cat. No.	Coated		Dimensions (mm)				Fig.	Applicable holder & insert group	
	AC530U		() CDX: presents max. depth						
	R	L	CW	CDX	RE	E2			
TGA R/L 4140BF01	○	○	1,40	2,5 (2,0-1,7)	0,1	0,300	2	②	
TGA R/L 4150BF	●	●	1,50	3,9	0,2	0,250	2	③	
TGA R/L 4165BF	○	○	1,65			0,175			
TGA R/L 4175BF	○	○	1,75			0,125			
TGA R/L 4185BF	○	○	1,85			0,075			
TGA R/L 4200BF	●	●	2,00			0			1
TGA R/L 4220BF	○	○	2,20						
TGA R/L 4230BF	○	○	2,30	5,4	0,3	0	1	④	
TGA R/L 4250BF	●	●	2,50						
TGA R/L 4265BF	○	○	2,65						
TGA R/L 4270BF	○	○	2,70						
TGA R/L 4280BF	○	○	2,80						
TGA R/L 4300BF	●	●	3,00						
TGA R/L 4320BF	○	○	3,20						
TGA R/L 4330BF	○	○	3,30						
TGA R/L 4350BF	●	●	3,50						
TGA R/L 4370BF	○	○	3,70						
TGA R/L 4390BF	○	○	3,90						
TGA R/L 4400BF	●	●	4,00						0,4
TGA R/L 4410BF	○	○	4,10						
TGA R/L 4420BF	○	○	4,20						
TGA R/L 4430BF	○	○	4,30						
TGA R/L 4440BF	○	○	4,40						
TGA R/L 4450BF	●	○	4,50						

Fig. 1

Fig. 2

Notice: Please note the cutting edge position E2, for grooving widths below 1,85 mm..

(Note 2) Figures show right hand tools.

#### Recommended Cutting Conditions

##### ● Grooving

Wet condition is recommended.

Work Material	General Steel	Stainless Steel	
Cutting speed (m/min)	50-180	50-160	
Groove width (mm)	1,5-2,3	2,5-3,3	3,5-4,5
Feed rate (mm/rev)	0,03-0,12	0,04-0,12	0,05-0,12
Depth of cut (mm)	Ext.	-3,5	-5,0
	Int.	-2,5	

##### ● Axial Feed

Feed direction for axial feed

Wet condition is recommended.

Work Material	General Steel	Stainless Steel	
Cutting speed (m/min)	50-180	50-160	
Feed rate (mm/rev)	0,03-0,10	0,05-0,10	0,07-0,12
Depth of cut (mm)	-0,3	-0,5	-0,7

#### Rake Angle with a Holder Fitted (E)

Grooving	AC530U	H1	T2500Z T3000Z	T1500A	BN2000	DA2200
External GWC, GWCS	10°	20°	10°	5°	0°	10°
Internal GWCI	1°	11°	1°	-4°	-9°	1°

\*) Please select applicable inserts for the holders by using matching group numbers.



# SumiTurn Groove Insert TGA Type



## ■ Square Edged Grooving Insert

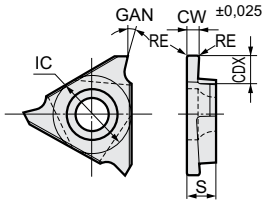

This figure shows right handed tools.

Grade		Cutting Edge	GAN
Coated Carbide	AC530U	Honing	15°
Carbide	H1	Sharp	25°
Coated Cermet	T2500Z,T3000Z	Honing	15°
Cermet	T1500A	Sharp	10°
SUMIBORON	BN2000	K-Land	5°
SUMIDIA	DA2200	Sharp	15°

\* See page F47 for the rake angle with a holder fitted.

Dimensions (mm)

Cat. No. (The part numbers of T1500A end with E)	AC530U		H1		T2500Z		T3000Z		T1500A		BN2000		DA2200		CW	Max. Groove Depth		CDX	RE	IC	S	Insert /Holder Group No.*
	R	L	R	L	R	L	R	L	R	L	R	L	R	L		External	Internal					
	TGA R/L 3033 (E)	○		○		○	○										0,33					
TGA R/L 3050 (E)	○	○	○		○	○	○								0,50	1,2	0,8	1,4				
TGA R/L 3075 (E)	○	○	○		○	○									0,75							
R/L 3095 (E)	○	○			○	○									0,95							
R/L 3100 (E)	○	○	○	○	○	○	○		○	○					1,00							
R/L 3110 (E)	○	○			○	○									1,10							
R/L 3125 (E)	○	○	○		○	○	○		○	○					1,25							
R/L 3135 (E)	○	○			○	○	○		○	○					1,35	2,0	1,5	2,5				
R/L 3145 (E)	○	○	○		○	○									1,45							
R/L 3150 (E)	○	○	○		○	○									1,50							
R/L 3165 (E)	○	○			○	○									1,65				0,1 (T1500A 0,2)	9,525	3,18	①
R/L 3175 (E)	○	○			○	○	○								1,75							
R/L 3185 (E)	○	○			○	○									1,85							
TGA R/L 3200 (E)	○	○	○		○	○	○	○	○						2,00							
R/L 3220 (E)		○			○	○									2,20							
R/L 3230 (E)					○	○									2,30							
R/L 3250 (E)	○		○		○	○									2,50	2,5	2,0	3,0				
R/L 3265 (E)					○	○									2,65							
R/L 3270 (E)					○	○									2,70							
R/L 3280 (E)	○				○	○									2,80							
TGA R/L 4125 (E)	○	○			○	○					□		○		1,25	2,0	1,7	2,5				②
R/L 4145 (E)	○	○			○	○									1,45							
TGA R/L 4150 (E)	○	○	○	○	○	○						○	○		1,50							
R/L 4165 (E)		○			○	○									1,65							
R/L 4175 (E)					○	○									1,75				0,2 *2			③
R/L 4185 (E)		○	○	○	○	○									1,85	3,5	2,5	3,9				
R/L 4200 (E)	○	○			○	○						○	○		2,00							
R/L 4220 (E)		○			○	○									2,20							
R/L 4230 (E)	○	○			○	○									2,30							
TGA R/L 4250 (E)	○		○		○	○			○	○					2,50							
R/L 4265 (E)	○		○		○	○									2,65							
R/L 4270 (E)					○	○									2,70							
R/L 4280 (E)	○				○	○									2,80	5,0 *1	2,5	5,4 *1				
R/L 4300 (E)	○	○			○	○			○	○		○			3,00				0,3 *2	12,70	4,76	
R/L 4320 (E)					○	○									3,20							
R/L 4330 (E)	○				○	○									3,30							
TGA R/L 4350 (E)	○				○	○					□				3,50							④
R/L 4370 (E)					○	○									3,70							
R/L 4390 (E)					○	○									3,90							
R/L 4400 (E)	○				○	○					○		□		4,00							
R/L 4410 (E)					○	○									4,10							
R/L 4420 (E)					○	○									4,20	5,0	2,5	5,4				
R/L 4430 (E)					○	○									4,30				0,4 *2			
R/L 4440 (E)					○	○									4,40							
R/L 4450 (E)			○		○	○									4,50							
R/L 4480 (E)					○	○									4,80							5,00

\* See the group numbers of GWC, GWCS and GWCI types on page F46 and F47 to find applicable holders. Inserts and holders that have corresponding group numbers can be used together.

\*1: CDX for SUMIBORON and SUMIDIA = 4,4, maximum groove depth 4,0 (2,5 during internal machining)

\*2: RE for SUMIBORON = 0,2, RE for SUMIDIA = 0,1

## Round Edged Grooving Insert

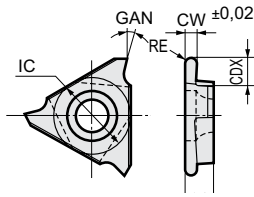

This figure shows right handed tools.

Grade		Cutting Edge	GAN
Coated Carbide	AC530U	Honing	15°
Carbide	H1	Sharp	25°
Coated Cermet	T2500Z, T3000Z	Honing	15°
Cermet	T1500A	Sharp	10°
SUMIBORON	BN2000	K-Land	5°
SUMIDIA	DA2200	Sharp	15°

\* See page F47 for the rake angle with a holder fitted.

Dimensions (mm)

Cat. No.	AC530U		H1		T2500Z		T3000Z		T1500A		BN2000		DA2200		CW	Max. Groove Depth		CDX	RE	IC	S	Insert /Holder Group No.*
	R	L	R	L	R	L	R	L	R	L	R	L	R	L		External	Internal					
TGA R/L 4050 R	○	○			○										1,00	2,0	1,7	2,5	0,50	12,70	4,76	②
TGA R/L 4075 R	○	○			○									1,50	3,5	2,5	3,9	0,75	③			
R/L 4100 R	○	○			○								2,00	1,00					④			
TGA R/L 4125 R	○	○			○								2,50	5,0 <sup>*1</sup>	2,5	5,4 <sup>*1</sup>	1,25	④				
R/L 4150 R	○	○			○		○					□	3,00					1,50				
R/L 4200 R	○	○			○								4,00					2,00				

\* See the group numbers of GWC, GWCS and GWCI types on page F46 and F47 to find applicable holders. Inserts and holders that have corresponding group numbers can be used together.

\*1 CDX for SUMIBORON and SUMIDIA = 4,4, maximum groove depth 4,0 (2,5 during internal machining)

## Recommended Cutting Conditions

Work Material	<b>P</b> General Steel	<b>M</b> Stainless Steel	<b>N</b> Non-Ferrous Metal	<b>H</b> Hardened Steel					
Grade	AC530U	T2500Z, T3000Z	T1500A	AC530U	T2500Z, T3000Z	T1500A	H1	DA2200	BN2000
Cutting Speed (m/min)	50–200	100–180	100–180	50–200	80–150	80–120	200–300	200–300	80–120
Feed Rate (mm/rev)	0,02–0,10	0,05–0,10	0,05–0,08	0,02–0,10	0,05–0,08	0,05–0,08	0,05–0,15	0,05–0,15	0,03–0,07

## Insert Blanks

(Incomplete products. Machine them to meet your edge width, nose radius and rake angle requirements.)

Fig. 1

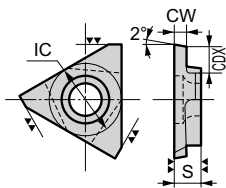
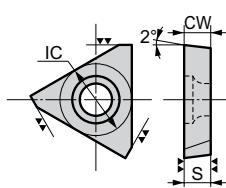

Fig. 2



This figure shows right handed tools.

Dimensions (mm)

Cat. No.	KH03		H1		EH510		T1500A		CW	CDX	IC	S	Fig.
	R	L	R	L	R	L	R	L					
TGA R/L 3 T18									1,85	(3,4)	9,525	3,18	1
R/L 3 T23							○	○	2,35	(3,4)			
R/L 3 T31	○								3,18	–			
TGA R/L 4 T22									2,20	(4,8)	12,70	4,76	1
R/L 4 T37									3,75	(6,2)			
R/L 4 T47	○						○		4,76	–			

Note: CDX values in parentheses are for reference only.

## Notes for Machining an Insert

Make the cutting edge so that the rake angle, back taper, etc. as shown in fig. 3. When you have installed an insert into a holder, it becomes a cutting blade element as shown in fig. 4.

Suggested Shape

Fig. 3

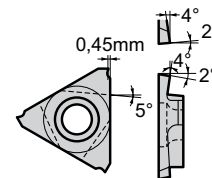

Cutting blade element during holder installation

Fig. 4

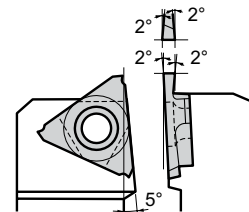

# Parting-Off Mini Holders SCT Type



Parting-Off  
Tools

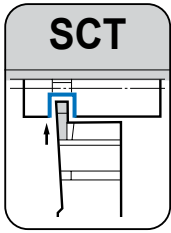

Fig. 1

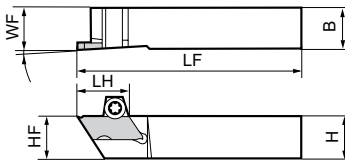
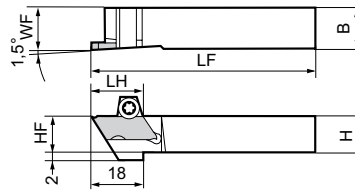
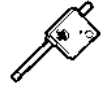

Fig. 2



Above figures show right hand tools.

## ■ Spare Parts



## ■ Holders

Cat. No.	Stock	Dimensions (mm)						Applicable inserts	Fig.	Screw	Wrench
		H	B	LF	WF	HF	LH				
SCT R 1010	●	10	10	120	10	10	15	CT R05_ _ _ CT R12_ _ _	1	BFTX0410T8L	TRX 08
SCT R 1212	●	12	12	120	12	12	15				
SCT R 1616	●	16	16	120	16	16	15				
SCT R 101016	○	10	10	120	10	10	18				
SCT R 121216	○	12	12	120	12	12	18	CT R16_ _ _	1		
SCT R 161616	○	16	16	120	16	16	18				
SCT L 1010	●	10	10	120	10	10	15	CT L05_ _ _ CT L12_ _ _	1	BFTX0410T8R	
SCT L 1212	●	12	12	120	12	12	15				
SCT L 1616	●	16	16	120	16	16	15				
SCT L 101016	○	10	10	120	10	10	18	CT L16_ _ _	1		
SCT L 121216	○	12	12	120	12	12	18				
SCT L 161616	○	16	16	120	16	16	18				

## ■ Inserts

Installation Conditions for Holder	For Right Handed Holder (SCTR)			For Left Handed Holder (SCTL)		
	CTR_R	CTR_N	CTR_L	CTL_R	CTL_N	CTL_L
Insert Shape and Dimensions						

Cat. No.	AC1030U			AC530U			Max. Cut-Off Ø (mm)	CW	RE	L	S	Chip Breaker	Applicable Holder	
	R	N	L	R	N	L								
CTR 050505 R/N/L	○		○	○	○	○	5	0,5	0,05	19	7	With Chip Breaker	SCT R1010 SCT R1212 SCT R1616	
CTR 050500 R/N/L	○	○		○	○		5	0						
CTR 121005 R/N/L	○	○	○	○	○	○	12	1,0						
CTR 121505 R/N/L	●	●	○	○	○	○	12	1,5						
CTR 122005 R/N/L	●	●		○	○		12	2,0						
CTR 121000 R/N/L	○	○		○	○		12	1,0						
CTR 121500 R/N/L	○	○		○	○		12	1,5						
CTR 122000 R/N/L	○	○		○	○		12	2,0						
CTR 161005 R/N/L	○	○		○	○		16	1,0	23,1			8,3	Without Chip Breaker	SCT R101016 SCT R121216 SCT R161616
CTR 161505 R/N/L	○	○		○	○		16	1,5						
CTR 162005 R/N/L	○	○	○	○	○	○	16	2,0						
CTR 161000 R/N/L	○	○		○	○		16	1,0						
CTR 161500 R/N/L	○	○		○	○		16	1,5						
CTR 162000 R/N/L	○	○		○	○		16	2,0						
CTR 050500 R/N/L NB							5	0,5	19	7	Without Chip Breaker	SCT R1010 SCT R1212 SCT R1616		
CTR 121000 R/N/L NB	○			○			12	1,0						
CTR 121500 R/N/L NB	○			○			12	1,5						
CTR 122000 R/N/L NB	○			○			12	2,0						
CTR 161000 R/N/L NB							16	1,0	23,1	8,3	Without Chip Breaker	SCT R101016 SCT R121216 SCT R161616		
CTR 161500 R/N/L NB							16	1,5						
CTR 162000 R/N/L NB	○			○			16	2,0						

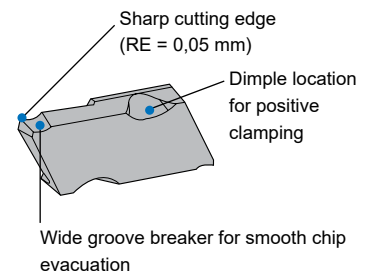

## ● Surface Finish Comparison

	very small	
<b>SCT</b>		<b>Competitor's tool</b>
Work Material:	X6Cr17 ( ø8 mm)	
Insert:	CTR 121005 R, ( b =1,0 mm)	
Cutting Data:	v <sub>c</sub> = 45 m/min f = 0,02 mm/rev, wet	

# Parting-Off Holders Sumi-Grip



## ■ Characteristics

- Holders available in carbide (SumiGrip) and steel (SumiGrip JR).
- Capable on interrupted machining.
- Can be used for cut-off, grooving and chamfering applications.

## ■ Type

- Tool block type  
STFH (steel) / WCFH (carbide)
- Shank type  
STFS (steel) / WCFS (carbide)

## ■ Cut-Off

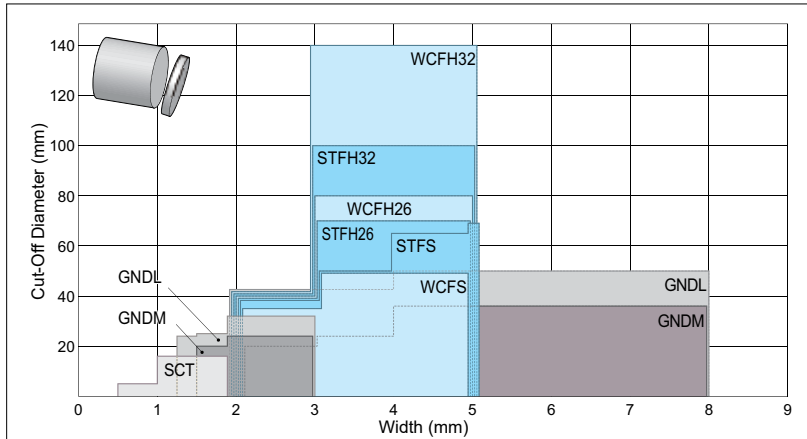

## ■ Features of Design

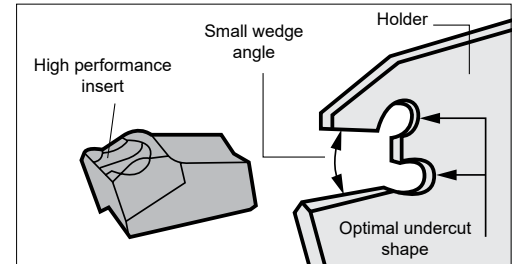

## ■ Twice the Insert Holding Force

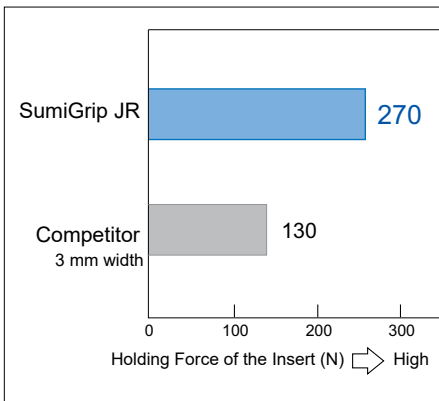

## ■ Low Vibration

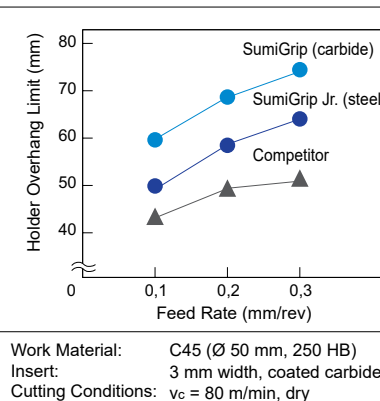

## ■ Wear Resistance

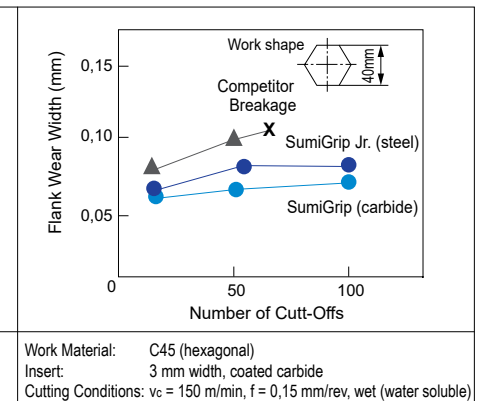

## ■ GG Type/GF Type/CF Type Chipbreaker, Grade AC1030U

Utilizing grooving tool GND type chipbreaker series for excellent chip control.

Low cutting force chipbreaker GF type (neutral) or CF type (left or right handed) inserts, coupled with a carbide blade, enables stable machining and prevents chattering even when machining stainless steel.

Achieving stable and longer tool life with the new AC1030U grade.

GG	GF	CF
Neutral	Neutral	L/R handed
General purpose	Exotic alloy, Low cutting force	Exotic alloy, Low cutting force

## ■ Performance (Chipbreaker)



# Parting-Off Holders

## Sumi-Grip Jr.

### Cut-Off (Steel Holder/Tool Block Type)

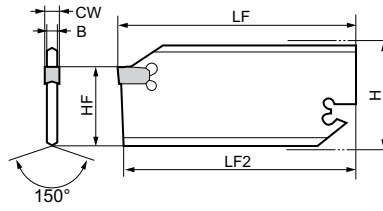
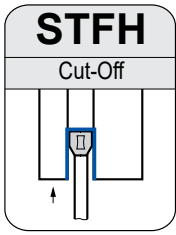

Above figures show right hand tools.

#### Parts



#### ■ Holders

Cat. No.	Stock	Dimensions (mm)						Max. Cut-Off Dia.	Applicable Inserts	Applicable Tool Blocks	Wrench
		H	B	LF	HF	LF2	CW				
STFH 26-2	●	26	1,6	109	21,4	108	2,0	40	WCF _ 2 _	SBN 20-26 SBU 20-26	SL 4
26-3	●	26	2,4	109	21,4	108	3,0	70	WCF _ 3 _		
26-4	●	26	3,4	109	21,4	108	4,0	70	WCF _ 4 _		
26-5	●	26	4,3	109	21,4	108	5,0	70	WCF _ 5 _		
STFH 32-2	●	32	1,6	149	25,0	148	2,0	40	WCF _ 2 _	SBN 20-32	
32-3	●	32	2,4	149	25,0	148	3,0	100	WCF _ 3 _	SBN 25-32	
32-4	●	32	3,4	149	25,0	148	4,0	100	WCF _ 4 _	SBU 20-32	
32-5	●	32	4,3	149	25,0	148	5,0	100	WCF _ 5 _	SBU 25-32	

#### ■ Tool Blocks

#### ■ Parts

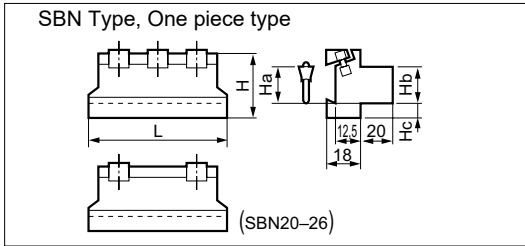

Cat. No.	Stock	Dimensions (mm)					Applicable Carbide Blades
		H	Ha	Hb	Hc	L	
SBN 20-26	●	45	20	20	10,0	80	STFH 26 _
SBN 20-32	●	50	20	20	13,5	100	STFH 32 _
SBN 25-26	□	48	25	25	10,0	80	STFH 26 _
SBN 25-32	●	50	25	25	8,5	110	STFH 32 _

Clamp	Screw	Wrench
BWS 30	WB 8-20	LH 040

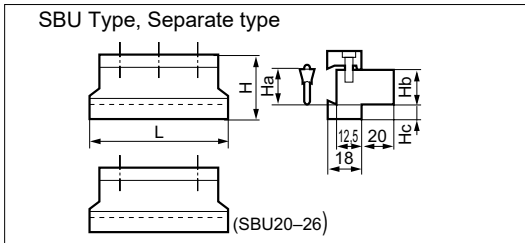

Cat. No.	Stock	Dimensions (mm)					Applicable Carbide Blades
		H	Ha	Hb	Hc	L	
SBU 20-26	●	45	20	20	10,0	80	STFH 26 _
SBU 20-32	●	50	20	20	13,5	100	STFH 32 _
SBU 25-26	□	48	25	25	10,0	80	STFH 26 _
SBU 25-32	●	50	25	25	8,5	110	STFH 32 _

Wedge		
SBU 20-26 SBU 25-26	SBU 20-32	SBU 25-32
BCS 15	BCS 20	BCS 25
Screw	Wrench	
BX 0622	LH 050	

\*Tool blocks selection guide see page F46

### Cut-Off (Steel Holder/Shank Type)

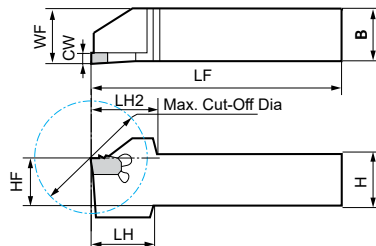
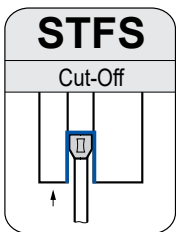

#### ■ Parts



#### ■ Holders

Cat. No.	Stock		Dimensions (mm)							Max. Cut-Off Dia.	Applicable Inserts	Wrench	
	R	L	H	B	LF	WF	HF	LH	LH2				CW
STFS R/L 1010-2	○		10	10	86	10	10	17	17	2,0	28	WCF _ 2 _	SL 4
R/L 1212-2	●	●	12	12	110	12	12	18	18	2,0	30		
R/L 1616-2	●	○	16	16	110	16	16	-	19	2,0	32		
R/L 2020-2	●	○	20	20	125	20	20	-	24	2,0	40		
STFS R/L 1616-3	●	○	16	16	110	16	16	20	22	3,0	35	WCF _ 3 _	
R/L 2012-3	○		20	12	110	12	20	-	24	3,0	40		
R/L 2020-3	●	●	20	20	125	20	20	-	30	3,0	50		
R/L 2525-3	●	●	25	25	150	25	25	-	30	3,0	50		
STFS R/L 2020-4	●	●	20	20	125	20	20	-	33	4,0	55	WCF _ 4 _	
R/L 2525-4	●	●	25	25	150	25	25	-	38	4,0	65		
STFS R/L 2020-5	○		20	20	125	20	20	-	35	5,0	60	WCF _ 5 _	
R/L 2525-5	○	○	25	25	150	25	25	-	40	5,0	70		

● = Euro stock  
○ = Japan stock

□ = Delivery on request

# Parting-Off Holders Sumi-Grip Jr. Inserts

## Inserts

Neutral (N)		Right Handed (R)		Left Handed (L)							
						* WCF_2T: 2_RE=0,15					
External Appearance	Cat. No.	AC830P	AC225	AC1030U	T1500A	A30	G10E	CW	Applicable Holder		
WCF N_GG General purpose 	WCF N2 GG	●						2,0	STFH __ 2	STFS R/L ___ 2	
	N3 GG	●						3,0	STFH __ 3	STFS R/L ___ 3	
	N4 GG	●						4,0	STFH __ 4	STFS R/L ___ 4	
	N5 GG	●						5,0	STFH __ 5	STFS R/L ___ 5	
WCF N_GF Exotic alloy Low feed 	WCF N2 GF			○				2,0	STFH __ 2	STFS R/L ___ 2	
	N3 GF			○				3,0	STFH __ 3	STFS R/L ___ 3	
	N4 GF			○				4,0	STFH __ 4	STFS R/L ___ 4	
	N5 GF			○				5,0	STFH __ 5	STFS R/L ___ 5	
WCF __ CF Exotic alloy Low feed 	WCF R3 CF			○				3,0	STFH __ 3	STFS R/L ___ 3	
	L3 CF			○				3,0			
	R4 CF							4,0	STFH __ 4	STFS R/L ___ 4	
	L4 CF			○				4,0			
WCF _2T Small diameter Low cutting force 	WCF N2T	●						2,0			
	R2T	●						2,0	STFH __ 2	STFS R/L ___ 2	
	L2T	●						2,0			
WCF __ Without chip breaker General steel 	WCF N3	●						3,0			
	R3	●						3,0	STFH __ 3	STFS R/L ___ 3	
	L3	●						3,0			
	WCF N4	●						4,0			
	R4	●						4,0	STFH __ 4	STFS R/L ___ 4	
	L4	●						4,0			
	WCF N5	●						5,0			
	R5	●						5,0	STFH __ 5	STFS R/L ___ 5	
	L5	●						5,0			
WCF __ A Exotic alloy Low feed 	WCF N2A	●	●		○			2,0	STFH __ 2	STFS R/L ___ 2	
	WCF N3A	●	●					3,0			
	R3A	●	●					3,0	STFH __ 3	STFS R/L ___ 3	
	L3A	●	●					3,0			
	WCF N4A	○	●				○	4,0			
	R4A		●					4,0	STFH __ 4	STFS R/L ___ 4	
	L4A		●					4,0			
	WCF N5A		●					5,0			
R5A		○					5,0	STFH __ 5	STFS R/L ___ 5		
L5A	●						5,0				
WCF __ B Cast iron Light alloys 	WCF N3B						●	3,0			
	R3B						●	3,0	STFH __ 3	STFS R/L ___ 3	
	L3B						●	3,0			
	WCF N4B						●	4,0			
	R4B						○	4,0	STFH __ 4	STFS R/L ___ 4	
	L4B						○	4,0			
	WCF N5B						○	5,0			
	R5B							5,0	STFH __ 5	STFS R/L ___ 5	
L5B							5,0				

## Recommended Cutting Conditions

Work Material		Cutting Speed (m/min)					
		AC830P	AC225	AC1030U	T1500A	A30	G10
Steel	General Steel	80-200	80-200	50-200	80-200	50-120	-
	Soft Steel	100-230	100-230	50-230	100-230	70-150	-
	Die Steel	60-150	60-150	50-150	60-150	50-120	-
Stainless Steel		70-150	70-150	50-150	-	70-130	-
Cast Iron		-	-	50-200	-	-	50-120
Non-Ferrous Metal		-	-	200-500	-	-	200-500

Chip Breaker		Feed Rate (mm/rev)										
		Neutral					Left or Right Handed					
		GG	GF	Without Chip Breaker	T	A	B	Without Chip Breaker	CF	T	A	B
		General Purpose	Exotic Alloy Low Cutting Force	General Steel	Small Diam. Low Cutting Force	Exotic Alloy Low Feed	Cast Iron Light Alloys	General Steel	Exotic Alloy Low Cutting Force	Small Diam. Low Cutting Force	Exotic Alloy Low Feed	Cast Iron Light Alloys
Groove Width	2,0	0,05-0,20	0,03-0,12	-	0,03-0,10	0,03-0,12	-	-	-	0,03-0,10	-	-
W	3,0	0,08-0,25	0,04-0,15	0,08-0,25	-	0,04-0,15	0,05-0,15	0,08-0,25	0,08-0,12	-	0,04-0,15	0,05-0,15
(mm)	4,0	0,10-0,30	0,05-0,18	0,10-0,30	-	0,05-0,18	0,05-0,18	0,10-0,30	0,10-0,30	-	0,05-0,18	0,05-0,18
	5,0	0,10-0,35	0,05-0,20	0,10-0,30	-	0,05-0,20	0,06-0,20	0,10-0,20	0,10-0,30	-	-	0,06-0,20



# Parting-Off Holders

## Sumi-Grip Series

### Cut-Off (Carbide Holder/Tool Block Type)

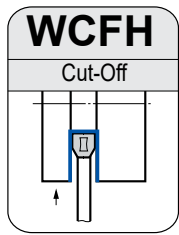

CW: 3 mm  
4 mm  
5 mm

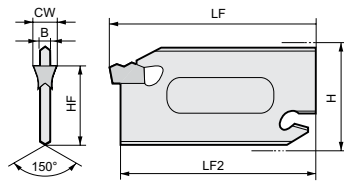

CW: 2 mm

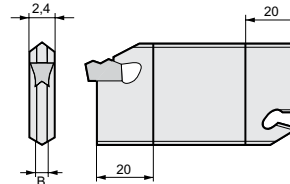

(WCFH 32-2)

#### Parts



Above figures show right hand tools.

#### ■ Holders

Cat. No.	Stock	Dimensions (mm)						Max. Cut-Off Dia.	Applicable Inserts	Applicable Tool Blocks	Wrench
		H	B	LF	HF	LF2	CW				
WCFH 26-2	●	26	1,7	110	21,4	109,0	2,0	40	WCF_2_	SBN 20-26 SBU 20-26	SL 2
26-3	●	26	2,4	110	21,4	108,5	3,0	70	WCF_3_		SL 1
26-4	●	26	3,4	110	21,4	108,5	4,0	70	WCF_4_		
26-5	●	26	4,3	110	21,4	108,5	5,0	70	WCF_5_		
WCFH 32-2	●	32	1,7	150	25,0	149,0	2,0	40	WCF_2_	SBN 20-32 SBN 25-32 SBU 20-32 SBU 25-32	SL 2
32-3	●	32	2,4	150	25,0	148,5	3,0	100	WCF_3_		SL 1
32-4	●	32	3,4	150	25,0	148,5	4,0	100	WCF_4_		
32-5	●	32	4,3	150	25,0	148,5	5,0	100	WCF_5_		

See F48 for applicable inserts.

#### ■ Tool Blocks

#### ■ Parts

SBN Type, Mono-block Type		Cat. No.	Stock	Dimensions (mm)					Applicable Carbide Blades
H	Ha			Hb	Hc	L			
●	45	20	20	10,0	80	WCFH 26_			
●	50	20	20	13,5	100	WCFH 32_			
□	48	25	25	10,0	80	WCFH 26_			
●	50	25	25	8,5	110	WCFH 32_			

Clamp	Screw	Wrench
BWS 30	WB 8-20	LH 040

SBU Type, Separate Type		Cat. No.	Stock	Dimensions (mm)					Applicable Carbide Blades
H	Ha			Hb	Hc	L			
●	45	20	20	10,0	80	WCFH 26_			
●	50	20	20	13,5	100	WCFH 32_			
□	48	25	25	10,0	80	WCFH 26_			
●	50	25	25	8,5	110	WCFH 32_			

Wedge		
20-26 SBU 25-26	SBU 20-32	SBU 25-32
BCS 15	BCS 20	BCS 25
Screw	Wrench	
BX 0622	LH 050	

#### ■ Tool Block Type Selection Guide

Tool Block (Mono-Block Type)	<h4>SBN Type</h4> <p>This tool block can be used for the machining tool post <b>A</b> shown on the right.</p>	<h4>A</h4> General Purpose Lathe, etc. SBN Type, SBU Type <p>(Overhead clamp)</p>	<h4>B</h4> Turret Type Tool Post, etc. SBU Type <p>(Side clamp)</p>
Tool Block (Separate Type)	<h4>SBU Type</h4> <p>This tool block can be used for the machining tool posts <b>A</b> and <b>B</b> shown on the right. Since the clamp is large it has a large scope even when the holder has a long overhang.</p>		

● = Euro stock  
○ = Japan stock

□ = Delivery on request

# Parting-Off Holders Sumi-Grip Series

## Cut-Off (Carbide Holder/Shank Type)

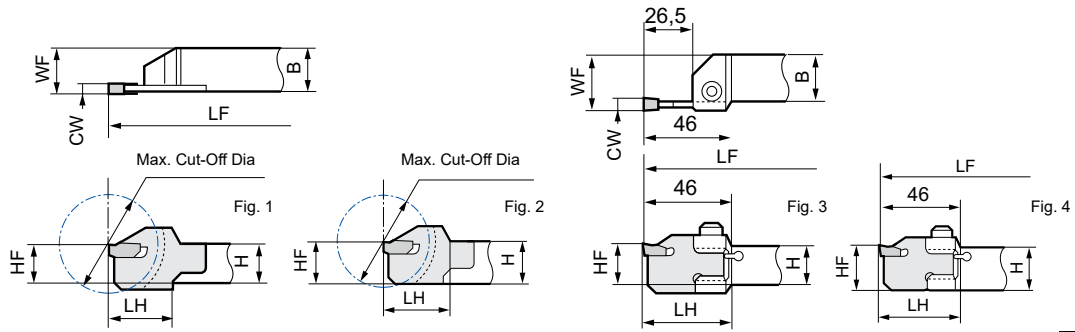
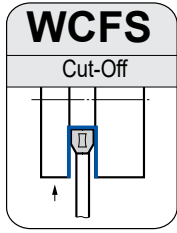

### Parts

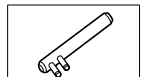

### Holdings

Cat. No.	Stock		Dimensions (mm)								Max. Cut-Off Dia.	Applicable Blades	Applicable Inserts	Fig.	Wrench
	R	L	H	B	LF	WF	HF	LH	CW						
Brazed Type	WCFS R/L 1010-2	●		10	10	86	10	10	10	2,0	28	—	WCF_2_2	1	SL 2
	R/L 1212-2	●		12	12	110	12	12	18	2,0	30	—	WCF_2_1	1	
	R/L 1616-2	○	○	16	16	100	16	16	25	2,0	35	—	WCF_2_2	2	SL 1
R/L 1616-3			16	16	100	16	16	25	3,0	35	—	WCF_3_3	2		
Clamp Type	WCFS R/L 20-3	●	●	20	20	125	23	20	46	3,0	50	WCFH17-3	WCF_3_3	3	SL 1
	R/L 20-4	●		20	20	125	24	20	46	4,0	50	WCFH17-4	WCF_4_3	3	
	R/L 20-5	○		20	20	125	25	20	46	5,0	50	WCFH17-5	WCF_5_3	3	
	WCFS R/L 25-3	●		25	25	150	28	25	46	3,0	50	WCFH17-3	WCF_3_4	4	
	R/L 25-4		○	25	25	150	29	25	46	4,0	50	WCFH17-4	WCF_4_4	4	
R/L 25-5			25	25	150	30	25	46	5,0	50	WCFH17-5	WCF_5_4	4		

See F48 for applicable inserts.

Blade included in holder.

### Blades

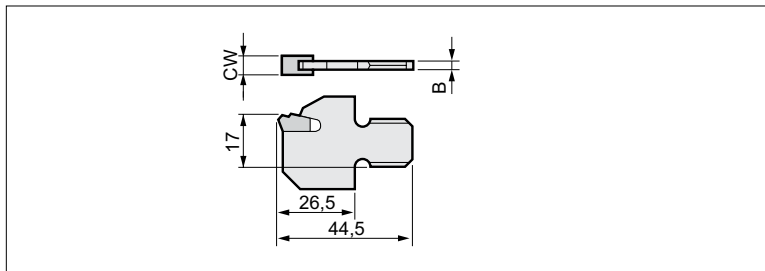







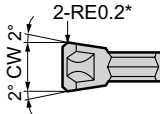
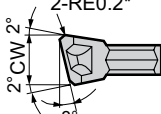
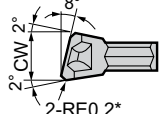

Cat. No.	Stock	Dimensions (mm)		Applicable Blades
		CW	B	
WCFH 17-3	●	3	2,4	WCFS R/L 20-3, 25-3
WCFH 17-4	○	4	3,4	WCFS R/L 20-4, 25-4
WCFH 17-5		5	4,3	WCFS R/L 20-5, 25-5

### Parts

Cap Screw	Wrench	Applicable Holders
BX0622	LH050	All clamp type holders.

# Parting-Off Holders Sumi-Grip Inserts

## Inserts

Neutral (N)		Right Handed (R)		Left Handed (L)							
						* WCF_2T: 2_RE=0,15					
External Appearance	Cat. No.	AC830P	AC225	AC1030U	T1500A	A30	G10E	CW	Applicable Holder		
WCF N_GG General purpose 	WCF N2 GG	●						2,0	STFH __ 2	STFS R/L ____ 2	
	N3 GG	●						3,0	STFH __ 3	STFS R/L ____ 3	
	N4 GG	●						4,0	STFH __ 4	STFS R/L ____ 4	
	N5 GG	●						5,0	STFH __ 5	STFS R/L ____ 5	
WCF N_GF Exotic alloy Low feed 	WCF N2 GF			○				2,0	STFH __ 2	STFS R/L ____ 2	
	N3 GF			○				3,0	STFH __ 3	STFS R/L ____ 3	
	N4 GF			○				4,0	STFH __ 4	STFS R/L ____ 4	
	N5 GF			○				5,0	STFH __ 5	STFS R/L ____ 5	
WCF __ CF Exotic alloy Low feed 	WCF R3 CF			○				3,0	STFH __ 3	STFS R/L ____ 3	
	L3 CF			○				3,0			
	R4 CF							4,0	STFH __ 4	STFS R/L ____ 4	
	L4 CF			○				4,0			
WCF _2T Small diameter Low cutting force 	WCF N2T	●						2,0			
	R2T	●						2,0	STFH __ 2	STFS R/L ____ 2	
	L2T	●						2,0			
WCF __ Without chip breaker General steel 	WCF N3	●						3,0			
	R3	●						3,0	STFH __ 3	STFS R/L ____ 3	
	L3	●						3,0			
	WCF N4	●						4,0			
	R4	●						4,0	STFH __ 4	STFS R/L ____ 4	
	L4	●						4,0			
	WCF N5	●						5,0			
	R5	●						5,0	STFH __ 5	STFS R/L ____ 5	
L5	●						5,0				
WCF __ A Exotic alloy Low feed 	WCF N2A		●					2,0	STFH __ 2	STFS R/L ____ 2	
	WCF N3A	●	●		○			3,0	STFH __ 3	STFS R/L ____ 3	
	R3A		●					3,0			
	L3A		●					3,0			
	WCF N4A	○	●				○	4,0			
	R4A		●					4,0	STFH __ 4	STFS R/L ____ 4	
	L4A		●					4,0			
WCF N5A		●					5,0				
R5A		○					5,0	STFH __ 5	STFS R/L ____ 5		
L5A	●						5,0				
WCF __ B Cast iron Light alloys 	WCF N3B						●	3,0			
	R3B						●	3,0	STFH __ 3	STFS R/L ____ 3	
	L3B						●	3,0			
	WCF N4B						●	4,0			
	R4B						○	4,0	STFH __ 4	STFS R/L ____ 4	
	L4B							4,0			
	WCF N5B						○	5,0			
R5B							5,0	STFH __ 5	STFS R/L ____ 5		
L5B							5,0				

## Recommended Cutting Conditions

Work Material		Cutting Speed (m/min)					
		AC830P	AC225	AC1030U	T1500A	A30	G10
Steel	General Steel	80-200	80-200	50-200	80-200	50-120	-
	Soft Steel	100-230	100-230	50-230	100-230	70-150	-
	Die Steel	60-150	60-150	50-150	60-150	50-120	-
Stainless Steel		70-150	70-150	50-150	-	70-130	-
Cast Iron		-	-	50-200	-	-	50-120
Non-Ferrous Metal		-	-	200-500	-	-	200-500

Chip Breaker		Feed Rate (mm/rev)										
		Neutral						Left or Right Handed				
		GG	GF	Without Chip Breaker	T	A	B	Without Chip Breaker	CF	T	A	B
		General Purpose	Exotic Alloy Low Cutting Force	General Steel	Small Diam. Low Cutting Force	Exotic Alloy Low Feed	Cast Iron Light Alloys	General Steel	Exotic Alloy Low Cutting Force	Small Diam. Low Cutting Force	Exotic Alloy Low Feed	Cast Iron Light Alloys
Groove Width W (mm)	2,0	0,05-0,20	0,03-0,12	-	0,03-0,10	0,03-0,12	-	-	-	0,03-0,10	-	-
	3,0	0,08-0,25	0,04-0,15	0,08-0,25	-	0,04-0,15	0,05-0,15	0,08-0,25	0,08-0,12	-	0,04-0,15	0,05-0,15
	4,0	0,10-0,30	0,05-0,18	0,10-0,30	-	0,05-0,18	0,05-0,18	0,10-0,30	0,10-0,30	-	0,05-0,18	0,05-0,18
	5,0	0,10-0,35	0,05-0,20	0,10-0,30	-	0,05-0,20	0,06-0,20	0,10-0,20	0,10-0,30	-	-	0,06-0,20

● = Euro stock  
○ = Japan stock



# Threading Tools

## SSTE / SSTI Type



### ■ Features

- High-precision inserts with/without wiper flat for threading, supporting a wide range of applications from general industrial machinery to pipes and aerospace devices
- Stable chip control through use of a 3D molded chipbreaker.
- Ground cutting edge flank for improved cutting edge sharpness, resulting in high quality threads

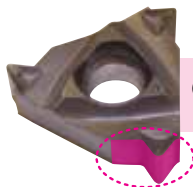

Ground flanks around cutting edge

### ■ Product Range

Applications	Type	Wiper Flat	External/ Internal	Pitch																Insert Cat. No. Example:		
				Pitch (mm)	TPI (Threads/Inch)																	
					48	36	32	28	27	24	20	19	18	16	14	13	12	11	10		8	
General Industrial Use	60° General-purpose Thread	No	External	0.5 ————— 3.0		48 to 8																16ER A60-CB
			Internal	0.5 ————— 3.0		48 to 8																16IR A60-CB
	55° General-purpose Thread		External			48 to 8																16ER A55-CB
			Internal			48 to 8																16IR A55-CB
	60° ISO Metric Thread		External	0.75 — 1.0 — 1.25 — 1.5 — 1.75 — 2.0 — 2.5 — 3.0																		16ER 075ISO-CB
			Internal	0.75 — 1.0 — 1.25 — 1.5 — 1.75 — 2.0 — 2.5 — 3.0																		16IR 075ISO-CB
60° Unified Thread	External																			16ER 32UN-CB		
	Internal																			16IR 32UN-CB		
Pipe Coupling for Gas, Water and Water Faucets	55° Parallel Thread for Pipe/Whitworth	Yes	External																			16ER 36W-CB
			Internal																			16IR 28W-CB
60° American NPT	External																				16ER 27NPT-CB	
	Internal																				16IR 27NPT-CB	
Steam, Gas and Water Supply Pipes	55° Taper Thread for Pipe BSPT		External																			16ER 28BSPT-CB
			Internal																			16IR 28BSPT-CB
60° American NPTF	External																			16ER 27NPTF-CB		
	Internal																			16IR 27NPTF-CB		
For Aerospace Equipment	UNJ 60°	External																			16ER 32UNJ-CB	
		Internal																			16IR 32UNJ-CB	

### ■ Application Examples

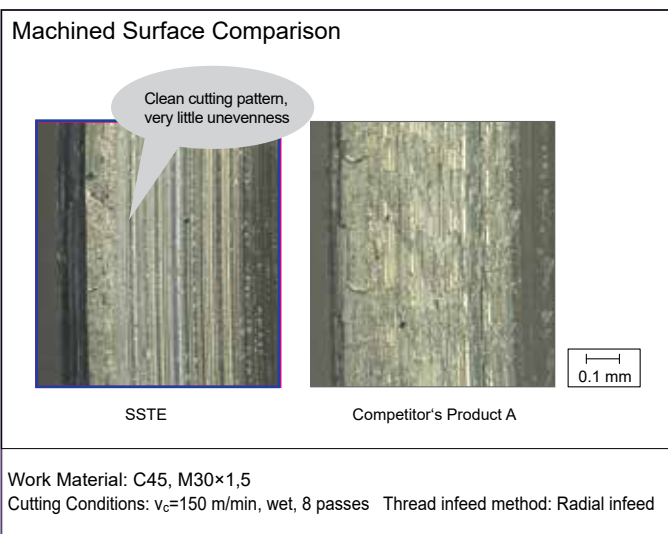
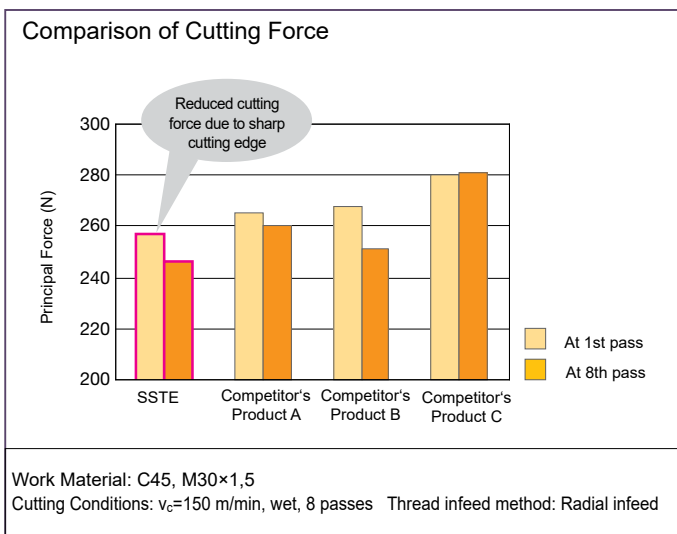

Threading Holders

# Threading Tools

## SSTE / SSTI Type



### Screw-on for External Diameter

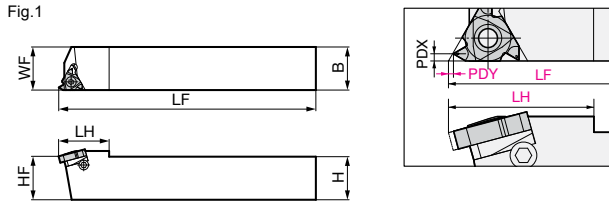
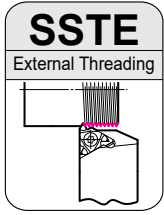

The values for dimensions LF and LH below are only for reference.  
The actual value is the value below minus the PDY value for the corresponding insert on F65.

### Holder

### Parts

Dimensions (mm)

Cat. No.	Stock	Height H	Width B	Overall Length LF	Head LH	Cutting Edge		Fig						
						Functional Width WF	Height HF		Screw	Shim Screw	Flat Washer	Shim	Wrench	
SSTE R1616H16	●	16	16	100	20,5	16	16	1						
SSTE R2020K16	●	20	20	125	30,0	20	20	1	BFTX0312N	2,0	BX0304*1	PW3	YE3	TRX10
SSTE R2525M16	●	25	25	150	30,0	25	25	1						

\*1 Shim screw wrench is sold separately.



### Screw-on for Internal Diameter

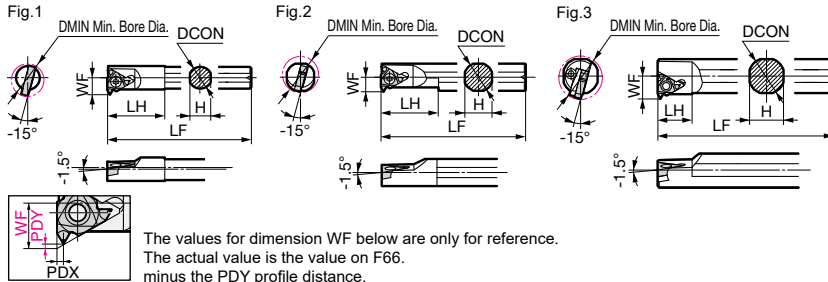
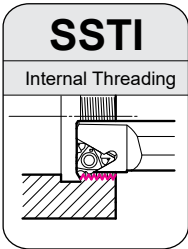

The values for dimension WF below are only for reference.  
The actual value is the value on F66 minus the PDY profile distance.

### Holder

### Parts

Dimensions (mm)

Cat. No.	Stock	Diameter DCON	Height H	Overall Length LF	Head LH	Functional Width WF	Min. Bore Dia. DMIN*2	Fig						
									Screw	Shim Screw	Flat Washer	Shim	Wrench	
SSTI R1812M16*3	●	12	11,0	150	32,0	10,2	18	1						
SSTI R2016M16*3	●	16	15,0	150	63,5	9,2	20	2	BFTX03085N	2,0	-	-	-	
SSTI R2420Q16	●	20	18,0	180	19,0	13,5	24	3						
SSTI R3125S16	●	25	23,0	250	14,3	16,5	31	3	BFTX0312N	2,0	BX0304*1	PW3	YI3	TRX10
SSTI R3732S16	●	32	30,0	250	14,3	20,0	37	3						

\*1 Shim screw wrench is sold separately. \*2 The minimum bore diameter is the diameter of the prepared hole. \*3 Left-hand threads are not available.

### Shim and Selection Criteria

Applications	Recommended Lead Angle (T <sub>1</sub> )	External Turning		Internal Boring	
		Cat. No.	Stock	Cat. No.	Stock
Right-hand Thread	4,5°	YE3-3P	○	YI3-3P	○
	3,5°	YE3-2P	○	YI3-2P	○
	2,5°	YE3-1P	○	YI3-1P	○
	1,5°	YE3*4	○	YI3*4	○
	0,5°	YE3-1N	○	YI3-1N	○
Left-hand Thread	-0,5°	YE3-2N	○	YI3-2N	○
	-1,5°	YE3-3N	○	YI3-3N	○

\*4 Standard shim supplied with holder.

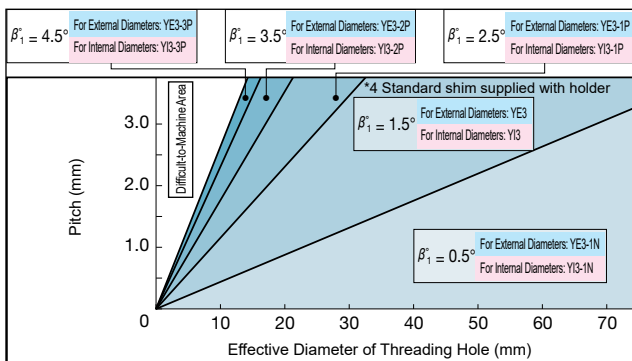

### Holder Identification Code

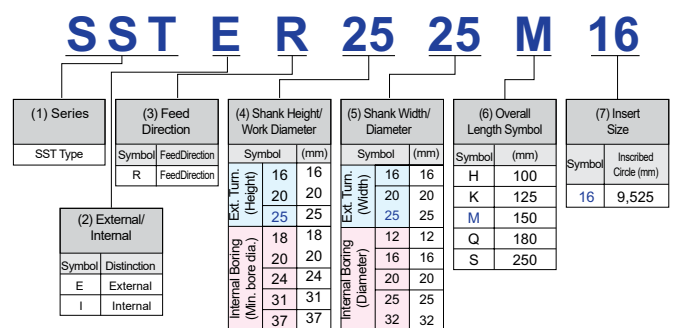

Details of Shim Selection → F67



# Threading Inserts SSTE Type



## Threading Inserts for External Diameter Machining

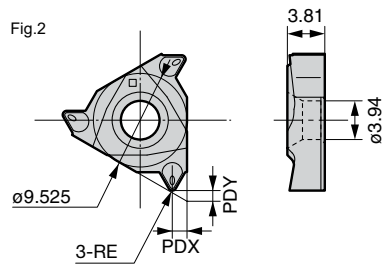
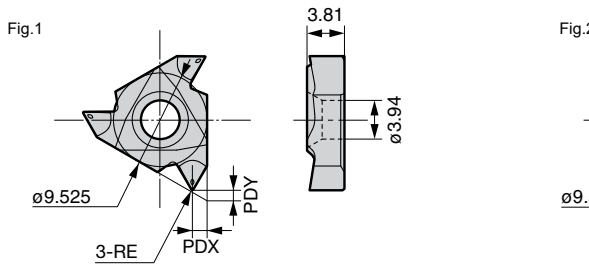

### 60°/55° General-purpose Threads (Without Wiper Flat) Dimensions (mm)

Included Angle	Cat. No.	AC530U	Pitch		X Direction PDX	Y Direction PDY	Corner Radius RE	Pcs/ Pack	Fig
			mm	Threads/ Inch					
60°	16ER A60-CB	●	0,5-1,5	16 - 48	0,8	0,6	0,09	5	1
	16ER AG60-CB	●	0,5-3,0	8 - 48	1,5	1,1	0,10		
	16ER G60-CB	○	2,0-3,0	8 - 14	1,5	1,1	0,20		
55°	16ER A55-CB	●	—	16 - 48	0,8	0,5	0,05	5	1
	16ER AG55-CB	●	—	8 - 48	1,5	1,1	0,08		
	16ER G55-CB	○	—	8 - 14	1,5	1,1	0,22		

### 60° American NPT (With Wiper Flat) Dimensions (mm)

Included Angle	Cat. No.	AC530U	Pitch		X Direction PDX	Y Direction PDY	Corner Radius RE	Pcs/ Pack	Fig
			mm	Threads/ Inch					
60°	16ER 27NPT-CB	○	—	27	0,8	0,6	0,06	5	2
	16ER 18NPT-CB	○	—	18	0,8	0,6	0,06		
	16ER 14NPT-CB	○	—	14	1,5	1,0	0,08		
	16ER 115NPT-CB	○	—	11,5	1,5	1,0	0,08		
	16ER 08NPT-CB	○	—	8	1,5	1,1	0,13		

### 60° ISO Metric Thread (With Wiper Flat) Dimensions (mm)

Included Angle	Cat. No.	AC530U	Pitch		X Direction PDX	Y Direction PDY	Corner Radius RE	Pcs/ Pack	Fig
			mm	Threads/ Inch					
60°	16ER 075 ISO-CB	●	0,75	—	0,5	1,0	0,09	5	2
	16ER 100 ISO-CB	●	1,00	—	0,8	0,6	0,14		
	16ER 125 ISO-CB	●	1,25	—	0,8	0,7	0,15		
	16ER 150 ISO-CB	●	1,50	—	0,8	0,7	0,20		
	16ER 175 ISO-CB	●	1,75	—	1,5	1,0	0,23		
	16ER 200 ISO-CB	●	2,00	—	1,5	1,1	0,26		
	16ER 250 ISO-CB	●	2,50	—	1,5	1,2	0,33		
	16ER 300 ISO-CB	●	3,00	—	1,5	1,1	0,41		

### 55° Taper Thread for Pipe/BSPT (With Wiper Flat) Dimensions (mm)

Included Angle	Cat. No.	AC530U	Pitch		X Direction PDX	Y Direction PDY	Corner Radius RE	Pcs/ Pack	Fig
			mm	Threads/ Inch					
55°	16ER 28BSPT-CB	○	—	28	0,8	0,6	0,13	5	2
	16ER 19BSPT-CB	○	—	19	0,8	0,6	0,18		
	16ER 14BSPT-CB	○	—	14	1,5	1,3	0,25		
	16ER 11BSPT-CB	○	—	11	1,5	1,0	0,31		

### 60° American NPTF (With Wiper Flat) Dimensions (mm)

Included Angle	Cat. No.	AC530U	Pitch		X Direction PDX	Y Direction PDY	Corner Radius RE	Pcs/ Pack	Fig
			mm	Threads/ Inch					
60°	16ER 27NPTF-CB	○	—	27	0,8	0,6	0,06	5	2
	16ER 18NPTF-CB	○	—	18	0,8	0,6	0,06		
	16ER 14NPTF-CB	○	—	14	1,5	1,0	0,13		
	16ER 115NPTF-CB	○	—	11,5	1,5	1,0	0,12		

### 60° Unified Thread (With Wiper Flat) Dimensions (mm)

Included Angle	Cat. No.	AC530U	Pitch		X Direction PDX	Y Direction PDY	Corner Radius RE	Pcs/ Pack	Fig
			mm	Threads/ Inch					
60°	16ER 32UN-CB	○	—	32	0,5	1,0	0,10	5	2
	16ER 28UN-CB	○	—	28	0,8	0,7	0,11		
	16ER 24UN-CB	○	—	24	0,8	0,7	0,13		
	16ER 20UN-CB	○	—	20	0,8	0,7	0,16		
	16ER 18UN-CB	○	—	18	0,8	0,7	0,18		
	16ER 16UN-CB	○	—	16	0,8	0,8	0,20		
	16ER 14UN-CB	○	—	14	1,5	1,2	0,23		
	16ER 13UN-CB	○	—	13	1,5	1,1	0,26		
	16ER 12UN-CB	○	—	12	1,5	1,0	0,27		
	16ER 10UN-CB	○	—	10	1,5	1,2	0,33		
	16ER 08UN-CB	○	—	8	1,5	1,2	0,42		

### 60° UNJ (With Wiper Flat) Dimensions (mm)

Included Angle	Cat. No.	AC530U	Pitch		X Direction PDX	Y Direction PDY	Corner Radius RE	Pcs/ Pack	Fig
			mm	Threads/ Inch					
60°	16ER 32UNJ-CB	○	—	32	0,5	1,0	0,13	5	2
	16ER 28UNJ-CB	○	—	28	0,8	0,6	0,15		
	16ER 24UNJ-CB	○	—	24	0,8	0,6	0,18		
	16ER 20UNJ-CB	○	—	20	0,8	0,7	0,21		
	16ER 18UNJ-CB	○	—	18	0,8	0,6	0,23		
	16ER 16UNJ-CB	○	—	16	0,8	0,6	0,25		
	16ER 14UNJ-CB	○	—	14	1,5	1,1	0,29		
	16ER 12UNJ-CB	○	—	12	1,5	1,1	0,34		
	16ER 10UNJ-CB	○	—	10	1,5	1,1	0,40		

### 55° Parallel Thread for Pipe/Whitworth (With Wiper Flat) Dimensions (mm)

Included Angle	Cat. No.	AC530U	Pitch		X Direction PDX	Y Direction PDY	Corner Radius RE	Pcs/ Pack	Fig
			mm	Threads/ Inch					
55°	16ER 36W-CB	○	—	36	0,5	1,0	0,10	5	2
	16ER 32W-CB	○	—	32	0,5	1,0	0,11		
	16ER 28W-CB	○	—	28	0,8	0,6	0,12		
	16ER 24W-CB	○	—	24	0,8	0,6	0,15		
	16ER 20W-CB	○	—	20	0,8	0,6	0,18		
	16ER 19W-CB	○	—	19	0,8	0,6	0,18		
	16ER 18W-CB	○	—	18	0,8	0,6	0,19		
	16ER 16W-CB	○	—	16	0,8	0,6	0,22		
	16ER 14W-CB	○	—	14	1,5	1,0	0,25		
	16ER 12W-CB	○	—	12	1,5	1,1	0,29		
	16ER 11W-CB	○	—	11	1,5	1,1	0,32		
	16ER 10W-CB	○	—	10	1,5	1,1	0,35		
	16ER 08W-CB	○	—	8	1,5	1,1	0,43		

For these inserts, only SSTE Type holders can be used.

- = Euro stock
- = Japan stock

### Insert Identification Table

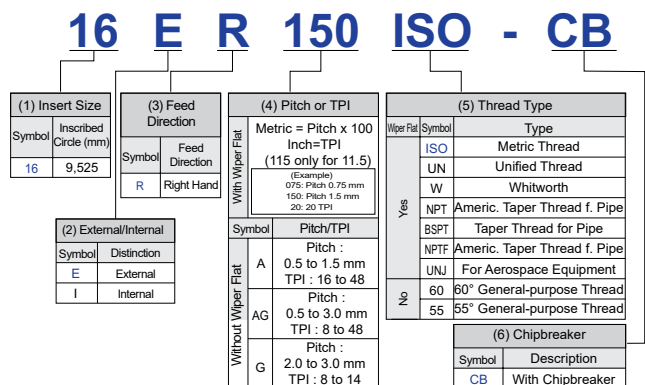



# Threading Tools

## SSTE / SSTI Type

### Shim Selection

If the pitch is large or thread diameter is small, the lead angle of the thread becomes larger and the effective relief angle of the leading edge becomes smaller. It is ideal to set the threading insert so that both right and left relief angles are equal.

Therefore, it is necessary to select an appropriate shim based on the thread pitch and effective diameter using the table below.

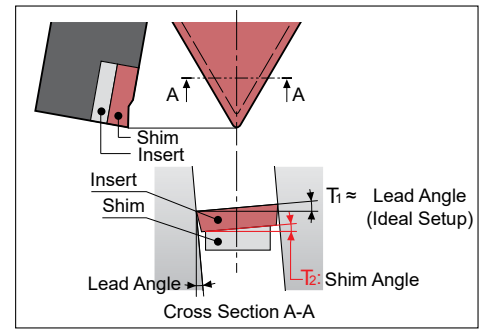

### Shim Selection Procedure

- (1) Choose from [Right-Hand Thread / Left-Hand Thread] in the table.
- (2) Locate the required threading „pitch“.
- (3) Locate the cell with the required „Effective Diameter“ range.
- (4) Confirm the part no. at the „Shim“ row above the corresponding „Effective Diameter“ cell located previously. If the shim part no. is different from the one currently in use, change to the correct one.

Example: When machining an M16×2,0 external right-hand thread, the pitch diameter is 14.701 mm. In the table below, locate [2,0] mm under the "Pitch" column and then move along the row to the right to locate the required "Effective Diameter" range [11,4 - 17,4] mm. As such, the correct shim should be [YE3-1P], shown in the corresponding cell under the "Internal" row below.

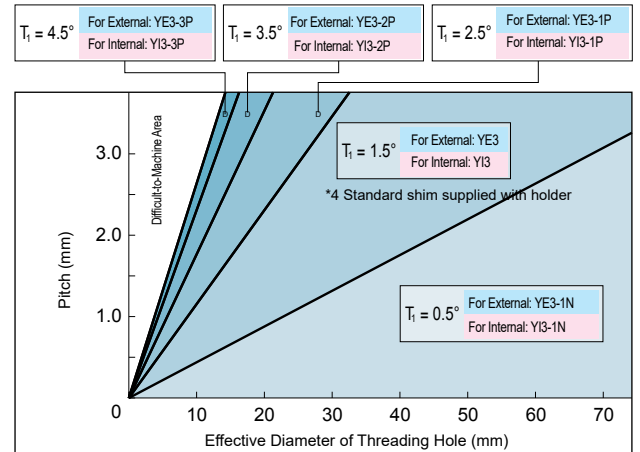

### Pitch (mm)

Right-hand/Left-hand Thread	For Right-hand Thread					For Left-hand Thread		
Lead Angle	4,5°	3,5°	2,5°	1,5°	0,5°	-0,5°	-1,5°	
Shim	External	YE3-3P	YE3-2P	YE3-1P	<b>YE3*</b>	YE3-1N	YE3-2N	YE3-3N
	Internal	YI3-3P	YI3-2P	YI3-1P	<b>YI3*</b>	YI3-1N	YI3-2N	YI3-3N
Shim Angle (Ti)	3°	2°	1°	0°	-1°	-2°	-3°	
Pitch (mm)	Effective Diameter (mm)							
<b>0,5</b>	1,9 - 2,2	2,2 - 2,8	2,8 - 4,3	4,3 - 11,4	> 11,4	> 11,4	11,4 - 4,3	
<b>0,75</b>	2,8 - 3,3	3,3 - 4,3	4,3 - 6,5	6,5 - 17,1	> 17,1	> 17,1	17,1 - 6,5	
<b>1,0</b>	3,8 - 4,3	4,3 - 5,7	5,7 - 8,7	8,7 - 22,8	> 22,8	> 22,8	22,8 - 8,7	
<b>1,25</b>	4,7 - 5,4	5,4 - 7,1	7,1 - 10,9	10,9 - 28,5	> 28,5	> 28,5	28,5 - 10,9	
<b>1,5</b>	5,7 - 6,5	6,5 - 8,5	8,5 - 13,0	13,0 - 34,2	> 34,2	> 34,2	34,2 - 13,0	
<b>1,75</b>	6,6 - 7,6	7,6 - 10,0	10,0 - 15,2	15,2 - 39,9	> 39,9	> 39,9	39,9 - 15,2	
<b>2,0</b>	7,6 - 8,7	8,7 - 11,4	11,4 - 17,4	17,4 - 45,6	> 45,6	> 45,6	45,6 - 17,4	
<b>2,5</b>	9,5 - 10,8	10,8 - 14,2	14,2 - 21,7	21,7 - 57,0	> 57,0	> 57,0	57,0 - 21,7	
<b>3,0</b>	11,4 - 13,0	13,0 - 17,1	17,1 - 26,0	26,0 - 68,4	> 68,4	> 68,4	68,4 - 26,0	

### TPI (Threads/Inch)

Right-hand/Left-hand Thread	For Right-hand Thread					For Left-hand Thread		
Lead Angle	4,5°	3,5°	2,5°	1,5°	0,5°	-0,5°	-1,5°	
Shim	External	YE3-3P	YE3-2P	YE3-1P	<b>YE3*</b>	YE3-1N	YE3-2N	YE3-3N
	Internal	YI3-3P	YI3-2P	YI3-1P	<b>YI3*</b>	YI3-1N	YI3-2N	YI3-3N
Shim Angle (Ti)	3°	2°	1°	0°	-1°	-2°	-3°	
TPI (Threads/Inch)	Effective Diameter (mm)							
<b>32</b>	3,0 - 3,3	3,3 - 4,6	4,6 - 6,9	6,9 - 18,0	> 18,0	> 18,0	18,0 - 6,9	
<b>28</b>	3,0 - 3,8	3,8 - 5,1	5,1 - 7,9	7,9 - 20,8	> 20,8	> 20,8	20,8 - 7,9	
<b>27</b>	3,6 - 4,1	4,1 - 5,3	5,3 - 8,1	8,1 - 21,3	> 21,3	> 21,3	21,3 - 8,1	
<b>24</b>	4,1 - 4,6	4,6 - 6,1	6,1 - 9,1	9,1 - 24,4	> 24,4	> 24,4	24,4 - 9,1	
<b>20</b>	4,8 - 5,6	5,6 - 7,1	7,1 - 10,9	10,9 - 29,0	> 29,0	> 29,0	29,0 - 10,9	
<b>18</b>	5,3 - 6,1	6,1 - 8,1	8,1 - 12,4	12,4 - 32,5	> 32,5	> 32,5	32,5 - 12,4	
<b>16</b>	5,8 - 6,9	6,9 - 8,9	8,9 - 13,7	13,7 - 35,8	> 35,8	> 35,8	35,8 - 13,7	
<b>14</b>	6,9 - 7,9	7,9 - 10,2	10,2 - 15,7	15,7 - 41,1	> 41,1	> 41,1	41,1 - 15,7	
<b>13</b>	7,4 - 8,4	8,4 - 11,2	11,2 - 17,0	17,0 - 44,7	> 44,7	> 44,7	44,7 - 17,0	
<b>12</b>	8,1 - 9,1	9,1 - 12,2	12,2 - 18,5	18,5 - 48,8	> 48,8	> 48,8	48,8 - 18,5	
<b>11,5</b>	8,4 - 9,7	9,7 - 12,4	12,4 - 19,3	19,3 - 50,3	> 50,3	> 50,3	50,3 - 19,3	
<b>11</b>	8,9 - 9,9	9,9 - 13,2	13,2 - 20,1	20,1 - 52,6	> 52,6	> 52,6	52,6 - 20,1	
<b>10</b>	9,7 - 10,9	10,9 - 14,5	14,5 - 22,1	22,1 - 57,9	> 57,9	> 57,9	57,9 - 22,1	
<b>9</b>	10,7 - 12,2	12,2 - 16,0	16,0 - 24,4	24,4 - 64,3	> 64,3	> 64,3	64,3 - 24,4	
<b>8</b>	11,9 - 13,7	13,7 - 18,0	18,0 - 27,7	27,7 - 72,4	> 72,4	> 72,4	72,4 - 27,7	

\* SSTE Type/SSTI Type holders are shipped with shims for a lead angle of  $Y_1 = 1,5^\circ$  (SSTE Type: **YE3**, SSTI Type: **YI3**).

Shims for lead angles of  $Y_1 = -1,5^\circ, -0,5^\circ, 0,5^\circ, 2,5^\circ, 3,5^\circ$ , and  $4,5^\circ$  are sold separately.

\* Shims are not needed for SSTI R1812M16 and SSTI R2016M16. (The holders are already provided with the standard holder inclination of  $1,5^\circ$ .)

Threading Holders

# Threading Tools

## SSTE / SSTI Type

### Shim Replacement

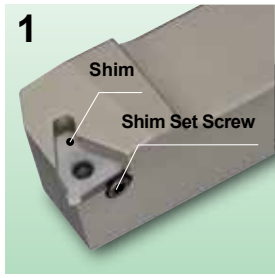
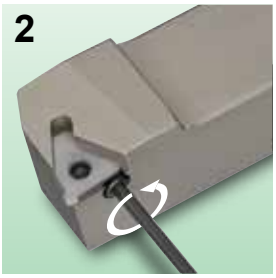
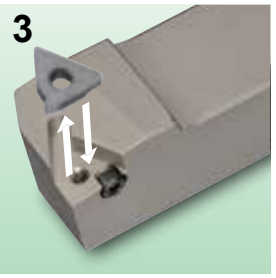
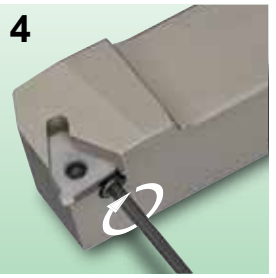
 <p><b>1</b></p> <p>Shim Shim Set Screw</p>	 <p><b>2</b></p>	 <p><b>3</b></p>	 <p><b>4</b></p>
<p>Remove the insert to expose the shim.</p>	<p>Loosen the shim set screw by one to two turns.</p>	<p>Remove the shim and attach a different shim that matches the lead.</p>	<p>Tighten the shim set screw (recommended tightening torque 1,0 to 1,5 Nm).</p>

### Wiper Flat

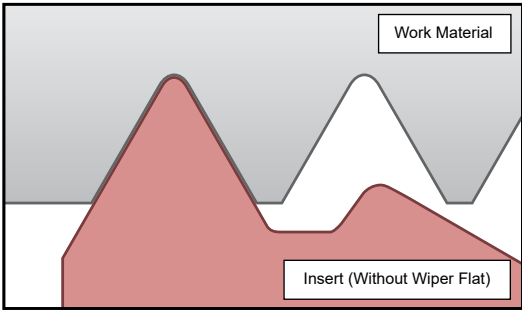
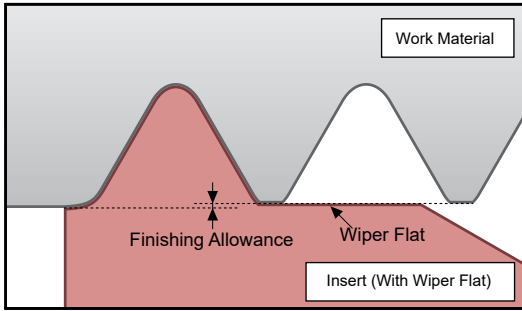
Without Wiper Flat	With Wiper Flat
 <p>Work Material</p> <p>Insert (Without Wiper Flat)</p>	 <p>Work Material</p> <p>Finishing Allowance</p> <p>Wiper Flat</p> <p>Insert (With Wiper Flat)</p>
<ul style="list-style-type: none"> <li>• Performs threading without machining thread ridges (the machined surface from the previous process is left unworked.)</li> <li>• Enables machining of threads with different pitch widths with the same insert</li> <li>• Finishing of the internal (or external) diameter is required before the threading process.</li> <li>• Fine burrs are easily formed on edges of ridges.</li> </ul>	<ul style="list-style-type: none"> <li>• Enables machining of workpieces into shapes compliant with thread standards</li> <li>• Only specific thread specifications and pitch can be machined</li> <li>• In order to finish a thread with the wiper flat, a finishing allowance of 0,1 mm on each side is required.</li> <li>• Edges of ridges can be rounded off.</li> </ul>

### Infeed Method

The modified flank infeed is recommended for the SSTE type/SSTI type.

This infeed method, which features reduced chip curl diameters and stable chip control, can also decrease chipping on trailing edges that often occurs in radial infeed machining. (1° is recommended for the modification angle.)

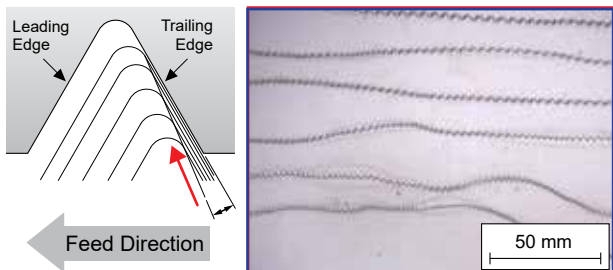
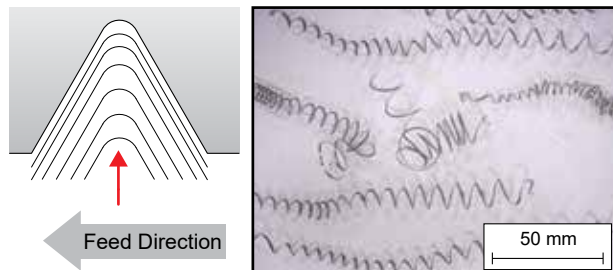
<p>● Impact of the Infeed Method on Chip Shapes</p> <p>Work Material: X5CrMo17-12-2, M30 x 1,5 Cutting Conditions: <math>v_c = 60</math> mm/min, wet, 8 Passes</p>	
<p><b>Modified Flank Infeed</b></p>  <p>Leading Edge</p> <p>Trailing Edge</p> <p>Feed Direction</p> <p>50 mm</p> <p>Reduced curl diameters ensure smooth, stable chip control (performance)</p>	<p><b>Radial Infeed Machining</b></p>  <p>Feed Direction</p> <p>50 mm</p> <p>Large curl diameters cause unstable chip control.</p>

# Threading Tools

## SSTE Type

### ■ SSTE Type Guidelines for Depth of Cut

External Metric Threads (Depth of cut per pass: mm)

Pitch (mm)	0,75	1,00	1,25	1,50	1,75	2,00	2,50	3,00
Overall Depth of Cut (mm)	0,48	0,64	0,80	0,92	1,10	1,26	1,57	1,87
No. of Passes	4	5	7	8	10	12	14	16
1	0,24	0,25	0,25	0,28	0,28	0,30	0,38	0,40
2	0,12	0,15	0,15	0,15	0,15	0,16	0,19	0,22
3	0,07	0,11	0,12	0,12	0,12	0,13	0,15	0,15
4	0,05	0,08	0,09	0,10	0,10	0,10	0,10	0,13
5		0,05	0,08	0,09	0,10	0,09	0,10	0,12
6			0,06	0,07	0,09	0,09	0,09	0,10
7			0,05	0,06	0,08	0,08	0,09	0,10
8				0,05	0,07	0,07	0,08	0,09
9					0,06	0,07	0,08	0,09
10					0,05	0,06	0,07	0,08
11						0,06	0,07	0,08
12						0,05	0,06	0,07
13							0,06	0,07
14							0,05	0,06
15								0,06
16								0,05

External Unified Threads (Depth of cut per pass: mm)

Threads/Inch	32	28	24	20	18	16	14	13	12	11	10	9	8
Overall Depth of Cut (mm)	0,50	0,57	0,67	0,80	0,89	1,00	1,15	1,23	1,34	1,46	1,60	1,78	2,00
No. of Passes	4	4	5	7	8	10	11	12	12	14	14	16	16
1	0,24	0,25	0,25	0,26	0,26	0,28	0,28	0,30	0,30	0,30	0,38	0,38	0,40
2	0,14	0,17	0,19	0,15	0,15	0,15	0,15	0,18	0,18	0,18	0,20	0,20	0,25
3	0,07	0,10	0,12	0,10	0,12	0,10	0,12	0,13	0,13	0,13	0,15	0,13	0,19
4	0,05	0,05	0,06	0,09	0,10	0,09	0,10	0,10	0,12	0,12	0,12	0,12	0,16
5			0,05	0,08	0,08	0,08	0,10	0,08	0,11	0,11	0,10	0,11	0,14
6				0,07	0,07	0,07	0,09	0,08	0,10	0,10	0,09	0,10	0,12
7				0,05	0,06	0,07	0,08	0,07	0,09	0,08	0,09	0,10	0,11
8					0,05	0,06	0,07	0,07	0,08	0,08	0,08	0,09	0,10
9						0,05	0,06	0,06	0,07	0,07	0,08	0,09	0,09
10						0,05	0,05	0,06	0,06	0,07	0,07	0,08	0,08
11							0,05	0,05	0,05	0,06	0,07	0,08	0,07
12								0,05	0,05	0,06	0,06	0,07	0,07
13										0,05	0,06	0,07	0,06
14										0,05	0,05	0,06	0,06
15												0,05	0,05
16												0,05	0,05

No. of passes and depths of cut in the table above are general guidelines only. Increase or decrease depending on conditions. However, the maximum depth of cut should be kept to 0,5mm or less.

When using an insert with a wiper flat, add machining allowance to the total depth of cut.

### ■ Recommended Cutting Conditions

Work Material	<b>P</b> Carbon Steel	<b>P</b> Alloy Steel (up to 330HB)	<b>M</b> Stainless Steel	<b>K</b> Grey Cast Iron (up to 330HB)	<b>K</b> Ductile Cast Iron	<b>S</b> Titanium Alloy
Cutting Speed $v_c$ (m/min)	75–150	75–135	60–120	90–180	75–135	24–90



### ■ SSTI Type Guidelines for Depth of Cut

#### Internal Metric Threads (Depth of cut per pass: mm)

Pitch (mm)	0,75	1,00	1,25	1,50	1,75	2,00	2,50	3,00
Overall Depth of Cut (mm)	0,49	0,58	0,74	0,89	1,04	1,18	1,47	1,76
No. of Passes	4	5	8	10	11	12	14	16
1	0,20	0,22	0,22	0,25	0,25	0,25	0,30	0,30
2	0,12	0,14	0,14	0,12	0,17	0,18	0,19	0,20
3	0,12	0,10	0,09	0,08	0,10	0,12	0,15	0,17
4	0,05	0,07	0,07	0,08	0,08	0,10	0,12	0,14
5		0,05	0,06	0,07	0,08	0,09	0,10	0,12
6			0,06	0,07	0,07	0,08	0,09	0,11
7			0,05	0,06	0,07	0,07	0,08	0,10
8			0,05	0,06	0,06	0,07	0,08	0,10
9				0,05	0,06	0,06	0,07	0,08
10				0,05	0,05	0,06	0,07	0,08
11					0,05	0,05	0,06	0,07
12						0,05	0,06	0,07
13							0,05	0,06
14							0,05	0,06
15								0,05
16								0,05

#### Internal Unified Threads (Depth of cut per pass: mm)

Threads/Inch	32	28	24	20	18	16	14	13	12	11	10	9	8
Overall Depth of Cut (mm)	0,43	0,49	0,57	0,69	0,76	0,86	0,98	1,06	1,15	1,25	1,37	1,53	1,72
No. of Passes	4	4	5	7	8	10	11	12	12	14	14	16	16
1	0,20	0,20	0,20	0,22	0,22	0,22	0,25	0,25	0,27	0,27	0,27	0,30	0,30
2	0,10	0,16	0,16	0,12	0,13	0,13	0,15	0,15	0,16	0,16	0,18	0,18	0,22
3	0,08	0,08	0,09	0,09	0,10	0,08	0,10	0,10	0,12	0,12	0,16	0,16	0,18
4	0,05	0,05	0,07	0,08	0,08	0,08	0,08	0,08	0,10	0,10	0,12	0,11	0,15
5			0,05	0,07	0,07	0,07	0,07	0,08	0,09	0,08	0,10	0,09	0,12
6				0,06	0,06	0,07	0,07	0,07	0,08	0,08	0,09	0,09	0,11
7				0,05	0,05	0,06	0,06	0,07	0,07	0,07	0,08	0,08	0,10
8					0,05	0,06	0,06	0,06	0,06	0,07	0,07	0,08	0,09
9						0,05	0,05	0,06	0,06	0,06	0,06	0,07	0,08
10						0,04	0,05	0,05	0,05	0,06	0,06	0,07	0,07
11							0,04	0,05	0,05	0,05	0,05	0,06	0,06
12								0,04	0,04	0,05	0,05	0,06	0,06
13										0,04	0,04	0,05	0,05
14										0,04	0,04	0,05	0,05
15												0,04	0,04
16												0,04	0,04

No. of passes and depths of cut in the table above are general guidelines only. Increase or decrease depending on conditions. However, the maximum depth of cut should be kept to 0,5 mm or less.

When using an insert with a wiper flat, add machining allowance to the total depth of cut.

### ■ Recommended Cutting Conditions

Work Material	<b>P</b> Carbon Steel	<b>P</b> Alloy Steel (up to 330HB)	<b>M</b> Stainless Steel	<b>K</b> Grey Cast Iron (up to 330HB)	<b>K</b> Ductile Cast Iron	<b>S</b> Titanium Alloy
Cutting Speed $v_c$ (m/min)	75–150	75–135	60–120	90–180	75–135	24–90





# Milling Cutters

G1-G86

# G



	Selection Guide	<b>Milling Cutter Selection Guide</b> .....	G 2-3
	ISO	<b>Milling Insert Identification Table</b> .....	G 4-5
<b>Face Milling</b>	"Sumi Dual Mill", General Purpose Face Mills <small>Expansion</small>	DGC (M/F) 13000 .....	G 6-9
	"Wave Mill", General Purpose Face Mills <small>Expansion</small>	WGX (M/F) 13000 .....	G10-11
		UFO (F) 4000/5000 .....	G12-13
<b>Multi Purpose Milling</b>	"Wave Radius Mill" with Polygon Inserts with Round Inserts	DNX (F) 12000 .....	G14-15
		WRCX (F) 12000/16000/20000 .....	G16-17
		RSX .....	G18-19
		RSX (F) 10000/12000/16000/20000.....	G20-21
<b>Shoulder Milling</b>	"Sumi Dual Mill" <small>Expansion</small>	DFC 09000 .....	G22-25
	"Wave Mill" for Shoulder Milling <small>Expansion</small>	WFX .....	G26-27
		WFX (M/F) 08000 .....	G28
		WFX (F) 12000 .....	G29
	"Sumi Dual Mill", tangential <small>Expansion</small>	TSX .....	G30-31
		TSX (F) 08000 .....	G34
		TSX (M) 13000 .....	G35-36
		TSX (F) 13000..... <small>New</small>	G37
	Sumi Dual Mill" Repeater Mill	TSXR 08000/13000.....	G38-39
	Wave Mill" for Shoulder Milling <small>Expansion</small>	WEZ .....	G40-47
		WEZ 11000/17000.....	G48-51
	"Wave Mill" Repeater Mill	WEZR <small>New</small> .....	G52-53
		WEZR 11000/17000 .....	G54-57
	"Wave Mill" for Shoulder Milling Repeater Mill	WEX (F) 1000/2000/3000.....	G58
		WRX (F) .....	G59
<b>Others</b>	Shoulder Milling Cutter for Titanium	MTIX <small>New</small> .....	G60-62
	"Sumi Dual Mill", High Feed Milling	DMSW <small>New</small> .....	G63-65
		DMSW 80000 .....	G66
	High Feed Milling	MSX 08000/12000/14000.....	G67
	High Feed Milling <small>Expansion</small>	WFXH .....	G68-69
		WFXH 08000/12000 .....	G70-71
	"Wave Mill" Series for Aluminium	WAX 3000 .....	G72
		WAX 4000 .....	G73
	High Speed Non-Ferrous Milling <small>Expansion</small>	ANX .....	G74-77
		ANXS/ANXA 16000 .....	G78-81
	Aluminium Milling	SUMIDIA "RF" .....	G82
		SUMIDIA "SRF".....	G83
	Grey Cast Iron Milling	SUMIBORON "BN Finish Mill" FMU .....	G84-85

Milling Cutters





# Milling Insert ISO Identification Table

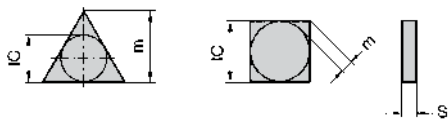
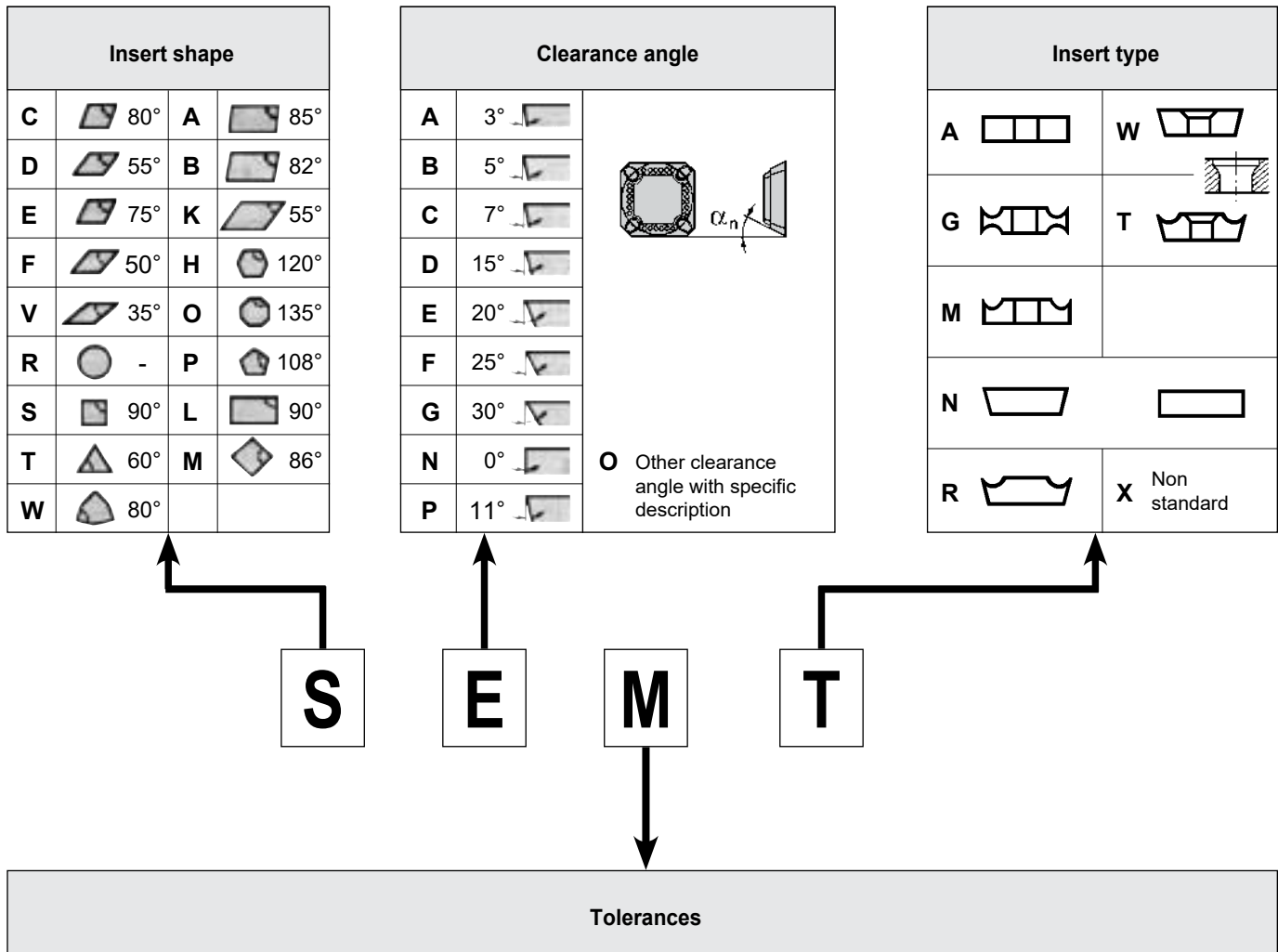

Class	Tolerances (mm)		
	m	IC	s
A	±0,005	±0,025	±0,025
F	±0,005	±0,013	±0,025
C	±0,013	±0,025	±0,025
H	±0,013	±0,013	±0,025
E	±0,025	±0,025	±0,025
G	±0,025	±0,025	±0,13

Class	Tolerances (mm)		
	m	IC	s
J	±0,005	±0,05 – ±0,13*	±0,025
K	±0,013	±0,05 – ±0,13*	±0,025
L	±0,025	±0,05 – ±0,13*	±0,025
M	±0,08~ ±0,18*	±0,05 – ±0,13*	±0,13
N	±0,08~ ±0,18*	±0,05 – ±0,13*	±0,025
U	±0,13~ ±0,38*	±0,08 – ±0,25*	±0,13

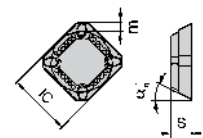

\* The tolerance is dependent upon the insert size of IC. See tables below.

Tolerance class for dimension m

m	S	T	C	W	V	D
6,35		±0,08			-	±0,11
9,525		±0,08			±0,13	±0,11
12,7		±0,13				±0,15
15,875		±0,15				±0,18
19,05		±0,15				±0,18
25,4		±0,18				

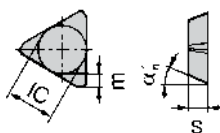

Tolerance class for dimension IC

IC	S	T	C	D	V	W	R
6,35			±0,05				
9,525			±0,05				±0,05
12,7			±0,08				±0,08
15,875			±0,10				±0,10
19,05			±0,10				±0,10
25,4			±0,13				±0,10

# Milling Insert ISO Identification Table

**Thickness**

**02** s = 2,38 mm  
**03** s = 3,18  
**T3** s = **3,97**  
**04** s = 4,76  
**05** s = 5,56  
**06** s = 6,35  
**07** s = 7,94  
**09** s = 9,52

**Corner geometry with wiper flat**

**Entering angle**

**A** 45°  
**D** 60°  
**E** 75°  
**F** 85°  
**P** 90°  
**Z** - Others

1. Major cutting edge  
 2. Chamfered corner  
 3. Wiper flat  
 4. Side cutting edge

**Clearance angle on wiper flat**

**A** 3°  
**B** 5°  
**C** 7°  
**D** 15°  
**E** 20°  
**F** 25°  
**G** 30°  
**N** 0°  
**P** 11°  
**Z** - Others

**Radius**

**02** r = 0,2 mm  
**04** r = 0,4  
**08** r = 0,8  
**12** r = 1,2  
**16** r = 1,6  
**20** r = 2,0  
**24** r = 2,4

**M0** - Round insert (metric)  
**00** - Round insert (inch)

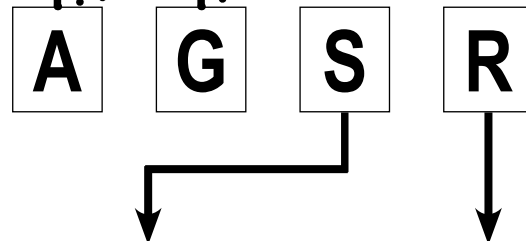
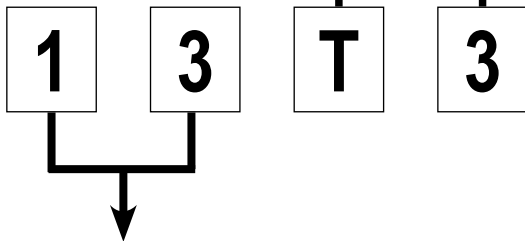

Insert size Symbol and cutting edge length (mm)							
IC d (mm)	C C (mm)	D D (mm)	R R (mm)	S S (mm)	T T (mm)	V V (mm)	W W (mm)
3,97					06 (6,9)		
4,76					08 (8,2)		
5,0			05 (5,0)				
5,56					09 (9,6)	09 (9,7)	03 (3,8)
6,0			06 (6,0)				
6,35	06 (6,4)	07 (7,7)		06 (6,35)	11 (11,0)	11 (11,1)	04 (4,3)
7,94	08 (8,0)			07 (7,94)			05 (5,4)
8,0			08 (8,0)				
9,525	09 (9,7)	11 (11,6)	09 (9,525)	09 (9,525)	16 (16,5)	16 (16,6)	06 (6,5)
10			10 (10,0)				
12			12 (12,0)				
12,7	12 (12,9)	15 (15,5)	12 (12,7)	12 (12,7)	22 (22,0)		08 (8,7)
15,875	16 (16,1)	19 (19,4)	15 (15,875)	15 (15,875)	27 (27,5)		10 (10,9)
16			16 (16,0)				
19,05	19 (19,3)		19 (19,05)	19 (19,05)	33 (33,0)		
20			20 (20,0)				
25			25 (25,0)				
25,4			25 (25,4)	25 (25,4)			
31,75			31 (31,75)	31 (31,75)			
32			32 (32,0)				

**Cutting edge condition**

**F** Sharp

**E** Rounded

**T** Chamfered

**S** Rounded and chamfered

**Feed direction**

Right hand

Neutral

Left hand



# "Sumi Dual Mill" DGC (M/F) Type

Expansion



## General Features

Sumi Dual Mill DGC type utilizes double-sided inserts for excellent economy. This is a general-purpose cutter featuring high cutting edge strength for high efficiency milling and low-burr chipbreaker design that provides high quality machined surface.

The DGC type insert lineup includes double-sided SNMU / SNEU and ONMU / ONEU types. Up to 16 corners can be used for improved economy.

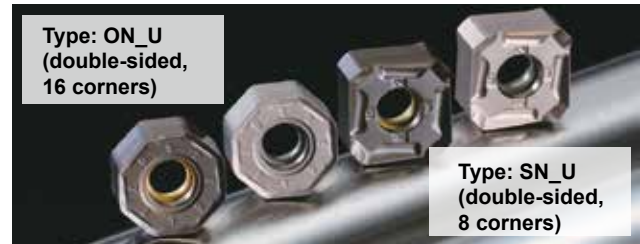

## Characteristics

- Same cutting performance as single-sided inserts plus superior economy.
- Achieves level of cutting edge sharpness and machined surface quality equivalent to single-sided cutter at a maximum cutting depth of  $a_p \leq 3$  mm.

## Recommended Cutting Conditions for General Steel Milling

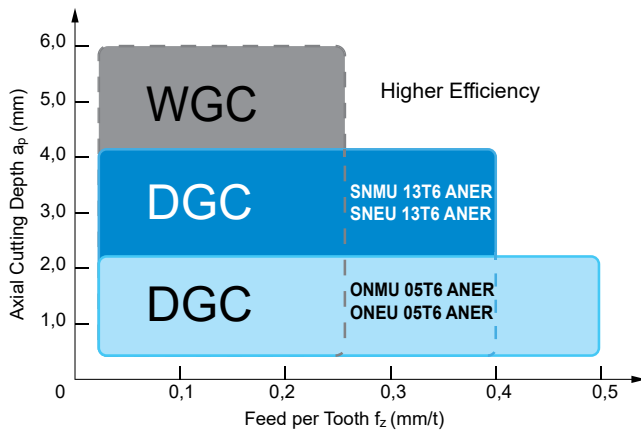

## Cutting Force Comparison

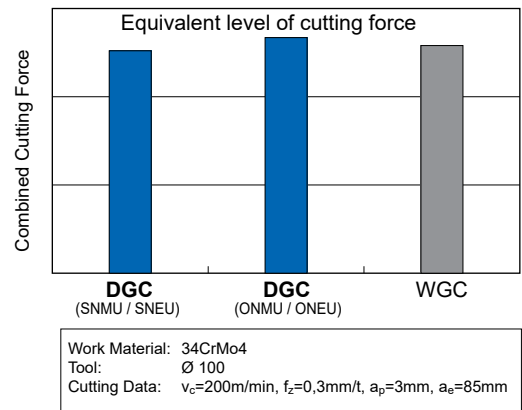

## Dual-Purpose Body

Two types of inserts can be used with a single body depending on milling application to help reduce costs. Stronger than single-sided cutters.



- first recommendation
- economical double-sided design offers 8 cutting edges with SN\_U inserts
- maximum depth of cut:  $a_p = 6$  mm



Use two types of inserts for different applications.





- double-sided design with 16 corners for improved economy
- maximum depth of cut:  $a_p = 3$  mm

# "Sumi Dual Mill" DGC (M/F) Type

## Line-up

Choose a tool that fits your application from a comprehensive line-up

Cat. No	DGC 13000 RS	DGCM 13000 RS	DGCF 13000 RS	DGC 13000 EW
Type	Standard pitch	Medium pitch	Fine pitch	Endmill type
Cutter Diameter	Ø 40 mm – Ø 250 mm	Ø 50 mm – Ø 250 mm	Ø 50 mm – Ø 250 mm	Ø 40 mm – Ø 63 mm
Cutting Edges	3–10	4–14	5–18	3–4
Shape				 → H6

## High Reliability

Employs New Super ZX Coating, a multi-layer PVD coating grade and CVD coating grade with enhanced coating strength provided by newly developed stress control technology. Improved run-out precision reduces tool life deviation to achieve highly reliable tool life.

## Multi-layer PVD Coating

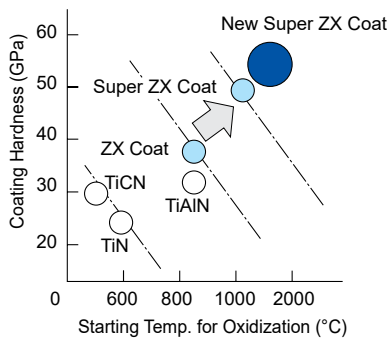

## Wear Resistance

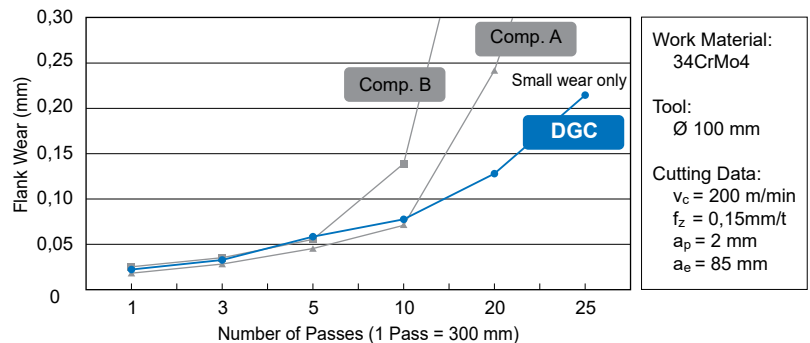



## Cutter Diameter and Cutter Body Height

Insert: SN\_U 13T6 ANER (square)

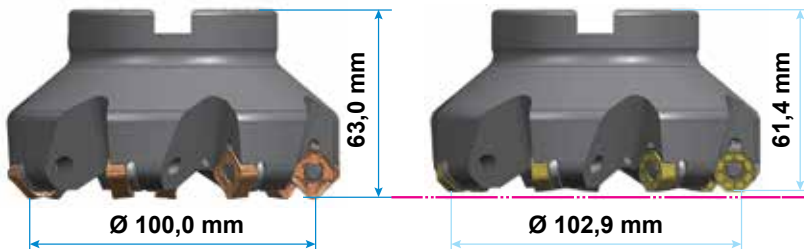
Insert: ON\_U 05T6 ANER (octagonal)



Example: DC = 100mm	Number of Cutting Edges	Tool Diameter (mm)	Cutter Height (mm)	Max. Depth of Cut (mm)
SNMU/SNEU 	8	100,0	63,0	6,0
ONMU/ONEU 	16	102,9	61,4	3,0

Square inserts (SNMU/SNEU) and octagonal inserts (ONMU/ONEU) can be used interchangeably on the same body. Using these inserts the cutter will have different cutter diameter and cutter body height.

# "Sumi Dual Mill" DGC (M/F) Type

General Milling of Steel and Cast Iron

## Body – Shell type

Rake Angle	Radial	-10°
	Axial	-5°

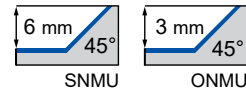

Fig. 1

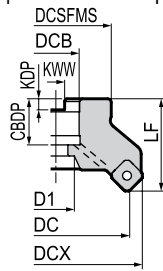

Fig. 2

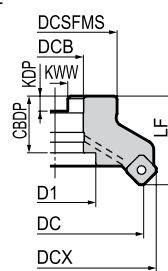

Fig. 3

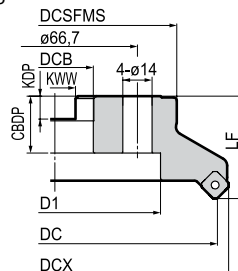
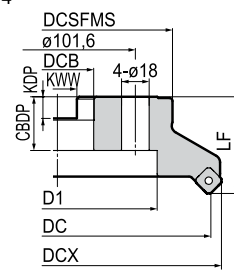

Fig. 4



Cutter body  $\phi$  DC  $\geq$  160 mm: no inner coolant

## Body

### ● Type: DGC, Standard Pitch

Cat. No.	Stock	Dimension (mm)									No. of Teeth	Weight (kg)	Fig.
		DC	DCX	DCSFMS	LF	DCB	D1	KWW	KDP	CBDP			
DGC 13040 RS	○	40 (42,90)	54	36	40 (38,44)	16	13,5	8,4	5,6	18	3	0,3	1
13050 RS	●	50 (52,90)	64	40	40 (38,44)	22	18,0	10,4	6,3	20	3	0,4	1
13063 RS	●	63 (65,90)	77	50	40 (38,44)	22	18,0	10,4	6,3	20	4	0,5	1
13080 RS	●	80 (82,90)	94	60	50 (48,44)	27	20,0	12,4	7,0	25	4	1,2	1
DGC 13100 RS	●	100 (102,90)	114	70	50 (48,44)	32	46,0	14,4	8,5	32	5	1,6	2
13125 RS	●	125 (127,90)	139	80	63 (61,44)	40	52,0	16,4	9,5	29	6	2,8	1
13160 RS	○	160 (162,90)	174	130	63 (61,44)	40	88,0	16,4	9,5	29	7	4,5	3
DGC 13200 RS	○	200 (202,90)	214	150	63 (61,44)	60	130,0	25,7	14,0	35	8	7,1	4
13250 RS	○	250 (252,90)	264	190	63 (61,44)	60	160,0	25,7	14,0	35	10	11,2	4

### ● Type: DGCM, Medium Pitch

Cat. No.	Stock	Dimension (mm)									No. of Teeth	Weight (kg)	Fig.
		DC	DCX	DCSFMS	LF	DCB	D1	KWW	KDP	CBDP			
DGCM 13050 RS	●	50 (52,90)	64	40	40 (38,44)	22	18	10,4	6,3	20	4	0,3	1
13063 RS	●	63 (65,90)	77	50	40 (38,44)	22	18	10,4	6,3	20	5	0,5	1
13080 RS	●	80 (82,90)	94	60	50 (48,44)	27	20	12,4	7,0	25	6	1,1	1
DGCM 13100 RS	●	100 (102,90)	114	70	50 (48,44)	32	46	14,4	8,5	32	7	1,5	2
13125 RS	●	125 (127,90)	139	80	63 (61,44)	40	52	16,4	9,5	29	8	2,8	1
13160 RS	●	160 (162,90)	174	130	63 (61,44)	40	88	16,4	9,5	29	10	4,6	3
DGCM 13200 RS	○	200 (202,90)	214	150	63 (61,44)	60	130	25,7	14,0	35	12	7,0	4
13250 RS	○	250 (252,90)	264	190	63 (61,44)	60	160	25,7	14,0	35	14	11,1	4

### ● Type: DGCF, Fine Pitch

Cat. No.	Stock	Dimension (mm)									No. of Teeth	Weight (kg)	Fig.
		DC	DCX	DCSFMS	LF	DCB	D1	KWW	KDP	CBDP			
DGCF 13050 RS	●	50 (52,90)	64	40	40 (38,44)	22	18	10,4	6,3	20	5	0,3	1
13063 RS	●	63 (65,90)	77	50	40 (38,44)	22	18	10,4	6,3	20	6	0,5	1
13080 RS	●	80 (82,90)	94	60	50 (48,44)	27	20	12,4	7,0	25	8	1,1	1
DGCF 13100 RS	●	100 (102,90)	114	70	50 (48,44)	32	46	14,4	8,5	32	10	1,4	2
13125 RS	●	125 (127,90)	139	80	63 (61,44)	40	52	16,4	9,5	29	12	2,7	1
13160 RS	●	160 (162,90)	174	130	63 (61,44)	40	88	16,4	9,5	29	14	4,4	3
DGCF 13200 RS	○	200 (202,90)	214	150	63 (61,44)	60	130	25,7	14,0	35	16	6,9	4
13250 RS	○	250 (252,90)	264	190	63 (61,44)	60	160	25,7	14,0	35	18	11,0	4

( ) Figures in brackets indicate values for ONMU inserts.  
Inserts are not included.

## Identification Details

<b>DGC</b>	<b>M</b>	<b>13</b>	<b>050</b>	<b>R</b>	<b>S</b>
Cutter Series	M: Medium F: Fine	Insert Size	Cutter Diameter	Direction	Metric

● = Euro stock  
○ = Japan stock

Recommended Tightening Torque (N·m)

## Inserts

Dimensions (mm)

Application	Coated Carbide								Cermets		
	ACU2500	XCU2500	ACP100	ACP200	ACP300	XCK2000	ACK200	ACK300		ACM200	ACM300
High Speed/Light cut	SM	PM	P			K	K		MS		PM
General Purpose	SM	PM		PM	M	K	K		MS		P
Roughing	SM			PM	PM			K		MS	
Cat. No.	ACU2500	XCU2500	ACP100	ACP200	ACP300	XCK2000	ACK200	ACK300	ACM200	ACM300	T4500A
Fig.											
SNMU 13T6ANER L	●	○	●	●	●	○	●	●			
13T6ANER G	●	○	●	●	●	○	●	●			
13T6ANER H	●	○	●	●	●	○	●	●			
13T6ANER FL	●	○	●	●	●	○	●	●			
13T6ANER FG	●	○	●	●	●	○	●	●			
SNEU 13T6ANER L									●	●	
13T6ANER G									●	●	
13T6ANER FL									○	○	
13T6ANER FG									○	○	
XNEU 13T6ANEN W	●	○		●		○		●			●
ONMU05T6ANER L	●	○	●	●	●	○	●	●			
05T6ANER G	●	○	●	●	●	○	●	●			
ONEU 05T6ANER L									●	●	
05T6ANER G									●	●	

Fig. 1

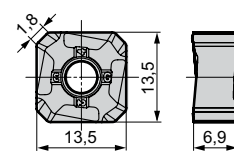

Fig. 2

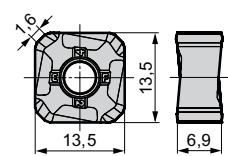

Fig. 3

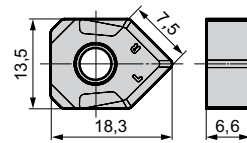
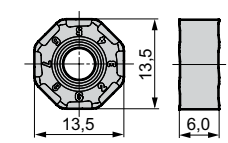
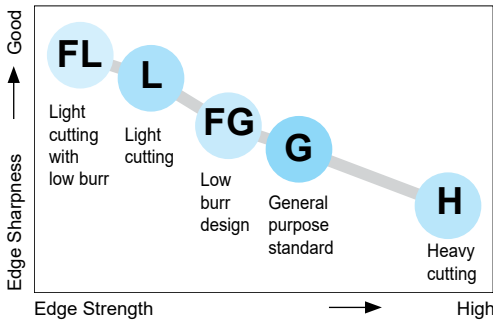

Fig. 4



## Chipbreaker



## Improved Milling Quality

FG type chipbreakers feature chamfer to minimize burrs and provide excellent milling quality.

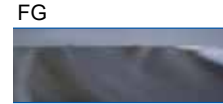
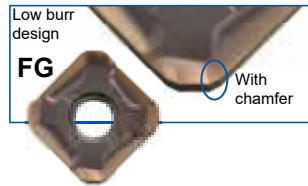

FG type inserts with low-burr design enable high-quality milling with few burrs and little edge chipping.

Milling Cutters

## Attaching Inserts



## Octagonal Inserts

Firmly align insert with supporting face, press down in the direction of the arrow and tighten the screw to fix the insert.

Press down firmly from above

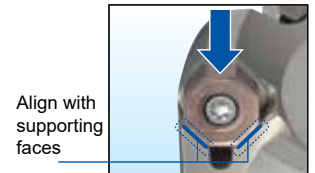

## Spare Parts

Shim	Shim Screw	L Seat Wrench	Insert Screw	Insert Wrench
DGCS13R	BW0609F	LH040	BFTX0412IP 3.0mm	TRDR15IP

## Optional

Insert Screw (*)
BFTX0418IP

\*Corners can be changed simply by loosening the screw. (Only suitable for DGC/DGCM types with body size ≥ Ø 80 mm).

## Recommended Cutting Conditions (SN\_U)

ISO	Work Material	Hardness (HB)	Cutting Speed $v_c$ (m/min)	Feed Rate $f_z$ (min/t)	Depth of Cut (mm)	Grade
P	General Steel	180-280	150-200-250	0,10-0,25-0,40	<4	ACU2500
	Alloyed Steel	≤180	180-250-350	0,10-0,30-0,45	<4	ACP200 ACP300
	Die Steel	200-220	100-150-200	0,15-0,25-0,35	<4	XCU2500
M	Stainless Steel	-	160-200-250	0,15-0,23-0,30	<3	ACU2500 ACM300
K	Cast Iron	250	100-200-250	0,10-0,25-0,40	<5	ACU2500 ACK200 ACK300 XCU2500 XCK2000
S	Exotic Steel	-	30-50-80	0,10-0,20-0,30	<3	ACU2500 ACM200 ACM300

Min. - Optimum - Max.

## Recommended Cutting Conditions (ON\_U)

ISO	Work Material	Hardness (HB)	Cutting Speed $v_c$ (m/min)	Feed Rate $f_z$ (min/t)	Depth of Cut (mm)	Grade
P	General Steel	180-280	150-200-250	0,10-0,30-0,50	<2	ACU2500
	Alloyed Steel	≤180	180-250-350	0,10-0,50-0,50	<2	ACP200 ACP300
	Die Steel	200-220	100-150-200	0,15-0,25-0,30	<2	XCU2500
M	Stainless Steel	-	160-200-250	0,15-0,23-0,30	<2	ACU2500 ACM300
K	Cast Iron	250	100-200-250	0,10-0,30-0,50	<2	ACU2500 ACK200 ACK300 XCU2500 XCK2000
S	Exotic Steel	-	30-50-80	0,10-0,20-0,30	<2	ACU2500 ACM200 ACM300





# "Wave Face Mill" WGX (M/F) Type



## General Features

The Wavemill WGX Type employs unique chipbreaker design to provide lower cutting resistance and higher quality surface finishes than conventional tools.

## Series

Type	Cat. No.	Cutter	No. of Teeth
Standard Pitch	WGX 13000RS	Ø 40 – Ø 250	3–10
Medium Pitch	WGXM 13000RS	Ø 50 – Ø 250	4–14
Fine Pitch	WGXF 13000RS	Ø 50 – Ø 250	5–24
Endmill Type	WGX 13000EW	Ø 32 – Ø 63	3–5

Inner coolant available for DC ≤ Ø 125 mm

## Characteristics

- **Stable Cutting**  
Special chipbreaker designed for WGX enables lower cutting forces. → H7
- **High Quality**  
Improved run-out precision and unique wiper edge shape ensure excellent surface finish quality. Optimised chamfer edge reduces burr and edge chipping.
- **Long Tool Life**  
Features high precision technology that reduces insert run-out variation and a new coating to provide stable and long tool life.

## Insert Shape Characteristics

Unique wiper edge shape for improved surface roughness

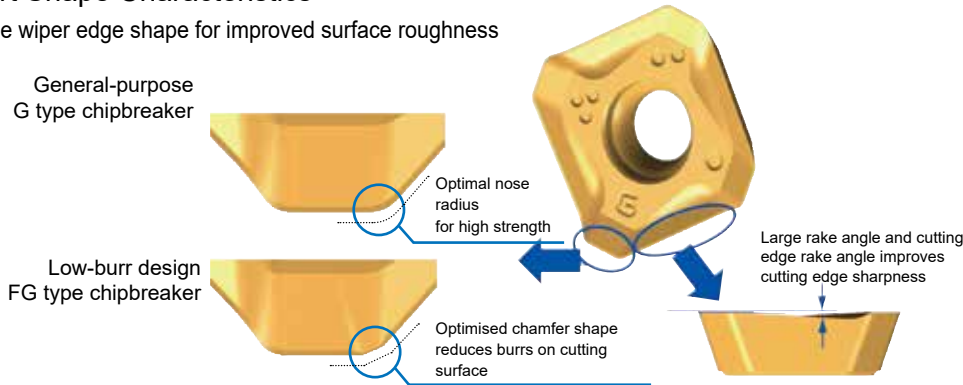

## Inserts

Application	Coated Carbide										Carb.	DLC	Cermets
	P	PM	P	PM	M	K	K	MS	MS	MS			
High Speed/Light Cut	●	●	●	●	●	●	●	●	●	●	●	●	●
General Purpose	●	●	●	●	●	●	●	●	●	●	●	●	●
Roughing	●	●	●	●	●	●	●	●	●	●	●	●	●
Cat. No.	ACU2500	XCU2500	ACP100	ACP200	ACP300	XCK2000	ACK200	ACK300	ACM200	ACM300	H1	DL 1000	T4500A
SEET 13T3AGFR-L	●	○	●	●	●	○	●	●	●	●	○	○	1
SEET 13T3AGSR-L	●	○	●	●	●	○	●	●	●	●	○	○	1
SEET 13T3AGSR-G	●	○	●	●	●	○	●	●	●	●	○	○	1
SEMT 13T3AGSR-L	●	○	●	●	●	○	●	●	●	●	○	○	1
SEMT 13T3AGSR-G	●	○	●	●	●	○	●	●	●	●	○	○	1
SEMT 13T3AGSR-H	●	○	●	●	●	○	●	●	●	●	○	○	1
SEMT 13T3AGSR-FG	●	○	●	●	●	○	●	●	●	●	○	○	2
XEEW 13T3AGER-WR	●	○	○	○	○	○	○	○	○	○	○	○	3

Dimensions (mm)

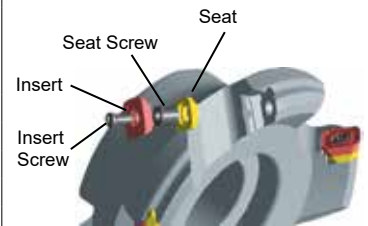
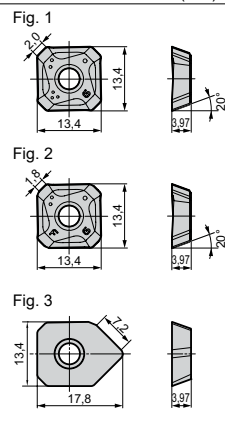

## Spare Parts

Applicable Cutters	Shim	Shim Screw	Insert Screw	Insert Wrench	Seat Wrench
WGX (-M/F)	WGCS 13 R	BW 0507 F	BFTX 03512 IP	TRDR 15 IP	LH 035

## Recommended Cutting Conditions

ISO	Work Material	Hardness (HB)	Cutting Speed $v_c$ (m/min)	Feed Rate $f_z$ (mm/tooth)	Grade
P	General Steel	180–280	150–200–250	0,15–0,20–0,25	ACU2500
	Soft Steel	≤180	180–265–350	0,10–0,25–0,40	ACP200
	Die Steel	200–220	100–150–200	0,15–0,20–0,25	XCU2500
M	Stainless Steel	-	160–205–250	0,15–0,23–0,30	ACU2500
K	Cast Iron	250	100–175–250	0,15–0,23–0,30	ACM300
					ACU2500
N	Non Ferrous Alloy	-	500–750–1000	0,15–0,23–0,30	ACK200
S	Exotic Alloy	-	30–50–80	0,10–0,20–0,30	XCK2000
					DL1000
					ACU2500
					ACM300

Minimum-Optimum-Maximum



# Face Mill

## UFO / UFOF Type

General Milling for Steel, Cast Iron & Exotic Material



### Specifications

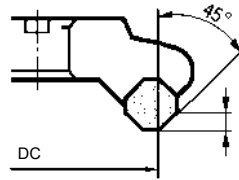

Approach angle: 45°  
 Axial rake angle: + 27°  
 Radial rake angle: - 7°  
 (-10° for ø 50 and ø 63)  
 max depth of cut: 5,0 mm (UFO 4000 type)  
 7,0 mm (UFO 5000 type)

### Body

Cat. No.	Stock		Dimensions (mm)								No. of Teeth	Max. Depth of Cut	Weight (Kg)	Fig.
	R	L	DC	DCX	DCSFMS	LF	DCB	KWW	KDP	CBDP				
UFO 4050 R/L-S	●		50	74	45	50	22	10,4	6,3	20	4	5,0	1,3	1
4063 R/L-S	●		63	86	50	50	22	10,4	6,3	20				
4080 R/L-S	●		80	103	60	50	27	12,4	7,0	25				
UFO 4100 R/L-S	●	●	100	122	75	50	32	14,4	8,5	29				
4125 R/L-S	●		125	146	75	63	40	16,4	9,5	29				
4160 R/L-S	●		160	180	100	63	40	16,4	9,5	29	9	7,0	6,6	3
UFO 4200 R/L-S	●		200	220	130	63	60	25,7	14,0	32				
4250 R/L-S	□		250	270	300	63	60	25,7	14,0	40				
UFO 4315 R/L-S	□		315	335	240	80	60	25,7	14,0	40				
UFO 5080 R/L-S	□		80	102	60	50	27	12,4	7,0	25				
UFO 5100 R/L-S	●		100	119	75	50	32	14,4	8,5	29	6	7,0	2,9	2
5125 R/L-S	●		125	143	75	63	40	16,4	9,5	29				
5160 R/L-S	●		160	177	100	63	40	16,4	9,5	29				
UFO 5200 R/L-S	●		200	217	130	63	60	25,7	14,0	32				
5250 R/L-S	□		250	267	200	63	60	25,7	14,0	40				
UFO 5315 R/L-S	□		315	332	240	80	60	25,7	14,0	40	15	26,6	5	

Fig. 1

Fig. 2

Fig. 3

Fig. 4

Fig. 5

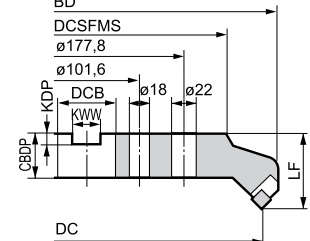
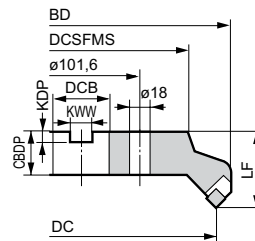
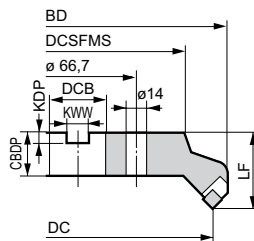
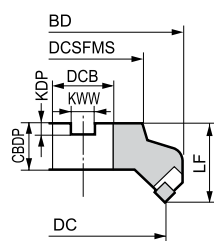
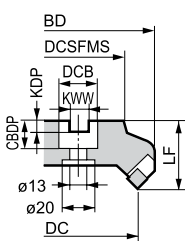

### Spare Parts

Cutter	Locator	Insert block	Insert clamp	
4050-4063	UF 4 K R/L	S-UF 4 S R/L	UFTW R/L	
4080-4315	UF 4 K R/L	UF 4 S R/L		
5080-5315	UF 5 K R/L	UF 5 S R/L		
Cutter	Locator clamp		Double screw	Wrench
4050-4063	UFWK R/L		WB 7-15 T	TT 25
4080-4315				
5080-5315				

### Structure

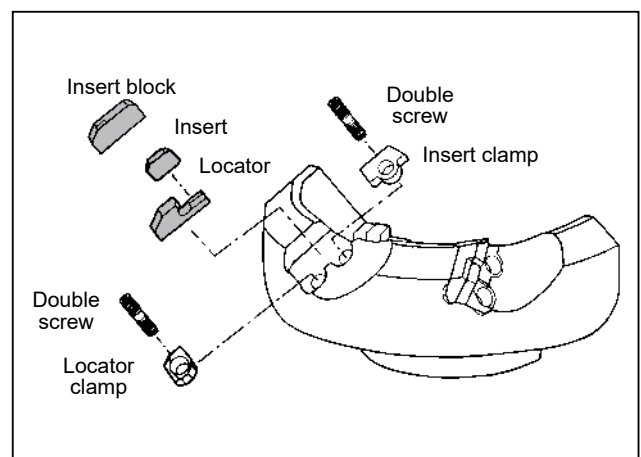

# Face Mill UFO / UFOF Type

## ■ Features

- 45° approach face mills
- 27° super high rake multi purpose cutter for outstanding productivity milling steels, irons and alloys
- Substantially improves metal removal rates on low powered machines
- Differential pitched inserts guarantee smooth cutting action
- Rigid body incorporates carbide locators and HSS shims resulting in extremely low run out



## ■ Body (Fine Pitch Type)

Cat. No.	Stock		Dimensions (mm)								No. of Teeth	Max. Depth of Cut	Weight (Kg)	Fig.
	R	L	DC	DCX	DCSFMS	LF	DCB	KWW	KDP	CBDP				
UFOF 4080 R/L-S	●		80	103	60	50	27	12,4	7,0	25	6	5,0	2,1	1
UFOF 4100 R/L-S	●		100	122	75	50	32	14,4	8,5	29	8		2,9	2
4160 R/L-S	●		160	180	100	63	40	16,4	9,5	29	12		6,6	3
UFOF 4200 R/L-S	□		200	220	130	63	60	25,7	14,0	32	16		9,5	4
4250 R/L-S	□		250	270	300	63	60	25,7	14,0	40	20		14,8	4
UFOF 4315 R/L-S	□		315	335	240	80	60	25,7	14,0	40	24	26,6	5	

## ■ Insert

Grade		Coated Carbide					Cermet	Uncoated Carbide				Dimensions (mm)		
High Speed/Light Cut		P			K									
General Purpose			P <sub>M</sub>	P <sub>M</sub>	K		P	P	K	K				
Roughing			P <sub>M</sub>	P <sub>M</sub>	K									
Cat. No.		ACP100	ACP200	ACP300	ACK200	ACK300	T250A	A30N	G10E	H1	H10E	Fig.		
UFO(F) 4000	SFKN 12T3 AZFN				●	●			●	●		1(2)	Fig. 1 (Grades: ACP_, ACK_) 	
	12T3 AZTN	●	●	●			○	○	●			1(2)	Fig. 5 (Grades: ACP_, ACK_) 	
	SFKR 12T3 AZTN		□									3	Fig. 6 	
	UW 12500 R										○	4		
UFO 5000	SFKN 1504 AZFN					○						5(6)	Fig. 2 	
	1504 AZTN	●	●	●								5(6)	Fig. 3 	
													Fig. 4 	

## ■ Recommended Cutting Conditions

( $v_c$  = m/min,  $f_z$  = mm/tooth) (min. – optimum – max.)

Grade	ACPD100												ACPD200			ACPD300		ACK200		ACK300	
	Work Material	Low carbon steel	Alloy steel	Die steel	Low carbon steel	Alloy steel	Die steel	Stainless steel		Cast iron	Ductile cast iron	Cast iron	Ductile cast iron								
								austenitic	martensitic												
UFO (-F) 4000	$V_c$	100-250-400	80-220-280	80-150-250	80-200-370	70-150-250	60-130-220	120-180-240	100-140-200	220-270-450	150-180-250	180-220-270	130-160-220								
	$f_z$	0,1-0,25-0,4	0,1-0,25-0,4	0,1-0,2-0,3	0,1-0,25-0,4	0,1-0,25-0,4	0,1-0,2-0,3	0,1-0,2-0,3	0,1-0,2-0,3	0,1-0,25-0,4	0,1-0,25-0,4	0,1-0,25-0,4	0,1-0,25-0,4								
	$a_p$	1,0-3,0-5,0			1,0-3,0-5,0			1,0-2,0-3,0		1,0-3,0-5,0		1,0-3,0-5,0									
UFO (-F) 5000	$V_c$	100-250-400	80-220-280	80-150-250	80-200-370	70-150-250	60-130-220	120-180-240	100-140-200	220-270-450	150-180-250	180-220-270	130-160-220								
	$f_z$	0,1-0,25-0,4	0,1-0,25-0,4	0,1-0,2-0,3	0,1-0,25-0,4	0,1-0,25-0,4	0,1-0,2-0,3	0,1-0,2-0,3	0,1-0,2-0,3	0,1-0,25-0,4	0,1-0,25-0,4	0,1-0,25-0,4	0,1-0,25-0,4								
	$a_p$	1,0-4,0-7,0			1,0-4,0-7,0			1,0-2,0-5,0		1,0-4,0-7,0		1,0-4,0-7,0									

# Face Mill

## DNX / DNXF Type

General Milling for Cast Iron and Steel

Approach angle : 65°  
 Axial rake angle : +5°  
 Radial rake angle : -6°

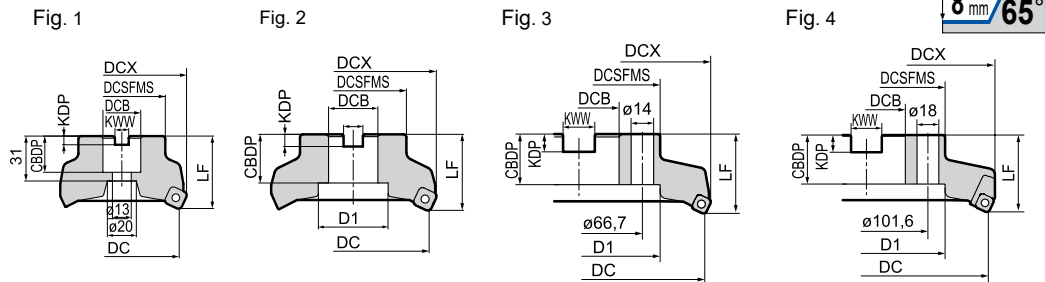

- Body
- Standard DNX - Type

Cat. No.	Stock	Dimensions (mm)										No of Teeth	Max. Depth of Cut	Weight (Kg)	Fig.
		DC	DCX	DCSFMS	LF	DCB	D1	KWW	KDP	CBDP					
DNX 12080 RS	●	80	88	60	50	27	-	12,4	7,0	25	6	8,0	1,2	1	
DNX 12100 RS	●	100	108	80	50	32	46	14,4	8,5	29	7		1,6	2	
12125 RS	●	125	133	80	63	40	56	16,4	9,5	29	8		2,8	2	
12160 RS	●	160	168	100	63	40	88	16,4	9,5	29	10		4,4	3	
DNX 12200 RS	□	200	210	150	63	60	130	25,7	14,0	35	16		8,0	4	
12250 RS	□	250	260	180	63	60	160	25,7	14,0	25	20	12,2	4		

- Fine Pitch DNXF - Type

Cat. No.	Stock	Dimensions (mm)										No of Teeth	Max. Depth of Cut	Weight (Kg)	Fig.
		DC	DCX	DCSFMS	LF	DCB	D1	KWW	KDP	CBDP					
DNXF 12080 RS	●	80	88	60	50	27	-	12,4	7,0	25	8	8,0	1,2	1	
DNXF 12100 RS	●	100	108	80	50	32	46	14,4	8,5	29	10		1,6	2	
12125 RS	●	125	133	80	63	40	56	16,4	9,5	29	11		2,7	2	
12160 RS	●	160	168	100	63	40	88	16,4	9,5	29	12		4,4	3	

### First Recommendation: DNX

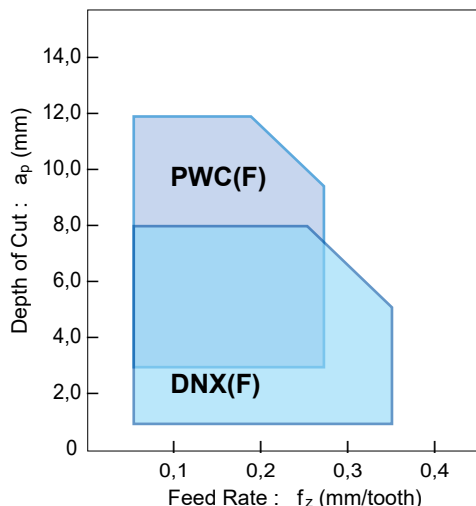

### DNX / DNXF

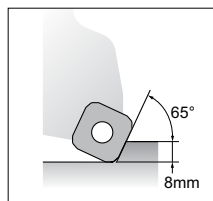

Wiper width = 1,2 mm



Max. depth of cut : 8 mm, Approach angle : 65°		
Cutter Type	Diameter Range	Characteristics
DNX 12000 RS	Ø 80–Ø 250 mm	- General purpose - Medium pitch type
DNXF 12000 RS	Ø 80–Ø 160 mm	- General purpose - Fine pitch type

### Spare Parts

Cutter	Insert Screw	Insert Wrench	Locator	Clamp Screw	Wrench
Ø 80 – Ø 160	BFTX0412 IP	TRDR15 IP	-	-	-
Ø 200, Ø 250			DNXK 12 R	BX 0515	LH 040

### Identification Details

**DNX F 12 080 R S**

Cutter type
Fine pitch
Insert size
Diam.
Cutting direction
Shell type

# Face Mill DNX / DNXF Type

## ■ Features

- Small inserts with 8 cutting edges
- Economic by double-side usage
- Excellent grade for cast iron machining
- Optimised geometry for best results in cast iron
- Special inserts for steel machining

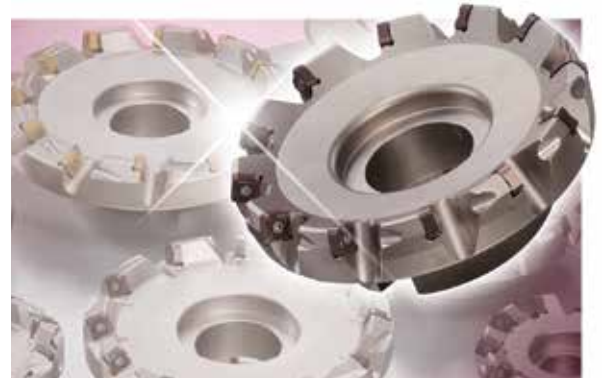

## ■ Insert

Application	Coated Carbide					Fig.
High Speed/Light cut			K	K		
General Purpose	P	P	K	K		
Roughing	P	P			K	
Cat. No.	ACP200	ACP300	ACK100	ACK200	ACK300	
SNMT 1205 ZNEN-L	○					1
1205 ZNEN-G	●		●	●	●	1
1205 ZNEN-H	●		●	●	●	2
1205 ZNEN-SH	●	○	●	●	●	3

Dimensions (mm)

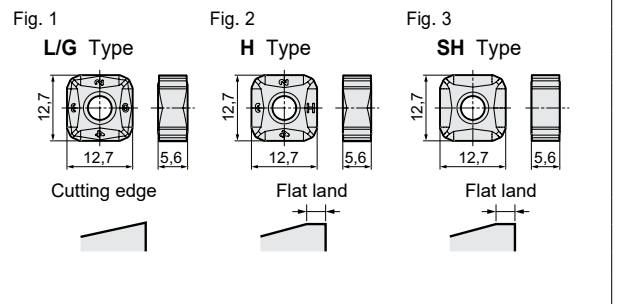

- L Type : For light machining
- G Type : For general purpose
- H Type : For heavy machining
- SH Type : For steel machining

- Negative inserts
- Inserts with 8 cutting edges
- Applicable for steel machining



## ■ Advantage of SH-Type when Steel machining

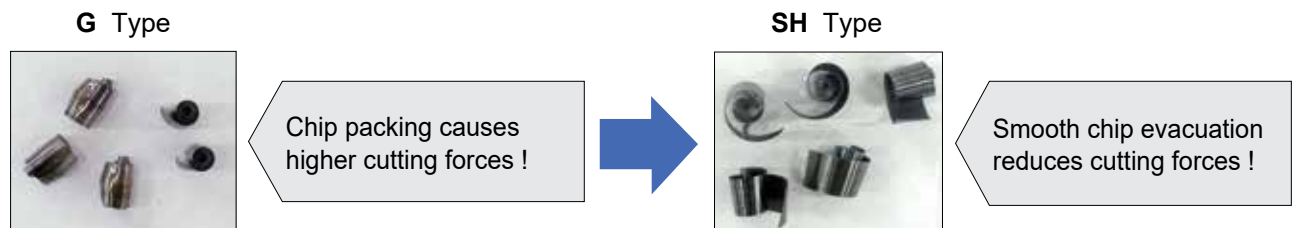

## ■ Recommended Cutting Conditions

( $v_c$  = m/min,  $f_z$  = mm/tooth) (min. – optimum – max.)

ISO	Work Material	Hardness (HB)	Cutting Speed $v_c$ (m/min)	Feed Rate $f_t$ (mm/tooth)	Insert Grade
P	Carbon steel	180–280	150–175–200	0,10–0,15–0,20	ACP200
	Alloy steel	180–280	150–175–200	0,10–0,15–0,20	ACP200
K	Grey cast iron (GG)	250	150–225–300	0,10–0,20–0,30	ACK200/ACK300
	Ductile cast iron (GGG)	250	150–225–250	0,10–0,18–0,25	ACK200/ACK300

# "Wave Radius Mill" WRCX Type



## ■ Features

The "Wave Mill" WRCX type is a new multi purpose milling cutter for face milling, slotting, helical boring, plunging and profiling. Its unique design features 16 corner polygon inserts and a durable cutter body manufactured from high tensile alloyed steel protected by a hard surface treatment. Insert rigidity is maximised via close tolerance seat pockets and centre clamped using a torxscrew. Choose from a variety of insert grades such as our award winning Diamond like Carbon DL 1000 capable of high feed machining aluminium, our uncoated H1 grade suitable for non-ferrous metals or our new ACP/ACK grades for steels and irons.

## ■ Advantages

- Durable cutter body – Special alloyed steel with hard surface.
- High feed cutting – Optimised pitch and high number of cutting edges
- Excellent chip removal – Wide pocket and integral coolant hole
- Maximum rigidity – Rigid clamping of inserts with TORXPLUS screw
- Wide application range – Carbon steels, alloy steels, stainless steels, high temperature alloys, die/mould steels, aluminiums, non-ferrous metals etc

## ■ Insert

Application	Coated Carbide					Uncoated Carbide	Diamond Coated	Dimensions (mm)			Fig.	Applicable Endmill
High Speed / Light cut	P			K		K <sub>N</sub>	N	IC	RE	S		
General Purpose	P <sub>M</sub>	P <sub>M</sub>	K				N					
Roughing	P <sub>M</sub>	P <sub>M</sub>	K									
Cat. No.	ACP100	ACP200	ACP300	ACK200	ACK300	H1	DL1000	IC	RE	S	Fig.	Applicable Endmill
QPMT 120440 PPEN	●	●	●	●	●			12	4,0	4,76	1	WRCX/-F 12000 RS
120440 PPEN-H	●	●	●	●	●	●	●				2	WRCX/-F/-X 16000 RS
QPET 120460 PPF-R-S									6,0			
QPMT 160660 PPEN	●	●	●	●	●			16	6,0	6,5	1	WRCX/-F/-X 16000 RS
160660 PPEN-H	●	●	●	●	●						2	
QPET 160680 PPF-R-S						●	●		8,0			WRCXF 20000 RS
QPMT 200670 PPEN		●	●	●	●			20	7,0	6,5	1	
200670 PPEN-H		●	●	●	●							

Fig. 1

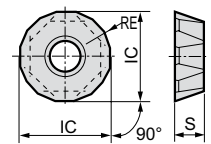
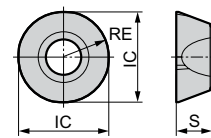

Fig. 2



QPMT... : Standard 16 cornered polygon type  
QPMT...-H: Stronger cutting edge type

QPET...-S: Polished round insert for non-ferrous material

## ● Anti-Vibration Type (Paired Sets for Vibration Free Machining)

Application	Coated Carbide					Uncoated Carbide	Diamond Coated	Dimensions (mm)			Fig.	Applicable Endmill
High Speed / Light cut	P			K		K <sub>N</sub>	N	IC	RE	S		
General Purpose	P <sub>M</sub>	P <sub>M</sub>	K				N					
Roughing	P <sub>M</sub>	P <sub>M</sub>	K									
Cat. No.	ACP100	ACP200	ACP300	ACK200	ACK300	H1	DL1000	IC	RE	S	Fig.	Applicable Endmill
QPMT 160608 PPEN	●	●	●	●	●			16	0,8	6,5	1	WRCX/-F/-X 16000 RS
160608 PPEN-CP	●	●	●	●	●						3	WRCXF 20000 RS
QPMT 200608 PPEN	●	●	●	●	●			20	0,8	6,5	1	
200608 PPEN-CP	●	●	●	●	●						3	

Fig. 1  
08

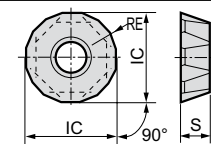
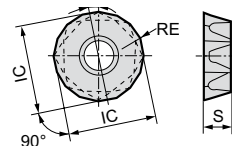

Fig.3  
CP



The combination of different inserts in a staggered formation varies the cut depth and eliminates vibration when feed rate is

$$f_z < 0,15 \quad (IC = 16 \text{ mm})$$

or

$$f_z < 0,2 \quad (IC = 20 \text{ mm}).$$

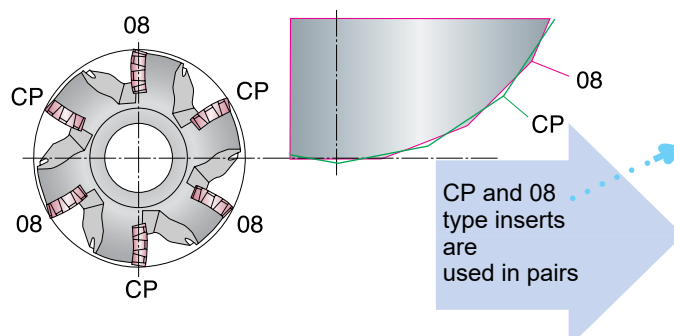

## ● Chip Formation

Anti-vibration Type	Standard Type
Work Material: 50C	
Cutting Data: $f_z = 0,1 \text{ mm/tooth}$ , $a_p = 7 \text{ mm}$	
Insert Size: IC = 20 mm	



# "Wave Radius Mill" WRCX Type



## ■ Body

## ● Standard WRCX Type

Fig. 1

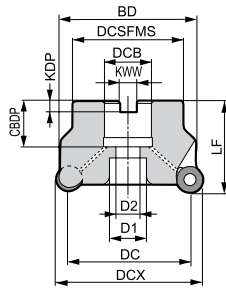

Fig. 2

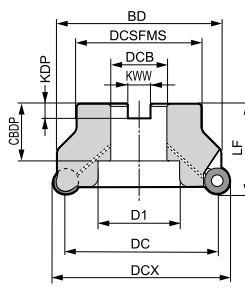
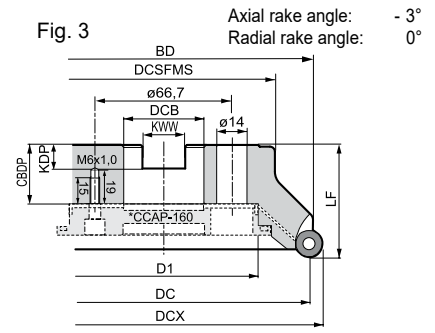

Fig. 3



\* Note Fig.3 for DCX=160 : Coolant cap (CCAP-160) with 4 screws (BX0620) and wrench (TH050) is available separately.

Cat. No.	Stock	Dimensions (mm)											No. of Teeth	Helical Boring øB Standard	Ramping α <sub>max.</sub>	Weight (Kg)	Fig.
		DCX*	DC	BD	DCSFMS	LF*	KWW	KDP	DCB	D2	D1	CDBP					
WRCX 12040 RS	●	40	28	36	36	40	8,4	5,6	16	9	14	18	4	68 ± 11	10°	0,2	1
12050 RS	●	50	38	46	40	40	10,4	6,3	22	11	18	20	4	88 ± 11	7°	0,3	1
12052 RS	●	52	40	48	40	40	10,4	6,3	22	11	18	20	5	92 ± 11	6°30'	0,3	1
12063 RS	●	63	51	59	40	40	10,4	6,3	22	11	18	20	5	114 ± 11	5°	0,4	1
12080 RS	●	80	68	76	55	50	12,4	7,0	27	13,5	20	25	6	148 ± 11	3°30'	0,9	1
WRCX 16063 RS	●	63	47	50	50	40	10,4	6,3	22	11	18	20	3	110 ± 15	8°	0,4	1
16080 RS	●	80	64	70	55	50	12,4	7,0	27	13,5	20	25	4	144 ± 15	5°30'	0,8	1
WRCX 16100 RS	●	100	84	90	70	50	14,4	8,5	32	-	46	32	5	184 ± 15	4°	1,3	2
16125 RS	□	125	109	115	80	63	16,4	9,5	40	-	52	38	5	234 ± 15	3°	2,4	2

## ● Fine Pitch WRCXF Type

Cat. No.	Stock	Dimensions (mm)											No. of Teeth	Helical Boring øB Standard	Ramping α <sub>max.</sub>	Weight (Kg)	Fig.
		DCX*	DC	BD	DCSFMS	LF*	KWW	KDP	DCB	D2	D1	CDBP					
WRCXF 12050 RS	○	50	38	46	40	40	10,4	6,3	22	11	18	20	5	88 ± 11	7°	0,3	1
12063 RS	○	63	51	59	40	40	10,4	6,3	22	11	18	20	6	114 ± 11	5°	0,4	1
WRCXF 16052 RS	●	52	36	45	45	40	10,4	6,3	22	11	17,7	20	4	88 ± 15	10°	0,3	1
16063 RS	●	63	47	50	50	40	10,4	6,3	22	11	18	20	4	110 ± 15	8°	0,4	1
16080 RS	●	80	64	70	55	50	12,4	7,0	27	13,5	20	25	5	144 ± 15	5°30'	0,8	1
WRCXF 16100 RS	●	100	84	90	70	50	14,4	8,5	32	-	46	32	6	184 ± 15	4°	1,3	2
16125 RS	●	125	109	115	80	63	16,4	9,5	40	29	52	29	6	234 ± 15	3°	2,4	1
16160 RS	●	160	144	150	100	63	16,4	9,5	40	-	93	29	8	304 ± 15	2°	4,0	3*
WRCXF 20080 RS	●	80	60	68	55	50	12,4	7,0	27	13,5	20	25	5	140 ± 18	7°	0,7	1
WRCXF 20100 RS	●	100	80	88	70	50	14,4	8,5	32	-	46	32	6	180 ± 18	5°	1,1	2
20125 RS	●	125	105	113	80	63	16,4	9,5	40	29	52	29	6	230 ± 18	3°30'	2,3	1
20160 RS	●	160	140	148	100	63	16,4	9,5	40	-	93	29	8	300 ± 18	2°30'	3,9	3*

## ● Extra Fine Pitch WRCXX Type

Cat. No.	Stock	Dimensions (mm)											No. of Teeth	Helical Boring øB Standard	Ramping α <sub>max.</sub>	Weight (Kg)	Fig.
		DCX*	DC	BD	DCSFMS	LF*	KWW	KDP	DCB	D2	D1	CDBP					
WRCXX 16080 RS	●	80	64	70	55	50	12,4	7,0	27	13,5	20	25	6	144 ± 15	5°30'	0,8	1
16100 RS	●	100	84	90	70	50	14,4	8,5	32	-	46	32	7	184 ± 15	4°	1,3	2

\* Note : When using CP type anti-vibration inserts / IC = 16, please change above dimensions: DCX\* +0,3 & LF\* +0,15 mm  
In case of anti-vibration inserts / IC = 20, please change above dimensions: DCX\* +0,4 & LF\* +0,2 mm

## ■ Maximum Rotation (min<sup>-1</sup>) for Non-ferrous cutting when using QPET Insert

Cutter DC (mm)	Insert Cat. No.		
	QPET10...S	QPET12...S	QPET16...S
25	28.000		
32	25.000		
40		22.000	15.000
50		20.000	14.000
63		18.000	13.000
80		16.000	12.000
100			10.000
125			9.000
160			8.000

## ■ Spare Parts

Cutter	Screw	Screw
WRCX 12000	BFTX 0409 IP 3,0	TRDR 15 IP
WRCX/F-X	16052-16100 BFTX 0511 IP 5,0	TRDR 20 IP
	16125-16160 BFTX 0513 IP 5,0	
WRCX/F	20000 BFTX 0615 IP 5,0	TRDR 25 IP

## Ramping (Slant Milling)

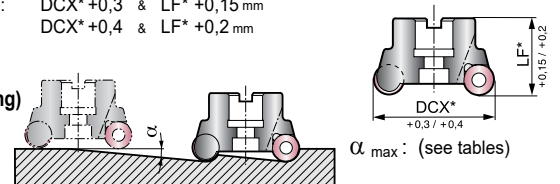

## Helical Boring

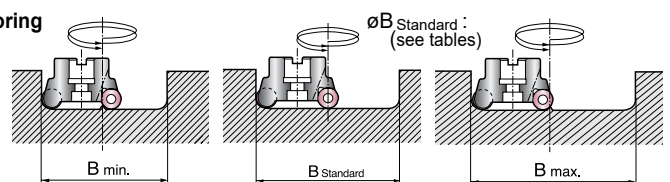

## ■ Recommended Cutting Conditions

Material Grade	DCX (mm)	Carbon steel (ex. C40 ~ C50)	Alloy steel (Below HRC40)	Stainless steel (ex. X10CrNiS18-9)	Cast iron (ex. GG20)	Non-ferrous material
		40 ~ 80	$v_c$ : 100-160-200 $f_z$ : 0,2-0,4-0,6	100-140-180	80-120-160	80-120-160
100 ~ 160	$v_c$ : 150-200-250 $f_z$ : 0,3-0,4-0,6	100-160-200	160-180-200	100-150-200	200-500-1000	

[v<sub>c</sub> = m/min, f<sub>z</sub> = mm/tooth] [min. - optimum - max.]



# "Wave Radius Mill"

## RSX Series



### ■ Features

The Wave Radius Mill RSX Series enables stable machining even when using equipment with low clamp rigidity thanks to its body design achieving excellent cutting performance and rigidity.

In addition to the ACM Series for stainless steel and exotic alloys two grades have been added: ACP200 grade for steel machining and ACK300 grade for cast iron machining. Handle an even wider range of milling needs with the RSX(F)08000 and RSX(F)20000 types.



### ■ Characteristics

Smooth cutting action and low vibration machining provided based on the high rake angle design and high rigidity body.

High reliability achieved with ACM100/ACM200/ACM300 adopted for exotic alloy machining.

ACP200 for steel and ACK300 for cast iron enable stable machining in a wide range of applications.

### ■ Series

Image	Series	Insert Size	Cat. No.	External Diameter (mm)											
				Ø 20	Ø 25	Ø 32	Ø 40	Ø 50	Ø 52	Ø 63	Ø 66	Ø 80	Ø 100	Ø 125	Ø 160
 → H76	Standard	08	RSX 08000 ES	●	●										
		10	10000 ES		●	●									
		12	12000 ES			●									
	Fine Pitch	08	RSXF 08000 ES	●	●										
		10	10000 ES		●	●									
		12	12000 ES			●									
	Standard	10	RSX 10000 RS				●	●	●						
		12	12000 RS				●	●	●	●	●	●	●		
		16	16000 RS							●	●	●	●	●	
		20	20000 RS									●	●	●	
	Fine Pitch	10	RSXF 10000 RS				●	●	●						
		12	12000 RS				●	●	●	●	●	●	●		
 → H77	Standard	08	RSX 08000 M	●	●	●									
		10	10000 M		●	●									
		12	12000 M			●	●								
	Fine Pitch	08	RSXF 08000 M	●	●	●									
		10	10000 M		●	●									
		12	12000 M			●	●								

### ■ Cutting Performance

#### ● Tool Life Comparison (Fracture Resistance)

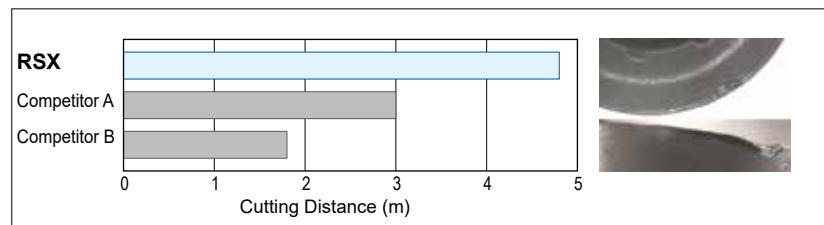

#### ● Cutting Vibration Comparison

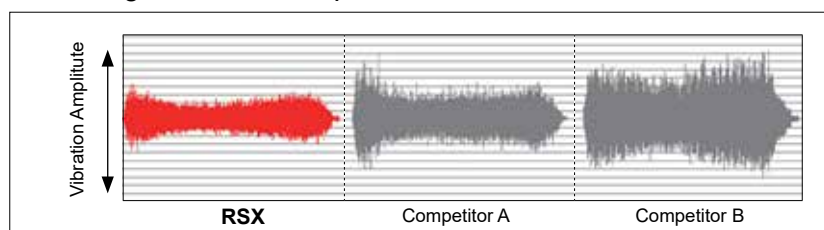

#### ● Cutting Resistance Comparison

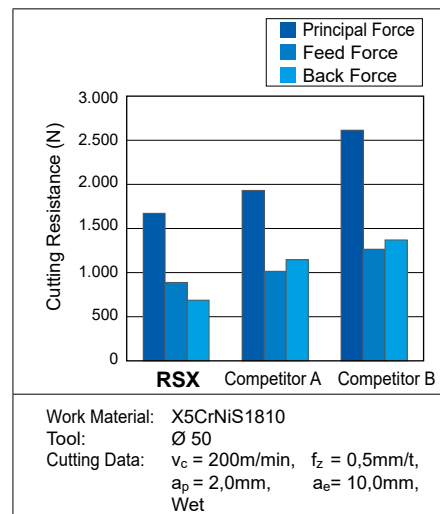

# "Wave Radius Mill" RSX Series

## Low Cutting Resistance, Less Vibration

Low cutting resistance and low vibration machining have been achieved with super high rake angle design + high rigidity body.

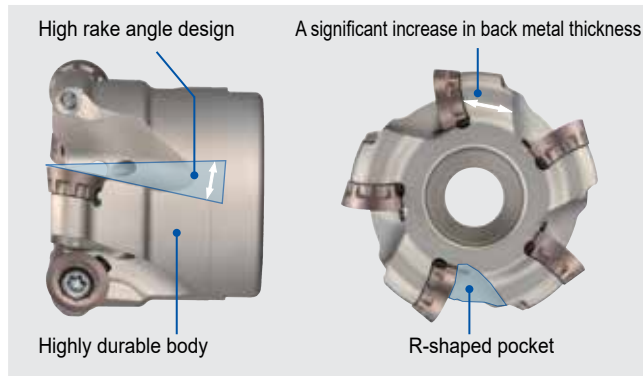

## High Operability

Ease of corner control has been achieved with the adoption of a unique positioning mechanism that is highly precise and highly operable.

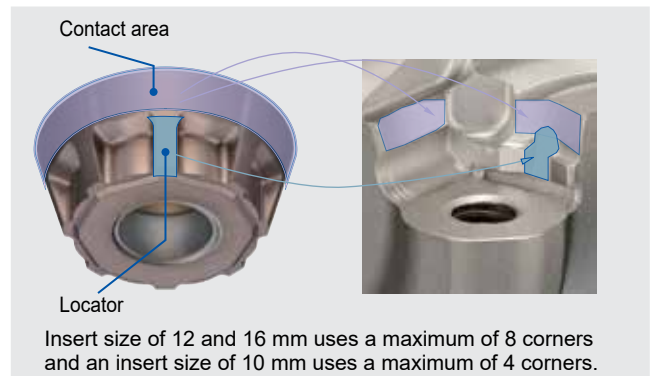

## Stable and Long Tool Life

Work Material	Wear Resistance ← → Fracture Resistance	
	<b>P</b>	ACP200
<b>M</b>	ACM100	
	ACM200	
	ACM300	
<b>K</b>	ACK300	
<b>S</b>	ACM100	
	ACM200	
	ACM300	

Coating Type: ▽ CVD ▲ PVD

A long life ensured with the adoption of the ACM series and significant improvements have been made in processing exotic alloy and stainless steel machining.

### ▲ ACM100/ACM300

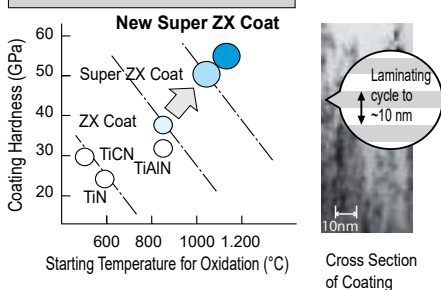

### New Super ZX Coat

The product series with a coating film hardness approximately 40 % higher and an oxidation onset temperature 200 °C higher than conventional products. Enables machining at least 1,5 times faster and more efficiently than conventional products. A product life at least twice as long as that of conventional products achieved under the same machining conditions.

### ▽ ACM200

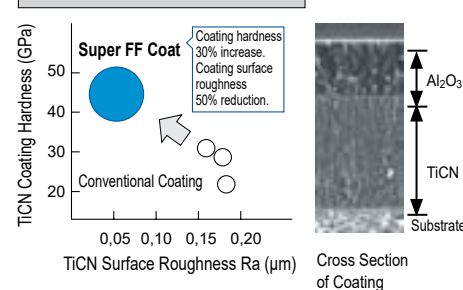

### Super FF Coat

Smooth coating surface provides excellent adhesion and chipping resistance. Improved coating adhesion strength. Harder than conventional coatings with high improvements in wear resistance. High speed, high efficiency machining of more than 1,5 times than of conventional grades possible. Achieving more than double the tool life of conventional grades under the same cutting conditions.

# "Wave Radius Mill"

## RSX(F)<sub>10000/12000/16000/20000RS</sub>

Milling of steel, stainless steel, cast iron and exotic alloys

### ■ Body – Dimensions



Fig. 1

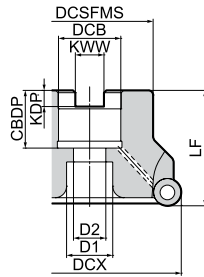

Fig. 2

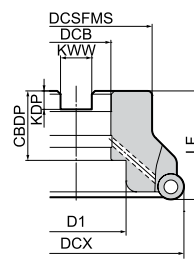
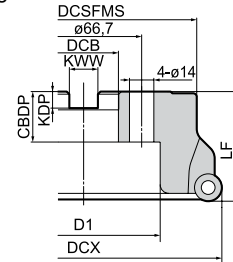
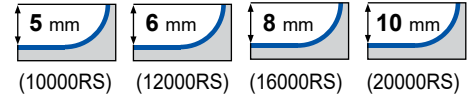

Fig. 3



Rake Angle	Radial	-5°
	Axial	10°



### ■ Body

#### ● RSX...RS, Standard

Cat. No.	Stock	Dimensions (mm)										No. of Teeth	Weight (kg)	Fig.
		DCX	DCSFMS	LF	DCB	KWW	KDP	CBDP	D1	D2				
RSX 10040 RS	●	40	34	40	16	8,4	5,6	18	14	9	4	0,2	1	
RSX 10050 RS	●	50	40	40	22	10,4	6,3	20	18	11	5	0,3	1	
RSX 10052 RS	●	52	40	40	22	10,4	6,3	20	18	11	5	0,4	1	
RSX 12040 RS	●	40	32	40	16	8,4	5,6	18	13,5	9	3	0,2	1	
RSX 12050 RS	●	50	40	40	22	10,4	6,3	20	18	11	4	0,3	1	
RSX 12052 RS	○	52	40	40	22	10,4	6,3	20	18	11	4	0,3	1	
RSX 12063 RS	●	63	40	40	22	10,4	6,3	20	18	11	5	0,4	1	
RSX 12066 RS	●	66	55	50	27	12,4	7,0	25	20	14	6	0,7	1	
RSX 12080 RS	●	80	55	50	27	12,4	7,0	25	20	14	6	1,0	1	
RSX 12100 RS	●	100	70	50	32	14,4	8,5	32	46	-	6	1,4	2	
RSX 16063 RS	●	63	50	40	22	10,4	6,3	20	18	11	4	0,5	1	
RSX 16080 RS	●	80	55	50	27	12,4	7,0	25	20	14	5	0,9	1	
RSX 16100 RS	●	100	70	50	32	14,4	8,5	32	46	-	6	1,3	2	
RSX 16125 RS	●	125	80	63	40	16,4	9,5	29	52	29	6	2,6	1	
RSX 20080 RS	○	80	55	50	27	12,4	7,0	22	20	14	4	0,9	1	
RSX 20100 RS	●	100	70	63	32	14,4	8,0	32	46	-	5	1,8	2	
RSX 20125 RS	●	125	80	63	40	16,4	9,0	29	52	29	6	2,6	1	
RSX 20160 RS	●	160	130	63	40	16,4	9,0	29	90	-	7	4,7	3	

#### ● RSXF...RS, Fine Pitch

Cat. No.	Stock	Dimensions (mm)										No. of Teeth	Weight (kg)	Fig.
		DCX	DCSFMS	LF	DCB	KWW	KDP	CBDP	D1	D2				
RSXF 10040 RS	●	40	34	40	16	8,4	5,6	18	14	9	5	0,2	1	
RSXF 10050 RS	●	50	40	40	22	10,4	6,3	20	18	11	6	0,3	1	
RSXF 10052 RS	●	52	40	40	22	10,4	6,3	20	18	11	6	0,3	1	
RSXF 12040 RS	●	40	32	40	16	8,4	5,6	18	13,5	9	4	0,2	1	
RSXF 12050 RS	●	50	40	40	22	10,4	6,3	20	18	11	5	0,3	1	
RSXF 12052 RS	●	52	40	40	22	10,4	6,3	20	18	11	5	0,3	1	
RSXF 12063 RS	●	63	40	40	22	10,4	6,3	20	18	11	6	0,4	1	
RSXF 12066 RS	●	66	55	50	27	12,4	7,0	25	20	14	7	0,7	1	
RSXF 12080 RS	●	80	55	50	27	12,4	7,0	25	20	14	7	0,9	1	
RSXF 12100 RS	●	100	70	50	32	14,4	8,5	32	46	-	10	1,3	2	
RSXF 16063 RS	●	63	50	40	22	10,4	6,3	20	18	11	5	0,4	1	
RSXF 16080 RS	●	80	55	50	27	12,4	7,0	25	20	14	6	0,8	1	
RSXF 16100 RS	●	100	70	50	32	14,4	8,5	32	46	-	7	1,3	2	
RSXF 16125 RS	●	125	80	63	40	16,4	9,5	29	52	29	8	2,5	1	
RSXF 16160 RS	□	160	130	63	40	16,4	9,5	29	88	-	10	4,8	3	
RSXF 20080 RS	●	80	55	50	27	12,4	7,0	22	20	14	5	0,9	1	
RSXF 20100 RS	●	100	70	50	32	14,4	8,0	32	46	-	6	1,8	2	
RSXF 20125 RS	○	125	80	63	40	16,4	9,0	29	52	29	7	2,6	1	
RSXF 20160 RS	○	160	130	63	40	16,4	9,0	29	90	-	9	4,6	3	

### ■ Identification Details

<b>RSX</b>	<b>F</b>	<b>12</b>	<b>040</b>	<b>R</b>	<b>S</b>
Cutter Series	Fine Pitch Type	Insert Size	Cutter Diameter	Cutting Direction	Metric

● = Euro stock  
○ = Japan stock

□ = Delivery on request

Ⓜ Recommended Tightening Torque (N·m)

# "Wave Radius Mill" RSX(F)10000/12000/16000/20000RS

## Various Machining Use

Various types of processing, such as mould engraving, slant milling and helical processing.

Helical Milling	Ramping	Recommended Values for Helical and Ramping																																																																																																																														
<p>Helical Milling <math>\phi D</math></p> <p><math>\leq</math> Work Diameter <math>\phi D</math> Center uncut portion cannot be removed by traverse cutting with the same cutter.</p> <p><math>\geq</math> Work Diameter <math>\phi D</math> Center uncut portion can be removed by traverse cutting with the same cutter.</p>	<p>Use at <math>\alpha^\circ</math> or lower</p>	<table border="1"> <thead> <tr> <th rowspan="2">Insert Cat. No.</th> <th colspan="4">Helical</th> <th>Taper</th> </tr> <tr> <th>Cutter <math>\phi DC</math></th> <th colspan="3">Work Diameter</th> <th>Ramping Angle <math>\alpha^\circ</math> (max)</th> </tr> <tr> <td></td> <td></td> <th>Min.</th> <th>Optimal <math>\phi</math></th> <th>Max.</th> <td></td> </tr> </thead> <tbody> <tr> <td rowspan="4">RDET10...</td> <td>25</td> <td>33,0</td> <td>40</td> <td>49</td> <td>10°30'</td> </tr> <tr> <td>32</td> <td>46,0</td> <td>54</td> <td>63</td> <td>6°45'</td> </tr> <tr> <td>40</td> <td>62,0</td> <td>70</td> <td>79</td> <td>4°30'</td> </tr> <tr> <td>50</td> <td>82,0</td> <td>90</td> <td>99</td> <td>3°15'</td> </tr> <tr> <td rowspan="5">RDET12...</td> <td>52</td> <td>86,0</td> <td>94</td> <td>103</td> <td>3°10'</td> </tr> <tr> <td>32</td> <td>41,5</td> <td>52</td> <td>63</td> <td>12°30'</td> </tr> <tr> <td>40</td> <td>57,5</td> <td>68</td> <td>79</td> <td>8°00'</td> </tr> <tr> <td>50</td> <td>77,5</td> <td>88</td> <td>99</td> <td>5°30'</td> </tr> <tr> <td>52</td> <td>81,5</td> <td>92</td> <td>103</td> <td>5°15'</td> </tr> <tr> <td rowspan="5">RDET16...</td> <td>63</td> <td>103,5</td> <td>114</td> <td>125</td> <td>4°00'</td> </tr> <tr> <td>66</td> <td>109,5</td> <td>120</td> <td>131</td> <td>3°45'</td> </tr> <tr> <td>80</td> <td>137,5</td> <td>148</td> <td>159</td> <td>2°50'</td> </tr> <tr> <td>100</td> <td>177,5</td> <td>188</td> <td>199</td> <td>2°10'</td> </tr> <tr> <td>63</td> <td>96,0</td> <td>110</td> <td>125</td> <td>6°00'</td> </tr> <tr> <td rowspan="4">RDET20...</td> <td>80</td> <td>130,0</td> <td>144</td> <td>159</td> <td>4°10'</td> </tr> <tr> <td>100</td> <td>170,0</td> <td>184</td> <td>199</td> <td>3°00'</td> </tr> <tr> <td>125</td> <td>220,0</td> <td>234</td> <td>249</td> <td>2°20'</td> </tr> <tr> <td>80</td> <td>122,0</td> <td>140</td> <td>159</td> <td>4°15'</td> </tr> <tr> <td>100</td> <td>162,0</td> <td>180</td> <td>199</td> <td>3°00'</td> </tr> <tr> <td>125</td> <td>212,0</td> <td>230</td> <td>249</td> <td>2°00'</td> </tr> <tr> <td>160</td> <td>282,0</td> <td>300</td> <td>319</td> <td>1°15'</td> </tr> </tbody> </table>	Insert Cat. No.	Helical				Taper	Cutter $\phi DC$	Work Diameter			Ramping Angle $\alpha^\circ$ (max)			Min.	Optimal $\phi$	Max.		RDET10...	25	33,0	40	49	10°30'	32	46,0	54	63	6°45'	40	62,0	70	79	4°30'	50	82,0	90	99	3°15'	RDET12...	52	86,0	94	103	3°10'	32	41,5	52	63	12°30'	40	57,5	68	79	8°00'	50	77,5	88	99	5°30'	52	81,5	92	103	5°15'	RDET16...	63	103,5	114	125	4°00'	66	109,5	120	131	3°45'	80	137,5	148	159	2°50'	100	177,5	188	199	2°10'	63	96,0	110	125	6°00'	RDET20...	80	130,0	144	159	4°10'	100	170,0	184	199	3°00'	125	220,0	234	249	2°20'	80	122,0	140	159	4°15'	100	162,0	180	199	3°00'	125	212,0	230	249	2°00'	160	282,0	300	319	1°15'
Insert Cat. No.	Helical				Taper																																																																																																																											
	Cutter $\phi DC$	Work Diameter			Ramping Angle $\alpha^\circ$ (max)																																																																																																																											
		Min.	Optimal $\phi$	Max.																																																																																																																												
RDET10...	25	33,0	40	49	10°30'																																																																																																																											
	32	46,0	54	63	6°45'																																																																																																																											
	40	62,0	70	79	4°30'																																																																																																																											
	50	82,0	90	99	3°15'																																																																																																																											
RDET12...	52	86,0	94	103	3°10'																																																																																																																											
	32	41,5	52	63	12°30'																																																																																																																											
	40	57,5	68	79	8°00'																																																																																																																											
	50	77,5	88	99	5°30'																																																																																																																											
	52	81,5	92	103	5°15'																																																																																																																											
RDET16...	63	103,5	114	125	4°00'																																																																																																																											
	66	109,5	120	131	3°45'																																																																																																																											
	80	137,5	148	159	2°50'																																																																																																																											
	100	177,5	188	199	2°10'																																																																																																																											
	63	96,0	110	125	6°00'																																																																																																																											
RDET20...	80	130,0	144	159	4°10'																																																																																																																											
	100	170,0	184	199	3°00'																																																																																																																											
	125	220,0	234	249	2°20'																																																																																																																											
	80	122,0	140	159	4°15'																																																																																																																											
100	162,0	180	199	3°00'																																																																																																																												
125	212,0	230	249	2°00'																																																																																																																												
160	282,0	300	319	1°15'																																																																																																																												

## Inserts

Dimensions (mm)

Application	Grade					Dimens.		Applicable Cutters
High Speed/Light Cut			M S	M S		$\phi d$ (IC)	S	
General Purpose	P M		M S	M S	M S			
Roughing	P M	K			M S			
Cat. No.	ACP200	ACK300	ACM100	ACM200	ACM300	$\phi d$ (IC)	S	
RDET 10T3M0EN G	●	●	●	●	●	10	3,97	RSX(F) 10000RS
10T3M0EN H	●	●	●	●	●	10	3,97	
RDET 1204M0EN G	●	●	●	●	●	12	4,76	RSX(F) 12000RS
1204M0EN H	●	●	●	●	●	12	4,76	
RDET 1606M0EN G	●	●	●	●	●	16	6,5	RSX(F) 16000RS
1606M0EN H	●	●	○	●	●	16	6,5	
RDET 2006M0EN G	●	●	○	●	●	20	6,5	RSX(F) 20000RS
2006M0EN H	○	●	○	○	●	20	6,5	

IC $\pm$ 0,025

S $\pm$ 0,025

Cutting Edge Cross Section

G - Type      H - Type

M0: IC is metric

## Spare Parts

Applicable Cutters	Wrench	Screw	
RSX(F) 10000RS	TRDR15IP	BFTX03584IP	3,0
RSX(F) 12000RS		BFTX0409IP	3,0
RSX(F) 16000RS	TRDR20IP	BFTX0511IP	5,0
RSX(F) 20000RS	TRDR25IP	BFTX0615IP	5,0

## Recommended Cutting Conditions

Min.-Optimum-Max.

ISO	Work Material		Hardness (HB)	Cutting Speed $v_c$ (m/min)	Feed Rate $f_z$ (mm/t)	Grade	
P	Carbon Steel		180-280	100-160-200	0,20-0,40-0,60	ACP200	
	Alloy Steel		180-280	100-140-180	0,20-0,30-0,40	ACP200	
M	Stainless Steel	Cr Based	Ferritic	200	150-180-200	0,15-0,25-0,35	ACM300
			Martensitic	200-330	80-120-180	0,15-0,25-0,35	ACM300
	Cr-Ni Based	Austenitic	200	150-180-200	0,15-0,25-0,35	ACM300	
		Austenitic, ferritic	230-270	80-120-180	0,15-0,25-0,35	ACM200	
		Precipitation hardening	330	60-100-160	0,15-0,25-0,35	ACM200	
K	Cast Iron		250	80-120-160	0,10-0,30-0,40	ACK300	
S	Heat resistant alloy	Ni based material		250-350	20-30-40	ACM100 ACM200	
	Titanium	Pure Titanium		(Rm 400)	60-80-100		
		$\alpha + \beta$ alloy system		(Rm 1050)	40-50-60		

# "Sumi Dual Mill"

## DFC Type

Expansion

### General Features

The Sumi Dual Mill DFC type employs cost effective double-sided inserts for high toughness and enhanced accuracy. The double-side inserts are flexible and reduces costs.

### Large Line-up

- Diameter from Ø 25 mm to Ø 200 mm
- Available as standard, fine and extra-fine pitch
- Bore diameter: metric
- Insert geometry: L, G, GS, H



### Cutter Body

Type		Cat. No.	Diameter (mm)	No. of Teeth	Image
Shank	Standard Pitch	DFC 09000 E	Ø 25–Ø 80	2–5	
	Medium Pitch → H17	DFCM 09000 E	Ø 32–Ø 80	3–7	
Shell	Standard Pitch	DCF 09000 RS	Ø 50–Ø 200	4–10	
	Medium Pitch	DFCM 09000 RS	Ø 50–Ø 200	5–16	
	Fine Pitch	DFCF 09000 RS	Ø 50–Ø 200	6–20	

### 90 Degree Accuracy

Work material: Carbon steel

Cutting conditions:  
 $v_c = 200 \text{ m/min}$ ,  $f_z = 0,1 \text{ mm/t}$   
 $a_e = 5,0 \text{ mm}$ ,  $a_p = 5,0 \text{ mm} \times 3 \text{ passes}$

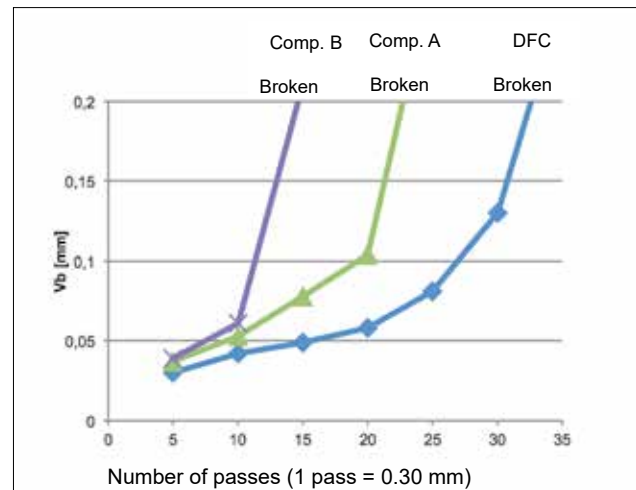
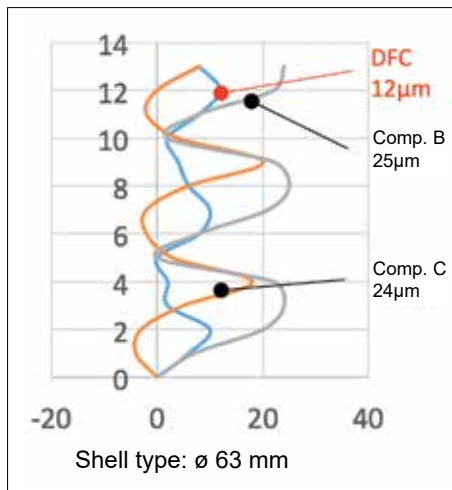

### Applications and Recommended Chipbreakers

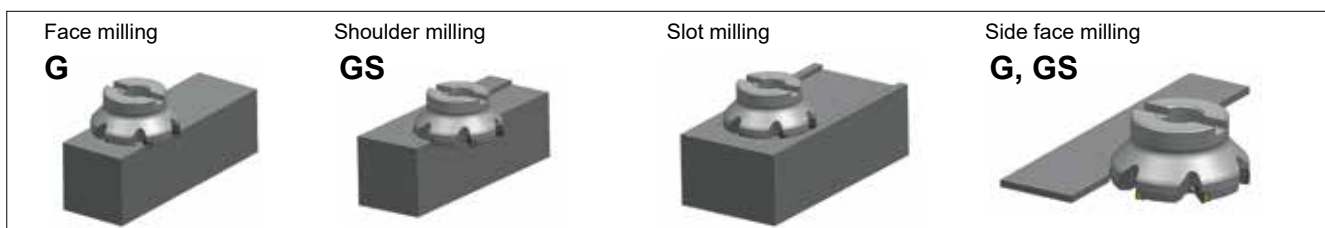

● = Euro stock



# "Sumi Dual Mill" DFC Type

## ■ New Insert Design Provides Excellent Machining Accuracy

- The new insert design separates the location area and cutting edge producing an optimized solution.
- Machining accuracy is comparable to single sided inserts provided the DOC is less than 3 mm.
- The SEC-Sumi Dual Mill design, equips the user with a highly stable cutter for high feed machining applications.

## ● Chipbreaker Selection Map

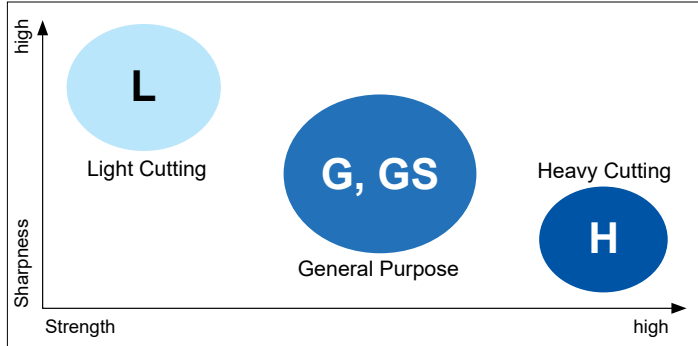

## ● Inserts

Cat. No.	RE0,4	RE0,8	RE1,2	RE1,6
XNMU0606__PNER-L	●	●		
XNMU0606__PNER-G	●	●	●	●
XNMU0606__PNER-GS	●	●	●	●
XNMU0606__PNER-H		●	●	●

Work Material	P M K S			
	L type	G type	GS type	H type
Chipbreaker				
Applications	Light cutting	General purpose to interrupted milling	Shoulder milling	Heavy cutting
Cutting edge geometry				
Features	Low rigidity milling, reduction of burrs	Face milling	Shoulder milling	Roughing, heavy interrupted and hardness steel milling

## ■ Stable and High Cutting Performance Combined with High Toughness

- The excellent cutter performance offers efficient machining, enables high feed rate capability.
- The new insert construction provides extremely accurate edge to edge indexing whilst the location area offers high security and stability.

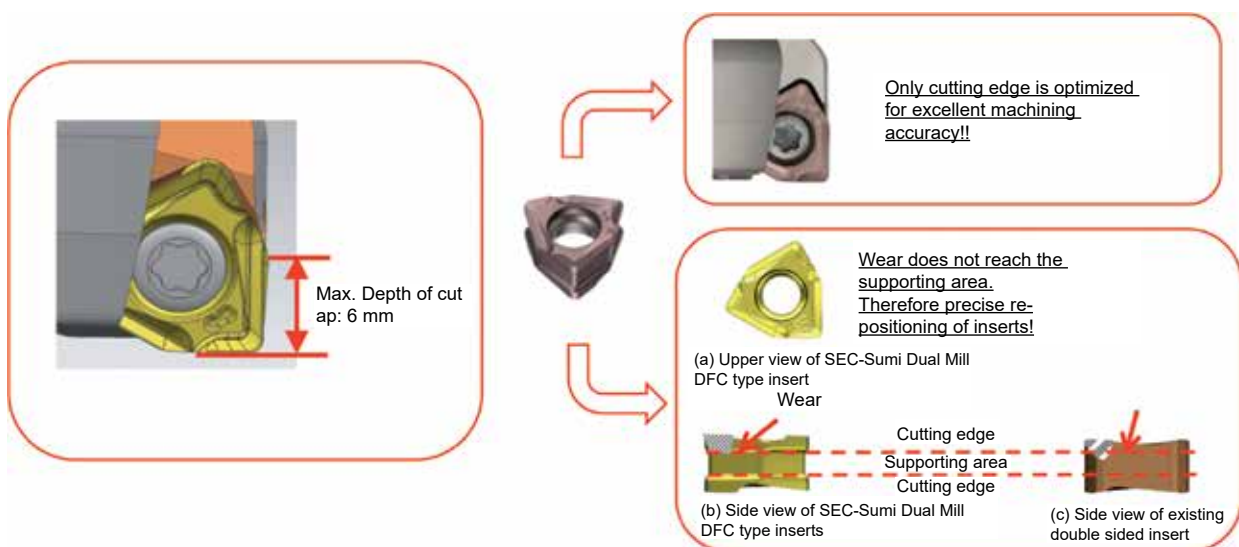



# "Sumi Dual Mill" DFC(M/F) 09000RS

Body – Shell type

Rake Angle	Radial	-9°
	Axial	-5°

Max.  $a_p$ : 6 mm



Fig.1

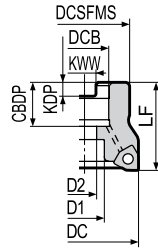

Fig.2

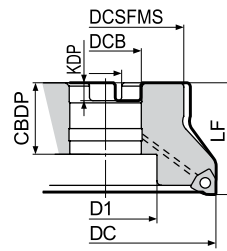
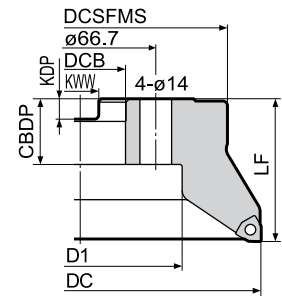

Fig.3



## Body – Dimensions

### ● Sumi Dual Mill DFC type, Standard Pitch

Cat. No.	Stock	Dimensions (mm)										No. of Teeth	Weight (kg)	Fig.
		DC	DCSFMS	LF	DCB	KWW	KDP	CBDP	D1	D2				
DFC 09050RS	●	50	41	40	22	10,4	6,3	20	18	11	4	0,3	1	
09063RS	●	63	50	40	22	10,4	6,3	20	18	11	4	0,5	1	
09080RS	●	80	55	50	27	12,4	7	22	20	14	5	1,0	1	
DFC 09100RS	●	100	70	50	32	14,4	8	26	46	-	6	1,4	2	
09125RS	●	125	80	63	40	16,4	9	29	52	29	7	2,8	1	
09160RS	●	160	130	63	40	16,4	9	29	90	-	8	4,6	3	
DFC 09200RS	□	200	150	63	60	25,7	14	35	135	-	10	5,7		

### ● Sumi Dual Mill DFC type, Medium Pitch

Cat. No.	Stock	Dimensions (mm)										No. of Teeth	Weight (kg)	Fig.
		DC	DCSFMS	LF	DCB	KWW	KDP	CBDP	D1	D2				
DFCM 09050RS	●	50	41	40	22	10,4	6,3	20	18	11	5	0,3	1	
09063RS	●	63	50	40	22	10,4	6,3	20	18	11	6	0,5	1	
09080RS	●	80	55	50	27	12,4	7	22	20	14	7	0,9	1	
DFCM 09100RS	●	100	70	50	32	14,4	8	26	46	-	8	1,4	2	
09125RS	●	125	80	63	40	16,4	9	29	52	29	11	2,7	1	
09160RS	●	160	130	63	40	16,4	9	29	90	-	12	4,5	3	
DFCM 09200RS	□	200	150	63	60	25,7	14	35	135	-	16	5,6		

### ● Sumi Dual Mill DFC type, Fine Pitch

Cat. No.	Stock	Dimensions (mm)										No. of Teeth	Weight (kg)	Fig.
		DC	DCSFMS	LF	DCB	KWW	KDP	CBDP	D1	D2				
DFCF 09050RS	●	50	41	40	22	10,4	6,3	20	18	11	6	0,3	1	
09063RS	●	63	50	40	22	10,4	6,3	20	18	11	7	0,5	1	
09080RS	●	80	55	50	27	12,4	7	22	20	14	9	0,9	1	
DFCF 09100RS	●	100	70	50	32	14,4	8	26	46	-	11	1,3	2	
09125RS	●	125	80	63	40	16,4	9	29	52	29	14	2,6	1	
09160RS	●	160	130	63	40	16,4	9	29	90	-	16	4,6	3	
DFCF 09200RS	□	200	150	63	60	25,7	14	35	135	-	20	5,5		

## Identification Details

**DFC**

Cutter Series

**M**

M: Medium  
F: Fine

**09**

Insert Size

**050**

Cutter Diameter



**R**

Direction

**S**

Metric

## Spare Parts

Screw	Wrench
	
BFTX03512IP	5,0 TRDR151P

## ■ Inserts

Application		Coated Carbide								RE	Dimensions (mm)
High Speed / Light Cutting	General Purpose Cutting	ACU2500	XCU2500	ACP100	ACP200	ACP300	XCK2000	ACK200	ACK300		
High Speed / Light Cutting	General Purpose Cutting	●	●	●	●	●	●	●	●	●	●
General Purpose Cutting	Rough Cutting	●	○	○	○	○	○	○	○	○	○
Rough Cutting		○	○	○	○	○	○	○	○	○	○
Cat. No.											
XNMU 060604 PNER-L		●	○	○	○	○	○	○	○	○	○
060608 PNER-L		●	○	○	○	○	○	○	○	○	○
XNMU 060604 PNER-G		●	○	○	○	○	○	○	○	○	○
060608 PNER-G		●	○	○	○	○	○	○	○	○	○
060612 PNER-G		●	○	○	○	○	○	○	○	○	○
060616 PNER-G		●	○	○	○	○	○	○	○	○	○
XNMU 060604 PNER-GS		○	○	○	○	○	○	○	○	○	○
060608 PNER-GS		○	○	○	○	○	○	○	○	○	○
060612 PNER-GS		○	○	○	○	○	○	○	○	○	○
060616 PNER-GS		○	○	○	○	○	○	○	○	○	○
XNMU 060608 PNER-H		●	○	○	○	○	○	○	○	○	○
060612 PNER-H		●	○	○	○	○	○	○	○	○	○
060616 PNER-H		●	○	○	○	○	○	○	○	○	○

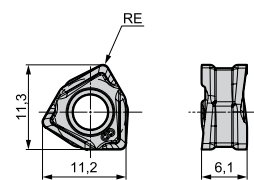

## ■ Recommended Cutting Conditions

ISO	Work-material	Hardness (HB)	Cutting Speed (m/min)	Feed Rate	Depth of Cut (mm)	Grade
P	General Steel	180–280	150–200–250	0,10–0,20–0,30	< 6	ACU2500
	Soft Steel	≤180	180–250–350	0,15–0,25–0,35	< 6	ACP200
	Die Steel	200–220	100–150–200	0,10–0,18–0,25	< 4	ACP300
M	Stainless Steel	–	160–205–250	0,12–0,18–0,25	< 6	XCU2500
K	Cast Iron	250	100–175–250	0,10–0,20–0,30	< 6	ACU2500
						ACK200
						ACK300
S	Exotic Alloy	–	30–50–80	0,10–0,20–0,30	< 6	XCU2500
						ACK200
						ACK300

## ■ Application Examples

Work piece	Breaker	Sumitomo	Comp.
Workpiece material: Steel (HRB 269-330)	Breaker	G	
	Grade	ACP200	
	$v_c$ (m/min)	226	200
	$v_f$ (mm/min)	1260	
	$f_z$ (mm/t)	0,28	0,2
	$a_p$ (mm)	2	2
	$a_e$ (mm)	5	5
	Dry or Wet	Wet	Wet
	Tool diam. Ø	80	
	No. of Teeth	5	
	Result	Efficiency: 158 % achieved	
	Evaluation	Wear resistance, efficiency	

Work piece	Breaker	Sumitomo	Comp.
Workpiece material: S235 (Carbon steel) Face milling	Breaker	G	
	Grade	ACP200	
	$v_c$ (m/min)	180	180
	$v_f$ (mm/min)	1092	910
	$f_z$ (mm/t)	0,3	0,2
	$a_p$ (mm)	2 x 2 mm	2 x 2 mm
	$a_e$ (mm)	50	50
	Dry or Wet	Dry	Dry
	Tool diam. Ø	63 mm	63 mm
	No. of Teeth	4	5
	Result	Efficiency: 120 % achieved	
	Evaluation	Wear resistance, efficiency	

Work piece	Breaker	Sumitomo	Comp.
Workpiece material: Cast Iron	Breaker	G	
	Grade	ACP200	
	$v_c$ (m/min)	156	156
	$v_f$ (mm/min)	536	404
	$f_z$ (mm/t)	0,17	0,09
	$a_p$ (mm)	2,2	2,2
	$a_e$ (mm)	63,5	63,5
	Dry or Wet	Dry	Dry
	Tool diam. Ø	80 mm	80 mm
	No. of Teeth	5	7
	Result	Efficiency: 133 % achieved Tool life: 138 % achieved	
	Evaluation	Efficiency, tool life	

Work piece	Breaker	Sumitomo	Comp.
Workpiece material: Cr-Mo alloy	Breaker	G	
	Grade	ACP200	
	$v_c$ (m/min)	200	200
	$v_f$ (mm/min)	838	838
	$f_z$ (mm/t)	0,2	0,13
	$a_p$ (mm)	6	6
	$a_e$ (mm)	43	43
	Dry or Wet	Dry	Dry
	Tool diam. Ø	80 mm	80 mm
	No. of Teeth	5	8
	Result	Efficiency: 120 % achieved	
	Evaluation	Efficiency	

# "Wave Mill" Series

## WFX Type

Expansion



### General Features

Wave Mill WFX type for shoulder milling is a screw-locking type cutter capable of using four corners. Ideal cutting edge design delivers good squareness. Series expansion with the high-feed **WFXH** type and the **WFXC** type for chamfering. A comprehensive lineup that covers a wide variety of applications.

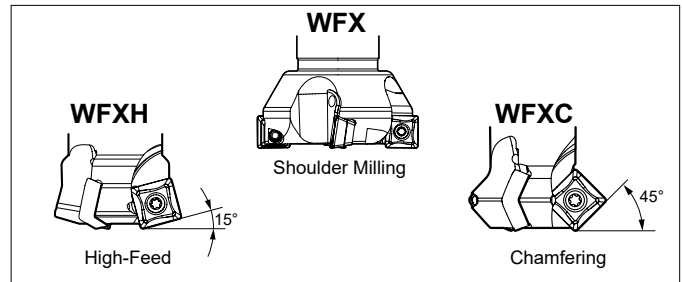

### Characteristics

The insert shape, optimized for shoulder milling and combined with a high-precision body, leaves a superior machined surface finish.



### Max. Depth of Cut

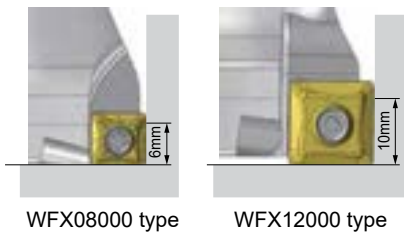

### Optimized Edge Shape

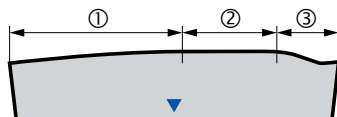

- ① The convex shape ensures the cutting edge strength.
- ② The flat shape minimises differences in step levels.

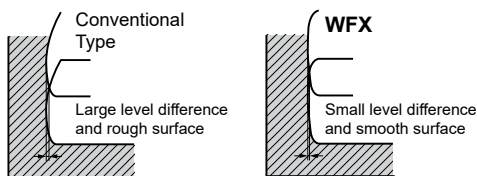

- ③ The wiper edge function improves the surface roughness.

### Product Range

Application	Type	Cat. No.	No. of Teeth	Cutter Diameter (mm)	Shape
Shoulder Milling	Shell Type	WFX 08000 RS	3 - 8	40-100	
		WFXM 08000 RS	4 - 10	40-100	
		WFXF 08000 RS	6 - 12	40-100	
		WFX 08000 R	6 - 8	80-100	
		WFXM 08000 R	8 - 10	80-100	
		WFXF 08000 R	10 - 12	80-100	
		WFX 12000 RS	3 - 5	60-100	
		WFXF 12000 RS	4 - 7	60-100	
		WFX 12000 R	4 - 12	80-250	
		WFXF 12000 R	6 - 18	80-250	
Shoulder Milling	Endmill Type	WFX 08000 E	2 - 5	20-63	
		WFXM 08000 E	3 - 6	25-63	
		WFX 12000 E	3 - 4	40-80	
		WFXF 12000 E	4 - 6	60-80	
Shoulder Milling	Modular Type	WFX 08000 M	2 - 3	20-40	
		WFXH 08000 RS	4 - 6	40-63	
		WFXH 12000 RS	4 - 5	60-63	
		WFXH 08000 M	2 - 3	25-32	
High Efficiency	Modular Type	WFXH 12000 M	3	40	
		WFXH 12000 M	3	40	
Chamfering	Endmill Type	WFXC 08000 E	1 - 2	8-16	
		WFXC 12000 E	3	25-32	
		WFXC 08000 M	2	16	
		WFXC 12000 M	3	25-32	

### Inserts

Cat. No.	RE0,2	RE0,4	RE0,8	RE1,2	RE1,6
SOMT 0803_PZER-L		●	●		
0803_PZER-G		●	●	●	
0803_PZER-H			●	●	
SOET 0803_PZER-G		●	●	●	
0803_PZFR-S	●	●	●		
SOMT 1204_PDPER-L			●		
1204_PDPER-G		●	●	●	●
1204_PDPER-H			●		
SOET 1204_PDFR-S			●		



## ■ Cutting Performance

### Squareness of Machined Shoulder

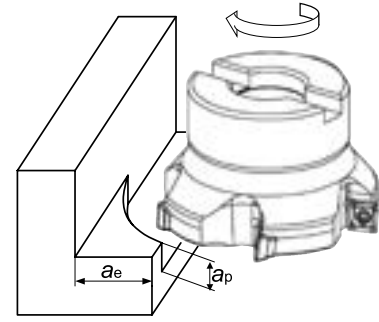
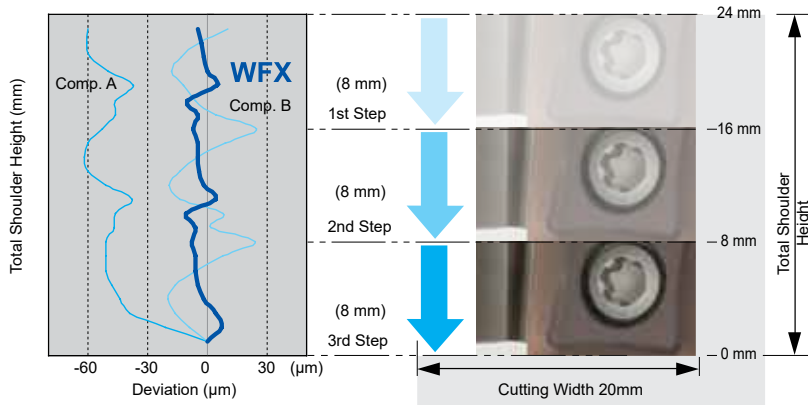

Work Material: C50  
Tool: WFX12100RS (Ø 100 mm x 5 teeth)  
Cutting Conditions:  $v_c = 200$  m/min,  $a_p = 8,0$  mm x 3 times  
 $f_z = 0,15$  mm/t,  $a_e = 20$  mm

### Comparison of Surface Roughness

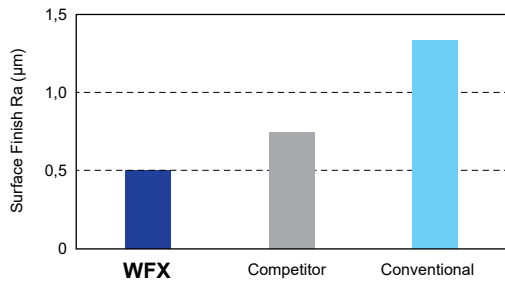

Work Material: 42CrMo4  
Tool: WFX12100RS (Ø 100 mm x 5 teeth)  
Cutting Conditions:  $v_c = 200$  m/min,  $a_p = 3,0$  mm  
 $f_z = 0,10$  mm/t,  $a_e = 90$  mm

### Comparison of Cutting Force

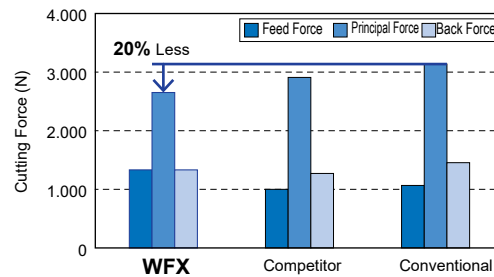

Work Material: C50  
Tool: WFX12100R (Ø 100 mm x 5 teeth)  
Cutting Conditions:  $v_c = 200$  m/min,  $a_p = 10$  mm,  
 $f_z = 0,15$  mm/t,  $a_e = 20$  mm

## ■ Chipbreaker Selection

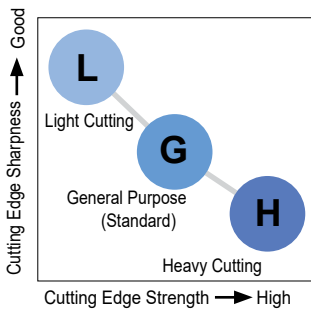

Work Material	P M K S				N
	L Type	G Type	H Type	Wiper Type	S Type
Breaker					
Characteristic	Low Cutting Force	General Purpose	Strong Edge	Wiper Edge	Sharp Edge
08 Type Cross Section	0,05 mm 20°	0,1 mm 15°	0,15 mm 10°	0,18 mm 15°	25°
12 Type Cross Section	0,05 mm 25°	0,1 mm 15°	0,2 mm 15°	0,2 mm 15°	27°
Work Material-Application	Light Cutting Low rigidity Milling Low-Burr Design	<b>Main Chipbreaker</b> General to Interrupted Milling	Heavy Cut Heavy Interrupted Machining Tempered Steel	Precision Finishing	Non-Ferrous Metal

## ■ Wiper Insert

Optimised wiper edge shape provides superior surface roughness.

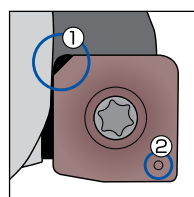
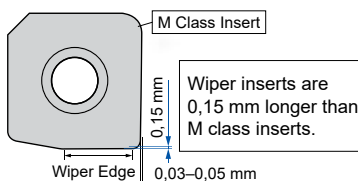

Wiper inserts are single-cornered. Attach the wiper insert so that the chamfered corner is in location ① shown in the figure. Be sure to use the corner with the ID mark (② in the figure). (08 size inserts have no marks)

# "Wave Mill" Series

## WFX(M/F) 08000 RS

Expansion

### Body - Shell Type

Rake Angle	Radial	-6°	6 mm	90°
	Axial	12°		



WFX08000RS



WFXM08000RS



WFXF08000RS

Fig. 1

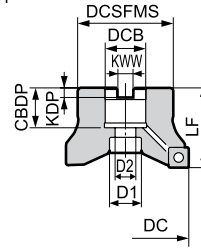
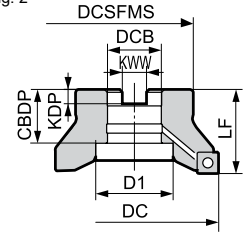

Fig. 2



### Body - WFX, Standard Pitch

Cat. No.	Stock	Dimensions (mm)									No. of Teeth	Weight (kg)	Figure
		DC	DCSFMS	LF	DCB	KWW	KDP	CBDP	D1	D2			
WFX 08040 RS	●	40	33	40	16	8,4	5,6	18	14	9	3	0,2	1
08050 RS	●	50	41	40	22	10,4	6,3	20	18	11	4	0,3	1
08063 RS	●	63	50	40	22	10,4	6,3	20	18	11	5	0,6	1
08080 RS	●	80*	55	50	27	12,4	7,0	25	20	14	6	1,0	1
WFX 08100 RS	●	100*	70	50	32	14,4	8,0	32	46	-	8	1,4	2

### Body - WFXM, Medium Pitch

Cat. No.	Stock	Dimensions (mm)									No. of Teeth	Weight (kg)	Figure
		DC	DCSFMS	LF	DCB	KWW	KDP	CBDP	D1	D2			
WFXM 08040 RS	●	40	33	40	16	8,4	5,6	18	14	9	4	0,2	1
08050 RS	●	50	41	40	22	10,4	6,3	20	18	11	5	0,3	1
08063 RS	●	63	50	40	22	10,4	6,3	20	18	11	6	0,5	1
08080 RS	●	80*	55	50	27	12,4	7,0	25	20	14	8	1,0	1
WFXM 08100 RS	●	100*	70	50	32	14,4	8,0	32	46	-	10	1,4	2

### Body - WFXF, Fine Pitch

Cat. No.	Stock	Dimensions (mm)									No. of Teeth	Weight (kg)	Figure
		DC	DCSFMS	LF	DCB	KWW	KDP	CBDP	D1	D2			
WFXF 08040 RS	●	40	33	40	16	8,4	5,6	18	14	9	6	0,2	1
08050 RS	●	50	41	40	22	10,4	6,3	20	18	11	7	0,3	1
08063 RS	●	63	50	40	22	10,4	6,3	20	18	11	8	0,5	1
08080 RS	●	80*	55	50	27	12,4	7,0	25	20	14	10	0,9	1
WFXF 08100 RS	●	100*	70	50	32	14,4	8,0	32	46	-	12	1,4	2

Inserts are not included.

\*Please use JIS B1176 hexagonal bolt (Ø80: M12x30~35mm, Ø100: M16x40~45mm) for securing Ø80 / Ø100 cutter on the arbor.

### Recommended Cutting Conditions

ISO	Work Material	Hardness (HB)	Cutting Speed	Feed Rate	DOC	Grades
P	General Steel	180-280	150-200-250	0,08-0,12-0,18	<6	ACU2500 ACP200
	Soft Steel	≤180	180-250-350	0,10-0,15-0,20	<6	ACP300 XCU2500
	Die Steel	200-220	100-150-200	0,08-0,12-0,18	<4	XCU2500
M	Stainless Steel	-	160-200-250	0,10-0,15-0,20	<6	ACU2500 ACM300
K	Cast Iron	250	100-175-250	0,10-0,15-0,20	<6	ACU2500 ACK200 ACK300
						XCU2500 XCK2000
						H1 DL1000
N	Non Ferrous Metal	-	300-500-1000	0,10-0,15-0,20	<6	ACU2500
S	Exoric Alloy	-	30-50-80	0,08-0,13-0,18	<6	ACM200 ACM300

Min. - Optimum - Max.

### Identification Details

<b>WFX</b>	<b>F</b>	<b>08</b>	<b>040</b>	<b>R</b>	<b>S</b>
Cutter Series	M: Medium Pitch F: Fine Pitch	Insert Size	Cutter Diameter	Direction	Metric Type

### Spare Parts

Screw	Wrench
BFTX03061P	TRDR081P
2,0	

### Inserts

Dimensions (mm)

Application	Coated Carbide										Carbide	DLC			
High Speed / Light cut	P	P	P	P	P	P	P	P	P	P	K	K	N	N	
General Purpose	P	P	P	P	P	P	P	P	P	P	K	K	M	M	N
Roughing	P	P	P	P	P	P	P	P	P	P	K	K	M	M	S
Cat. No.	ACU2500	XCU2500	ACP100	ACP200	ACP300	XCK2000	ACK200	ACK300	ACM200	ACM300	H1	DL1000	RE	Fig.	
SOMT 080304 PZER L	●	○	○	○	○	○	○	○	○	○	-	-	0,4	3	
080308 PZER L	●	○	○	○	○	○	○	○	○	○	-	-	0,8	3	
SOMT 080304 PZER G	●	○	○	○	○	○	○	○	○	○	-	-	0,4	3	
080308 PZER G	●	○	○	○	○	○	○	○	○	○	-	-	0,8	3	
080312 PZER G	●	○	○	○	○	○	○	○	○	○	-	-	1,2	3	
SOMT 080308 PZER H	●	○	○	○	○	○	○	○	○	○	-	-	0,8	3	
080312 PZER H	●	○	○	○	○	○	○	○	○	○	-	-	1,2	3	
SOET 080304 PZER G	●	○	○	○	○	○	○	○	○	○	-	-	0,4	3	
080308 PZER G	●	○	○	○	○	○	○	○	○	○	-	-	0,8	3	
080312 PZER G	●	○	○	○	○	○	○	○	○	○	-	-	1,2	3	
SOET 080302 PZFR S	-	-	-	-	-	-	-	-	-	-	●	●	0,2	3	
080304 PZFR S	-	-	-	-	-	-	-	-	-	-	●	●	0,4	3	
080308 PZFR S	-	-	-	-	-	-	-	-	-	-	●	●	0,8	3	
XOEW 080308 PZTR W	●	-	-	-	-	-	-	-	-	-	-	-	0,8	4	

Fig. 3

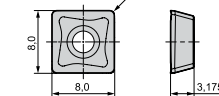
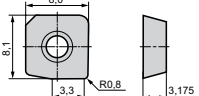

Fig. 4

Wiper Insert







# "Wave Mill" Series WFX(F) 12000 RS

## ■ Body - Shell Type

Rake Angle	Radial	-8°	10 mm	90°
	Axial	8°		



WFX 12000RS

WFXF12000RS

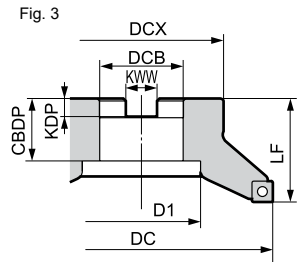
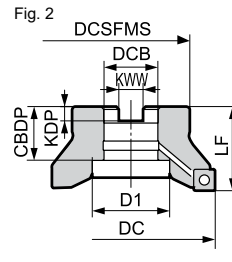
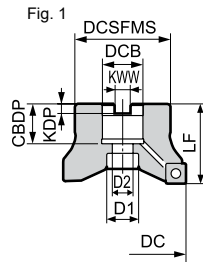

## ● Body - WFX, Standard Pitch

Cat. No.	Stock	Dimensions (mm)									No. of Teeth	Weight (kg)	Figure
		DC	DCSFMS	LF	DCB	KWW	KDP	CBDP	D1	D2			
WFX 12050 RS	●	50	40	40	22	10,4	6,3	20	18	11	3	0,2	1
12063 RS	●	63	50	40	22	10,4	6,3	20	18	11	4	0,4	1
12080 RS	●	80*	60	50	27	12,4	7,0	25	20	13,5	4	0,9	1
WFX 12100 RS	●	100*	70	50	32	14,4	8,5	32	46	-	5	1,3	2
12125 RS	●	125	90	63	40	16,4	9,5	29	52	-	6	2,7	2
12160 RS	●	160	130	63	40	16,4	9,5	29	88	-	8	4,8	3

## ● Body - WFXF, Fine Pitch

Cat. No.	Stock	Dimensions (mm)									No. of Teeth	Weight (kg)	Figure
		DC	DCSFMS	LF	DCB	KWW	KDP	CBDP	D1	D2			
WFXF 12050 RS	●	50	40	40	22	10,4	6,3	20	18	11	4	0,2	1
12063 RS	●	63	50	40	22	10,4	6,3	20	18	11	5	0,4	1
12080 RS	●	80*	60	50	27	12,4	7,0	25	20	13,5	6	0,9	1
WFXF 12100 RS	●	100*	70	50	32	14,4	8,5	32	46	-	7	1,2	2
12125 RS	●	125	90	63	40	16,4	9,5	29	52	-	8	2,6	2
12160 RS	●	160	130	63	40	16,4	9,5	29	88	-	12	4,7	3

Inserts are not included.  
\*Please use JIS B1176 hexagonal bolt (Ø80: M12x30~35mm, Ø100: M16x40~45mm) for securing Ø80 / Ø100 cutter on the arbor.  
Cutters ≥ Ø160 do not have coolant holes.

## ■ Recommended Cutting Conditions

ISO	Work Material	Hardness (HB)	Cutting Speed	Feed Rate	DOC	Grades
P	General Steel	180-280	150-200-250	0,10-0,15-0,20	<10	ACU2500
	Soft Steel	≤180	180-250-350	0,10-0,15-0,20	<10	ACP200 ACP300 XCU2500
	Die Steel	200-220	100-150-200	0,10-0,15-0,20	<6	ACU2500
M	Stainless Steel	-	160-200-250	0,10-0,15-0,20	<10	ACU2500 ACM300
K	Cast Iron	250	100-175-250	0,10-0,15-0,20	<10	ACU2500 ACK200 ACK300 XCU2500 XCK2000
N	Non Ferrous Metal	-	300-500-1000	0,10-0,15-0,20	<10	H1 DL1000
S	Exotic Alloy	-	30-50-80	0,10-0,15-0,20	<10	ACU2500 ACM200 ACM300

Min. - Optimum - Max.

## ■ Identification Details

<b>WFX</b>	<b>F</b>	<b>12</b>	<b>050</b>	<b>R</b>	<b>S</b>
Cutter Series	F: Fine Pitch	Insert Size	Cutter Diameter	Direction	Metric Type

## ■ Spare Parts

Shim	Shim Screw	Insert Screw	Insert Wrench	Wrench (Shim)
WFXS4R	BW0507F	BFTX03512IP	3,0 TRDR15IP	LH035

## ■ Inserts

Application	Coated Carbide								Carbide		DLC			
	ACU2500	XCU2500	ACP100	ACP200	ACP300	XCK2000	ACK200	ACK300	ACM200	ACM300	H1	DL1000	RE	Fig.
High Speed / Light cut	●	●	●	●	●	●	●	●	●	●	●	●	●	●
General Purpose	●	●	●	●	●	●	●	●	●	●	●	●	●	●
Roughing	●	●	●	●	●	●	●	●	●	●	●	●	●	●
Cat. No.	ACU2500	XCU2500	ACP100	ACP200	ACP300	XCK2000	ACK200	ACK300	ACM200	ACM300	H1	DL1000	RE	Fig.
SOMT 120408 PDER L	●	○	○	○	○	○	○	○	○	○	○	○	○	0,8 3
SOMT 120404 PDER G	●	○	○	○	○	○	○	○	○	○	○	○	○	0,4 3
120408 PDER G	●	○	○	○	○	○	○	○	○	○	○	○	○	0,8 3
120412 PDER G	●	○	○	○	○	○	○	○	○	○	○	○	○	1,2 3
120416 PDER G	●	○	○	○	○	○	○	○	○	○	○	○	○	1,6 3
SOMT 120408 PDER H	●	○	○	○	○	○	○	○	○	○	○	○	○	0,8 3
SOET 120408 PDFR S	-	-	-	-	-	-	-	-	-	-	●	●	●	0,8 3
XOEW 120408 PDTR W	●	-	-	-	-	-	-	-	-	-	-	-	-	4

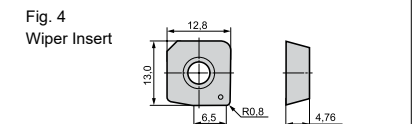
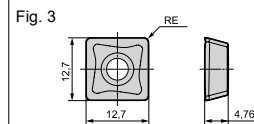

Milling Cutters



# "Sumi Dual Mill" Series TSX Type

Expansion



## General Features



High-efficient and high precision tangential shoulder milling cutter with tangentially mounted carbide inserts.

## Characteristics

- **Tough & Sharp cutting edge**  
Tangentially mounted carbide insert design and optimized edge geometry realize extremely tough and sharp cutting action.
- **Very accurate and excellent surface finish**  
Thanks to newly developed fine carbide press / sintering technology and very accurate grinding technics, very periphery ground inserts generate very accurate and excellent surface finish.
- **Wide product range**  
2 different insert size series, 3 chip breaker range and various carbide grade combination offers wide range of machining application.

## Product Range

### Shoulder Milling Cutter



	Cat. No.	Series	Diameter Range / No of Teeth													Shape		
			Ø16	Ø20	Ø25	Ø32	Ø40	Ø50	Ø63	Ø80	Ø100	Ø125	Ø160	Ø200	Ø250		Ø315	
Shell Type	TSX 08000RS	Standard Pitch					4	5	6	7								
	TSXF 08000RS	Fine Pitch					6	8	10	11								
	TSX 13000RS	Standard Pitch					3	4	5	5	6	7	8	12	14	16		
	TSXM 13000RS	Medium Pitch					4	5	6	7	8	10	12	16	20	24		
	TSXF 13000RS	Fine Pitch					5	6	7	8	10	14	16					
Shank Type	TSX 08000E	Standard Pitch	2	2*	3*	3*	4	5	6	7								
	TSXF 08000E	Fine Pitch		3	4	5	6	8	10	11								
	TSX 13000E	Standard Pitch			2	2	3	4	5	5								
	TSXM 13000E	Medium Pitch				3	4	5	6	7								
	TSXF 13000E	Fine Pitch					5	6	7	8								

→ H20-23

\* Different shank diameters in stock

## TSXR - Repeater







New

Type	Cat. No.	Diameter Range / No of Teeth											Shape				
		Ø16	Ø20	Ø25	Ø32	Ø40	Ø50	Ø63	Ø80	Ø100	Ø125						
Shell	TSXR 08000RS				2	3	3	4	5								
	TSXR 13000RS					2	3		3	4	4	5	5	6	7		
Shank	TSXR 08000E		1	2	2	3											
	TSXR 13000E					2	3										

→ H24-25

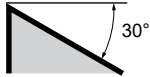
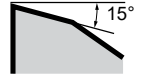
● = Euro stock

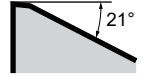
## ■ Chipbreaker Lineup

Work Material	P M K S		
	L type	G type	H type
Chipbreaker			
Feature	Low cutting force	General purpose	Strong edge
LNEX08 Cutting edge geometry			—
LNEX13 Cutting edge geometry			
Application	Light cut, low rigidity milling and reduced burrs	Main breaker for general purpose applications	Roughing, heavy interrupted and hardness steel milling

## ■ Chipbreaker Selection

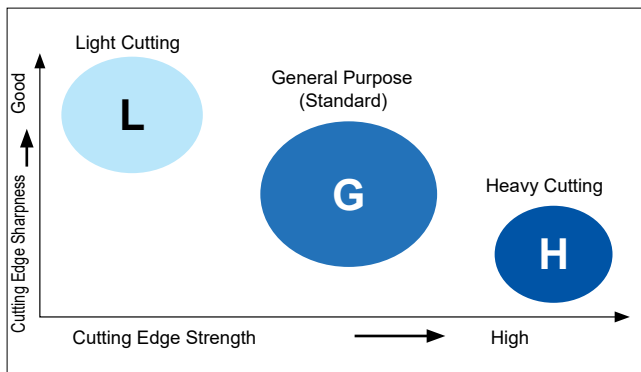

## ■ Inserts

Cat. No.	RE0,4	RE0,8	RE1,2	RE1,6	RE2,4	RE3,2
LNEX0804__PNER-L	●	●				
LNEX0804__PNER-G	●	●	●	●		
LNEX1306__PNER-L	●	●				
LNEX1306__PNER-G		●		●	●	●
LNEX1306__PNER-H	●	●		●	●	●

## ■ Suitable Applications

Face milling

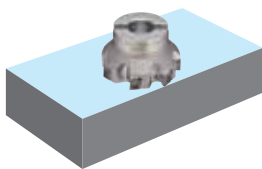

Shoulder milling

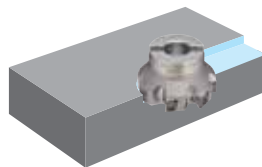

Side face milling

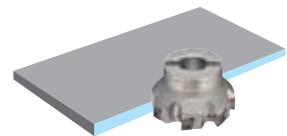

Slot milling

Recommended  
≤ ø32 mm

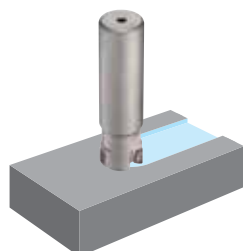

Hole expansion milling

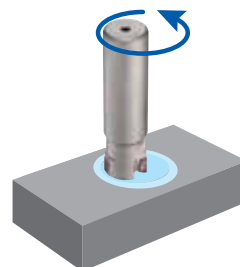

# "Sumi Dual Mill" Series TSX Type

## ■ Toughness

TSX type has extremely stable cutting edge.

Cutting Length	4 Passes	8 Passes	12 Passes
TSX	Available		
Competitor A	Breakage		
Competitor B	Breakage		

  

Machine:	M/C BT-50, vertical	Work Material:	C50
Tool:	TSX13100RS	Insert:	LNEX130608PNER-G (ACP200)
Cutting Conditions:			
$v_c = 150$ m/min, $f_z = 0,6$ mm/t, $a_p = 3$ mm, $a_e = 40$ mm, dry			

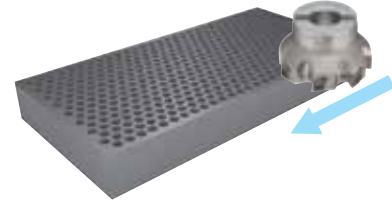

## ■ Squareness of Machined Shoulder

TSX type shows excellent squareness due to ground insert and optimized design.

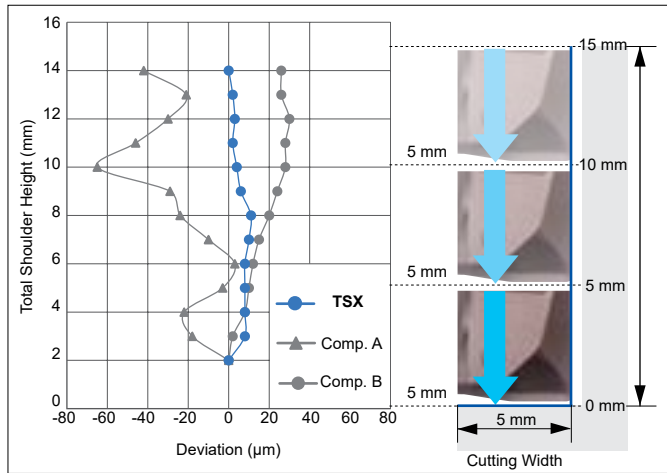

Machine:	M/C BT-50, vertical	Work Material:	Carbon Steel
Tool:	TSX13100RS	Insert:	LNEX130608PNER-G (ACP200)
Cutting Conditions:			
$v_c = 200$ m/min, $f_z = 0,2$ mm/t, $a_p = 5$ mm x 3 passes, $a_e = 5$ mm, dry			

## ■ Surface Finish

TSX type shows excellent surface roughness.

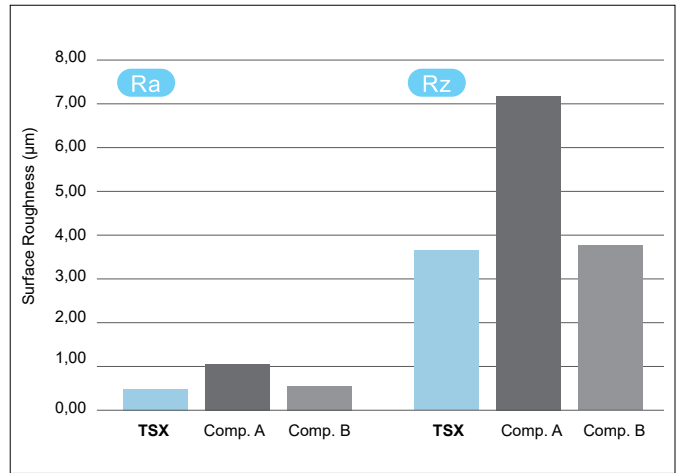

Machine:	M/C BT-50, vertical	Work Material:	C50
Tool:	TSX13100RS	Insert:	LNEX130608PNER-G (ACP200)
Cutting Conditions:			
$v_c = 200$ m/min, $f_z = 0,2$ mm/t, $a_p = 3$ mm, $a_e = 60$ mm, dry			

## ■ Tool Life

Longer tool life and stability due to superior wear resistance.

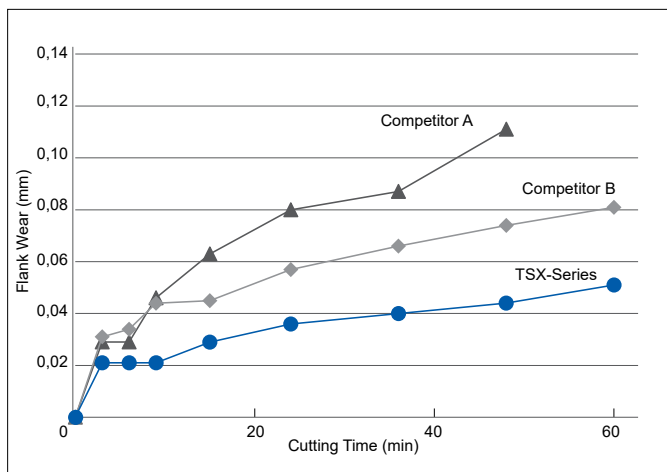

Machine:	M/C BT-50, vertical	Work Material:	C50
Tool:	TSX08025E	Insert:	LNEX080408PNER-G (ACP200)
Cutting Conditions:			
$v_c = 200$ m/min, $f_z = 0,10$ mm/t, $a_p = 2$ mm, $a_e = 5$ mm			



# "Sumi Dual Mill" Series TSX Type

## Shoulder Milling Tool Selection Guide

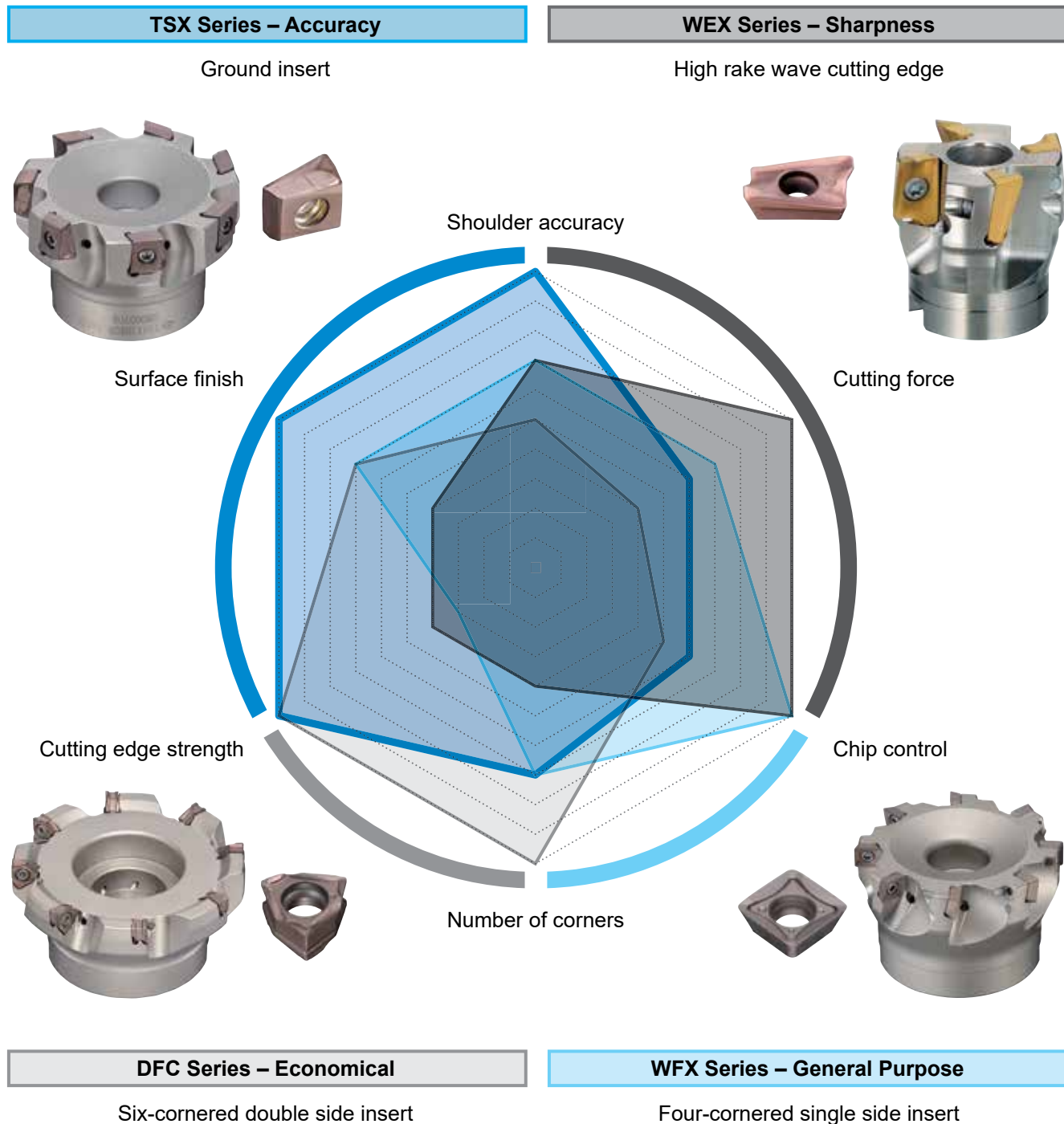

Milling Cutters

★★★ Top recommendation

	Surface Finish	Shoulder Accuracy	Cutting Force	Chip Control	Number of Corners	Cutting edge Strength
<b>TSX Series</b>	★★★	★★★	★★	★☆	★★	★★★
<b>DFC Series</b>	★★	★	★	★☆	★★★	★★★
<b>WEX Series</b>	★	★★	★★★	★★★	★	★★
<b>WFX Series</b>	★★	★★	★★	★★★	★★	★

# "Sumi Dual Mill" Series TSX(F) 08000 RS

Expansion

## ■ Body - Shell Type

Rake Angle	Radial	-20°	8 mm	90°
	Axial	-6°		

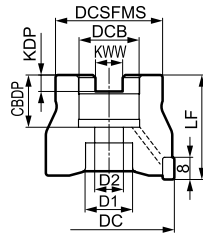

## ● Body - TSX, Standard Pitch

Cat. No.	Stock	Dimensions (mm)									No. of Teeth	Weight (kg)
		DC	DCSFMS	LF	DCB	KWW	KDP	CBDP	D1	D2		
TSX 08040 RS	●	40	33	40	16	8,4	5,6	18	14	9	4	0,21
08050 RS	●	50	41	40	22	10,4	6,3	20	18	11	5	0,30
08063 RS	●	63	50	40	22	10,4	6,3	20	18	11	6	0,53
08080 RS	●	80*	55	50	27	12,4	7,0	22	20	14	7	0,99

Check the arbor attachment size (DCB) when selecting the cutter. Inserts are not included.  
\* Please use JIS B1176 hexagonal bolt (M12x30 to 35 mm) for securing a Ø 80 mm cutter to the arbor.

## ● Body - TSXF, Fine Pitch

Cat. No.	Stock	Dimensions (mm)									No. of Teeth	Weight (kg)
		DC	DCSFMS	LF	DCB	KWW	KDP	CBDP	D1	D2		
TSXF 08040 RS	●	40	33	40	16	8,4	5,6	18	14	9	6	0,21
08050 RS	●	50	41	40	22	10,4	6,3	20	18	11	8	0,31
08063 RS	●	63	50	40	22	10,4	6,3	20	18	11	10	0,54
08080 RS	●	80*	55	50	27	12,4	7,0	22	20	14	11	0,97

Check the arbor attachment size (DCB) when selecting the cutter. Inserts are not included.  
\* Please use JIS B1176 hexagonal bolt (M12x30 to 35 mm) for securing a Ø 80 mm cutter to the arbor.

## ■ Inserts

Application	Coated Carbide										RE
	ACU2500	XCU2500	ACP100	ACP200	ACP300	XCK2000	ACK200	ACK300	ACM200	ACM300	
High Speed / Light Cutting	●	●	●	●	●	●	●	●	●	●	●
General Purpose Cutting	●	●	●	●	●	●	●	●	●	●	●
Rough Cutting	●	●	●	●	●	●	●	●	●	●	●
Cat. No.											
LNEX 080404 PNER-L	●			●	○		○	●	○	●	0,4
080408 PNER-L	●			○	○		○	○	○	○	0,8
080412 PNER-L	○			○	○		○	○	○	○	1,2
080416 PNER-L	○			○	○		○	○	○	○	1,6
LNEX 080404 PNER-G	●	○	○	●	●	○	●	●	○	●	0,4
080408 PNER-G	●	○	○	○	○	○	○	○	○	○	0,8
080412 PNER-G	○	○	○	○	○	○	○	○	○	○	1,2
080416 PNER-G	○	○	○	○	○	○	○	○	○	○	1,6

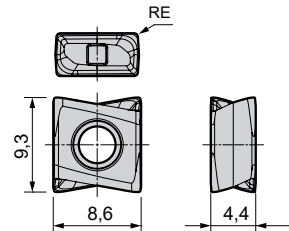

## ■ Recommended Cutting Conditions

ISO	Work-material	Hardness (HB)	Cutting Speed v <sub>c</sub> (m/min)	TSX 08000	TSX 13000	Grade
				Feed Rate f <sub>t</sub> (mm/T)	Feed Rate f <sub>t</sub> (mm/T)	
P	Carbon Steel	180-280	150-225-300	0,08-0,20-0,30	0,10-0,30-0,40	ACU2500 ACP100 ACP200 ACP300 XCU2500
		> 280	75-150-230	0,08-0,20-0,30	0,10-0,30-0,40	
	Alloy Steel	180-280	100-175-250	0,08-0,15-0,25	0,10-0,25-0,35	
M	Stainless Steel	220-280	90-135-180	0,08-0,15-0,25	0,10-0,20-0,30	ACU2500 ACM200 ACM300
		>280	75-125-170	0,08-0,15-0,25	0,10-0,20-0,30	
K	Cast Iron Ductile Cast Iron	250	100-175-250	0,08-0,20-0,30	0,10-0,30-0,40	ACU2500 ACK200 ACK300 XCU2500 XCK2000
S	Exotic Material	-	30-60-90	0,05-0,10-0,15	0,05-0,15-0,20	ACU2500 ACM200 ACM300

## ■ Identification Details

<b>TSX</b>	<b>F</b>	<b>08</b>	<b>050</b>	<b>R</b>	<b>S</b>
Cutter Series	F: Fine Pitch	Insert Size	Cutter Diameter	Direction	Metric Type

## ■ Spare Parts

Screw	Wrench
BFTX0308IP	TRDR08IP
	2,0

Recommended Tightening Torque (N·m)

● = Euro stock  
○ = Japan stock



# "Sumi Dual Mill" Series TSX 13000 RS

## Shell Type



Fig. 1

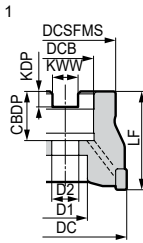

Fig. 2

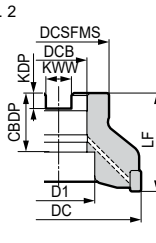

Fig. 3

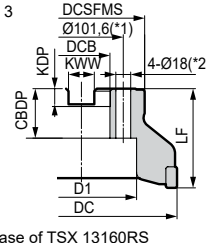
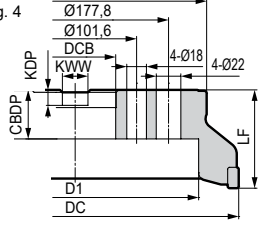

Fig. 4



In case of TSX 13160RS  
\*1: Ø 66,7 / \*2: 4-Ø 14

Rake Angle	Radial	-23° - -15°	12 mm	90°
	Axial	-6°		

## Body - TSX, Standard Pitch

Cat. No.	Stock	Dimensions (mm)									No. of Teeth	Weight (kg)	Figure
		DC	DCSFMS	LF	DCB	KWW	KDP	CBDP	D1	D2			
TSX 13040 RS	●	40	33	40	16	8,4	5,6	18	14	9	3	0,20	1
13050 RS	●	50	41	40	22	10,4	6,3	20	18	11	4	0,30	1
13063 RS	●	63	50	40	22	10,4	6,3	20	18	11	5	0,50	1
13080 RS	●	80*	55	50	27	12,4	7,0	22	20	14	5	0,92	1
13100 RS	●	100*	70	50	32	14,4	8,0	32	46	-	6	1,35	2
13125 RS	●	125	80	63	40	16,4	9,0	29	52	29	7	2,55	1
13160 RS	●	160	130	63	40	16,4	9,0	29	90	-	8	4,97	3*
13200 RS	●	200	160	63	60	25,7	14,0	35	135	-	12	6,20	3
13250 RS	●	250	180	63	60	25,7	14,0	35	160	-	14	9,35	3
13315 RS	○	315	240	63	60	25,7	14,0	35	230	-	16	16,42	4

Check the arbor attachment size (DCB) when selecting the cutter. Inserts are not included.  
\*Please use JIS B1176 hexagonal bolt (Ø 80: M12x30 to 35 mm, Ø 100: M16 x 40 to 45 mm) for securing Ø 80 / Ø 100 cutter on the arbor.

## Inserts

Application	Coated Carbide								RE		
	ACU2500	XCU2500	ACP100	ACP200	ACP300	XCK2000	ACK200	ACK300		ACM200	ACM300
High Speed / Light Cutting	●	●	●	●	●	●	●	●	●	●	
General Purpose Cutting	●	●	●	●	●	●	●	●	●	●	
Rough Cutting	●	●	●	●	●	●	●	●	●	●	
Cat. No.	ACU2500	XCU2500	ACP100	ACP200	ACP300	XCK2000	ACK200	ACK300	ACM200	ACM300	RE
LNEX 130604 PNER-L	●			●	○		○	●	○	●	0,4
130608 PNER-L	●			●	○		○	●	○	●	0,8
130612 PNER-L	○			●	○		○	●	○	○	1,2
130616 PNER-L	○			●	○		○	●	○	○	1,6
130620 PNER-L	○			○	○		○	○	○	○	2,0
130624 PNER-L	○			○	○		○	○	○	○	2,4
130632 PNER-L	○			○	○		○	○	○	○	3,2
LNEX 130604 PNER-G	●	○	●	●	●	○	●	●	○	●	0,4
130608 PNER-G	●	○	●	●	●	○	●	●	○	●	0,8
130612 PNER-G	○		●	●	●		●	●	○	●	1,2
130616 PNER-G	●		○	●	●		●	●	○	●	1,6
130620 PNER-G	○		○	○	○		○	○	○	○	2,0
130624 PNER-G	●		○	●	●		●	●	○	●	2,4
130632 PNER-G	●		○	●	●		●	●	○	●	3,2
LNEX 130604 PNER-H	○			○	○		○	○			0,4
130608 PNER-H	○	○			○		○	○			0,8
130612 PNER-H	○			●	●		●	●			1,2
130616 PNER-H	●			●	●		●	●			1,6
130620 PNER-H	○			○	○		○	○			2,0
130624 PNER-H	●			●	●		●	●			2,4
130632 PNER-H	●			●	●		●	●			3,2

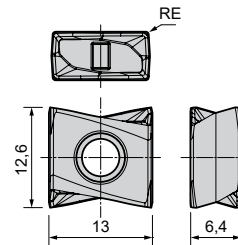

## Recommended Cutting Conditions

→ G34

## Identification Details

<b>TSX</b>	<b>13</b>	<b>100</b>	<b>R</b>	<b>S</b>
Cutter Series	Insert Size	Cutter Diameter	Direction	Metric Type

## Spare Parts

Screw	Wrench
BFTX03510IP	TRDR15IP
3,0	



# "Sumi Dual Mill" Series TSXM 13000 RS

Expansion

## Shell Type

Rake Angle	Radial	-23° ~ -15°	12 mm	90°
	Axial	-6°		



Fig. 1

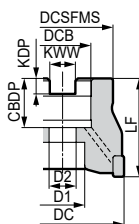

Fig. 2

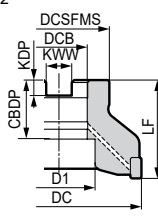
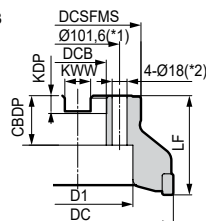
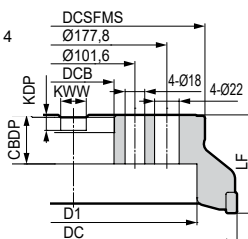

Fig. 3



In case of TSX 13160RS  
\*1: Ø66,7 / \*2: 4-Ø14

Fig. 4



## Body - TSXM, Medium Pitch

Cat. No.	Stock	Dimensions (mm)									No. of Teeth	Weight (kg)	Figure
		DC	DCSFMS	LF	DCB	KWW	KDP	CBDP	D1	D2			
TSXM 13040 RS	●	40	33	40	16	8,4	5,6	18	14	9	4	0,19	1
13050 RS	●	50	41	40	22	10,4	6,3	20	18	11	5	0,28	1
13063 RS	●	63	50	40	22	10,4	6,3	20	18	11	6	0,50	1
13080 RS	●	80*	55	50	27	12,4	7,0	22	20	14	7	0,92	1
13100 RS	●	100*	70	50	32	14,4	8,0	32	46	-	8	1,36	2
13125 RS	●	125	80	63	40	16,4	9,0	29	52	29	10	2,57	1
13160 RS	●	160	130	63	40	16,4	9,0	29	90	-	12	5,02	3*
13200 RS	●	200	160	63	60	25,7	14,0	35	135	-	16	6,32	3
13250 RS	●	250	180	63	60	25,7	14,0	35	160	-	20	9,42	3
13315 RS	○	315	240	63	60	25,7	14,0	35	230	-	24	16,37	4

Check the arbor attachment size (DCB) when selecting the cutter. Inserts are not included.  
\*Please use JIS B1176 hexagonal bolt (Ø 80: M12x30 to 35 mm, Ø 100: M16 x 40 to 45 mm) for securing Ø 80 / Ø 100 cutter on the arbor.

## Inserts

Dimensions (mm)

Application	Coated Carbide								RE		
	ACU2500	XCU2500	ACP100	ACP200	ACP300	XCK2000	ACK200	ACK300		ACM200	ACM300
High Speed / Light Cutting	●	●	●	●	●	●	●	●	●	●	●
General Purpose Cutting	●	●	●	●	●	●	●	●	●	●	●
Rough Cutting	●	●	●	●	●	●	●	●	●	●	●
Cat. No.	ACU2500	XCU2500	ACP100	ACP200	ACP300	XCK2000	ACK200	ACK300	ACM200	ACM300	RE
LNEX 130604 PNER-L	●	○	○	●	○	○	○	○	○	○	0,4
130608 PNER-L	●	○	○	●	○	○	○	○	○	○	0,8
130612 PNER-L	○	○	○	●	○	○	○	○	○	○	1,2
130616 PNER-L	○	○	○	●	○	○	○	○	○	○	1,6
130620 PNER-L	○	○	○	○	○	○	○	○	○	○	2,0
130624 PNER-L	○	○	○	○	○	○	○	○	○	○	2,4
130632 PNER-L	○	○	○	○	○	○	○	○	○	○	3,2
LNEX 130604 PNER-G	●	○	○	●	○	○	○	○	○	○	0,4
130608 PNER-G	●	○	○	●	○	○	○	○	○	○	0,8
130612 PNER-G	○	○	○	●	○	○	○	○	○	○	1,2
130616 PNER-G	○	○	○	●	○	○	○	○	○	○	1,6
130620 PNER-G	○	○	○	○	○	○	○	○	○	○	2,0
130624 PNER-G	○	○	○	○	○	○	○	○	○	○	2,4
130632 PNER-G	○	○	○	○	○	○	○	○	○	○	3,2
LNEX 130604 PNER-H	○	○	○	○	○	○	○	○	○	○	0,4
130608 PNER-H	○	○	○	○	○	○	○	○	○	○	0,8
130612 PNER-H	○	○	○	○	○	○	○	○	○	○	1,2
130616 PNER-H	○	○	○	○	○	○	○	○	○	○	1,6
130620 PNER-H	○	○	○	○	○	○	○	○	○	○	2,0
130624 PNER-H	○	○	○	○	○	○	○	○	○	○	2,4
130632 PNER-H	○	○	○	○	○	○	○	○	○	○	3,2

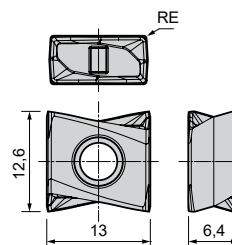

## Recommended Cutting Conditions

→ G34

## Identification Details

<b>TSX</b>	<b>M</b>	<b>13</b>	<b>100</b>	<b>R</b>	<b>S</b>
Cutter Series	M: Medium Pitch	Insert Size	Cutter Diameter	Direction	Metric Type

## Spare Parts

Screw	Wrench
BFTX03510IP	TRDR15IP

Recommended Tightening Torque (N·m)

## Shell Type



Fig. 1

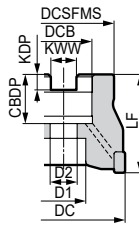

Fig. 2

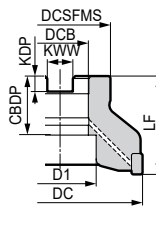
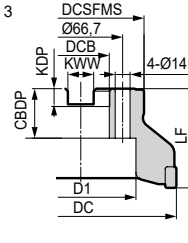

Fig. 3



Rake Angle	Radial	-23° - -15°	12 mm	90°
	Axial	-6°		

## Body - TSXF, Fine Pitch

Cat. No.	Stock	Dimensions (mm)										No. of Teeth	Weight (kg)	Figure
		DC	DCSFMS	LF	DCB	KWW	KDP	CBDP	D1	D2				
TSXF 13040 RS	●	40	33	40	16	8,4	5,6	18	14	9	5	0,18	1	
13050 RS	●	50	41	40	22	10,4	6,3	20	18	11	6	0,29	1	
13063 RS	●	63	50	40	22	10,4	6,3	20	18	11	7	0,50	1	
13080 RS	●	80*	55	50	27	12,4	7,0	22	20	14	8	0,92	1	
13100 RS	●	100*	70	50	32	14,4	8,0	32	46	-	10	1,34	2	
13125 RS	●	125	80	63	40	16,4	9,0	29	52	29	14	2,58	1	
13160 RS	●	160	130	63	40	16,4	9,0	29	90	-	16	5,08	3	

Check the arbor attachment size (DCB) when selecting the cutter. Inserts are not included.  
\*Please use JIS B1176 hexagonal bolt (Ø 80: M12x30 to 35 mm, Ø 100: M16 x 40 to 45 mm) for securing Ø 80 / Ø 100 cutter on the arbor.

## Inserts

Dimensions (mm)

Application	Coated Carbide								RE		
	ACU2500	XCU2500	ACP100	ACP200	ACP300	XCK2000	ACK200	ACK300		ACM200	ACM300
High Speed / Light Cutting	●	●	●	●	●	●	●	●	●	●	●
General Purpose Cutting	●	●	●	●	●	●	●	●	●	●	●
Rough Cutting	●	●	●	●	●	●	●	●	●	●	●
Cat. No.	ACU2500	XCU2500	ACP100	ACP200	ACP300	XCK2000	ACK200	ACK300	ACM200	ACM300	RE
LNEX 130604 PNER-L	●	○	○	●	○	○	○	○	○	○	0,4
130608 PNER-L	●	○	○	●	○	○	○	○	○	○	0,8
130612 PNER-L	○	○	○	○	○	○	○	○	○	○	1,2
130616 PNER-L	○	○	○	○	○	○	○	○	○	○	1,6
130620 PNER-L	○	○	○	○	○	○	○	○	○	○	2,0
130624 PNER-L	○	○	○	○	○	○	○	○	○	○	2,4
130632 PNER-L	○	○	○	○	○	○	○	○	○	○	3,2
LNEX 130604 PNER-G	●	○	○	●	○	○	○	○	○	○	0,4
130608 PNER-G	●	○	○	●	○	○	○	○	○	○	0,8
130612 PNER-G	○	○	○	○	○	○	○	○	○	○	1,2
130616 PNER-G	●	○	○	○	○	○	○	○	○	○	1,6
130620 PNER-G	○	○	○	○	○	○	○	○	○	○	2,0
130624 PNER-G	●	○	○	○	○	○	○	○	○	○	2,4
130632 PNER-G	●	○	○	○	○	○	○	○	○	○	3,2
LNEX 130604 PNER-H	○	○	○	○	○	○	○	○	○	○	0,4
130608 PNER-H	○	○	○	○	○	○	○	○	○	○	0,8
130612 PNER-H	○	○	○	○	○	○	○	○	○	○	1,2
130616 PNER-H	○	○	○	○	○	○	○	○	○	○	1,6
130620 PNER-H	○	○	○	○	○	○	○	○	○	○	2,0
130624 PNER-H	○	○	○	○	○	○	○	○	○	○	2,4
130632 PNER-H	○	○	○	○	○	○	○	○	○	○	3,2

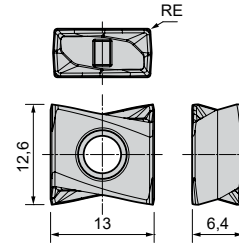

## Recommended Cutting Conditions

→ G34

## Identification Details

<b>TSX</b>	<b>F</b>	<b>13</b>	<b>100</b>	<b>R</b>	<b>S</b>
Cutter Series	F: Fine Pitch	Insert Size	Cutter Diameter	Direction	Metric Type

## Spare Parts

Screw	Wrench
BFTX03510IP	TRDR15IP

# "Sumi Dual Mill" Series TSXR 08000 RS

Expansion

Repeater

## Shell Type

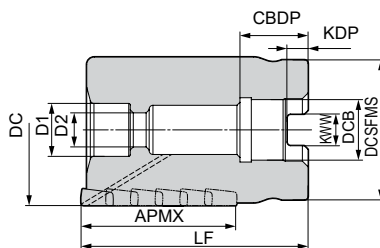

Rake Angle	Radial	-20° - -15°	34-60 mm 90°
	Axial	-6° - -3°	

## Body - TSXR

Cat. No.	Stock	Dimensions (mm)										No. of Teeth	Steps	Effective Teeth
		DC	APMX	DCSFMS	LF	DCB	KWW	KDP	CBDP	D1	D2			
TSXR 08032RS3416Z02	○	32	34	33	55	16,0	8,4	5,6	18,0	14	9	10	5	2
08040RS4016Z03	○	40	40	37	60	16,0	8,4	5,6	18,0	14	9	18	6	3
08050RS5422Z03	○	50	54	47	75	22,0	10,4	6,3	20,0	18	11	24	8	3
08050RS5422Z04	○	50	54	47	75	22,0	10,4	6,3	20,0	18	11	32	8	4
08063RS6027Z05	○	63	60	60	80	27,0	12,4	7,0	22,0	20	14	45	9	5

Inserts are not included.

## Inserts

Application	Coated Carbide								RE	
	ACU2500	XCU2500	ACP100	ACP200	ACP300	XCK2000	ACK200	ACK300		ACM200
High Speed / Light Cutting	●	●	●	●	●	●	●	●	●	●
General Purpose Cutting	●	●	●	●	●	●	●	●	●	●
Rough Cutting	●	●	●	●	●	●	●	●	●	●
Cat. No.										
LNEX 080404 PNER-L	●	○	○	●	●	○	●	●	○	●
080408 PNER-L	●	○	○	●	●	○	●	●	○	●
080412 PNER-L	○	○	○	○	○	○	○	○	○	○
080416 PNER-L	○	○	○	○	○	○	○	○	○	○
LNEX 080404 PNER-G	●	○	○	●	●	○	●	●	○	●
080408 PNER-G	●	○	○	●	●	○	●	●	○	●
080412 PNER-G	○	○	○	○	○	○	○	○	○	○
080416 PNER-G	○	○	○	○	○	○	○	○	○	○

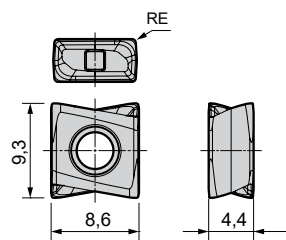

## Recommended Cutting Conditions

Min. - Optimum - Max.

ISO	Work-material	Hardness (HB)	Cutting Speed $v_c$ (m/min)	TSX 08000	TSX 13000	Grade
				Feed Rate $f_t$ (mm/T)	Feed Rate $f_t$ (mm/T)	
P	Carbon Steel	180-280	150-225-300	0,08-0,20-0,30	0,10-0,30-0,40	ACU2500 ACP100 ACP200 ACP300 XCU2500
		> 280	75-150-230	0,08-0,20-0,30	0,10-0,30-0,40	
M	Alloy Steel	180-280	100-175-250	0,08-0,15-0,25	0,10-0,25-0,35	ACU2500 ACM200 ACM300
		> 280	90-135-180	0,08-0,15-0,25	0,10-0,20-0,30	
K	Stainless Steel	220-280	90-135-180	0,08-0,15-0,25	0,10-0,20-0,30	ACU2500 ACK200 ACK300 XCU2500 XCK2000
		> 280	75-125-170	0,08-0,15-0,25	0,10-0,20-0,30	
S	Cast Iron Ductile Cast Iron	250	100-175-250	0,08-0,20-0,30	0,10-0,30-0,40	ACU2500 ACK200 ACK300 XCU2500 XCK2000
						ACU2500 ACM200 ACM300
S	Exotic Material	-	30-60-90	0,05-0,10-0,15	0,05-0,15-0,20	ACU2500 ACM200 ACM300

## Identification Details

**TSXR 08 050 R S 54 22 Z03**

Cutter Series	Insert Size	Cutter Diameter	Direction	Metric Type	Max. Depth of Cut	Bore Diameter	Effective Teeth
TSXR	08	050	R	S	54	22	Z03

## Spare Parts

Applicable Cutters	TRDR08IP	BFTX0308IP	2,0	Bolt
TSXR 08032RS3416Z02	TRDR08IP	BFTX0308IP	2,0	BX0845
TSXR 08040RS4016Z03				BX0850
TSXR 08050RS5422Z03				BX1060
TSXR 08050RS5422Z04				
TSXR 08063RS6027Z05				BX1265



# Repeater

# "Sumi Dual Mill" Series TSXR 13000 RS

## Shell Type

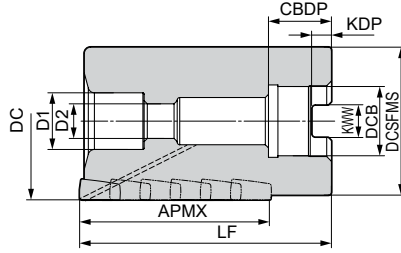

Rake Angle	Radial	-23° - -15°	41-60 mm	90°
	Axial	-6° - -3°		

## Body - TSXR

Cat. No.	Stock	Dimensions (mm)										No. of Teeth	Steps	Effective Teeth
		DC	APMX	DCSFMS	LF	DCB	KWW	KDP	CBDP	D1	D2			
TSXR 13040RS4116Z02	○	40	41	37	60	16,0	8,4	5,6	18,0	14	9	8	4	2
13050RS6022Z03	○	50	60	47	80	22,0	10,4	6,3	20,0	18	11	18	6	3
13063RS5027Z03	○	63	50	60	75	27,0	12,4	7,0	22,0	20	14	15	5	3
13063RS6027Z04	○	63	60	60	80	27,0	12,4	7,0	22,0	20	14	24	6	4
13080RS6032Z04	○	80	60	77	80	32,0	14,4	8,0	32,0	25	18	24	6	4
13080RS6032Z05	○	80	60	77	80	32,0	14,4	8,0	32,0	25	18	30	6	5
13100RS6040Z05	○	100	60	88	85	40,0	16,4	9,0	29,0	32	21	30	6	5
13100RS6040Z06	○	100	60	88	85	40,0	16,4	9,0	29,0	32	21	36	6	6
13125RS6040Z07	○	125	60	100	85	40,0	16,4	9,0	29,0	32	21	42	6	7

Inserts are not included.

## Inserts

Application	Coated Carbide								RE		
	ACU2500	XCU2500	ACP100	ACP200	ACP300	XCK2000	ACK200	ACK300		ACM200	ACM300
High Speed / Light Cutting	●	●	●	●	●	●	●	●	●	●	
General Purpose Cutting	●	●	●	●	●	●	●	●	●	●	
Rough Cutting	●	●	●	●	●	●	●	●	●	●	
Cat. No.	ACU2500	XCU2500	ACP100	ACP200	ACP300	XCK2000	ACK200	ACK300	ACM200	ACM300	RE
LNEX 130604 PNER-L	●			●	○		○	●	○	●	0,4
130608 PNER-L	○			●	○		○	●	○	●	0,8
130612 PNER-L	○			●	○			●	○	●	1,2
130616 PNER-L	○			○	○			○	○	○	1,6
130620 PNER-L	○			○	○			○	○	○	2,0
130624 PNER-L	○			○	○			○	○	○	2,4
130632 PNER-L	○			○	○			○	○	○	3,2
LNEX 130604 PNER-G	●	○	○	●	○	○	○	●	○	●	0,4
130608 PNER-G	●	○	○	●	○	○	○	●	○	●	0,8
130612 PNER-G	○			●	○			●	○	●	1,2
130616 PNER-G	○			○	○			○	○	○	1,6
130620 PNER-G	○			○	○			○	○	○	2,0
130624 PNER-G	○			○	○			○	○	○	2,4
130632 PNER-G	○			○	○			○	○	○	3,2
LNEX 130604 PNER-H	○			○	○		○	○			0,4
130608 PNER-H	○	○		●	○		○	●			0,8
130612 PNER-H	○			●	○			●			1,2
130616 PNER-H	○			○	○			○			1,6
130620 PNER-H	○			○	○			○			2,0
130624 PNER-H	○			○	○			○			2,4
130632 PNER-H	○			○	○			○			3,2

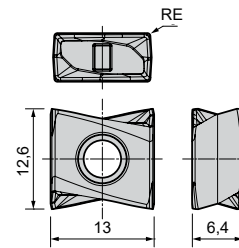

## Recommended Cutting Conditions

→ G38

## Identification Details

**TSXR 13 050 R S 60 22 Z03**

Cutter Series	Insert Size	Cutter Diameter	Direction	Metric Type	Max. Depth of Cut	Bore Diameter	Effective Teeth
TSXR	13	050	R	S	60	22	Z03

## Spare Parts

Applicable Cutters	Insert Wrench	Insert Screw	Bolt
	TSXR 13040RS4116Z02 TSXR 13050RS6022Z03 TSXR 13063RS5027Z03 TSXR 13063RS6027Z04 TSXR 13080RS6032Z04 TSXR 13080RS6032Z05 TSXR 13100RS6040Z05 TSXR 13100RS6040Z06 TSXR 13125RS6040Z07	TRDR15IP	BFTX03510IP

# "Wave Mill" Series

## WEZ Type

Expansion



### General Features

- Supports Various Machining Operations  
A lineup of cutter sizes from Ø 14 to Ø 160 mm, which enable large ramping angles, 28 repeater type items are now available in addition to the modular type and short shank type.
- Excellent Machining Quality  
With a combination of optimised cutting edge shape and high-precision molding technology, superb wall surface accuracy and surface finish quality are achieved.
- Excellent Sharpness with Low Resistance  
Reducing machining noise and suppressing burrs, the lineup includes ground type inserts with a focus on sharpness.
- Applicable to Various Work Materials  
In addition to the general-purpose grade ACU2500, the new generation coated carbide grades XCU2500/XCK2000 are available. Applicable to various work materials such as steel, stainless steel, cast iron, exotic alloys and more.

### Product Range WEZ (Standard)

Type	Cat. No.	Diameter Range (mm) / No of Teeth																
		Ø14	Ø16	Ø18	Ø20	Ø22	Ø25	Ø26	Ø28	Ø30	Ø32	Ø35	Ø40	Ø50	Ø63	Ø80	Ø100	Ø125
Shell	WEZ 11000RS											4, 6	5, 7	6, 8	7, 10	9, 12		
	WEZ 11000R (Inch)														7, 10	9, 12		
	WEZ 17000RS											3, 4	3, 5	4, 6	4, 7	5, 8	6, 9, 11	8, 10, 12
	WEZ 17000R (Inch)														4, 7	5, 8	6, 9, 11	8, 10, 12
Shank	WEZ 11000E	1	2*	2	2*, 3*	3	2, 3*, 4*		4	4	2, 3, 4, 5*	5	2, 4, 6	5, 7	8	10		
	WEZ 11000ES	1	2*		3*		4*											
	WEZ 11000EL	1	2*	2	2*	2	2*, 3		2	2	2*, 3	2, 3	2	3				
	WEZ 17000E						2*		2	3	2, 3*	3	3, 4	3*, 5*	4*, 6*	7		
	WEZ 17000ES						2				3							
	WEZ 17000EL						2		2	2	2*, 3	2	2, 3, 4	3*, 5*	4*, 6*			
Modu- lar	WEZ 11000M		2	2	2, 3	3	2, 3, 4	4, 5	4, 5	2, 4, 5	2, 3, 4, 5	2, 5	2, 4, 5, 6					
	WEZ 17000M						2, 3	2	2, 3	2, 3, 4	2, 3	2, 3, 4						

\* Different shank diameters in stock

### Product Range WEZR (Repeater)

Type	Cat. No.	Diameter Range (mm) / No of Teeth								
		Ø20	Ø25	Ø30	Ø32	Ø35	Ø40	Ø50	Ø63	Ø80
Shell	WEZR 11000RS						4	4		
	WEZR 17000RS							2, 3, 4	3, 4, 5	5
Shank	WEZR 11000E	1, 2	2	2	2, 3	3	3, 4			
	WEZR 17000E	→ H42-45					2, 3	2, 3		
Modu- lar	WEZR 11000M				3					
	WEZR 17000M	→ H50-53					3			

### Suitable Applications

- Supports Ramping, Helical Milling, Plunge Cutting

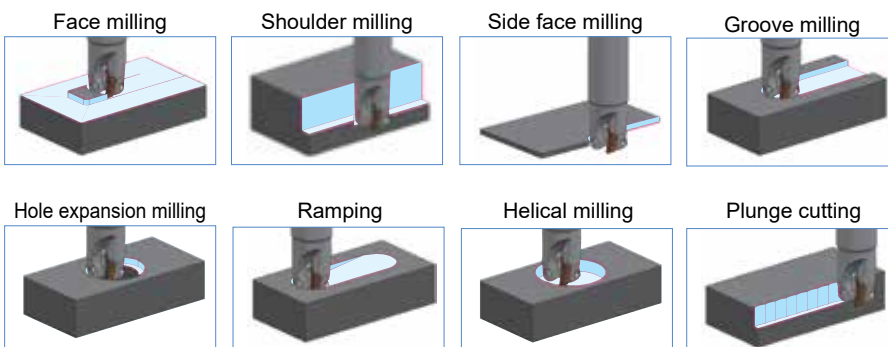

### Optimised Body Design

Wide guide face for stable insert clamping.



WEZ11 type

● = Euro stock

# "Wave Mill" Series WEZ Type

## Chipbreaker Lineup

Work Material	P		M	K	S	H	N
	L Type	G Type	H Type	F Type	P Type	S Type	
Chipbreaker							
AO_T11 Cutting edge geometry							
AO_T17 Cutting edge geometry							
Applications	Light cut, low rigidity machining	Main breaker for general purpose to interrupted machining	Heavy cut, heavy interrupted machining, hardened steel	Light cut, finishing, low-burr design	Light cut, high-precision machining, high surface wall quality		For non-ferrous metals

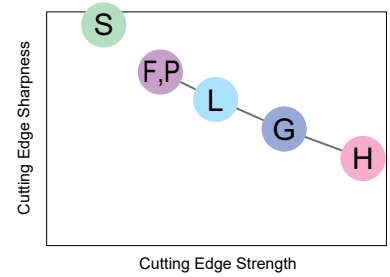

## Product Range Inserts

Main Grade: ACU2500; S-Type: H20, DL2000

Cat. No.	Nose Radius (mm)													
	R0,2	R0,4	R0,5	R0,8	R1,0	R1,2	R1,6	R2,0	R2,4	R3,0	R3,2	R4,0	R5,0	R6,4
AOMT 11T3 PEER-G	●	●	●	●	●	●	●	●	●	●	●			
AOMT 11T3 PEER-H		●	●	●	●	●	●	●	●	●	●			
AOET 11T3 PEER-F	●	●	●	●	●	●	●	●	●	●	●			
AOET 11T3 PEER-P16	●	●	●	●	●	●	●	●	●	●	●			
AOET 11T3 PEER-P20	●	●	●	●	●	●	●	●	●	●	●			
AOET 11T3 PEER-P25	●	●	●	●	●	●	●	●	●	●	●			
AOET 11T3 PEFR-S	●	●	●	●	●	●	●	●	●	●	●			
AOMT 1705 PEER-L	●	●	●	●	●	●	●	●	●	●	●			
AOMT 1705 PEER-G	●	●	●	●	●	●	●	●	●	●	●	●	●	●
AOMT 1705 PEER-H		●	●	●	●	●	●	●	●	●	●	●	●	●
AOET 1705 PEER-F	●	●	●	●	●	●	●	●	●	●	●	●	●	●
AOET 1705 PEER-P25	●	●	●	●	●	●	●	●	●	●	●	●	●	●
AOET 1705 PEER-P32	●	●	●	●	●	●	●	●	●	●	●	●	●	●
AOET 1705 PEFR-S	●	●	●	●	●	●	●	●	●	●	●	●	●	●

## Improved Milling Quality

### ● Excellent Squareness

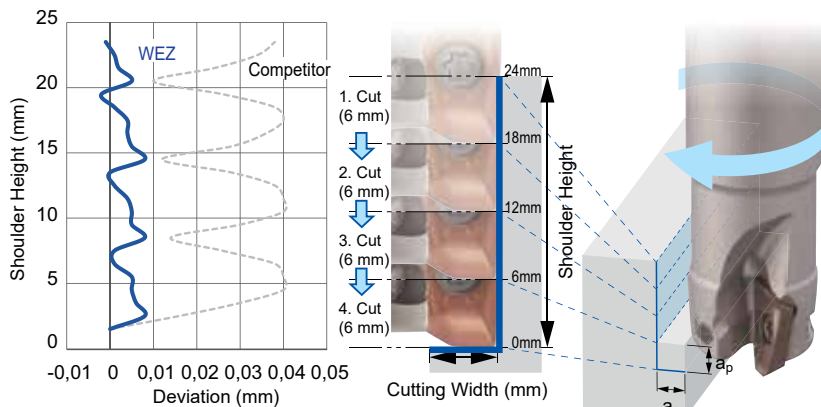

Machine: Vertical Machining Centre BT40,  
 Work Material: C50  
 Tool: WEZ 11020 E03 (Ø 20, 3 teeth)  
 Insert: AOMT11T308PEER-G (ACU2500)  
 Cutting Conditions:  $v_c = 150$  m/min,  $f_z = 0,15$  mm/t,  $a_p = 6$  mm x 4 passes,  $a_e = 5$  mm, dry

### ● Excellent Surface Quality

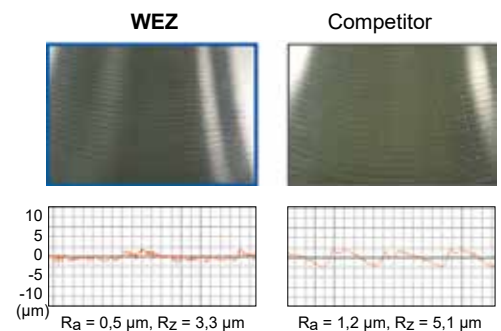

### ● Lower cutting force helps reduce machining noise

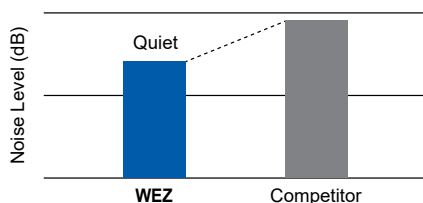

Machine: Vertical Machining Centre BT40,  
 Work Material: C50  
 Tool: WEZ 11020 E03 (Ø 20, 3 teeth)  
 Insert: AOMT11T308PEER-G (ACU2500)  
 Cutting Conditions:  $v_c = 150$  m/min,  $f_z = 0,15$  mm/t,  $a_p = 8$  mm,  $a_e = 5$  mm, dry



# "Wave Mill" Series WEZ Type



## ■ Features

- Developed for Multi-tasking Machines  
Short shank type ideal for low-rigidity multi-tasking machines
- Superb Machining Quality  
Shank design ideal for ER collets with face contact design that increases rigidity, realizing excellent shoulder accuracy and finished surface quality.
- A Wide Selection of Inserts  
Supports various machining applications with a wide selection of chipbreakers, with sharp cutting edges, different nose radii and dedicated grades for specific work materials.

## ■ Cutting Performance

### ● Excellent Squareness

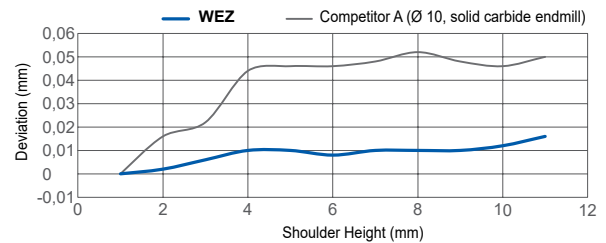
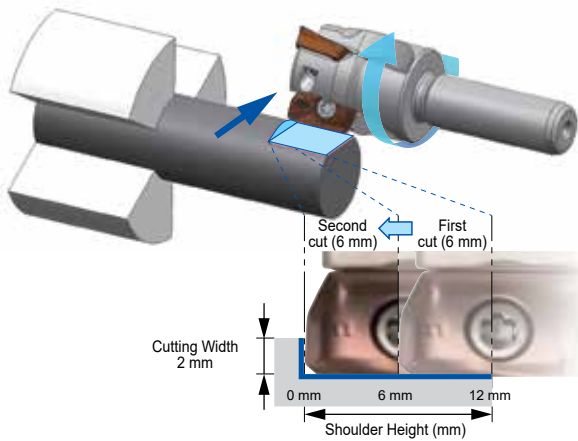

Machine: Composite NC lathe  
 Work Material: X5CrNiS1810, Ø 16 round bar  
 Tool: WEZ11020ES03-10 (Ø 20, 3 flutes)  
 Insert: AOET11T308PEER-F (ACU2500)  
 Cutting Data:  $v_c = 100$  m/min,  $f_z = 0,08$  mm/t  
 $a_p = 6$  mm x 2 passes,  $a_e = 2$  mm, wet

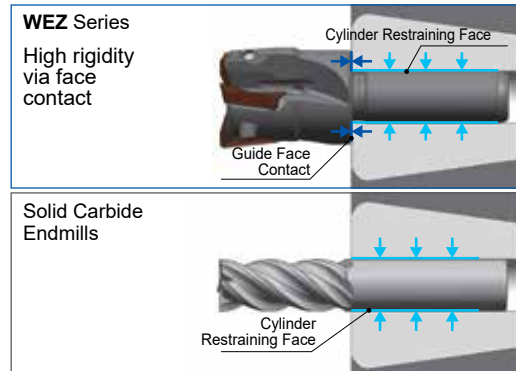

### ● Excellent Machined Surface Quality

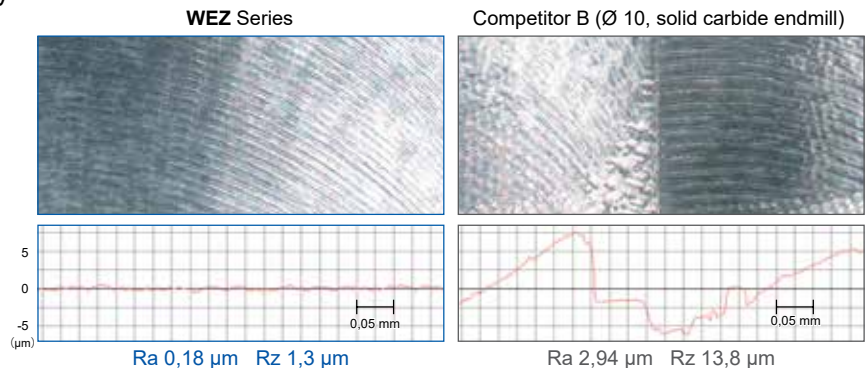
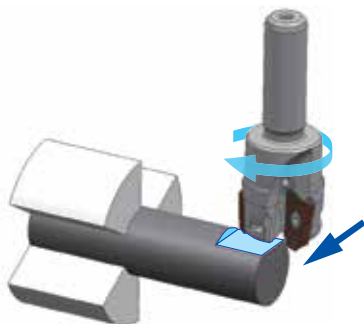

Machine: Composite NC lathe  
 Work Material: X5CrNiS1810, Ø 16 round bar  
 Tool: WEZ11020ES03-10 (Ø 20, 3 flutes)  
 Insert: AOET11T308PEER-F (ACU2500)  
 Cutting Data: **WEZ** type:  $v_c = 100$  m/min,  $f_z = 0,05$  mm/t,  $a_p = 2$  mm,  $a_e = 12$  mm, wet  
 Competitor:  $v_c = 100$  m/min,  $f_z = 0,05$  mm/t,  $a_p = 2$  mm,  $a_e = 6$  mm x 2 passes, wet (solid carbide endmill)

Larger tool diameter than carbide solid endmills enables reduced number of passes for high-efficiency machining.

Good shoulder accuracy and machined surface quality, eliminating the finishing process.

# "Wave Mill" Series WEZ Type

## Shoulder Milling Tool Selection Guide

### TSX Series – Accuracy

Ground insert



Surface finish

### WEZ Series – Sharpness

High rake wave cutting edge



Cutting force

Cutting edge strength



Shoulder accuracy

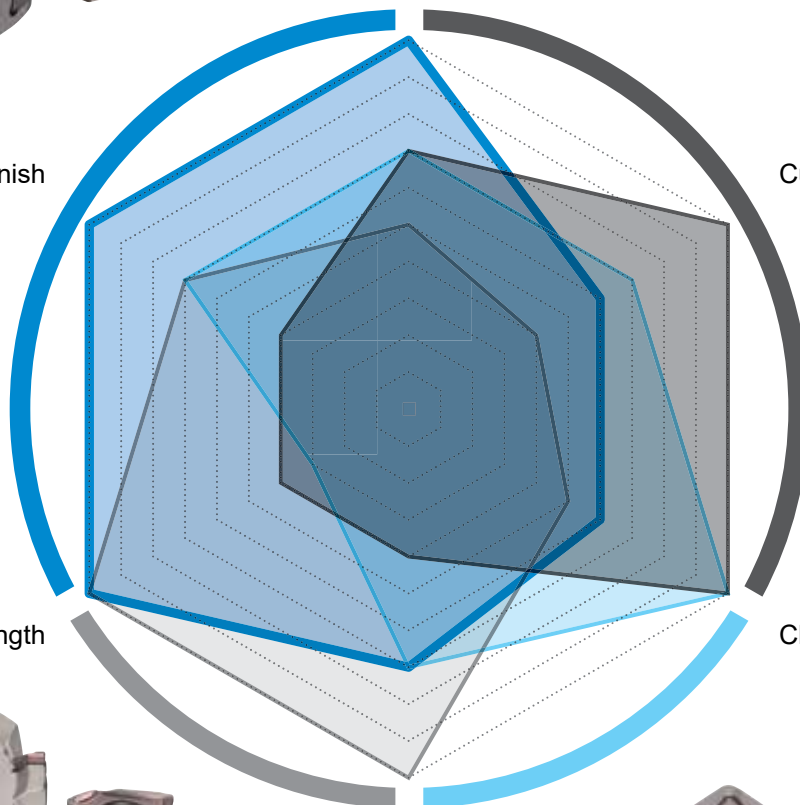

Chip control

Number of corners



### DFC Series – Economical

Six-cornered double side insert

### WFX Series – General Purpose

Four-cornered single side insert

★★★ Top recommendation

	Surface Finish	Shoulder Accuracy	Cutting Force	Chip Control	Number of Corners	Cutting edge Strength
<b>WEZ Series</b>	★★★	★★★	★★★	★★★	★	★☆
<b>TSX Series</b>	★★★	★★★	★★	★☆	★★	★★★
<b>DFC Series</b>	★☆	★	★	★☆	★★★	★★★
<b>WFX Series</b>	★☆	★★	★★	★★★	★★	★★

# "Wave Mill" Series

## WEZ Type

### High-precision Ground Class Insert with Excellent Sharpness

Ground Finish on Cutting Edge and Guide Face

The guide face has a ground finish as well as the cutting edge, minimizing corner difference when mounting on the body. Stable runout precision and machining quality.

Cutting edge flank

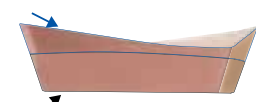

Guide face

### Lineup of Chipbreakers for Ground Inserts

#### F Type

Cutting edge specialized for sharpness and machining accuracy



Sharpness from ground finish enables burr control.

Excellent squareness with all diameters.

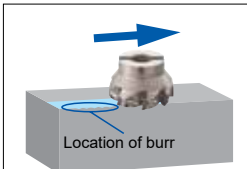

Location of burr

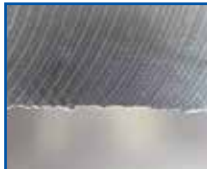

WEZ

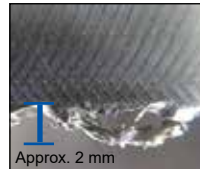

Competitor

Approx. 2 mm

Machine: Vertical Machining Centre BT50,  
Work Material: X5CrNiS18 9  
Tool: WEZ 11050 RS07 (Ø 50, 7 teeth)  
Insert: AOET11T308PEER-F (ACU2500)  
Cutting Conditions:  $v_c = 120$  m/min,  $f_z = 0,12$  mm/t,  $a_p = 1$  mm,  $a_e = 30$  mm, dry

#### P Type

Chipbreaker for wall surface squareness equivalent to solid endmills



Premium item with cutting edge shape optimised for each cutter diameter while maintaining the F type chipbreaker's sharpness.

Enables wall surface squareness equal to solid endmills through a blade shape optimised for each tool diameter.

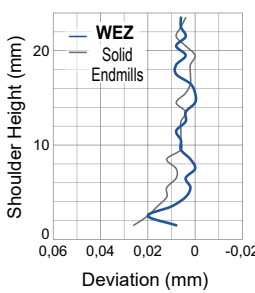

Shoulder Height (mm)

Deviation (mm)

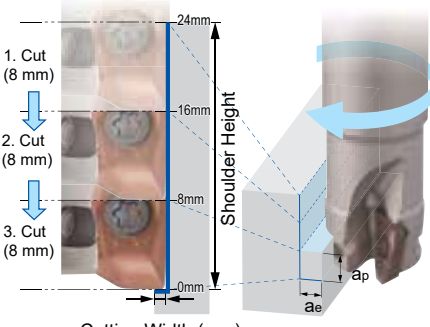

1. Cut (8 mm)  
2. Cut (8 mm)  
3. Cut (8 mm)

Shoulder Height

Cutting Width (mm)

Machine: Vertical Machining Centre BT50,  
Work Material: C50  
Tool: WEZ 11020 E03 (Ø 20, 3 teeth)  
Insert: AOET11T308PEER-P20 (ACU2500)  
Cutting Conditions:  $v_c = 150$  m/min,  $f_z = 0,1$  mm/t,  $a_p = 8$  mm x 3 passes,  $a_e = 1$  mm, dry

#### P Type Chipbreaker Selection

Cat. No.	Cutter Diameter (mm)										
	Ø14	Ø16	Ø18	Ø20	Ø22	Ø25	Ø28	Ø30	Ø32	Ø35	⇒ Ø40
AOET11T3__PEER-P__	-P16	-P20	-	-P25	-	-	-	-	-	-	-
AOET1705__PEER-P__	-	-	-	-	-	-P25	-	-	-P32	-	-

#### S Type

Sharp edge chipbreaker for non-ferrous metals, with excellent adhesion resistance



Suppresses adhesion with rake face lapping.

DLC coat inserts available for further improved adhesion resistance.



WEZ

No Adhesion



Competitor A

Adhesion



Competitor B

Adhesion

Machine: Vertical Machining Centre BT50,  
Work Material: AISi12Cu  
Tool: WEZ 11020 E03 (Ø 20, 3 teeth)  
Insert: AOET11T308PEER-S (H20)  
Cutting Conditions:  $v_c = 350$  m/min,  $f_z = 0,1$  mm/t,  $a_p = 3$  mm,  $a_e = 10$  mm, dry

## Insert Grades Selection Guide

New generation coated carbide grades **XCU2500**/**XCK2000** now available. Enhanced lineup of coatings in addition to cemented carbide and cermet for milling steel, stainless steel, cast iron and aluminum alloy.

ISO	Finishing – Light Cutting	Medium Cutting	Rough – Heavy Cutting
<b>P</b>	Coated Carbide	<b>ACU2500</b> <b>XCU2500</b> <b>New</b> ACP2000 ACP3000	
	Cermet	T2500A	
<b>M</b>	Coated Carbide	<b>ACU2500</b> <b>XCU2500</b> <b>New</b> ACM200 ACM300	
	Coated Carbide	<b>ACU2500</b> <b>XCU2500</b> <b>New</b> <b>XCK2000</b> <b>New</b> ACK2000 ACK3000	
<b>N</b>	Coated Carbide	DL2000	
	Carbide	H20	

▽: CVD ▲: PVD

## Coating Features

New Absotech™ (absolute technology) coating technology that realises absolute stability.

**ABSOTECH** CVD

Special Surface Treatment  
Suppresses thermal cracking by introducing high compressive stress, resulting in chipping resistance more than twice as good as conventional types

Crystal Orientation Control Al<sub>2</sub>O<sub>3</sub>  
By controlling the growth direction, Al<sub>2</sub>O<sub>3</sub> is reinforced for crater wear resistance more than twice as good as conventional types

High Hardness TiCN  
Increased TiCN hardness by using a C-rich composition for flank wear resistance more than twice as good as conventional types.

Grades: ACP2000, ACK2000

**ABSOTECH** PVD

New Super Multi-Layered Composition  
Higher hardness and twice the conventional wear resistance due to a fine crystal structure AlTiCrBN-based nano-layered coating.

High Adhesion Strength  
Significantly improved coating adhesion. Chipping resistance more than twice as good as conventional types.

Grades: ACU2500, ACP3000, ACK3000

**ABSOTECH** CVD

Pure cubic crystal AlTiN with high Al content  
With proprietary structural control technology, differently composed layers of AlTiN are stacked at the nanometre level.

With a high Al-composition containing over 80% Al on average, it also maintains a cubic crystalline structure to achieve excellent thermal resistance and high hardness. Vastly improved wear resistance.

Special Surface Treatment  
Proprietary surface treatment introduces high compression stress to the coating, suppressing the development of cracks.  
Greatly improved fracture and thermal crack resistance.

Grades: XCU2500, XCK2000

## Grade Characteristic Values

### CVD

ISO	Grade	Hardness (HRA)	TRS (GPa)	Coating Type	Coating Thickness (µm)	Features	Old Grade
<b>P</b>	ACP2000 <b>New</b>	89,5	3,2	ABSOTECH	10	<ul style="list-style-type: none"> <li>For high-speed machining of steel</li> <li>Stable long tool life in high-speed machining is realised by adopting a tough carbide substrate and a new coating with excellent thermal crack resistance</li> </ul>	ACP100
	XCU2500	89,5	3,2	ABSOTECH X	6	<ul style="list-style-type: none"> <li>General-purpose grade for a wide variety of materials such as steel, cast iron and stainless steel</li> <li>New coating combining wear and fracture resistance realises long tool life in medium-speed to high-speed machining</li> </ul>	—
<b>M</b>	ACM200	89,8	3,4	Super FF Coat	6	<ul style="list-style-type: none"> <li>For machining high-hardness stainless steel</li> <li>Adopts newly developed high-strength cemented carbide substrate with excellent wear resistance and thermal resistance, realizing outstanding stability when machining hardened stainless steel</li> </ul>	AC230
<b>K</b>	ACK2000 <b>New</b>	91,7	3,1	ABSOTECH	10	<ul style="list-style-type: none"> <li>For high-speed cast iron milling</li> <li>Stable long tool life in high-speed machining is realised by adopting a tough carbide substrate and a new coating with excellent thermal resistance</li> </ul>	ACK100 ACK200
	XCK2000	91,7	2,5	ABSOTECH X	6	<ul style="list-style-type: none"> <li>For high-speed cast iron milling</li> <li>Along with a high-hardness carbide substrate, the new coating combining wear and fracture resistance realises superb long tool life in medium-speed to high-speed machining</li> </ul>	—

### PVD

ISO	Grade	Hardness (HRA)	TRS (GPa)	Coating Type	Coating Thickness (µm)	Features	Old Grade
<b>P</b>	ACU2500	91,6	3,8	ABSOTECH	3	<ul style="list-style-type: none"> <li>General-purpose grade supporting steel, stainless steel, and cast iron machining</li> <li>Adopts a carbide substrate with excellent fracture resistance and wear resistance, plus a new coating with excellent wear resistance and chipping resistance, realising stable long tool life with various work material grades</li> </ul>	—
	ACP3000	89,5	3,2	ABSOTECH	3	<ul style="list-style-type: none"> <li>Our 1st recommended grade for milling steel</li> <li>Carbide substrate with excellent thermal crack resistance, plus a new coating with excellent wear resistance and chipping resistance, realises stable long tool life over a wide range of cutting conditions</li> </ul>	ACP200 ACP300
<b>M</b>	ACM300	89,8	3,4	(New) Super ZX Coat	3	<ul style="list-style-type: none"> <li>Our 1st recommended grade for milling stainless steel</li> <li>Adopts high-strength cemented carbide substrate and super multi-layered coating for next-level wear resistance and fracture resistance</li> </ul>	—
<b>K</b>	ACK3000	91,7	3,1	ABSOTECH	3	<ul style="list-style-type: none"> <li>Our 1st recommended grade for milling cast iron</li> <li>Adopts a high thermal conductivity carbide substrate and a new coating with excellent wear resistance and chipping resistance, realizing stable long tool life over a wide range of cast iron machining operations</li> </ul>	ACK300
<b>N</b>	DL2000	91,6	3,8	AURORA Coat (DLC)	0,5	<ul style="list-style-type: none"> <li>Grade for milling non-ferrous metal, utilising DLC coat with a low coefficient of friction and excellent adhesion resistance</li> </ul>	—

### Cermet

ISO	Grade	Hardness (HRA)	TRS (GPa)	Coating Type	Coating Thickness (µm)	Features	Old Grade
<b>P</b> <b>M</b>	T2500A	91,8	2,4	—	—	<ul style="list-style-type: none"> <li>For finishing of steel and stainless steel</li> <li>Fine, uniform grain structure greatly improves toughness, realising long tool life and excellent surface finishes</li> </ul>	T2500A

# "Wave Mill" Series

## WEZ Type



### Recommended Cutting Conditions

#### WEZ11 Type

Cutter: WEZ 11020 E03  
 Insert: AO\_T11T3 type  
 Cutting Data:  $a_p = 3 \text{ mm}$ ,  $a_e = 10 \text{ mm}$ , dry

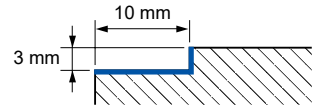

Min. - Optimum - Max.

ISO	Material	HB	Chipbreaker	Grade										
				ACU2500	XCU2500	ACP2000	ACP3000	T2500A	XCK2000	ACK2000	ACK3000	ACM200	ACM300	DL2000
				Feed Rate (mm/tooth)										
				0,08-0,15-0,20	0,08-0,15-0,20	0,08-0,15-0,20	0,08-0,15-0,20	0,08-0,15-0,18	0,08-0,15-0,20	0,08-0,15-0,20	0,08-0,15-0,20	0,08-0,15-0,20	0,08-0,15-0,20	0,05-0,10-0,15
				Cutting Speed $v_c$ (m/min)										
P	Unalloyed steel, <0,15%C, annealed	125	G	270-320-370	300-350-400	300-350-400	250-300-350	230-280-330						
	·, <0,45%C, annealed	190	G	170-220-270	200-250-300	200-250-300	150-200-250	130-180-230						
	·, <0,45%C, tempered	250	G	140-180-220	160-200-245	160-200-245	120-160-200	105-145-185						
	·, <0,75%C, annealed	270	G	110-145-175	130-165-195	130-165-195	100-130-165	85-115-150						
	·, <0,75%C, tempered	300	G	70-90-110	80-100-120	80-100-120	60-80-100	50-70-90						
	Low alloyed steel, annealed	180	G	160-205-255	190-235-280	190-235-280	140-190-235	120-170-215						
	·, tempered	275	G	90-120-150	110-135-165	110-135-165	80-110-140	70-100-125						
	·, tempered	300	G	85-110-130	100-125-150	100-125-150	75-100-125	65-90-115						
·, tempered	350	G	60-80-100	70-90-110	70-90-110	50-70-90	45-65-85							
M	High alloyed and tool steel, annealed	200	G	140-180-220	160-200-245	160-200-245	120-160-205							
	·, tempered	325	G	55-70-85	60-80-100	60-80-100	50-65-80							
	Stainless steel, ferritic/martensitic, annealed	200	G	110-140-170	160-190-210					140-170-190	90-110-140			
·, martensitic, tempered	240	G	100-125-150	145-170-190					125-150-170	80-100-125				
·, austenitic, plunged	180	G	120-150-180	170-200-220					150-180-200	100-120-150				
K	Grey cast iron		G	150-200-250	250-300-350			250-300-350	250-300-350	170-220-270				
	Nodular cast iron		G	90-120-150	150-180-210			150-180-210	150-180-210	100-130-160				
S	High tempered resist. alloys, Fe based, annealed		G	30-40-55							35-45-60	25-35-50		
	·, hardened		G	60-80-100							70-90-110	50-70-90		
N	Aluminium alloy, Si < 12,6%		S											500-750-1000
	·, Si > 12,6%		S											170-200-250
	Copper alloy		S											300-330-350

The above recommended cutting conditions are meant as a guide. Actual conditions will depend on the individual machine, work shape and clamping. They will need to be adjusted according to machine rigidity, work clamp rigidity, cutting depth and other factors.

For groove milling, reduce the feed rate approximately 70 % of the corresponding value shown above.

#### WEZ17 Type

Cutter: WEZ 17032 E03  
 Insert: AO\_T1705 type  
 Cutting Data:  $a_p = 5 \text{ mm}$ ,  $a_e = 16 \text{ mm}$ , dry

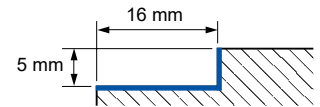

Min. - Optimum - Max.

ISO	Material	HB	Chipbreaker	Grade										
				ACU2500	XCU2500	ACP2000	ACP3000	T2500A	XCK2000	ACK2000	ACK3000	ACM200	ACM300	DL2000
				Feed Rate (mm/tooth)										
				0,10-0,20-0,28	0,10-0,20-0,28	0,10-0,20-0,28	0,10-0,20-0,28	0,10-0,15-0,22	0,10-0,20-0,28	0,10-0,20-0,28	0,10-0,20-0,28	0,10-0,20-0,28	0,10-0,20-0,28	0,05-0,10-0,15
				Cutting Speed $v_c$ (m/min)										
P	Unalloyed steel, <0,15%C, annealed	125	G	285-335-390	315-360-420	315-360-420	265-315-370	240-295-345						
	·, <0,45%C, annealed	190	G	180-230-285	210-265-315	210-265-315	160-210-265	135-190-240						
	·, <0,45%C, tempered	250	G	145-190-230	170-210-255	170-210-255	130-170-215	110-155-195						
	·, <0,75%C, annealed	270	G	115-150-185	135-170-205	135-170-205	100-135-170	90-125-155						
	·, <0,75%C, tempered	300	G	70-90-115	85-105-125	85-105-125	65-85-105	55-75-95						
	Low alloyed steel, annealed	180	G	170-220-265	200-245-295	200-245-295	150-200-250	130-180-225						
	·, tempered	275	G	100-130-155	115-145-175	115-145-175	85-115-145	75-105-135						
	·, tempered	300	G	90-115-140	105-130-155	105-130-155	75-105-130	65-90-120						
·, tempered	350	G	65-85-100	75-95-115	75-95-115	55-75-95	50-70-85							
M	High alloyed and tool steel, annealed	200	G	145-185-230	170-215-255	170-215-255	130-170-215							
	·, tempered	325	G	55-75-90	65-85-100	65-85-100	50-65-85							
	Stainless steel, ferritic/martensitic, annealed	200	G	115-145-175	165-195-215					145-175-195	100-115-145			
·, martensitic, tempered	240	G	105-130-155	150-175-195					130-155-175	85-105-130				
·, austenitic, plunged	180	G	125-155-190	180-210-230					160-190-210	105-125-160				
K	Grey cast iron		G	160-210-265	265-315-370			265-315-370	265-315-370	180-230-285				
	Nodular cast iron		G	95-125-160	160-190-220			160-190-220	160-190-220	105-140-170				
S	High tempered resist. alloys, Fe based, annealed		G	30-40-60							35-45-60	25-35-50		
	·, hardened		G	60-85-105							75-95-115	50-75-95		
N	Aluminium alloy, Si < 12,6%		S											500-750-1000
	·, Si > 12,6%		S											170-200-250
	Copper alloy		S											300-330-350

The above recommended cutting conditions are meant as a guide. Actual conditions will depend on the individual machine, work shape and clamping. They will need to be adjusted according to machine rigidity, work clamp rigidity, cutting depth and other factors.

For groove milling, reduce the feed rate approximately 70 % of the corresponding value shown above.



## ■ Ramping / Helical Milling Upper Limits

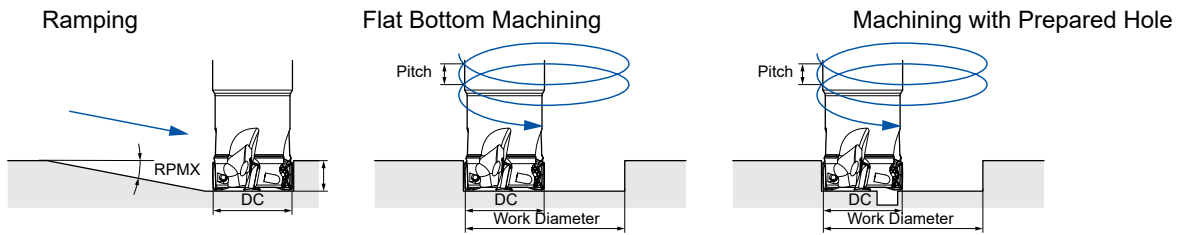

### ● WEZ11 Type

DC Ø (mm)	Max.Ramping Angle	Flat Bottom Machining				Machining with Prepared Hole	
	RPMX (°)	Max. Machining Diam. (mm)	Max. Pitch (mm/rev)	Min. Machining Diam. (mm)	Max. Pitch (mm/rev)	Min. Machining Diam. (mm)	Max. Pitch (mm/rev)
14	13,2	25,3	8,4	23,1	5,9	19,0	1,9
16	10,5	29,3	7,6	27,0	5,6	21,7	1,5
18	8,1	33,3	6,7	30,9	5,0	25,2	1,4
20	6,5	37,3	6,0	34,9	4,6	29,1	1,3
22	5,3	41,3	5,4	38,8	4,3	32,9	1,3
25	4,1	47,3	4,8	44,8	3,9	38,9	1,3
28	3,4	53,3	4,4	50,7	3,6	44,9	1,3
30	3,0	57,3	4,2	54,7	3,5	48,8	1,3
32	2,7	61,3	4,0	58,7	3,3	52,8	1,2
35	2,3	67,3	3,8	64,6	3,1	58,8	1,2
40	1,8	77,3	3,4	74,6	2,9	68,8	1,2
50	1,2	97,3	3,0	94,6	2,6	88,8	1,1
63	0,8	123,3	2,8	120,5	2,5	114,7	1,1

### ● WEZ17 Type

DC Ø (mm)	Max.Ramping Angle	Flat Bottom Machining				Machining with Prepared Hole	
	RPMX (°)	Max. Machining Diam. (mm)	Max. Pitch (mm/rev)	Min. Machining Diam. (mm)	Max. Pitch (mm/rev)	Min. Machining Diam. (mm)	Max. Pitch (mm/rev)
25	10,8	47,3	13,0	41,0	8,3	33,1	1,8
28	8,1	53,3	11,1	46,9	7,5	39,0	1,8
30	7,0	57,3	10,2	50,9	7,0	43,0	1,8
32	6,1	61,3	9,5	54,9	6,7	47,0	1,7
35	5,1	67,3	8,7	60,8	6,2	53,0	1,7
40	4,0	77,3	7,7	70,8	5,7	63,0	1,7
50	2,5	97,3	6,5	90,7	5,0	83,0	1,6
63	1,8	123,3	5,6	116,7	4,5	109,0	1,6

\* The table above shows values with nose radius 0,8 mm

## ■ Plunge Cutting - Upper Limit for Radial Width $a_e$

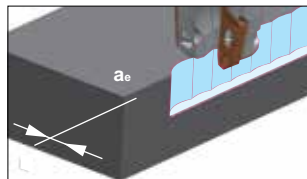

Type	Max. $a_e$ (mm)
WEZ11	3
WEZ17	5

## ■ Precautions for Mounting

- (1) Clean the mounting seat and contact parts.
- (2) Apply screw lubrication to the screw thread as well as the screw head face to prevent seizure.
- (3) While pressing the insert solidly against the seat surface, tighten at the screws with the included wrench.
- (4) After tightening, check that there are no gaps between the surfaces.





# "Wave Mill" Series WEZ 11000 R(S)

Rake Angle	Radial	-7° - -11°	10 mm	90°
	Axial	14° - 15°		

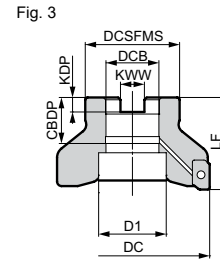
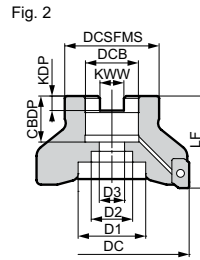
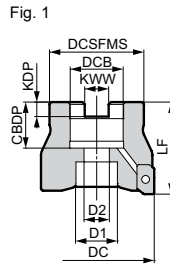

## ■ Body - WEZ (Shell Type)

Dimensions (mm)

Cat. No.	Stock	DC	DCSFMS	LF	DCB	KWW	KDP	CDBP	D1	D2	D3	No. of Teeth	Weight (kg)	Fig.
Metric														
WEZ 11040RS04	●	40	33	40	16	8,4	5,6	18	14	9	-	4	0,21	1
11040RS06	●	40	33	40	16	8,4	5,6	18	14	9	-	6	0,20	1
11050RS05	●	50	41	40	22	10,4	6,3	20	18	11	-	5	0,32	1
11050RS07	●	50	41	40	22	10,4	6,3	20	18	11	-	7	0,31	1
11063RS06	●	63	50	40	22	10,4	6,3	20	18	11	-	6	0,58	1
11063RS08	●	63	50	40	22	10,4	6,3	20	18	11	-	8	0,57	1
11080RS07	●	*80	55	50	27	12,4	7,0	22	20	14	-	7	1,08	1
11080RS10	●	*80	55	50	27	12,4	7,0	22	20	14	-	10	1,07	1
11100RS09	●	100	70	50	32	14,4	8,0	32	46	-	-	9	1,57	3
11100RS12	●	100	70	50	32	14,4	8,0	32	46	-	-	12	1,56	3
Inch														
WEZ 11080R07	○	*80	55	50	25,4	9,5	6,0	25	20	14	-	7	1,09	1
11080R10	○	*80	55	50	25,4	9,5	6,0	25	20	14	-	10	1,08	1
11100R09	○	*100	70	63	31,75	12,7	8,0	32	46	27	18	9	2,12	2
11100R12	○	*100	70	63	31,75	12,7	8,0	32	46	27	18	12	2,10	2

Inserts are sold separately. Check the arbor mounting size (DCB) when selecting the cutter.

\* For securing the Ø 80 mm and Ø 100 mm cutter to the arbors, use JIS B1176 hexagonal bolt.  
(Ø 80 mm: M12x30 to 35 mm, Ø 100 mm: M16x40x45 mm)



## ■ Spare Parts

Applicable Cutters	Insert Screw		Wrench
WEZ 11040RS04 11040RS06 11050RS05 11050RS07 11063RS06 11063RS08 11080R(S)07 11080R(S)10 11100R(S)09 11100R(S)12	BFTX0306IP	1,5	TRDR08IP

## ■ Recommended Cutting Conditions

→ G46

## ■ Identification Details

<b>WEZ</b>	<b>11</b>	<b>050</b>	<b>R</b>	<b>S</b>	<b>07</b>
Cutter Series	Insert Size	Cutter Diameter	Feed Direction	Metric	Number of Teeth

\*When mounting inserts with nose radius of  $\geq 2,4$  mm, modification of the body is required.



Modify this edge.

Reworking guidelines

Corner radius = 2,4 mm: C = 1 mm (AOMT11T324PEER)

Corner radius = 3,0 mm: C = 1 mm (AOMT11T330PEER)

Corner radius = 3,2 mm: C = 1 mm (AOMT11T332PEER)

Standard: R = 1 mm

Standard: R = 1 mm

Standard: R = 1 mm

Standard: R = 1 mm

C: Chamfer

R: Radius

## Inserts

Precautions for Mounting → G47

Dimensions (mm)

Application	Coated Carbide								Carbide	DLC	Cermets	RE	Fig.	
	P	K	P	K	K	M	S	M						
High Speed / Light Cut														
General Purpose														
Roughing														
Cat. No.	ACU2500	XCU2500	ACP2000	ACP3000	XCK2000	ACK2000	ACK3000	ACM200	ACM300	H20	DL2000	T2500A	RE	Fig.
AOMT 11T302PEER-G	●	○	□	●	○	□	●	●	●	-	-	●	0,2	1
11T304PEER-G	●	○	□	●	○	□	●	●	●	-	-	●	0,4	1
11T305PEER-G	●	○	□	●	○	□	●	●	●	-	-	●	0,5	1
11T308PEER-G	●	○	□	●	○	□	●	●	●	-	-	●	0,8	1
11T310PEER-G	●	○	□	●	○	□	●	●	●	-	-	□	1,0	1
11T312PEER-G	●	○	□	●	○	□	●	●	●	-	-	□	1,2	1
11T316PEER-G	●	○	□	●	○	□	●	●	●	-	-	□	1,6	1
11T320PEER-G	●	○	□	●	○	□	●	●	●	-	-	□	2,0	1
11T324PEER-G	●	○	□	●	○	□	●	●	●	-	-	□	2,4	1
11T330PEER-G	●	○	□	●	○	□	●	●	●	-	-	□	3,0	2
11T332PEER-G	●	○	□	●	○	□	●	●	●	-	-	□	3,2	2
AOMT 11T304PEER-H	●	○	□	●	○	□	●	●	●	-	-	-	0,4	1
11T308PEER-H	●	○	□	●	○	□	●	●	●	-	-	-	0,8	1
11T312PEER-H	●	○	□	●	○	□	●	●	●	-	-	-	1,2	1
11T316PEER-H	●	○	□	●	○	□	●	●	●	-	-	-	1,6	1
AOET 11T302PEER-F	●	-	-	-	-	-	-	-	-	-	-	-	0,2	1
11T304PEER-F	●	-	-	-	-	-	-	-	-	-	-	-	0,4	1
11T305PEER-F	●	-	-	-	-	-	-	-	-	-	-	-	0,5	1
11T308PEER-F	●	-	-	-	-	-	-	-	-	-	-	-	0,8	1
11T310PEER-F	●	-	-	-	-	-	-	-	-	-	-	-	1,0	1
11T312PEER-F	●	-	-	-	-	-	-	-	-	-	-	-	1,2	1
11T316PEER-F	●	-	-	-	-	-	-	-	-	-	-	-	1,6	1
11T320PEER-F	●	-	-	-	-	-	-	-	-	-	-	-	2,0	1
11T324PEER-F	●	-	-	-	-	-	-	-	-	-	-	-	2,4	1
11T330PEER-F	●	-	-	-	-	-	-	-	-	-	-	-	3,0	2
11T332PEER-F	●	-	-	-	-	-	-	-	-	-	-	-	3,2	2
AOET 11T302PEFR-S	-	-	-	-	-	-	-	-	●	●	-	-	0,2	1
11T304PEFR-S	-	-	-	-	-	-	-	-	●	●	-	-	0,4	1
11T305PEFR-S	-	-	-	-	-	-	-	-	●	●	-	-	0,5	1
11T308PEFR-S	-	-	-	-	-	-	-	-	●	●	-	-	0,8	1
11T310PEFR-S	-	-	-	-	-	-	-	-	●	●	-	-	1,0	1
11T312PEFR-S	-	-	-	-	-	-	-	-	●	●	-	-	1,2	1
11T316PEFR-S	-	-	-	-	-	-	-	-	●	●	-	-	1,6	1
11T320PEFR-S	-	-	-	-	-	-	-	-	●	●	-	-	2,0	1
11T324PEFR-S	-	-	-	-	-	-	-	-	●	●	-	-	2,4	1
11T330PEFR-S	-	-	-	-	-	-	-	-	●	●	-	-	3,0	2
11T332PEFR-S	-	-	-	-	-	-	-	-	●	●	-	-	3,2	2

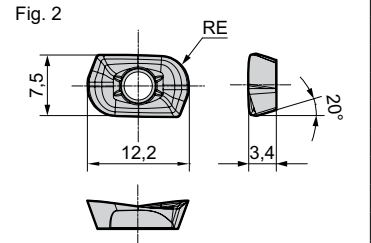
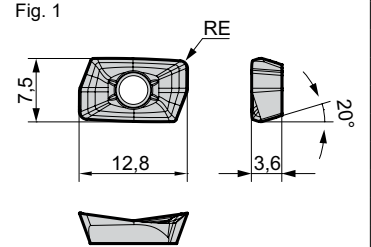

L: Low cutting force  
 G: General purpose  
 H: Strong edge  
 F: Finishing  
 P: High-precision machining  
 S: Non ferrous metals

# "Wave Mill" Series WEZ 17000 R(S)

Rake Angle	Radial	-4° - -9°	15 mm	90°
	Axial	10° - 15°		

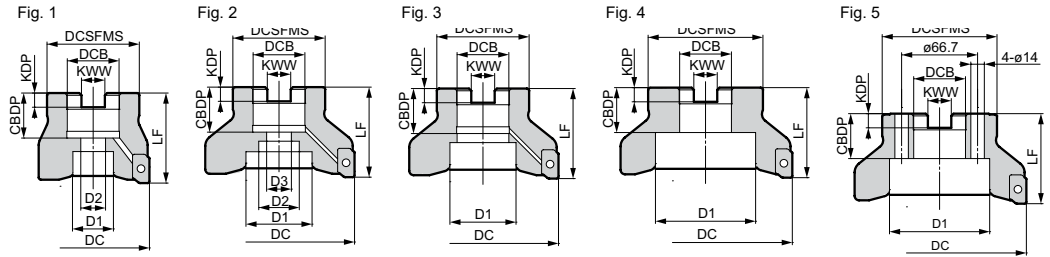

## ■ Body - WEZ (Shell Type)

Dimensions (mm)

	Cat. No.	Stock	DC	DCSFMS	LF	DCB	KWW	KDP	CBDP	D1	D2	D3	No. of Teeth	Weight (kg)	Fig.
Metric	WEZ 17040RS03	●	40	33	40	16	8,4	5,6	18	14	9	-	3	0,19	1
	17040RS04	●	40	33	40	16	8,4	5,6	18	14	9	-	4	0,16	1
	17050RS03	●	50	41	40	22	10,4	6,3	20	18	11	-	3	0,30	1
	17050RS05	●	50	41	40	22	10,4	6,3	20	18	11	-	5	0,26	1
	17063RS04	●	63	50	40	22	10,4	6,3	20	18	11	-	4	0,54	1
	17063RS06	●	63	50	40	22	10,4	6,3	20	18	11	-	6	0,51	1
	17080RS04	●	*80	55	50	27	12,4	7,0	22	20	14	-	4	1,10	1
	17080RS07	●	*80	55	50	27	12,4	7,0	22	20	14	-	7	1,05	1
	17100RS05	●	100	70	50	32	14,4	8,0	32	32	46	-	5	1,58	3
	17100RS08	●	100	70	50	32	14,4	8,0	32	32	46	-	8	1,57	3
	17125RS06	●	125	80	63	40	16,4	9,0	29	52	29	-	6	3,04	1
	17125RS09	●	125	80	63	40	16,4	9,0	29	52	29	-	9	3,07	1
17125RS11	●	125	80	63	40	16,4	9,0	29	52	29	-	11	3,02	1	
17160RS08	●	160	130	63	40	16,4	9,0	29	90	-	-	8	5,24	5	
17160RS10	●	160	130	63	40	16,4	9,0	29	90	-	-	10	5,31	5	
17160RS12	●	160	130	63	40	16,4	9,0	29	90	-	-	12	5,26	5	
Inch	WEZ 17080R04	○	*80	55	50	25,4	9,5	6,0	25	20	14	-	4	1,10	1
	17080R07	○	*80	55	50	25,4	9,5	6,0	25	20	14	-	7	1,06	1
	17100R05	○	*100	70	63	31,75	12,7	8,0	32	46	27	18	5	2,08	2
	17100R08	○	*100	70	63	31,75	12,7	8,0	32	46	27	18	8	2,07	2
	17125R06	○	125	80	63	38,1	15,9	10,0	35,5	55	30	-	6	3,09	1
	17125R09	○	125	80	63	38,1	15,9	10,0	35,5	55	30	-	9	3,11	1
	17125R11	○	125	80	63	38,1	15,9	10,0	35,5	55	30	-	11	3,06	1
	17160R08	○	160	100	63	50,8	19,1	11,0	38	72	-	-	8	5,04	4
	17160R10	○	160	100	63	50,8	19,1	11,0	38	72	-	-	10	5,09	4
	17160R12	○	160	100	63	50,8	19,1	11,0	38	72	-	-	12	5,04	4

Inserts are sold separately. Check the arbor mounting size (DCB) when selecting the cutter.

\* For securing the Ø 80 mm and Ø 100 mm cutter to the arbors, use JIS B1176 hexagonal bolt.  
(Ø 80 mm: M12x30 to 35 mm, Ø 100 mm: M16x40x45 mm)

## ■ Spare Parts

Applicable Cutters	Insert Screw		Wrench	Handle Grip	Wrench Bit
	WEZ 17040RS03 17040RS04 17050RS03 17050RS05 17063RS04 17063RS06 17080R(S)04 17080R(S)07 17100R(S)05 17100R(S)08 17125R(S)06 17125R(S)09 17125R(S)11 17160R(S)08 17160R(S)10 17160R(S)12	BFTX0409IP	3,0	-	HPS1015
			TRDR15IP	-	-

## ■ Recommended Cutting Conditions

→ G46

## ■ Identification Details

<b>WEZ</b>	<b>17</b>	<b>100</b>	<b>R</b>	<b>S</b>	<b>05</b>
Cutter Series	Insert Size	Cutter Diameter	Feed Direction	Metric	Number of Teeth

\*When mounting inserts with nose radius of  $\geq 2,4$  mm, modification of the body is required.

Modify this edge.

Reworking guidelines  
 Corner radius = 2,4 mm: C = 1 mm (AOMT170524PEER)  
 Corner radius = 3,0 mm: C = 1 mm (AOMT170530PEER)  
 Corner radius = 3,2 mm: C = 1 mm (AOMT170532PEER)  
 Corner radius = 4,0 mm: C = 2 mm (AOMT170540PEER)  
 Corner radius = 5,0 mm: C = 5 mm (AOMT170550PEER)  
 Corner radius = 6,4 mm: C = 5 mm (AOMT170564PEER)  
 Standard: R = 1 mm

C: Chamfer  
R: Radius

## Inserts

## Precautions for Mounting

→ G47

Dimensions (mm)

Application	Coated Carbide								Carbide	DLC	Cermets	RE	Fig.	
	K	M	P	P	K	K	M	S						
High Speed / Light Cut											N	P		
General Purpose											N	N		
Roughing											N	N		
Cat. No.	ACU2500	XCU2500	ACP2000	ACP3000	XCK2000	ACK2000	ACK3000	ACM200	ACM300	H20	DL2000	T2500A		
AOMT 170502PEER-L	●			□			□	●	●			□	0,2	1
170504PEER-L	●	○	-	●	○	-	□	●	●	-	-	●	0,4	1
170508PEER-L	●	○	-	●	○	-	□	●	●	-	-	●	0,8	1
170512PEER-L	●		-	□		-	□	●	●	-	-		1,2	1
170516PEER-L	●		-	□		-	□	●	●	-	-		1,6	1
AOMT 170502PEER-G	●		□	●		□	●	●	●	-	-	□	0,2	1
170504PEER-G	●	○	□	●	○	●	□	●	●	-	-	●	0,4	1
170505PEER-G	●		□	□		□	□	●	●	-	-	□	0,5	1
170508PEER-G	●	○	●	●	○	●	●	●	●	-	-	●	0,8	1
170510PEER-G	●		□	□		□	□	●	●	-	-	□	1,0	1
170512PEER-G	●		□	●		□	●	●	●	-	-	□	1,2	1
170516PEER-G	●		□	●		□	●	●	●	-	-		1,6	1
170520PEER-G	●		□	●		□	●	●	●	-	-		2,0	1
170524PEER-G	●		□	□		□	□	●	●	-	-		2,4	1
170530PEER-G	●		□	●		□	●	●	●	-	-		3,0	1
170532PEER-G	●		□	□		□	□	●	●	-	-		3,2	1
170540PEER-G	●		□	●		□	●	●	●	-	-		4,0	1
170550PEER-G	●		□	●		□	●	●	●	-	-		5,0	2
170564PEER-G	●		□	□		□	□	●	●	-	-		6,4	2
AOMT 170504PEER-H	●	○	●	●	○	●	●	●	●	-	-	-	0,4	1
170508PEER-H	●	○	●	●	○	●	●	●	●	-	-	-	0,8	1
170512PEER-H	●		□	□		□	□	●	●	-	-	-	1,2	1
170516PEER-H	●		□	●		□	□	●	●	-	-	-	1,6	1
AOET 170502PEER-F	●		-			-	-	-	-	-	-	-	0,2	1
170504PEER-F	●		-			-	-	-	-	-	-	-	0,4	1
170505PEER-F	●		-			-	-	-	-	-	-	-	0,5	1
170508PEER-F	●		-			-	-	-	-	-	-	-	0,8	1
170510PEER-F	●		-			-	-	-	-	-	-	-	1,0	1
170512PEER-F	●		-			-	-	-	-	-	-	-	1,2	1
170516PEER-F	●		-			-	-	-	-	-	-	-	1,6	1
170520PEER-F	●		-			-	-	-	-	-	-	-	2,0	1
170524PEER-F	●		-			-	-	-	-	-	-	-	2,4	1
170530PEER-F	●		-			-	-	-	-	-	-	-	3,0	1
170532PEER-F	●		-			-	-	-	-	-	-	-	3,2	1
170540PEER-F	●		-			-	-	-	-	-	-	-	4,0	1
170550PEER-F	●		-			-	-	-	-	-	-	-	5,0	2
170564PEER-F	●		-			-	-	-	-	-	-	-	6,4	2
AOET 170502PEFR-S	-	-	-	-	-	-	-	-	●	●	-	-	0,2	1
170504PEFR-S	-	-	-	-	-	-	-	-	●	●	-	-	0,4	1
170505PEFR-S	-	-	-	-	-	-	-	-	●	●	-	-	0,5	1
170508PEFR-S	-	-	-	-	-	-	-	-	●	●	-	-	0,8	1
170510PEFR-S	-	-	-	-	-	-	-	-	●	●	-	-	1,0	1
170512PEFR-S	-	-	-	-	-	-	-	-	●	●	-	-	1,2	1
170516PEFR-S	-	-	-	-	-	-	-	-	●	●	-	-	1,6	1
170520PEFR-S	-	-	-	-	-	-	-	-	●	●	-	-	2,0	1
170524PEFR-S	-	-	-	-	-	-	-	-	●	●	-	-	2,4	1
170530PEFR-S	-	-	-	-	-	-	-	-	●	●	-	-	3,0	1
170532PEFR-S	-	-	-	-	-	-	-	-	●	●	-	-	3,2	1
170540PEFR-S	-	-	-	-	-	-	-	-	●	●	-	-	4,0	1
170550PEFR-S	-	-	-	-	-	-	-	-	●	●	-	-	5,0	2
170564PEFR-S	-	-	-	-	-	-	-	-	●	●	-	-	6,4	2

Fig. 1

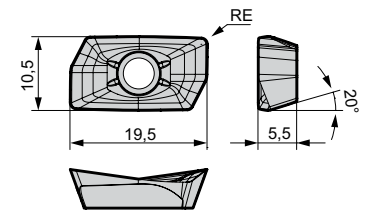
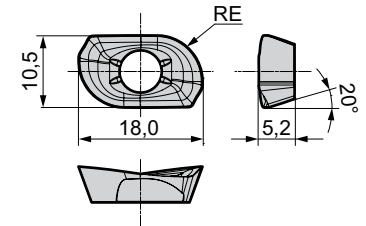

Fig. 2



L: Low cutting force  
G: General purpose  
H: Strong edge  
F: Finishing  
P: High-precision machining  
S: Non ferrous metals

# "Wave Mill" Series WEZR Type

**New**

Repeater



## ■ Features

- High-efficiency Shoulder Milling  
Inserts for "WaveMill" WEZ type are arranged in multiple stages forming a long cutting edge, to enable high-efficiency shoulder milling of deep steps.
- Very Low Vibration Tendency  
Sharp milling inserts and irregular pitched body help to reduce chatter marks caused by vibration.
- Support for all Types of Work Materials  
A lineup of grades specific to each work materials, as well as the general-purpose ACU2500 grade, which is applicable to steel, stainless steel and cast iron.

## ■ Body Features

- Improved Flute Shape

Optimised, upward tapering chip pocket geometry for improved chip removal and increased rigidity of the cutter body.

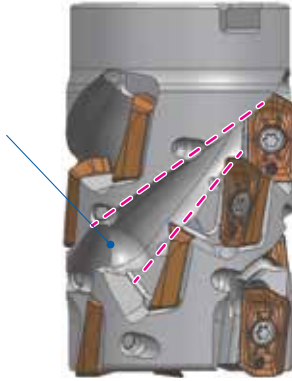

- Irregular Pitched Body

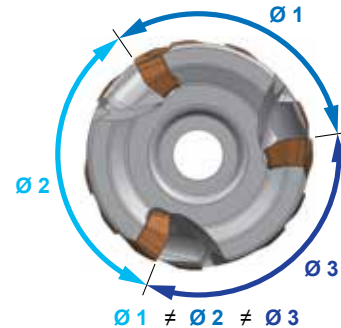

Irregular pitched body reduces vibration tendency

## ■ Cutting Performance

- Significantly less vibrations are a result of the combination of sharp inserts and irregular tooth pitch.

Capable of stable machining even with BT40 spindle machines

Vertical Machining Centre BT40

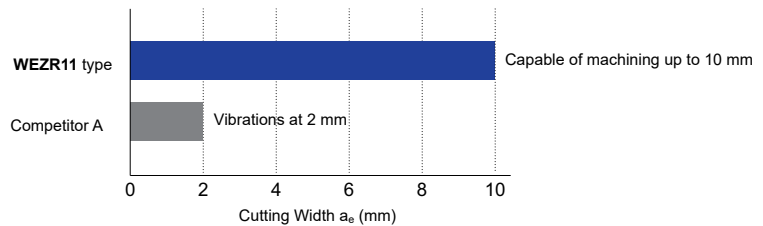

Machine: Vertical Machining Centre BT40,  
Work Material: C55, overhang amount 60 mm  
Tool: WEZR 11032E3632Z03 (Ø 32, 3 teeth, 4-stage)  
Insert: AOET11T308PEER-G (ACU2500)  
Cutting Conditions:  $v_c = 150$  m/min,  $f_z = 0,1$  mm/t,  $a_p = 30$  mm, dry

Capable of stable machining even with a long overhang

Vertical Machining Centre BT50

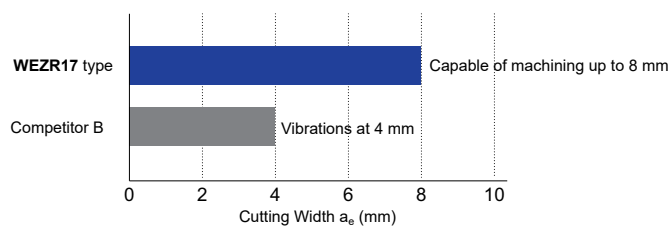
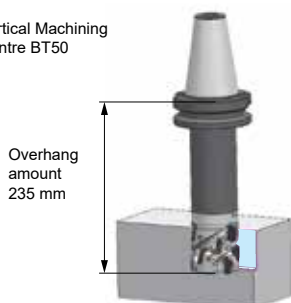

Machine: Vertical Machining Centre BT50,  
Work Material: 42CrMo4  
Tool: WEZR 17063RS5727Z04 (Ø 63, 4 teeth, 4-stage)  
Insert: AOET170508PEER-G (ACU2500)  
Cutting Conditions:  $v_c = 150$  m/min,  $f_z = 0,15$  mm/t,  $a_p = 50$  mm, dry

## ■ Cutting Performance

- Optimised cutting edge shape and high-precision molding technology result in excellent shoulder accuracy.

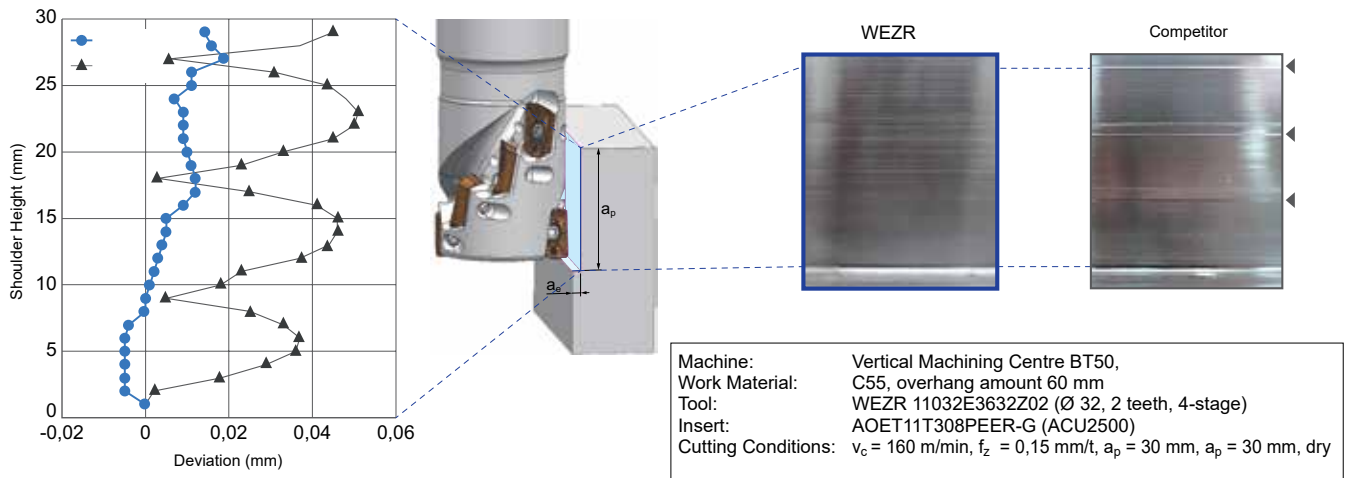

## ■ Application Range

- Steel, stainless steel, cast iron
- Aluminum alloys, titanium alloys

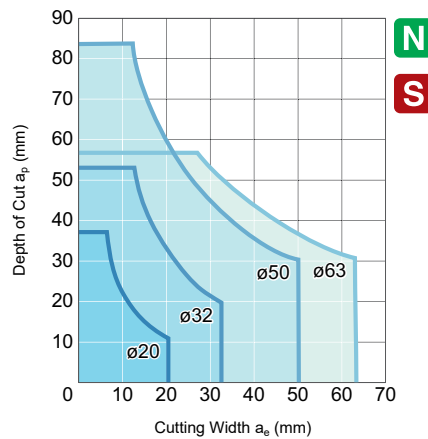
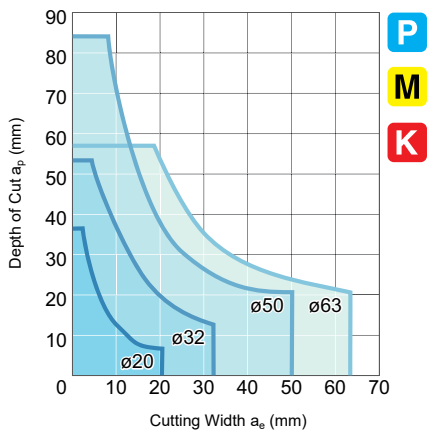

### Note:

The depth of cut figures above are guidelines for use with BT50 machine tools. Use a depth of cut of approximately 50% if using BT40.  
For a tool overhang of  $L/D = 3$  or  $L/D = 4$ , use a depth of cut of approximately 50% or 25%, respectively.  
There may be cases where machining cannot be performed at the depth of cut figures above, depending on the machine rigidity and work rigidity.  
Cutting speed and feed rate data you will find on the next pages.



# "Wave Mill" Series WEZR 11000 RS

**New**

Repeater

Rake Angle	Radial	-11° - -9°	44-53 mm	90°
	Axial	14° - 15°		

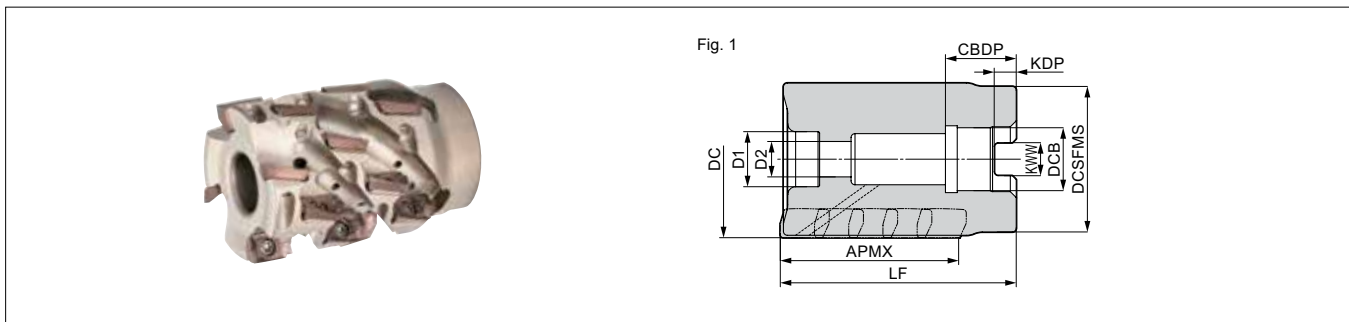

## Body (Shell Type)

Dimensions (mm)

Cat. No.		Stock	DC	APMX	DCSFMS	LF	DCB	KWW	KDP	CBDP	D1	D2	Total No. of Teeth	Steps	Effective No. of Teeth	Weight (kg)	Fig.
Metric	WEZR 11040RS4416Z04	○	40	44	37	60	16	8,4	5,6	18	14	9	20	5	4	0,27	1
	11050RS5322Z04	○	50	53	47	70	22	10,4	6,3	20	18	11	24	6	4	0,57	1

Take note of the cutter mounting size (DCB) when selecting a cutter. Inserts are sold separately.

## Spare Parts

Applicable Cutters	Insert Screw		Wrench	Bolt
	WEZR 11040RS4416Z04 11050RS5322Z04			
	BFTX0306IP	1,5	TRDR08IP	BX0850 BX1060

## Identification Details

**WEZR 11 040 R S 44 16 Z04**

Cutter Series	Insert Size	Cutter Diameter	Feed Direction	Metric	Max. Depth of Cut	Mounting Hole Diameter	Number of Teeth
WEZR 11	040	R	S	44	16	Z04	

## Recommended Cutting Conditions

ISO	Work Material	Hardness (HB)	Chipbreaker	Cutting Speed $v_c$ (m/min)	Feed Rate $f_z$ (mm/t)	Grades
P	Carbon Steel	≤ 280HB	G	100-150-200	0,08-0,12-0,20	ACU2500 XCU2500 ACP2000 ACP3000
	Alloy Steel	> 280HB	G	80-100-120	0,08-0,12-0,20	
M	Stainless Steel	≤ 280HB	G	80-120-160	0,08-0,12-0,20	ACU2500 ACM200 ACM300
K	Cast Iron Ductile Cast Iron	-	G	100-150-200	0,08-0,12-0,20	ACU2500 XCK2000 ACK2000 ACK3000
S	Exotic Alloy	-	G	40-50-60	0,08-0,12-0,20	ACU2500 ACM200 ACM300
N	Aluminum Alloy	Si ≤ 12,6%	S	300-500-800	0,05-0,10-0,15	DL2000 H20
		Si > 12,6%	S	100-200-250	0,05-0,10-0,15	

Min. - Optimum - Max.

Note:

The cutting conditions above are a guide. Actual conditions will need to be adjusted according to machine rigidity, work clamp rigidity, depth of cut and other factors. There may be cases where machining cannot be performed under recommended cutting conditions, depending on the machine rigidity and work rigidity.

\*When mounting inserts with nose radius of  $\geq 2,4$  mm, modification of the body is required.



Modify this edge.

Reworking guidelines  
 Corner radius = 2,4 mm: C = 1 mm (AOMT11T324PEER)  
 Corner radius = 3,0 mm: C = 1 mm (AOMT11T330PEER)  
 Corner radius = 3,2 mm: C = 1 mm (AOMT11T332PEER)  
 Standard: R = 1 mm

C: Chamfer  
 R: Radius

# "Wave Mill" Series WEZR 11000 RS

## ■ Inserts

Precautions for Mounting → G47

Application	Coated Carbide										Carbide	DLC	Cermets	RE		Fig.	
	ACU2500	XCU2500	ACP2000	ACP3000	XCK2000	ACK2000	ACK3000	ACM200	ACM300	H20							DL2000
High Speed / Light Cut																	
General Purpose																	
Roughing																	
Cat. No.																	
AOMT 11T302PEER-G	●		□	●		□	●	●	●	-	-	●	0,2	1			
11T304PEER-G	●	○	●	●	○	●	●	●	●	-	-	●	0,4	1			
11T305PEER-G	●		□	□		□	□	□	□	-	-	□	0,5	1			
11T308PEER-G	●	○	●	●	○	●	●	●	●	-	-	●	0,8	1			
11T310PEER-G	●		□	□		□	□	□	□	-	-	□	1,0	1			
11T312PEER-G	●		□	□		□	□	□	□	-	-	□	1,2	1			
11T316PEER-G	●		□	□		□	□	□	□	-	-	□	1,6	1			
11T320PEER-G	●		□	□		□	□	□	□	-	-	□	2,0	1			
11T324PEER-G	●		□	□		□	□	□	□	-	-	□	2,4	1			
11T330PEER-G	●		□	□		□	□	□	□	-	-	□	3,0	2			
11T332PEER-G	●		□	□		□	□	□	□	-	-	□	3,2	2			
AOMT 11T304PEER-H	●	○	●	●	○	●	●	●	●	-	-	-	0,4	1			
11T308PEER-H	●	○	●	●	○	●	●	●	●	-	-	-	0,8	1			
11T312PEER-H	●		□	□		□	□	□	□	-	-	-	1,2	1			
11T316PEER-H	●		□	□		□	□	□	□	-	-	-	1,6	1			
AOET 11T302PEER-F	●		-	-	-	-	-	-	-	-	-	-	0,2	1			
11T304PEER-F	●		-	-	-	-	-	-	-	-	-	-	0,4	1			
11T305PEER-F	●		-	-	-	-	-	-	-	-	-	-	0,5	1			
11T308PEER-F	●		-	-	-	-	-	-	-	-	-	-	0,8	1			
11T310PEER-F	●		-	-	-	-	-	-	-	-	-	-	1,0	1			
11T312PEER-F	●		-	-	-	-	-	-	-	-	-	-	1,2	1			
11T316PEER-F	●		-	-	-	-	-	-	-	-	-	-	1,6	1			
11T320PEER-F	●		-	-	-	-	-	-	-	-	-	-	2,0	1			
11T324PEER-F	●		-	-	-	-	-	-	-	-	-	-	2,4	1			
11T330PEER-F	●		-	-	-	-	-	-	-	-	-	-	3,0	2			
11T332PEER-F	●		-	-	-	-	-	-	-	-	-	-	3,2	2			
AOET 11T302PEFR-S	-	-	-	-	-	-	-	-	-	●	●	-	0,2	1			
11T304PEFR-S	-	-	-	-	-	-	-	-	-	●	●	-	0,4	1			
11T305PEFR-S	-	-	-	-	-	-	-	-	-	●	●	-	0,5	1			
11T308PEFR-S	-	-	-	-	-	-	-	-	-	●	●	-	0,8	1			
11T310PEFR-S	-	-	-	-	-	-	-	-	-	●	●	-	1,0	1			
11T312PEFR-S	-	-	-	-	-	-	-	-	-	●	●	-	1,2	1			
11T316PEFR-S	-	-	-	-	-	-	-	-	-	●	●	-	1,6	1			
11T320PEFR-S	-	-	-	-	-	-	-	-	-	●	●	-	2,0	1			
11T324PEFR-S	-	-	-	-	-	-	-	-	-	●	●	-	2,4	1			
11T330PEFR-S	-	-	-	-	-	-	-	-	-	●	●	-	3,0	2			
11T332PEFR-S	-	-	-	-	-	-	-	-	-	●	●	-	3,2	2			

Dimensions (mm)

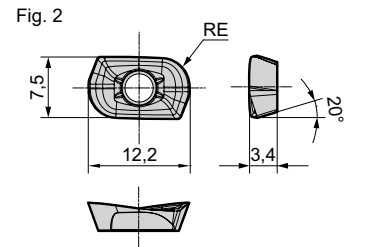
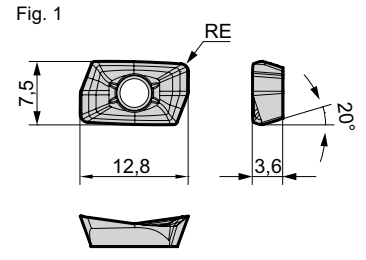

- L: Low cutting force
- G: General purpose
- H: Strong edge
- F: Finishing
- P: High-precision machining
- S: Non ferrous metals

# "Wave Mill" Series WEZR 17000 RS



Repeater

Rake Angle	Radial	-8° - -6°	29-57 mm	90°
	Axial	7° - 15°		

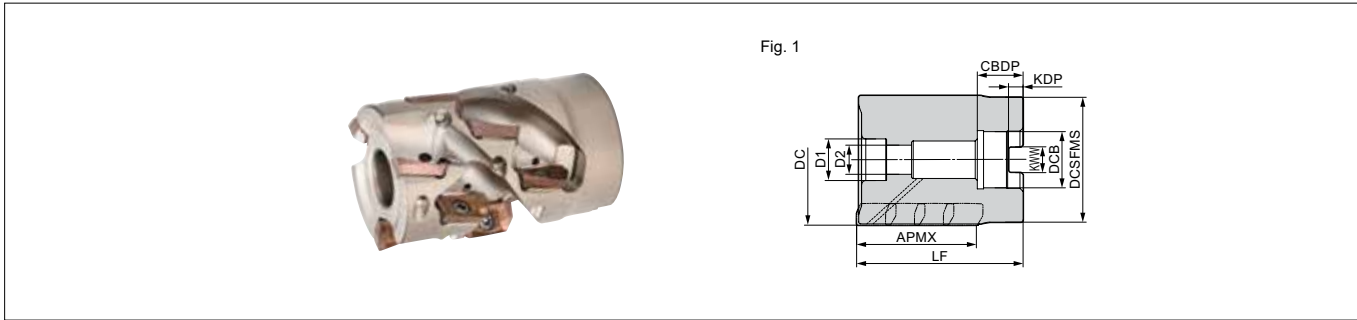

## Body (Shell Type)

Cat. No.		Stock	DC	APMX	DCSFMS	LF	DCB	KWW	KDP	CBDP	D1	D2	Total No. of Teeth	Steps	Effective No. of Teeth	Weight (kg)	Fig.
Metric	WEZR 17050RS2922Z04	○	40	29	47	50	22	10,4	6,3	20	18	11	8	2	4	0,35	1
	17050RS5722Z02	○	50	57	47	80	22	10,4	6,3	20	18	11	8	4	2	0,70	1
	17050RS5722Z03	○	50	57	47	80	22	10,4	6,3	20	18	11	12	4	3	0,59	1
	17063RS2927Z05	○	63	29	60	55	27	12,4	7	22	20	14	10	2	5	0,74	1
	17063RS5727Z03	○	63	57	60	80	27	12,4	7	22	20	14	12	4	3	1,11	1
	17063RS5727Z04	○	63	57	60	80	27	12,4	7	22	20	14	16	4	4	1,05	1
	17080RS5627Z05	○	80	56	70	80	27	12,4	7	22	20	14	20	4	5	1,85	1
	17080RS5632Z05	○	80	56	70	80	32	14,4	8	26	25	18	20	4	5	1,76	1

Take note of the cutter mounting size (DCB) when selecting a cutter. Inserts are sold separately.

## Spare Parts

Applicable Cutters	Insert Screw		Wrench	Handle Grip	Wrench Bit	Bolt
		(N·m)				
WEZR 17050RS2922Z04	BFTX0409IP	3,0	-	HPS1015	TRB15IP	BX1045
17050RS5722Z02						BX1070
17050RS5722Z03						BX1240
17063RS2927Z05						BX1265
17063RS5727Z03						BX1265
17063RS5727Z04						BX1265
17080RS5627Z05						BX1660
17080RS5632Z05						BX1660
			TRDR15IP	-	-	

## Identification Details

**WEZR 17 050 R S 29 22 Z04**

Cutter Series	Insert Size	Cutter Diameter	Feed Direction	Metric	Max. Depth of Cut	Mounting Hole Diameter	Number of Teeth
WEZR	17	050	R	S	29	22	Z04

## Recommended Cutting Conditions

ISO	Work Material	Hardness (HB)	Chipbreaker	Cutting Speed v <sub>c</sub> (m/min)	Feed Rate f <sub>z</sub> (mm/t)	Grades
P	Carbon Steel	≤ 280HB	G	100-150-200	0,10-0,20-0,30	ACU2500 XCU2500 ACP2000 ACP3000
	Alloy Steel	> 280HB	G	80-100-120	0,10-0,20-0,30	
M	Stainless Steel	≤ 280HB	G	100-150-80	0,10-0,20-0,30	ACU2500 ACM200 ACM300
K	Cast Iron Ductile Cast Iron	-	G	100-150-200	0,10-0,20-0,30	ACU2500 XCK2000 ACK2000 ACK3000
S	Exotic Alloy	-	G	40-50-60	0,10-0,20-0,30	ACU2500 ACM200 ACM300
N	Aluminum Alloy	Si ≤ 12,6%	S	300-500-800	0,05-0,10-0,15	DL2000 H20
		Si > 12,6%	S	100-200-250	0,05-0,10-0,15	

Min. - Optimum - Max.

Note:

The cutting conditions above are a guide. Actual conditions will need to be adjusted according to machine rigidity, work clamp rigidity, depth of cut and other factors. There may be cases where machining cannot be performed under recommended cutting conditions, depending on the machine rigidity and work rigidity.

\*When mounting inserts with nose radius of ≥ 2,4 mm, modification of the body is required.



Modify this edge.

Reworking guidelines

- Corner radius = 2,4 mm: C = 1 mm (AOMT170524PEER)
- Corner radius = 3,0 mm: C = 1 mm (AOMT170530PEER)
- Corner radius = 3,2 mm: C = 1 mm (AOMT170532PEER)
- Corner radius = 4,0 mm: C = 2 mm (AOMT170540PEER)
- Corner radius = 5,0 mm: C = 5 mm (AOMT170550PEER)
- Corner radius = 6,4 mm: C = 5 mm (AOMT170564PEER)
- Standard: R = 1 mm
- C: Chamfer
- R: Radius

# "Wave Mill" Series WEZR 17000 RS

## ■ Inserts

## Precautions for Mounting → G47

Dimensions (mm)

Application	Coated Carbide										Carbide	DLC	Cermet	RE	Fig.
	ACU2500	XCU2500	ACP2000	ACP3000	XCK2000	ACK2000	ACK3000	ACM200	ACM300	H20					
High Speed / Light Cut	●	●	●	●	●	●	●	●	●	●		●	●		
General Purpose	●	●	●	●	●	●	●	●	●	●	●	●	●		
Roughing	●	●	●	●	●	●	●	●	●	●	●	●	●		
Cat. No.	ACU2500	XCU2500	ACP2000	ACP3000	XCK2000	ACK2000	ACK3000	ACM200	ACM300	H20	DL2000	T2500A	RE	Fig.	
AOMT 170502PEER-L	●			□			□	●	●			□	0,2	1	
170504PEER-L	●	○			○			●	●			●	0,4	1	
170508PEER-L	●	○		●	○			●	●			●	0,8	1	
170512PEER-L	●			□			□	●	●				1,2	1	
170516PEER-L	●			□			□	●	●				1,6	1	
AOMT 170502PEER-G	●		□	●		□	●	●	●			□	0,2	1	
170504PEER-G	●	○	●	□	○	●	□	●	●			●	0,4	1	
170505PEER-G	●		□	□		□	□	●	●			□	0,5	1	
170508PEER-G	●	○	●	□	○	●	□	●	●			●	0,8	1	
170510PEER-G	●		□	□		□	□	●	●			□	1,0	1	
170512PEER-G	●		□	□		□	□	●	●			□	1,2	1	
170516PEER-G	●		□	□		□	□	●	●				1,6	1	
170520PEER-G	●		□	□		□	□	●	●				2,0	1	
170524PEER-G	●		□	□		□	□	●	●				2,4	1	
170530PEER-G	●		□	□		□	□	●	●				3,0	1	
170532PEER-G	●		□	□		□	□	●	●				3,2	1	
170540PEER-G	●		□	□		□	□	●	●				4,0	1	
170550PEER-G	●		□	□		□	□	●	●				5,0	2	
170564PEER-G	●		□	□		□	□	●	●				6,4	2	
AOMT 170504PEER-H	●	○	●	●	○	●	●	●	●				0,4	1	
170508PEER-H	●	○	●	●	○	●	●	●	●				0,8	1	
170512PEER-H	●		□	□		□	□	●	●				1,2	1	
170516PEER-H	●		□	□		□	□	●	●				1,6	1	
AOET 170502PEER-F	●												0,2	1	
170504PEER-F	●												0,4	1	
170505PEER-F	●												0,5	1	
170508PEER-F	●												0,8	1	
170510PEER-F	●												1,0	1	
170512PEER-F	●												1,2	1	
170516PEER-F	●												1,6	1	
170520PEER-F	●												2,0	1	
170524PEER-F	●												2,4	1	
170530PEER-F	●												3,0	1	
170532PEER-F	●												3,2	1	
170540PEER-F	●												4,0	1	
170550PEER-F	●												5,0	2	
170564PEER-F	●												6,4	2	
AOET 170502PEFR-S										●	●		0,2	1	
170504PEFR-S										●	●		0,4	1	
170505PEFR-S										●	●		0,5	1	
170508PEFR-S										●	●		0,8	1	
170510PEFR-S										●	●		1,0	1	
170512PEFR-S										●	●		1,2	1	
170516PEFR-S										●	●		1,6	1	
170520PEFR-S										●	●		2,0	1	
170524PEFR-S										●	●		2,4	1	
170530PEFR-S										●	●		3,0	1	
170532PEFR-S										●	●		3,2	1	
170540PEFR-S										●	●		4,0	1	
170550PEFR-S										●	●		5,0	2	
170564PEFR-S										●	●		6,4	2	

Fig. 1

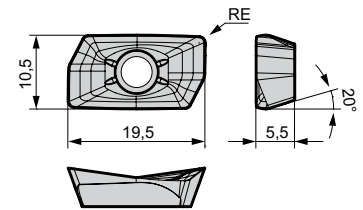
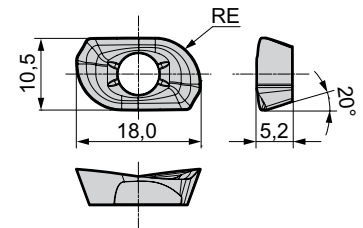

Fig. 2



L: Low cutting force  
G: General purpose  
H: Strong edge  
F: Finishing  
P: High-precision machining  
S: Non ferrous metals

# "Wave Mill" Series WEX (-F) Type

5 mm 90°

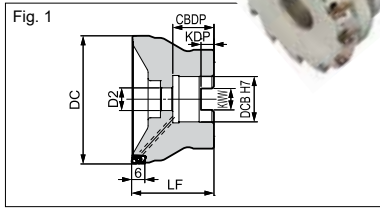

10 mm 90°

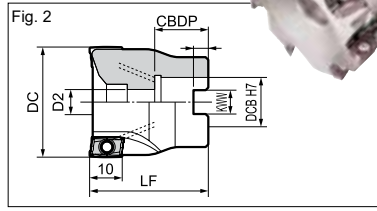

14 mm 90°

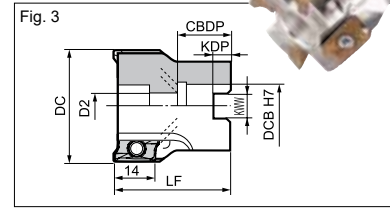

## Body (Shell Type "F")

Cat. No.	Dimensions (mm)								No. of Teeth	Fig.
	Stock	DC	DCB	D2	KWW	KDP	LF	CBDP		
WEX 1032 F	▲	32	16	9	8,4	5,6	40	18	8	1
1040 F	▲	40	16	11	8,4	5,6	40	18	10	1
1050 F	▲	50	22	11	10,4	6,3	40	20	12	1
1063 F	▲	63	22	11	10,4	6,3	40	20	14	1
WEX 2040 F	▲	40	16	9	8,4	5,6	40	18	6	2
2050 F	▲	50	22	11	10,4	6,3	40	20	7	2
2063 F	▲	63	22	11	10,4	6,3	40	20	8	2
2080 F	▲	80	27	13,5	12,4	7,0	50	25	10	2
WEX 2100 F	□	100	32	32	14,4	8,5	50	26	12	2
WEX 3040 F	▲	40	16	9	8,4	5,6	40	18	4	3
3050 F	▲	50	22	11	10,4	6,3	40	20	5	3
3063 F	▲	63	22	11	10,4	6,3	40	20	6	3
3080 F	▲	80	27	13,5	12,4	7,0	50	25	7	3
WEX 3100 F	▲	100	32	32	14,4	8,5	50	26	8	3

## Inserts for WEX1000 / 2000 Type

Application	Coated Carbide								Carbide		DLC
	P	M	K	M	S	M	S	K	N	N	
High Speed / Light cut	P		K	M	S			K	N	N	
General Purpose	P	M	K	M	S	M	S	K	N	N	
Roughing	P	M	K	M	S	M	S	K	N	N	
Cat. No.	ACP100	ACP200	ACP300	ACK200	ACK300	ACM200	ACM800	H1	DL1000	Radius	RE
AXMT 060204 PDER-L	▲	▲	▲	▲	▲	▲	▲			0,4	
060208 PDER-L	▲	▲	▲	▲	▲	▲	▲			0,8	
060212 PDER-L	▲	▲	▲	○	▲	▲	▲			1,2	
AXMT 060204 PDER-G	▲	▲	▲	○	▲	▲	▲			0,4	
060208 PDER-G	▲	▲	▲	▲	▲	▲	▲			0,8	
060212 PDER-G	○	▲	▲	▲	▲	▲	▲			1,2	
AXMT 060204 PDER-H	○	▲	▲		▲	▲	▲			0,4	
060208 PDER-H	▲	▲	▲		▲	▲	▲			0,8	
060212 PDER-H	○	▲	▲		▲	▲	▲			1,2	
AXMT 123504 PEER-G	▲	▲	▲	▲	▲			-	-	0,4	
123508 PEER-G	▲	▲	▲	▲	▲			-	-	0,8	
123512 PEER-G	▲	▲	▲	▲	▲			-	-	1,2	
AXMT 123504 PEER-H	▲	▲	▲	▲	▲			-	-	0,4	
123508 PEER-H	▲	▲	▲	▲	▲			-	-	0,8	
123512 PEER-H	▲	▲	▲	▲	▲			-	-	1,2	
AXMT 123504 PEER-E						▲	▲	-	-	0,4	
123508 PEER-E						▲	▲	-	-	0,8	
123512 PEER-E						▲	▲	-	-	1,2	
AXMT 123508 PEER-EH						▲	▲	-	-	0,8	
AXMT 060202 PDFR-S	-	-	-	-	-	-	-	○	○	0,2	
AXET 123502 PEFR-S	-	-	-	-	-	-	-	▲	▲	0,2	
123504 PEFR-S	-	-	-	-	-	-	-	▲	▲	0,4	
123508 PEFR-S	-	-	-	-	-	-	-	▲	▲	0,8	

## Spare Parts

Screw	Wrench	Applicable Endmill
BFTX 01804 IP	TRX 06 IP	0,5 WEX 1000 F
BFTX 0306 IP	TRDR 08 IP	2,0 WEX 2000 F
BFTX 0409 IP	TRDR 15 IP	3,0 WEX 3000 F

## Inserts for WEX3000 Type

Application	Coated Carbide								Carbide		DLC
	P	M	K	M	S	M	S	K	N	N	
High Speed / Light cut	P		K	M	S			K	N	N	
General Purpose	P	M	K	M	S	M	S	K	N	N	
Roughing	P	M	K	M	S	M	S	K	N	N	
Cat. No.	ACP100	ACP200	ACP300	ACK200	ACK300	ACM200	ACM800	H1	DL1000	Radius	RE
AXMT 170508 PEER-L	▲	▲	▲	▲	▲			-	-	0,8	
AXMT 170504 PEER-G	▲	▲	▲	▲	▲			-	-	0,4	
170508 PEER-G	▲	▲	▲	▲	▲			-	-	0,8	
170512 PEER-G	▲	▲	▲	▲	▲			-	-	1,2	
170516 PEER-G	○	▲	▲	▲	▲			-	-	1,6	
170520 PEER-G*	▲	▲	▲	▲	▲			-	-	2,0	
170530 PEER-G*	▲	▲	▲	▲	▲			-	-	3,0	
AXMT 170508 PEER-H	▲	▲	▲	▲	▲			-	-	0,8	
170512 PEER-H	▲	▲	▲	▲	▲			-	-	1,2	
AXMT 170504 PEER-E						▲	▲	-	-	0,4	
170508 PEER-E						▲	▲	-	-	0,8	
170512 PEER-E						▲	▲	-	-	1,2	
170516 PEER-E						▲	▲	-	-	1,6	
170520 PEER-E*						▲	▲	-	-	2,0	
170530 PEER-E*						▲	▲	-	-	3,0	
AXMT 170508 PEER-EH			▲			▲	▲	-	-	0,8	
AXET 170502 PEFR-S	-	-	-	-	-	-	-	▲	▲	0,2	
170504 PEFR-S	-	-	-	-	-	-	-	▲	▲	0,4	
170508 PEFR-S	-	-	-	-	-	-	-	▲	▲	0,8	

\* Cutter body modification is required.

- Unable to produce
- L - Low cutting force
- G - General type
- H - Strong cutting edge
- E - For stainless steel
- EH - Strong edge for stainless steel
- S - For aluminium

## Identification Details

**WEX**      **2**      **016**      **F**  
Cutter Series      2000 Series      Cutter Diameter      Shell Type

# Wave Repeater Mill WRX (-F) Type

18-36 mm 90°

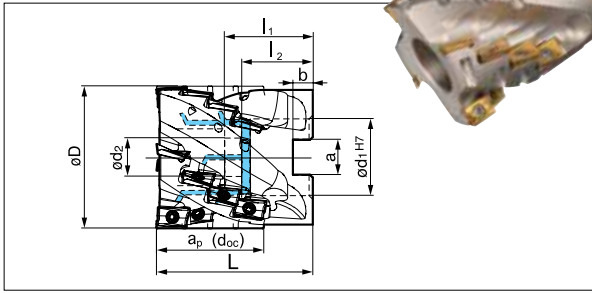

27-53 mm 90°

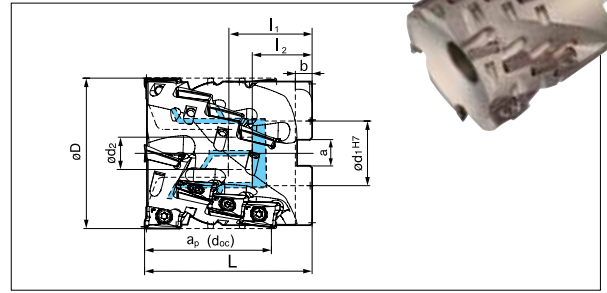

## Body (Shell Type "F")

Cat. No.	Stock	Depth of cut (a <sub>p</sub> )	Dimensions (mm)									No. of teeth	No. of rows	Effective teeth
			øD	ød <sub>1</sub>	ød <sub>2</sub>	a	b	l <sub>1</sub>	l	l	l			
WRX2040RH18F16	□	18	40	16	9	8,4	5,6	50	39	18	10	2	5	
WRX2040RH36F16	●	36	40	16	9	8,4	5,6	55	44	18	16	4	4	
WRX2050RH18F22	□	18	50	22	11	10,4	6,3	50	36	20	10	2	5	
WRX2050RH36F22	●	36	50	22	11	10,4	6,3	55	41,5	20	16	4	4	

## Body (Shell Type "F")

Cat. No.	Stock	Depth of Cut (a <sub>p</sub> )	Dimensions (mm)									No. of teeth	No. of rows	Effective teeth
			øD	ød <sub>1</sub>	ød <sub>2</sub>	a	b	l <sub>1</sub>	l	l	l			
WRX3050RH27F22	□	27	50	22	11	10	6,3	50	36	20	8	2	4	
WRX3050RH53F22	●	53	50	22	11	10	6,3	70	56	20	12	4	3	
WRX3063RH27F27	□	27	63	27	13,5	12	7	70	34	2	10	2	5	
WRX3063RH53F27	●	53	63	27	13,5	12	7	70	54	2	16	4	4	
WRX3080RH27F32	□	27	80	32	17	14	8	50	30	2	12	2	6	
WRX3080RH53F32	●	53	80	32	17	14	8	85	63	2	20	4	5	
WRX3100RH27F40	□	27	100	40	21	16	9,5	85	40	30	14	2	7	
WRX3100RH53F40	●	53	100	40	21	16	9,5	85	59	30	24	4	6	

## Inserts (Same as for Wavemill WEX 2000 Type)

Application	Coated Carbide							Carbide		DLC
	P	P	K	M	M	M	H1	DL1000	RE	
High Speed / Light cut	■			■	■	■				
General Purpose	■	■	■	■	■	■				
Roughing	■	■	■	■	■	■				
Cat. No.	ACP100	ACP200	ACP300	ACK200	ACK300	ACM200	ACM300	H1	DL1000	Radius
AXMT 123504 PEER-G	▲	▲	▲	▲	▲					0,4
123508 PEER-G	▲	▲	▲	▲	▲					0,8
123512 PEER-G	▲	▲	▲	▲	▲					1,2
AXMT 123504 PEER-H	▲	▲	▲	▲	▲					0,4
123508 PEER-H	▲	▲	▲	▲	▲					0,8
123512 PEER-H	▲	▲	▲	▲	▲					1,2
AXMT 123504 PEER-E						▲	▲			0,4
123508 PEER-E						▲	▲			0,8
123512 PEER-E						▲	▲			1,2
AXMT 123508 PEER-EH						▲	▲			0,8
AXET 123502 PEFR-S								▲	▲	0,2
123504 PEFR-S								▲	▲	0,4
123508 PEFR-S								▲	▲	0,8

- Unable to produce  
 L - Low cutting force  
 G - General type  
 H - Strong cutting edge  
 E - For stainless steel  
 EH - Strong edge for stainless steel  
 S - For aluminium

## Spare Parts

Screw	Wrench	Applicable Endmill
BFTX 0306 IP	TRDR 08 IP	WRX 2 ___ RH _F _
BFTX 0409 IP	TRDR 15 IP	WRX 3 ___ RH _F _

## Inserts (Same as for Wavemill WEX 3000 Type)

Application	Coated Carbide							Carbide		DLC
	P	P	K	M	M	M	H1	DL1000	Radius	
High Speed / Light cut	■			■	■	■				
General Purpose	■	■	■	■	■	■				
Roughing	■	■	■	■	■	■				
Cat. No.	ACP100	ACP200	ACP300	ACK200	ACK300	ACM200	ACM800	H1	DL1000	Radius
AXMT 170508 PEER-L	▲	▲	▲	▲	▲					0,8
AXMT 170504 PEER-G	▲	▲	▲	▲	▲					0,4
170508 PEER-G	▲	▲	▲	▲	▲					0,8
170512 PEER-G	▲	▲	▲	▲	▲					1,2
170516 PEER-G	○	▲	▲	▲	▲					1,6
170520 PEER-G*	▲	▲	▲	▲	▲					2,0
170530 PEER-G*	▲	▲	▲	▲	▲					3,0
AXMT 170508 PEER-H	▲	▲	▲	▲	▲					0,8
170512 PEER-H	▲	▲	▲	▲	▲					1,2
AXMT 170504 PEER-E						▲	▲			0,4
170508 PEER-E						▲	▲			0,8
170512 PEER-E						▲	▲			1,2
170516 PEER-E						▲	▲			1,6
170520 PEER-E*						▲	▲			2,0
170530 PEER-E*						▲	▲			3,0
AXMT 170508 PEER-EH				▲		▲	▲			0,8
AXET 170502 PEFR-S								▲	▲	0,2
170504 PEFR-S								▲	▲	0,4
170508 PEFR-S								▲	▲	0,8

\* Cutter body modification is required.

## Identification Details

WRX	20	40	R	H	18	F	16
	Insert Size	Tool øD	Cutting Direction	Inner coolant	Cutting Edge Length	Arbor Type	Arbor Diameter
						↓	
						E - Straight Shank	
						W - Weldon Shank	
						F - Shell Type	





## General Features

### Stable and Reliable Tool Life in Titanium Roughing

With combination of high toughness grade ACM300 and optimized cutting edge shape, stable and reliable tool life are achieved in roughing application of Titanium.

### Suitable for Titanium Structure Parts for Aircraft

MTIX cutter with wide range of insert nose-radius and large ramping angle availability is suitable for variable application of titanium structure parts for aircraft.

### Large Application Range

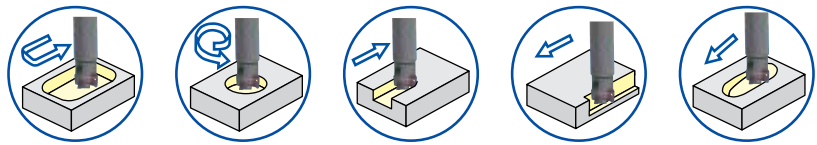

ISO	Grade	Coating Thickness (µm)	Features
<b>S</b>	ACM300	3	Realises superb stability in machining of Titanium, due to a high-strength carbide substrate and highly chipping-resistance coating.

## Recommended Cutting Conditions

Min. - Optimum - Max.

ISO	Material	Cutting Speed (m/min)	Feed Rate (mm/t)	$a_p$ (mm)	Grade
<b>S</b>	Titanium	30-60-90	0,05-0,10-0,15	<13	ACM300

## Ramping / Helical Milling Upper Limits

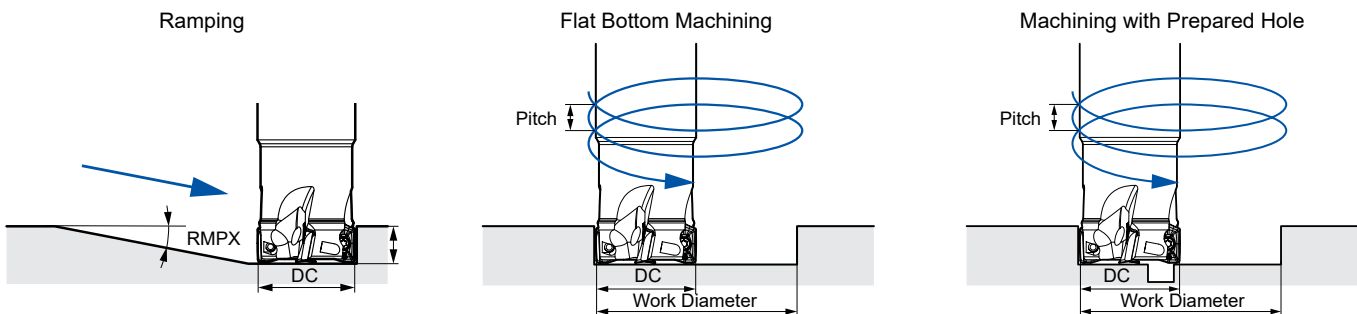

Tools			Flat Bottom Machining				Machining with Prepared Hole	
DC Ø (mm)	Nose Radius	Ramping	DC Ø (mm)	Nose Radius	Max. Machining Diam. (mm)	Max. Pitch (mm/rev)	Min. Machining Diam. (mm)	Max. Pitch (mm/rev)
Ø 32	RE ≥ 5,0	8,4	Ø 32	4,0	55,3	13,0	55,2	13,0
	RE ≤ 4,0	12,2		0,8	61,3	13,0	56,3	13,0
Ø 50	RE ≥ 5,0	3,6	Ø 50	4,0	91,6	11,2	91,6	11,2
	RE ≤ 4,0	5,6		0,8	97,3	13,0	92,2	11,0
Ø 63	RE ≥ 5,0	2,5	Ø 63	4,0	117,6	10,1	117,6	10,1
	RE ≤ 4,0	3,9		0,8	123,3	11,7	118,2	9,9

# MTIX 16000 Type

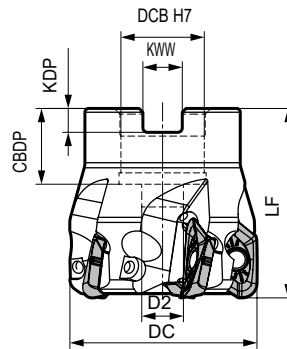

Rake Angle	Radial	-9° - -6°	13 mm	90°
	Axial	8° - 14°		

## Body - MTIX (Shell Type)

Dimensions (mm)

Insert Radius RE	Cat. No.	Stock	DC	DCB	LF	D2	KWW	KDP	CDBP	No. of Teeth	Weight (kg)
≤ 4,0	MTIX 16050RS05	●	50	22	50	11	10,4	6,3	20	5	0,33
	16063RS06	●	63	22	50	11	10,4	6,3	20	6	0,34
≥ 5,0	MTIX16050RS05-5,0	●	50	22	50	11	10,4	6,3	20	5	0,62
	16063RS06-5,0	●	63	22	50	11	10,4	6,3	20	6	0,63

→ H69

Inserts are sold separately.

## Spare Parts

Applicable Cutters	Insert Screw		Wrench	Handle Grip	Wrench Bit
MTIX 16050RS05(-5,0) 16063RS06(-5,0)	BFTX0409IP	3,0	-	HPS1015	TPB15IP

## Identification Details

<b>MTIX</b>	<b>16</b>	<b>050</b>	<b>R</b>	<b>S</b>	<b>05</b>
Cutter Series	Insert Size	Cutter Diameter	Feed Direction	Metric	Number of Teeth

## Inserts

Application	Coated Carbide				Dimensions (mm)	
High Speed / Light Cut						
General Purpose	<b>S</b>					
Roughing	<b>S</b>					
Cat. No.	ACM300	RE (mm)	Fig.			
XOMT 160508PEER-E	●	0,8	1	21,5	18,1	5,5
160512PEER-E	●	1,2	1			
160516PEER-E	●	1,6	1			
160520PEER-E	●	2,0	1			
160530PEER-E	●	3,0	1			
160540PEER-E	●	4,0	1			
160550PEER-E	●	5,0	2			
160560PEER-E	●	6,0	2			
160564PEER-E	●	6,35	2			

Inserts with nose radius of RE ≥ 5,0 are for use with bodies that have a "-5,0" part number suffix

## ■ Precautions for Mounting

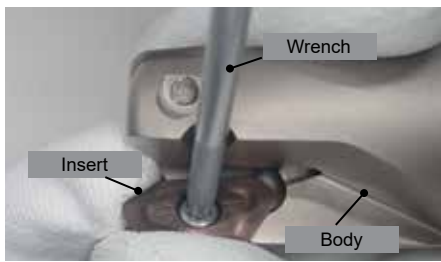

- (1) Clean the mounting seat and contact parts.
- (2) Apply screw lubrication to the screw thread as well as the screw head face to prevent seizure.
- (3) While pressing the insert solidly against the seat surface, tighten at the screws with the included wrench.
- (4) After tightening, check that there are no gaps between the surfaces.

Cutter Body	MTIX16 ____	MTIX16 ____ -5,0
Insert Radius $RE \leq 4,0 \text{ mm}$	<b>OK</b>	Not recommended. The insert has no support from the cutter body.
Insert Radius $RE \geq 4,0 \text{ mm}$	<b>OK with modification</b>  1,5 mm less height	<b>OK</b> 
<b>Modification method</b> ① Grind 1,5 mm from top ② Add chamfer 4,5 mm		

## ■ Cutting Performance

Ti 6Al4V, Machine: DMU80P (HSK100)	
Cutter: Dia. 50 mm, 5 teeth, Insert: 16-18 size, R 4,0	
$v_c = 60 \text{ m/min}$ $f_z = 0,12 \text{ mm/teeth}$ $a_p = 10 \text{ mm}$ $a_e = 21 \text{ mm}$ HP coolant 70 bar	<b>MTIX</b> <b>Competitor</b>
$v_c = 50 \text{ m/min}$ $f_z = 0,12 \text{ mm/teeth}$ $a_p = 4 \text{ mm}$ $a_e = 50 \text{ mm}$ HP coolant 70 bar	<b>MTIX</b> <b>Competitor</b>
$v_c = 50 \text{ m/min}$ $f_z = 0,12 \text{ mm/teeth}$ $a_p = 4 \text{ mm}$ $a_e = 50 \text{ mm}$ HP coolant 70 bar	<b>MTIX</b> <b>Competitor</b>

## ■ Application Example

Structural Parts, Ti 6Al4V, Countering / Ramping

ACM300 achieved twice longer tool life against competitor's grade.

Cutter:	MTIX 16050RS05 (Ø 50, No. of teeth:5)
Insert:	XOMT 160540 PEER-E (ACM300)
Cutting Data:	$v_c = 50 \text{ M/min}$ , $a_p = 4 \text{ mm}$ , $f_z = 0,12 \text{ mm/t}$ , $a_e = 10 \text{ mm}$ , wet



# "Sumi Dual Mill" DMSW Series



## General Features

- High productivity thanks to an ultra-high metal removal rate as well as high economic efficiency, due to the stable six-edged insert.
- The arc-shaped cutting edge reduces the cutting force to a minimum. High-efficiency machining at maximum feed rate per tooth of 3,5 mm/t is possible.

## Application Range

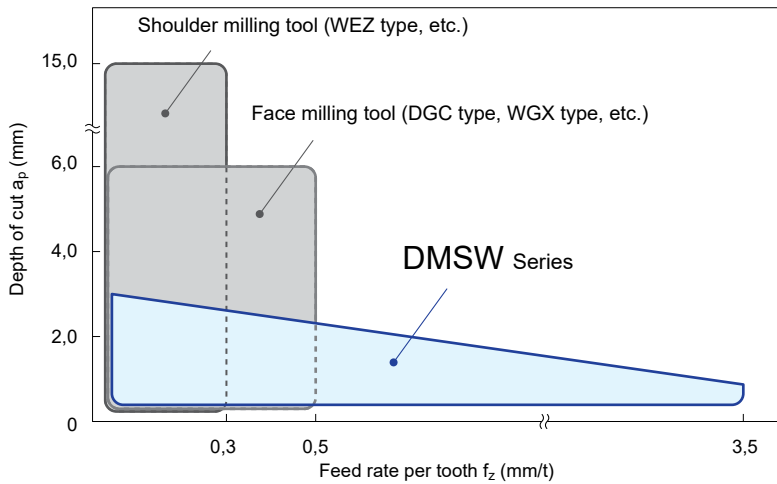

- Cutting depths up to 3 mm can be achieved. Feed rate per tooth up to 3,5 mm/t.
- Increases productivity.

## Product Range

Type	Cat. No.	Diameter range (mm) / No of teeth											Shape	
		Ø35	Ø40	Ø42	Ø50	Ø52	Ø63	Ø66	Ø80	Ø85	Ø100	Ø125		Ø160
Shell	DMSW 08000RS				4 5	4 5	4 5*	5 6	6 8	6 8	6	8	10	
	DMSW 08000R (Inch)				4 5		4 5 6		6 8		6	8	10	
Shank	DMSW 08000E	2	3		3		4							
	DMSW 08000EL	2	3		3		4					→ H8		
Modular	DMSW 08000M	2	3	3								→ H9		

\* Different shank diameters in stock

## Chipbreaker

Work Material	<b>P</b> Steel <b>M</b> Stainless steel <b>K</b> Cast iron	<b>P</b> Steel <b>M</b> Stainless steel <b>K</b> Cast iron
Applications	Main chipbreaker general-purpose to interrupted milling	Roughing, heavy interrupted cutting and hardened steel milling
Chip breaker	General purpose <b>G</b> type 	High strength <b>H</b> type 
	 0,12 mm 15°	 0,22 mm 15°
Cutting edge cross section		

## Chipbreaker Selection Guide

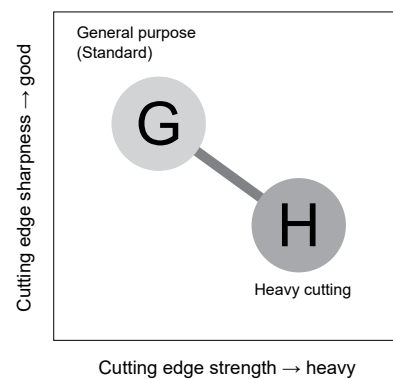

# "Sumi Dual Mill" DMSW Series



## Features

- A small chip cross-section due to a small cutting angle enables high feed rates per tooth.

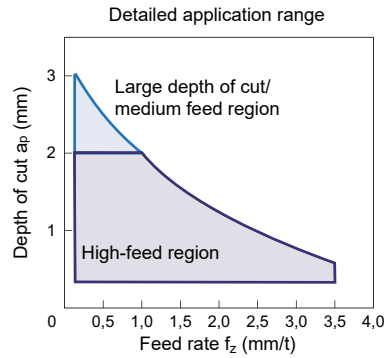
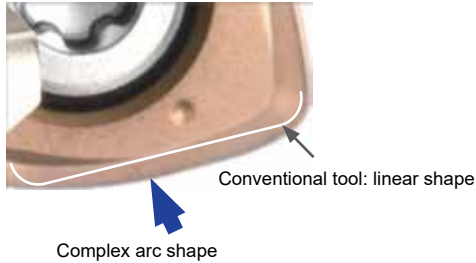

- Economical double-sided insert with 6-corner specification. Reassuring thick at 7 mm.

WNMU type



Conventional tool

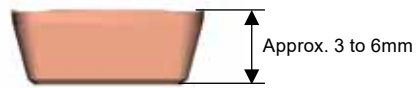

- Even at high feedrates of 2,0 mm/t or more, a reasonable surface finish can be attained.

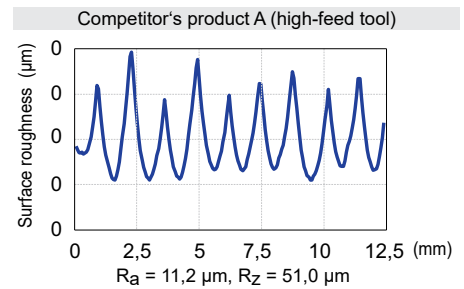
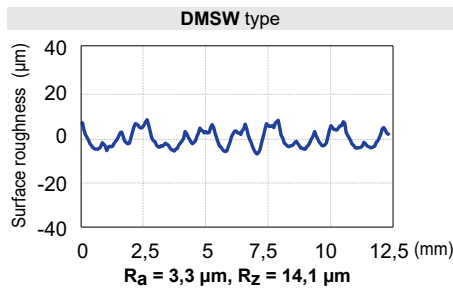
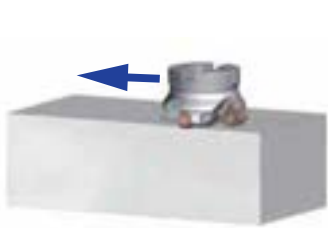

Machine:	Vertical machining centre BT50,	Work material:	C50	Insert:	WNMU 0807ZNER-G (ACU2500)
Tool:	DMSW 08063RS04	Cutting data:	$v_c = 150$ m/min, $f_z = 2,5$ mm/t, $a_p = 0,5$ mm, $a_e = 40$ mm, dry		

- Small cutting angle (15°) controls cutting force toward the back force direction. Suppresses chatter in long tool overhang machining, increasing efficiency.

DMSW type

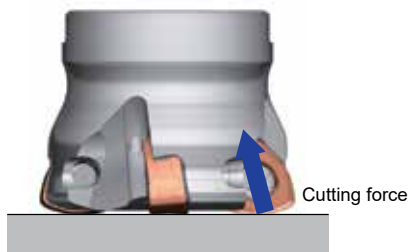

(Reference) Shoulder milling tool

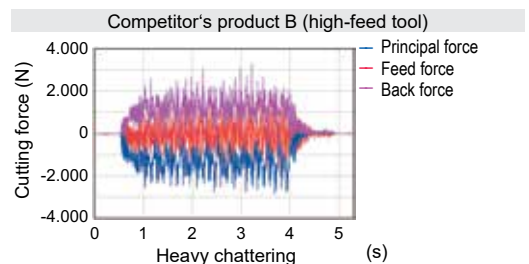
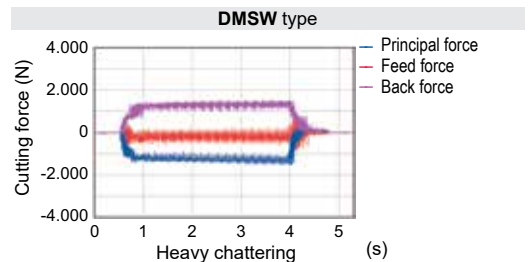
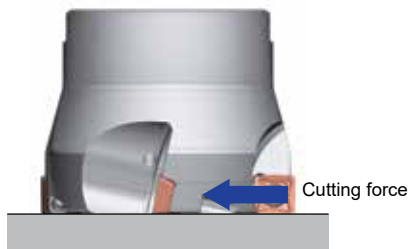

Machine:	Vertical machining centre BT50,	Work material:	C50
Tool:	DMSW 08050RS04	Insert:	WNMU 0807ZNER-G (ACU2500)
Cutting data:	$v_c = 160$ m/min, $f_z = 0,65$ mm/t, $a_p = 0,80$ mm, $a_e = 45$ mm, dry		

## ■ Precautions for Corner Finishing

Actual machined corners will have uncut and overcut portions due to the shape of the inserts.

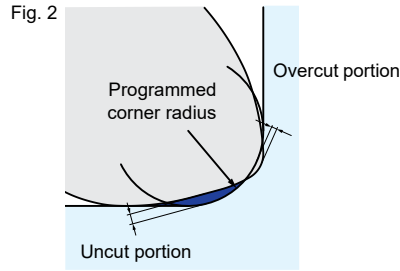
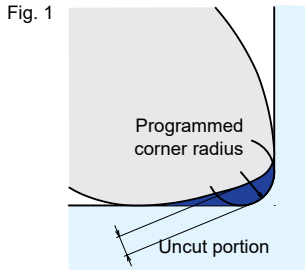

Programmed corner radius	Uncut portion	Overcut portion	Fig.
2,0	1,22	0	1
2,5	1,08	0	1
3,0	0,95	0	1
3,5	0,83	0,04	2

(mm)

## ■ Ramping/Helical Milling Upper Limit

Ramping

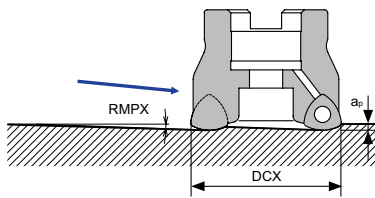

Helical Milling

≤ Min. diameter

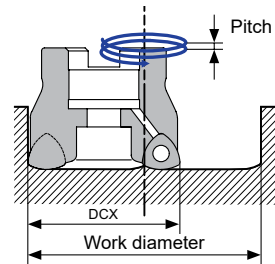

≥ Max. diameter

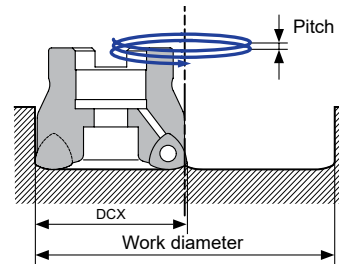

Below the min. machining diameter:  
Centre uncut portion cannot be removed by traverse cutting with the same cutter.

Above the max. machining diameter:  
Centre uncut portion can be removed by traverse cutting with the same cutter.

Max. dia. DCX (mm)	Ramping		Helical milling				
	Max. ramping angle RPMX (°)	Max. machining dia. (mm)	Max. pitch (mm/rev)	Standard diameter (mm)	Max. pitch (mm/rev)	Min. machining dia. (mm)	Max. pitch (mm/rev)
35	0,5	069,3	1,3	53,5	0,5	052,0	0,5
40	0,8	079,3	2,0	63,4	1,0	060,2	0,5
42	0,8	083,3	2,0	67,4	1,0	063,9	0,5
50	1,4	099,3	2,0	83,3	2,0	079,1	1,0
52	1,4	103,3	2,0	87,3	2,0	082,8	1,0
63	1,2	125,3	2,0	109,3	2,0	103,6	1,0
66	1,2	131,3	2,0	115,3	2,0	109,4	1,0
80	1,2	159,3	2,0	143,2	2,0	134,0	1,0
85	1,2	169,3	2,0	153,2	2,0	144,0	1,0
100	0,8	199,3	2,0	183,2	2,0	174,0	1,0
125	Not recommended						
160	Not recommended						

## ■ Plunge Cutting Upper Limit

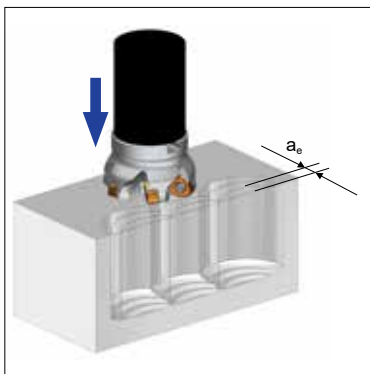

## ■ Recommended Cutting Conditions

ISO	Work material	Hardness	min.—optimum—max.	
			Cutting speed $v_c$ (m/min)	Feed rate $f_z$ (mm/t)
P	General steel	< 280 HB	100–160–250	1,0–1,5–2,0
	Alloy steel	< 280 HB	100–160–200	1,0–1,5–1,8
	Alloy steel	< 42 HRC	100–150–180	0,8–1,0–1,2
M	Stainless steel	–	80–120–150	0,8–1,0–1,2
K	Cast iron	–	100–160–250	1,0–1,5–1,8
H	Hardened steel	< 52 HRC	80–100–120	0,3–0,5–0,7

The above figures are guidelines for use with BT50 machine tools at depth of cut ( $a_e$ ) of 1,5 mm.

The above recommended cutting conditions may require adjustment depending on machine rigidity and workpiece rigidity.

Max. $a_e$ (mm)	Max. $f_z$ (mm/t)
10	0,2



# "Sumi Dual Mill" DMSW 08000 R(S)

**New**

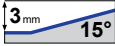
Rake angle	Radial	-7° to -10°	
	Axial	-6°	

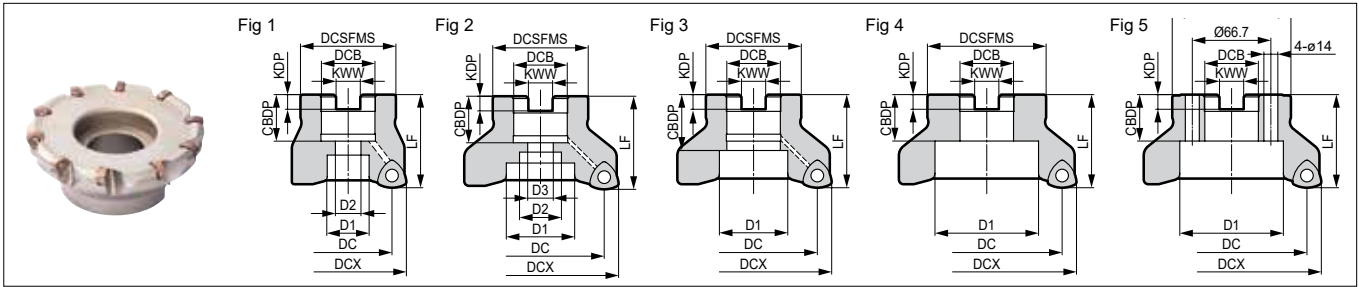





## Body (Shell Type)

													Dimensions (mm)			
Cat. No.	Stock	DCX	DC	DCSFMS	LF	DCB	KWW	KDP	CBDP	D1	D2	D3	Number of teeth	Weight (kg)	Fig.	
Metric	DMSW 08050RS04	●	50	33,4	41	40	22	10,4	6,3	20	16,7	11	-	4	0,25	1
	08050RS05	●	50	33,4	41	40	22	10,4	6,3	20	16,7	11	-	5	0,24	1
	08052RS04		52	35,4	41	40	22	10,4	6,3	20	17	11	-	4	0,27	1
	08052RS05		52	35,4	41	40	22	10,4	6,3	20	17	11	-	5	0,25	1
	08063RS04	●	63	46,4	50	40	22	10,4	6,3	20	18	11	-	4	0,46	1
	08063RS05	●	63	46,4	50	40	22	10,4	6,3	20	18	11	-	5	0,46	1
	08063RS06	●	63	46,4	50	40	22	10,4	6,3	20	18	11	-	6	0,44	1
	08063RS05-27	●	63	46,4	50	50	27	12,4	7	22	20	14	-	5	0,55	1
	08063RS06-27	●	63	46,4	50	50	27	12,4	7	22	20	14	-	6	0,53	1
	08066RS05-27		66	49,4	50	50	27	12,4	7	22	20	14	-	5	0,60	1
	08066RS06-27		66	49,4	50	50	27	12,4	7	22	20	14	-	6	0,58	1
	08080RS06	●	*80	63,3	55	50	27	12,4	7	22	20	14	-	6	0,88	1
	08080RS08	●	*80	63,3	55	50	27	12,4	7	22	20	14	-	8	0,84	1
	08100RS06	●	100	83,3	70	50	32	14,4	8	32	46	-	-	6	1,29	3
08125RS08	●	125	108,3	80	63	40	16,4	9	29	52	29	-	8	2,41	1	
08160RS10	●	160	143,3	130	63	40	16,4	9	29	90	-	-	10	4,73	5	
Inch	DMSW 08050R04	○	50	33,4	41	40	22,225	8,4	5	20	16,7	11	-	4	0,25	1
	08050R05	○	50	33,4	41	40	22,225	8,4	5	20	16,7	11	-	5	0,24	1
	08063R04	○	63	46,4	50	40	22,225	8,4	5	20	18	11	-	4	0,46	1
	08063R05	○	63	46,4	50	40	22,225	8,4	5	20	18	11	-	5	0,46	1
	08063R06	○	63	46,4	50	40	22,225	8,4	5	20	18	11	-	6	0,44	1
	08080R06	○	*80	63,3	70	63	31,75	12,7	8	32	27	18	-	6	1,32	1
	08080R08	○	*80	63,3	70	63	31,75	12,7	8	32	27	18	-	8	1,28	1
	08100R06	○	*100	83,3	70	63	31,75	12,7	8	32	46	27	18	6	1,75	2
	08125R08	○	125	108,3	80	63	38,1	15,9	10	35,5	55	30	-	8	2,55	1
	08160R10	○	160	143,3	100	63	50,8	19,1	11	38	72	-	-	10	4,18	4

Take note of the cutter mounting size (DCB) when selecting a cutter. Inserts are sold separately.

 For mounting the Ø 80 mm, Ø 85 mm and Ø 100 mm sized cutters marked with \* to an arbor, use a JIS B1176 hexagonal socket bolt (metric specification : M12x30 to 35 mm, inch specification: M16x40 to 45 mm).

## Parts

Applicable cutters	Insert screw		Wrench	Handle grip	Wrench bit
					
DMSW 08160R(S)10 Other than above	BFTX0513IP	5,0	TRDR20IP	-	-
			HPL2025	TRB20IP	

## Identification Details

<b>DMSW 08</b>	<b>063</b>	<b>R</b>	<b>S</b>	<b>05 - 27</b>
Cutter series	Insert size	Cutter diameter	Feed direction	Metric Number of teeth Mounting size

## Recommended Cutting Conditions

→ G.65

## Inserts



Application	Coated carbide					Dimension (mm)			
	ACU2500	ACP2000	ACP3000	ACK2000	ACK3000	IC	S	RE	Fig.
High speed / Light cut		P		K					
General purpose		P	P	K	K				
Roughing			P		K				
Cat. No.	ACU2500	ACP2000	ACP3000	ACK2000	ACK3000	IC	S	RE	Fig.
WNMU 0807ZNER-G	●	●	●	●	●	13	7	1,6	1
WNMU 0807ZNER-H	●	●	●	●	●	13	7	1,6	1

Fig 1



# "Metal Slash Mill" MSX Type

High Feed Milling of Steel, Stainless Steel, Die Steel and Cast Iron

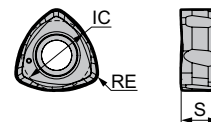

→ H10-13

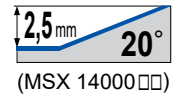
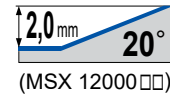
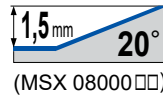

Fig. 1

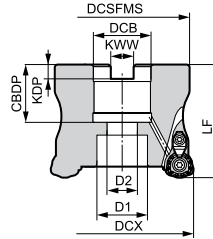
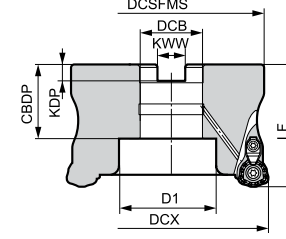

Fig. 2



## Body

Cat. No.	Stock	Dimensions (mm)									No. of teeth	Helical Boring øB <sub>(max-min)</sub>	Ramping α <sub>max.</sub>	Weight (Kg)	Fig.
		DCX	DCSFMS	LF	DCB	KWW	KDP	CBDP	D1	D2					
MSX 08040 RS	●	40	37	45	16	8,4	5,6	18	13,5	9	4	65-78	1°30'	0,2	1
MSX 12050 RS	●	50	47	50	22	10,4	6,3	20	18	11	4	78-99	2°30'	0,3	1
12052 RS	●	52	47	50	22	10,4	6,3	20	18	11	4	82-103	2°00'	0,3	1
12063 RS	●	63	60	50	22	10,4	6,3	20	18	11	5	104-125	1°30'	0,4	1
12066 RS	●	66	60	63	27	12,4	7,0	25	20	13,5	5	110-131	1°00'	0,4	1
MSX 14050 RS	●	50	47	50	22	10,4	6,3	20	17	11	3	73-98	3°30'	0,3	1
14063 RS	●	63	60	50	22	10,4	6,3	20	18	11	4	99-124	2°00'	0,6	1
14066 RS	●	66	60	63	27	12,4	7,0	25	13,5	20	4	107-132	2°00'	0,7	1
14080 RS	●	80	76	63	27	12,4	7,0	25	13,5	20	5	133-158	1°30'	1,2	1
MSX 14100 RS	●	100	96	63	32	14,4	8,5	32	-	44	6	173-198	1°00'	1,8	2

## Ramping (Slant Milling)

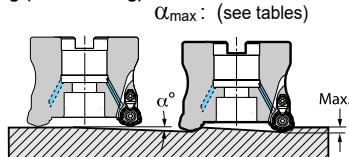

## Helical Boring

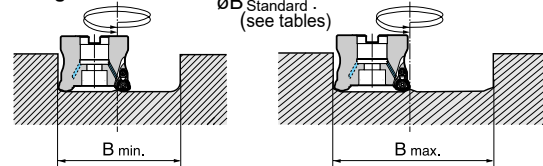

## Recommended Cutting Conditions

Depth of cut : a<sub>p</sub> (mm)  
Feed rate : f<sub>z</sub> (mm/tooth)

## Inserts

Application	Coated Carbide				Dimensions (mm)		
	ACP200	ACP300	ACK200	ACK300	IC	S	RE
High Speed / Light cut	●	●	●	●	8,5	4,0	2,0
General Purpose	●	●	●	●	12	5,0	2,0
Roughing	●	●	●	●	14	6,0	2,0
Cat. No.	ACP200	ACP300	ACK200	ACK300			
WDMT 0804 ZDTR	●	●	●	●			
0804 ZDTR-H	●	●	○	●			
WDMT 1205 ZDTR	●	●	●	●			
1205 ZDTR-H	●	●	○	●			
WDMT 1406 ZDTR	●	●	●	●			
1406 ZDTR-H	●	●	○	●			

ZDTR-H : Stronger cutting edge

Work Material	Insert Type	Cutting Speed v <sub>c</sub> (m/min)	Insert Cat. No.	ø 40		ø 50-66		ø 80-100	
				a <sub>p</sub>	f <sub>z</sub>	a <sub>p</sub>	f <sub>z</sub>	a <sub>p</sub>	f <sub>z</sub>
General Steel (Below HB200)	ACP200	100-150-200	WDMT 0804	1,0	1,2	-	-	-	-
			WDMT 1205	-	-	1,2	1,4	-	-
			WDMT 1406	-	-	1,5	1,5	1,5	1,5
Alloy Steel (Below HRC45)	ACP200	80-130-180	WDMT 0804	0,8	1,2	-	-	-	-
			WDMT 1205	-	-	1,0	1,4	-	-
			WDMT 1406	-	-	1,3	1,5	1,3	1,5
Stainless Steel (X5CRN11810)	ACP300	80-120-150	WDMT 0804	1,0	0,8	-	-	-	-
			WDMT 1205	-	-	1,2	1,2	-	-
			WDMT 1406	-	-	1,5	1,3	1,5	1,3
Cast Iron GG, GGG	ACK300	100-150-200	WDMT 0804	1,0	1,4	-	-	-	-
			WDMT 1205	-	-	1,2	1,5	-	-
			WDMT 1406	-	-	1,5	1,8	1,5	1,8
Hardened Steel (Below HRC50)	ACK300	40-80-100	WDMT 0804	0,5	0,8	-	-	-	-
			WDMT 1205	-	-	0,6	1,0	-	-
			WDMT 1406	-	-	1,0	1,2	1,0	1,2

- The above recommended cutting conditions may require adjustment according to machine rigidity and work rigidity.
- The above figures are guidelines for use with the BT50 machine tool.

## Spare Parts

Screw	Wrench	Clamp	C Ring	Cramp screw	Applicable endmill
BFTX 0306 IP 2,0	TRDR 08 IP	CCH 3,5	CR 03	BFTX 03510 IP 08	MSX 08000RS
BFTX 0409 IP 3,0	TRDR 15 IP	CCH 3,5	CR 03	BFTX 03510 IP 15	MSX 12000RS
BFTX 0511 IP 5,0	TRDR 20 IP	CCH 4,5	CR 03	BFTX 04513 IP 20	MSX 14000RS

Remark: If depth-of-cut exceeds 5 mm, reduce recommended feedrates by 50 %.

The conditions above are meant as a guide, please adjust the cutting conditions according to actual work material and machine rigidity.

# "Wave Mill" Series

## WFXH Type



### General Features

WaveMill WFXH type is a high efficiency, multi-purpose cutter, that uses the WFX series inserts for high-feed roughing and a variety of processes.

### Characteristics

Stable, high-efficiency milling with superior cutting edge sharpness. Supports various types of processes (ramping and helical milling). Able to use the selection of inserts from the WFX series.

### Chipbreaker Selection

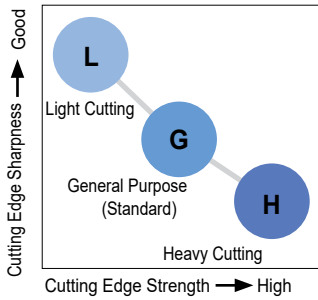

Work Material	P M K	Steel, Stainless Steel, Cast Iron			N	Aluminium Alloy
Breaker	L Type	G Type	H Type	S Type		
Characteristic	Low Cutting Force	General Purpose	Strong Edge	Sharp Edge		
Cutting Edge Figure						
Work Material Application	Light Cutting Low rigidity Milling Low-Burr Design	<b>Main Chipbreaker</b> General to Interrupted Milling	Heavy Cut Heavy Interrupted Machining Tempered Steel	Non-Ferrous Metal		

### Notes on Corner Finishing - Remaining Material

Actual machined corners will have uncut and overcut portions due to the shape of the inserts.

Fig. 1

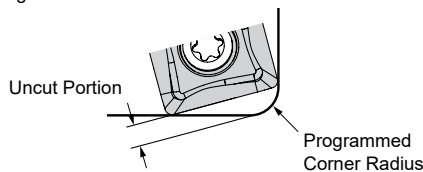
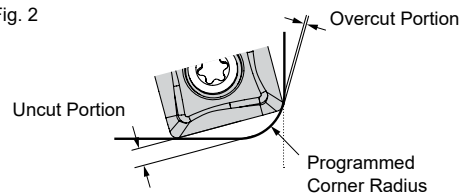

Fig. 2



### WFXH 08000 RS Type

Programmed Corner R	SOMT 080004-□			SOMT 080008-□			SOMT 080012-□		
	Uncut Portion	Overcut Portion	Shape	Uncut Portion	Overcut Portion	Shape	Uncut Portion	Overcut Portion	Shape
2,0	1,41	0	Fig. 1	1,30	0	Fig. 1	1,21	0	Fig. 1
2,5	1,30	0,02	Fig. 2	1,19	0,01	Fig. 2	1,09	0	Fig. 2
3,0	-	-	-	-	-	-	0,98	0,05	Fig. 2

### WFXH 12000 RS Type

Programmed Corner R	SOMT 120004-□			SOMT 120008-□			SOMT 120012-□			SOMT 120016-□		
	Uncut Portion	Overcut Portion	Shape	Uncut Portion	Overcut Portion	Shape	Uncut Portion	Overcut Portion	Shape	Uncut Portion	Overcut Portion	Shape
2,0	2,58	0	Fig. 1	2,48	0	Fig. 1	2,37	0	Fig. 1	2,25	0	Fig. 1
2,5	2,47	0	Fig. 1	2,37	0	Fig. 1	2,25	0	Fig. 1	2,14	0	Fig. 1
3,0	2,36	0	Fig. 1	2,26	0	Fig. 1	2,14	0	Fig. 1	2,11	0	Fig. 1
3,5	2,24	0,01	Fig. 2	2,14	0	Fig. 1	2,03	0	Fig. 1	1,91	0	Fig. 1
4,0	-	-	-	2,03	0,04	Fig. 2	1,91	0,03	Fig. 2	1,8	0,01	Fig. 2

### Minimum Cutting Diameter

Minimum cutting diameter (DCN) will depend on the insert that is used. Using an insert with a large nose radius is recommended for the WFXH type.

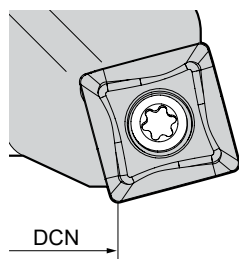
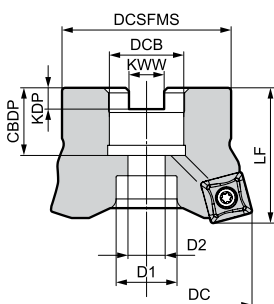

Body Cat. No.	DC	DCN based on insert nose			
		RE0,4	RE0,8	RE1,2	RE1,6
WFXH 08025 M1Z22	25	10,4	10,9	11,5	-
08032 M1Z23	32	17,4	17,9	18,5	-
WFXH 08040 RS	40	25,4	25,9	26,5	-
08050 RS	50	35,4	35,9	36,5	-
08050 RSZ6	50	35,4	35,9	36,5	-
08063 RS	63	48,4	48,9	49,5	-
WFXH 12040 M1Z23	40	16,6	17,1	17,5	18,1
WFXH 12050 RS	50	26,6	27,2	27,7	28,2
12063 RS	63	39,5	40,0	40,4	41,1

## ■ Taper Cutting and Helical Milling

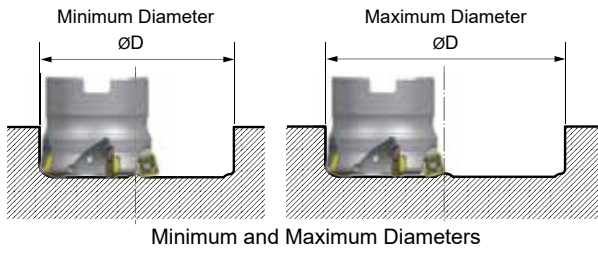

Insert Cat. No.	DC	Helical Milling		Taper Cutting
		Min.	Max.	Max. Ramping Angle
SOMT 080004-□	25	35	49	1°30'
	32	49	63	0°30'
	40	65	79	0°30'
	50	Impossible	Impossible	0°30'
	63	Impossible	Impossible	Impossible
SOMT 080008-□	25	35	48	3°
	32	49	62	1°30'
	40	65	78	1°
	50	85	98	0°30'
	63	111	124	0°30'
SOMT 080012-□	25	34	47	4°30'
	32	48	61	2°30'
	40	64	77	1°30'
	50	84	97	1°
	63	110	123	0°30'

Insert Cat. No.	DC	Helical Milling		Taper Cutting
		Min.	Max.	Max. Ramping Angle
SOMT 120004-□	40	56	79	1°
	50	76	99	0°30'
	63	Impossible	Impossible	Impossible
SOMT 120008-□	40	56	78	1°30'
	50	76	98	1°
	63	102	124	0°30'
SOMT 120012-□	40	55	77	2°30'
	50	75	97	1°30'
	63	101	123	1°
SOMT 120016-□	40	55	76	3°30'
	50	75	96	2°
	63	101	122	1°30'

## ■ Maximum Width of Cut when Plunge Milling

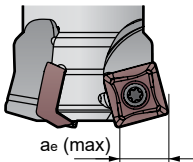

Insert Cat. No.	Max. Width of Cut ae (max)
SOMT08	6 mm
SOMT12	10 mm

Lower the feed rate when plunge milling.

## ■ Recommended Cutting Conditions

ISO	Work Material	Grade	Cutting Speed (vc (m/min))	Insert Cat. No.	ø 25		ø 32		ø 40		ø 50		ø 63	
					ap (mm)	fz (mm/t)	ap (mm)	fz (mm/t)	ap (mm)	fz (mm/t)	ap (mm)	fz (mm/t)	ap (mm)	fz (mm/t)
P	General Steel <200HB	ACP200	100 - 150 - 200	SOMT08	0,8	0,8	0,8	0,8	-	-	0,8	0,8	0,8	0,8
				SOMT12	-	-	-	-	1,0	1,0	1,0	1,0	1,0	1,0
P	Alloy Steel <HRC45	ACP200	80 - 130 - 180	SOMT08	0,7	0,8	0,7	0,8	-	-	0,7	0,8	0,7	0,8
				SOMT12	-	-	-	-	0,8	1,0	0,8	1,0	0,8	1,0
K	Stainless Steel (X5CrNiS18 10, other)	ACM300	80 - 120 - 150	SOMT08	0,8	0,7	0,8	0,7	-	-	0,8	0,7	0,8	0,7
				SOMT12	-	-	-	-	1,0	0,8	1,0	0,8	1,0	0,8
M	Cast Iron FC, FCD	ACK300	100 - 150 - 200	SOMT08	0,8	1,0	0,8	1,0	-	-	0,8	1,0	0,8	1,0
				SOMT12	-	-	-	-	1,0	1,2	1,0	1,2	1,0	1,2
H	Hardened Steel <HRC50	ACK300	40 - 80 - 100	SOMT08	0,5	0,5	0,5	0,5	-	-	0,5	0,5	0,5	0,5
				SOMT12	-	-	-	-	0,6	0,8	0,6	0,8	0,6	0,8

The above recommended cutting conditions may require adjustment according to machine rigidity and work rigidity. The above figures are guidelines for use with the BT50 machine tool.

The above conditions assume a tool overhang length of L/D = 3 (i.e. overhang length is 3 times tool diameter) or less.

When tool overhang is more than L/D = 3 and less or equal L/D = 5, settings should be adjusted to approximately 70 % to 80 % of those indicated in the above cutting conditions (i.e. ap and fz).

When tool overhang is more than L/D = 5 and less or equal L/D = 8, settings should be adjusted to approximately 50 % to 60 % of those indicated in the above cutting conditions (i.e. ap and fz).



High Efficiency Machining for Steel, Stainless Steel, Die Steel and Non-Ferrous Metal

Rake Angle	Radial	-6°	1,5 mm 15°
	Axial	6°	

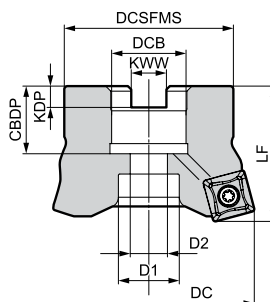

## Body - WFXH08000RS

Cat. No.	Stock	Dimensions (mm)										No. of Teeth	Weight (kg)
		DC	DCSFMS	LF	DCB	KWW	KDP	CBDP	D1	D2			
WFXH 08040 RS	○	40	33	40	16	8,4	5,6	18	14	9	4	0,2	
08050 RS	○	50	41	40	22	10,4	6,3	20	18	11	5	0,3	
08050 RSZ6	○	50	41	40	22	10,4	6,3	20	18	11	6	0,3	
08063 RS	○	63	50	40	22	10,4	6,3	20	18	11	6	0,5	

→ H15

Inserts are not included.

## Identification Details

<b>WFX</b>	<b>H</b>	<b>08</b>	<b>040</b>	<b>R</b>	<b>S</b>	<b>- Z6</b>
Cutter Series	High Efficiency Milling	Insert Size	Cutter Diameter	Direction	Metric Type	Fine Pitch Type (Value is number of teeth)

## Inserts

Dimensions (mm)

Application	Coated Carbide										Carbide	DLC	Cermet	RE
	P	K	M	P	M	P	M	P	M	K	N	N	P	
High Speed / Light cut	●	●	●	●	●	●	●	●	●	●	●	●	●	
General Purpose	●	●	●	●	●	●	●	●	●	●	●	●	●	
Roughing	●	●	●	●	●	●	●	●	●	●	●	●	●	
Cat. No.	ACU2500	XCU2500	ACP100	ACP200	ACP300	XCU2000	ACK200	ACK300	ACM200	ACM300	H1	DL1000	T4500A	
SOMT 080304 PZER L	●	○	●	●	○	○	○	●	●	●	-	-	-	0,4
SOMT 080308 PZER L	●	○	○	●	●	○	○	●	●	●	-	-	-	0,8
SOMT 080304 PZER G	●	○	●	●	●	○	○	●	●	●	-	-	-	0,4
SOMT 080308 PZER G	●	○	●	●	●	○	○	●	●	●	-	-	-	0,8
SOMT 080312 PZER G	●	○	●	●	●	○	○	●	●	●	-	-	-	1,2
SOMT 080308 PZER H	●	○	●	●	●	○	○	●	●	●	-	-	-	0,8
SOMT 080312 PZER H	●	○	●	●	●	○	○	●	●	●	-	-	-	1,2
SOET 080304 PZER G	●	○	○	○	○	○	○	○	○	○	-	-	○	0,4
SOET 080308 PZER G	●	○	○	○	○	○	○	○	○	○	-	-	○	0,8
SOET 080312 PZER G	●	○	○	○	○	○	○	○	○	○	-	-	○	1,2
SOET 080302 PZFR S*	-	-	-	-	-	-	-	-	-	-	●	●	-	0,2
SOET 080304 PZFR S*	-	-	-	-	-	-	-	-	-	-	●	●	-	0,4
SOET 080308 PZFR S*	-	-	-	-	-	-	-	-	-	-	●	●	-	0,8

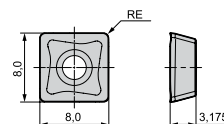

\* If the cutting edge lacks strength when performing high efficiency milling of non-ferrous metals, try G type chipbreakers (ACK300).

## Spare Parts

Screw	Wrench
BFTX0306IP	TRDR08IP
2,0	

## Recommended Cutting Conditions

→ G69

## Programming and Dimension Information

→ G68

Expansion

# "Wave Mill" Series WFXH 12000 RS

High Efficiency Machining for Steel, Stainless Steel, Die Steel and Non-Ferrous Metal

Rake Angle	Radial	-6°	2,5 mm 15°
	Axial	6°	

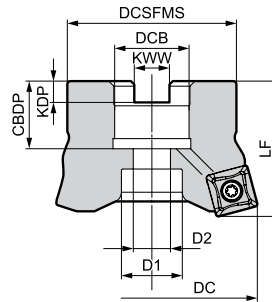

## ■ Body - WFXH12000RS

Cat. No.	Stock	Dimensions (mm)										No. of Teeth	Weight (kg)
		DC	DCSFMS	LF	DCB	KWW	KDP	CBDP	D1	D2			
WFXH 12050 RS	○	50	41	40	22	10,4	6,3	20	18	11	4	0,3	
12063 RS	○	63	50	40	22	10,4	6,3	20	18	11	5	0,4	

Inserts are not included.

→ H15

## ■ Identification Details

<b>WFX</b>	<b>H</b>	<b>12</b>	<b>050</b>	<b>R</b>	<b>S</b>
Cutter Series	High Efficiency Milling	Insert Size	Cutter Diameter	Direction	Metric Type

## ■ Inserts

Application	Coated Carbide										Carbide	DLC	Cermet	RE
	M	P	P	P	P	K	K	M	M	M	K	N	P	
High Speed / Light cut	●	●	●	●	●	●	●	●	●	●	●	●	●	
General Purpose	●	●	●	●	●	●	●	●	●	●	●	●	●	
Roughing	●	●	●	●	●	●	●	●	●	●	●	●	●	
Cat. No.	ACU2500	XCU2500	ACP100	ACP200	ACP300	XCU2000	ACK200	ACK300	ACM200	ACM300	H1	DL1000	T4500A	
SOMT 120408 PDER L	●	○	●	●	●	○	●	●	●	●	-	-	-	
SOMT 120404 PDER G	●	○	○	●	●	○	●	●	●	●	-	-	-	
120408 PDER G	●	○	○	●	●	○	●	●	●	●	-	-	○	
120412 PDER G	●	○	○	●	●	○	●	○	○	●	-	-	-	
120416 PDER G	●	○	○	●	●	○	○	○	○	●	-	-	-	
SOMT 120408 PDER H	●	○	●	●	●	○	●	●	●	●	-	-	-	
SOET 120408 PDFR S*	-	-	-	-	-	-	-	-	-	-	●	●	-	

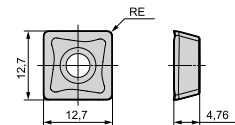

\* If the cutting edge lacks strength when performing high efficiency milling of non-ferrous metals, try G type chipbreakers (ACK300).

## ■ Spare Parts

Screw	Wrench
BFTX03512IP	3,0 TRDR15IP

## ■ Recommended Cutting Conditions

→ G69

## ■ Programming and Dimension Information

→ G68

Milling Cutters



# "Wavemill" Series WAX 3000 RS

16-18mm 90°



(Shellmill)

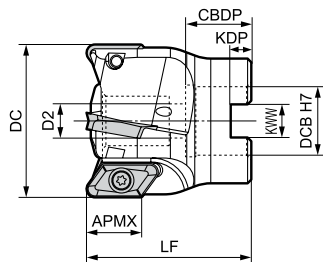

## ■ Body (For inserts with nose radius ≤ 3,2 mm)

Cat. No.	Stock	Dimensions (mm)							No. of teeth	Weight (Kg)
		DC	DCB	LF	D2	KWW	KDP	CBDP		
WAX 3050 RS-3.2	●	50	22	50	11	10,4	6.3	21	4	0,34
3063 RS-3.2	●	63	22	50	11	10,4	6.3	21	5	0,6
3080 RS-3.2	●	80	27	50	13,5	12,4	7	23	5	1,0
WAX 3100 RS-3.2	●	100	32	63	18	14,4	8	26	6	2,2
3125 RS-3.2	●	125	40	63	22	16,4	9	29	7	3,5

## ■ Body (For inserts with nose radius ≥ 4,0mm)

Cat. No.	Stock	Dimensions (mm)							No. of teeth	Weight (Kg)
		DC	DCB	LF	D2	KWW	KDP	CBDP		
WAX 3050 RS-4.0	●	50	22	50	11	10,4	6.3	21	4	0,34
3063 RS-4.0	●	63	22	50	11	10,4	6.3	21	4	0,6
3080 RS-4.0	●	80	27	50	13,5	12,4	7	23	5	1,0
WAX 3100 RS-4.0	○	100	32	63	18	14,4	8	26	6	2,2
3125 RS-4.0	●	125	40	63	22	16,4	9	29	7	3,5

## ■ Inserts for WAX 3000 Type

Application	DLC Coated	Carbide	Dimensions (mm)						
High Speed / Light cut									
General Purpose									
Roughing									
Cat. No.	DL1000	H1	Dimensions (mm)						D1
			APMX	INSL	BS	RE	S		
AECT 160404 PEFRA	●	●	18	16,4	1,4	0,4	5	4,4	
160408 PEFRA	●	●	18	16,4	1,0	0,8	5	4,4	
160412 PEFRA	●	●	18	16,4	0,6	1,2	5	4,4	
160416 PEFRA	●	●	17,5	16,4	0,5	1,6	5	4,4	
160420 PEFRA	●	●	17,5	16,4	0,5	2,0	5	4,4	
160430 PEFRA	●	●	17	16,4	0,7	3,0	5	4,4	
160432 PEFRA	●	●	17	16,4	0,5	3,2	5	4,4	
AECT 160440 PRFRA	●	●	16,5	16,4	0,5	4,0	5	4,4	
160450 PEFRA	●	●	16	16,4	0,4	5,0	5	4,4	

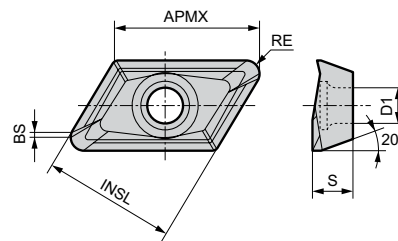

## ■ Spare Parts

Screw	Insert Wrench	Applicable Endmill
3,0 (N·m)		
BFTX 0408	TRD 15	Ø 50 – Ø 125

# "Wavemill" Series WAX 4000 RS

22-24mm 90°

## (Shellmill)

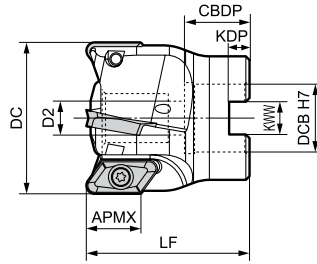

## ■ Body

(For inserts with nose radius  $\leq 3,2$  mm)

Cat. No.	Stock	Dimensions (mm)							No. of teeth	Weight (Kg)
		DC	DCB	LF	D2	KWW	KDP	CBDP		
WAX 4050RS-3.2	<input type="checkbox"/>	50	16	50	9	8,4	5,6	18	2	0,37
4063RS-3.2	<input type="checkbox"/>	63	22	50	11	10,4	6,3	21	3	0,54
4080RS-3.2	<input type="checkbox"/>	80	27	50	13,5	12,4	7	23	4	0,81
WAX 4100RS-3.2	<input type="checkbox"/>	100	32	63	18	14,4	8	26	5	1,7
4125RS-3.2	<input type="checkbox"/>	125	40	63	22	16,4	9	29	6	2,6

## ■ Body

(For inserts with nose radius  $\geq 4,0$  mm)

Cat. No.	Stock	Dimensions (mm)							No. of teeth	Weight (Kg)
		DC	DCB	LF	D2	KWW	KDP	CBDP		
WAX 4050RS-4.0	<input type="checkbox"/>	50	16	50	9	8,4	5,6	18	2	0,37
4063RS-4.0	<input type="checkbox"/>	63	22	50	11	10,4	6,3	21	3	0,54
4080RS-4.0	<input type="checkbox"/>	80	27	50	13,5	12,4	7	23	4	0,81
WAX 4100RS-4.0	<input type="checkbox"/>	100	32	63	18	14,4	8	26	5	1,7
4125RS-4.0	<input type="checkbox"/>	125	40	63	22	16,4	9	29	6	2,6

## ■ Inserts for WAX 4000 Type

Application	DLC Coated	Carbide	Dimensions (mm)						
High Speed / Light cut	<input checked="" type="checkbox"/>	<input checked="" type="checkbox"/>							
General Purpose	<input type="checkbox"/>	<input checked="" type="checkbox"/>							
Roughing	<input type="checkbox"/>	<input type="checkbox"/>							
Cat. No.	DL1000	H1	Dimensions (mm)						
			APMX	INSL	BS	RE	S	D1	
AECT 220604 PEFRA	<input type="checkbox"/>	<input type="checkbox"/>	24	21,8	1,5	0,4	6,35	6	
220608 PEFRA	<input type="checkbox"/>	<input type="checkbox"/>	24	21,8	1,2	0,8	6,35	6	
220612 PEFRA	<input type="checkbox"/>	<input type="checkbox"/>	24	21,8	0,8	1,2	6,35	6	
220616 PEFRA	<input type="checkbox"/>	<input type="checkbox"/>	24	21,8	0,4	1,6	6,35	6	
220620 PEFRA	<input type="checkbox"/>	<input type="checkbox"/>	24	21,8	0,5	2,0	6,35	6	
220630 PEFRA	<input type="checkbox"/>	<input type="checkbox"/>	23	21,8	0,6	3,0	6,35	6	
220632 PEFRA	<input type="checkbox"/>	<input type="checkbox"/>	23	21,8	0,4	3,2	6,35	6	
AECT 220640 PRFRA	<input type="checkbox"/>	<input type="checkbox"/>	22	21,8	1,2	4,0	6,35	6	
220650 PEFRA	<input type="checkbox"/>	<input type="checkbox"/>	22	21,8	0,4	5,0	6,35	6	

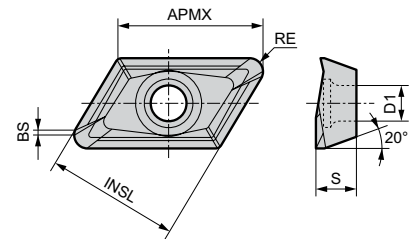

## ■ Spare Parts

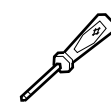
Screw	Insert Wrench	Applicable Endmill
		
BFTX0511N	TRD20	Ø 50 – Ø 125



## ■ Features

- **Drastically Reduced Runout Adjustment Time**  
Simple screw-fastening structure enables fine adjustments to be made easily.
- **Blade Through Coolant**  
Secures a supply of coolant to the cutting edge and breaks chips thoroughly.
- **Lightweight Aluminum Alloy Body**  
Utilizing aluminum alloy to achieve a total weight of less than 1,3 kg for a Ø 125 mm cutter with 22 teeth.

## ■ Product Range

Type	Cat. No.	Body Material	Diameter Range (mm) / No of Teeth										
			Ø 25	Ø 30	Ø 32	Ø 40	Ø 50	Ø 63	Ø 80	Ø 100	Ø 125	Ø 160	
Shell	ANXA 16000RS	Aluminum Alloy								6, 10, 14	8, 12, 18	10, 14, 22	12, 20, 28
	ANXA 16000R (Inch)	Aluminum Alloy								6, 10, 14	8, 12, 18	10, 14, 22	12, 20, 28
	ANXS 16000RS	Steel				4, 6	4, 6, 9	6, 8, 12	6, 10, 14	8, 12, 18	10, 14, 22		
	ANXS 16000R (Inch)	Steel						6, 8, 12	6, 10, 14	8, 12, 18	10, 14, 22		
Shank	ANXS 16000E	Steel	2	3, 4	3, 4	4, 6	4, 6, 9	→ H84					
Modular	ANXS 16000M	Steel	2	3, 4	3, 4	4, 6		→ H86					

→ M58-M69

Inch Bore

## ■ Blade Selection Guide

Work Material	N								
Applications	Finishing / Light Cutting	General Purpose	Roughing		Combined Milling *1	Corner Radius Milling	Corner Radius Milling	Finishing	Burr-free / Mirror Finishing
Features	Low Cutting Force	Standard	Long Edge	High Strength	High Strength	Corner Radius 0,4	Corner Radius 0,8	Wiper	Wiper
Type	<b>L</b>	<b>G</b>	<b>GX</b>	<b>H</b>	<b>GB</b>	-	-	<b>W</b>	<b>WS</b>
Cutting Edge Shape									
Edge Length(*2)	6,0 mm	6,0 mm	9,0 mm	6,0 mm	6,0 mm	6,0 mm	6,0 mm	2,0 mm	-

\*1 Machining of components combining aluminum alloy and cast iron

## ■ Edge Selection Guide

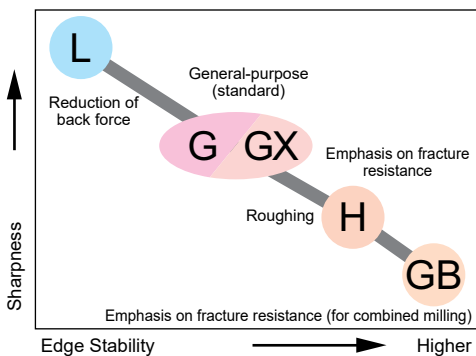

\*2 Edge length  
GX type = 9,0 mm

- **Reduces Running Costs by Drastically Increasing Blade, Insert Regrinding Allowance (to 1,0 mm)**

Assuming 0,2 mm of regrinding each time, an edge can be used up to 6 times. (Peripheral edge cannot be reground.)

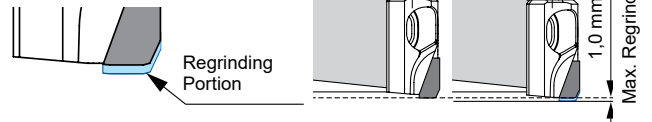

If you wish to use reground blades you shall use sets of blades with matching size of the same level in order to keep the balance.

## ■ Performances

### ● High-Speed / High-Efficiency Cutting

Realizes ultra-high efficiency machining with  $v_f = 30.000$  mm/min



Comparison: Cutter Diameter  $\varnothing$  100 mm

	Spindle Speed min <sup>-1</sup>	Number of Teeth	Feed Rate $v_f$ (mm/min)
ANX Series	18.000	18	32.400
Competitor	9.500	12	11.400

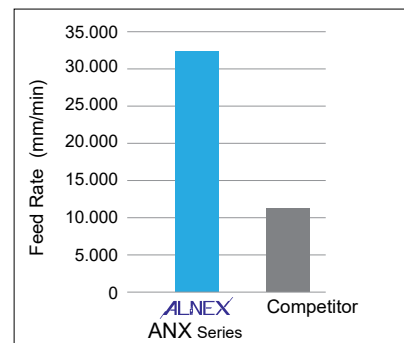

### ● Drastically Reduces Runout Adjustment Time

- Simple screw-fastening structure
- Enables fine adjustments to be made easily
- High-rigidity body

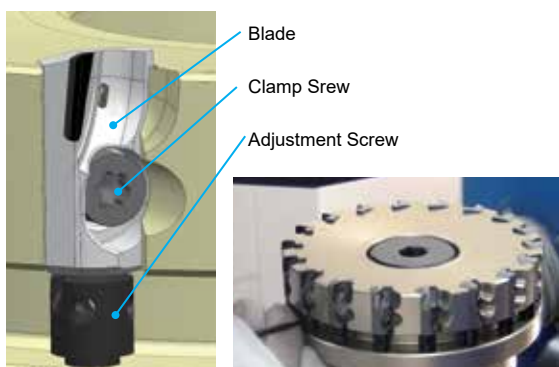

### Adjustment Time for Runout Setting $\leq 5 \mu\text{m}$

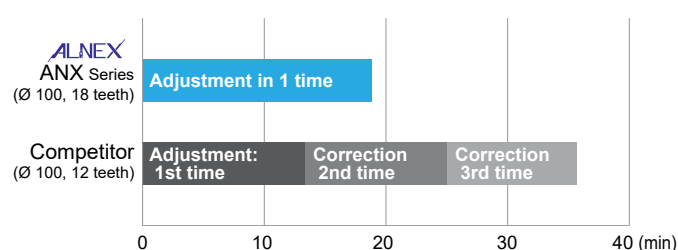

Already completed in 1st time setting, adjustment time reduced.

### ● Chip Control

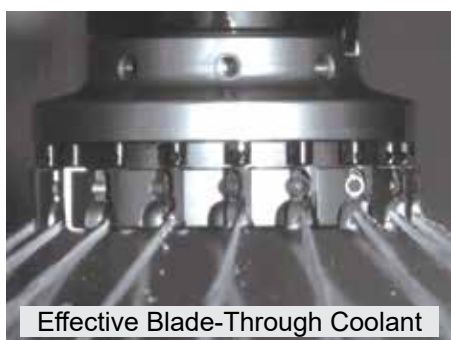

### Blade-Through Coolant Chip Breaking



ALNEX ANX Series

Competitor

Work Material: G-AlSi12Cu  
Cutting Conditions:  $v_c = 2500$  m/min,  $f_z = 0,05$  mm/t,  $a_p = 0,5$  mm, wet

## ■ Adjustment of the Blades, Runout Alignment

- Insert the blade into its seat.
- While holding the blade against the seat, install the clamping bolt using the provided wrench, pre-tightening the bolt. (recommended pre-torque is 1 N·m)
- Using the provided wrench for the height adjustment screw, set the height to your predetermined value.
- Fully tighten the clamp bolt. (recommended torque is 2 N·m)



## ■ CVD Single Crystal Diamond SCV10 Wiper Blade

Wiper blade adopts high-strength single-crystal diamond using Sumitomo Electric Hardmetal's vapour phase synthesis technology.

Sharp cutting edge realises burr-free, mirror finish surface quality in aluminum alloy machining.

Superior wear resistance maintains cutting edge sharpness for a long time, reducing total tool costs.

## ■ Burr-free

Sharp cutting edge and excellent wear resistance suppress burrs over the long term.

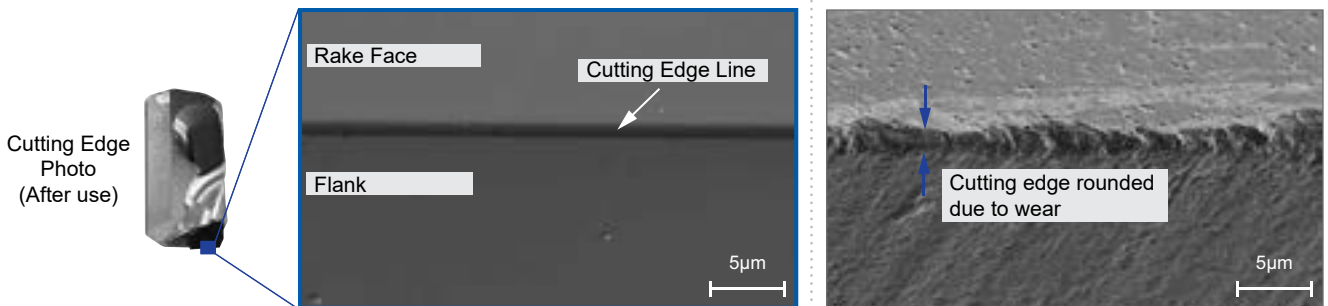
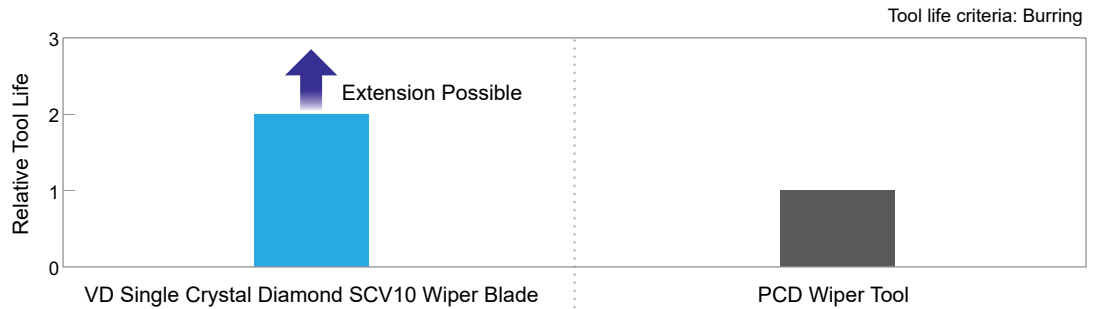

## ■ Mirror Finishing

Sharp cutting edge achieves mirror finish with cutting alone.

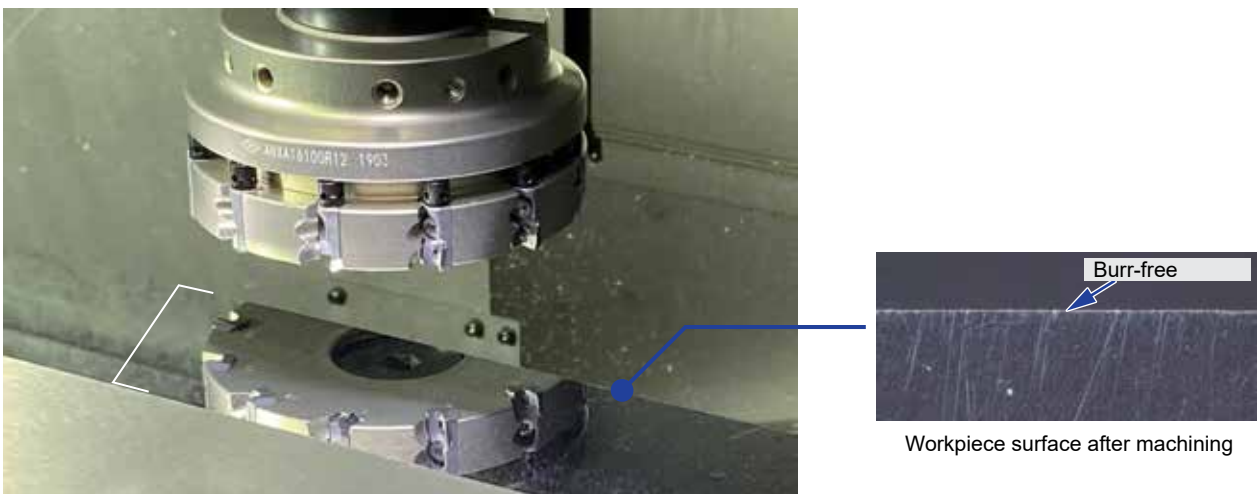



## ■ Polycrystalline Diamond SUMIDIA DA1000 / DA90

Through the ideal combination of diamond particle size and binder, SUMIDIA DA1000/DA90 possess various features and is suitable for all kinds of applications such as machining of aluminum alloy and cemented carbide.

## ■ Grades, Features and Applications

Grade	Features	Applications	Diamond share (%)	Average grain size of diamond particles (μm)	Hardness HK (GPa)	TRS (GPa)
DA1000	High-density sintered grade made of ultra-fine grain diamond that exhibits excellent wear and fracture resistance as well as edge sharpness.	Machining of High-Silicon Aluminum Alloy, Rough, Interrupt and Finish Machining of Aluminum Alloy, Woodcraft or Wooden Board Cutting/Facing, General Finishing of Non-Ferrous Metals	90–95	≤ 0,5	50–60	≈ 2,60
DA90	Contains coarser diamond particles than other grades, giving it good wear resistance suitable for the machining of carbides and high-silicon aluminum. Shows the highest diamond content for excellent wear resistance.	Machining of High-Silicon Aluminum Alloy, Machining of Aluminum Composite (MMC), Green or Semi-Sintered Cemented Carbide & Ceramic Roughing, Machining of Sintered Ceramic/Stone/Rock	90–95	≤ 50	50–65	≈ 1,10

## ■ Grade Applications

	Work Material	Applicable Grade	Example Parts
Aluminum	Sintered Aluminum, Wrought Aluminum Alloy	DA1000	Piston Liners, Machine Parts, etc.
	Alloys for Die Casting		Transmission Case, Oil Pan, Cylinder Block
	Alloys for Casting Low Si (≤ 12%)		Cylinder Head
	Alloys for Casting High Si (> 12%)		Cylinder Block
Non-ferrous metal	Non-Ferrous Sintered Alloy	DA1000	Bush
	Gunmetal, Carbon		Connecting Rod
	Fe Combined	DA90	Cylinder Block, Bearing Cap



# Alnex ANXA 16000 R(S)

Expansion

Rake Angle	Radial	+5°	3 mm	90°
	Axial	+5°		

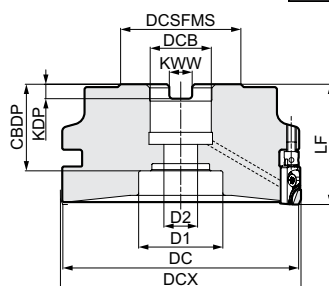

## Body - ANXA (Aluminum Alloy)

Dimensions (mm)

	Cat. No.	Stock	DC	DCX	DCSFMS	LF	DCB	KWW	KDP	CBDP	D1	D2	No. of Teeth	Weight (kg)
Metric	ANXA 16080RS06	○	78	80	50	50	27	12,4	7	34	35	14	6	0,5
	16080RS10	●	78	80	50	50	27	12,4	7	34	35	14	10	0,5
	16080RS14	●	78	80	50	50	27	12,4	7	34	35	14	14	0,5
	16100RS08	○	98	100	50	59	27	12,4	7	34	35	14	8	0,8
	16100RS12	●	98	100	50	50	27	12,4	7	34	35	14	12	0,8
	16100RS18	●	98	100	50	50	27	12,4	7	34	35	14	18	0,9
	16125RS10	○	123	125	50	50	27	12,4	7	34	35	14	10	1,2
	16125RS14	●	123	125	50	50	27	12,4	7	34	35	14	14	1,2
	16125RS22	●	123	125	50	50	27	12,4	7	34	35	14	22	1,3
	16160RS12	○	158	160	80	63	40	16,4	9	35	52	29	12	2,6
	16160RS20	○	158	160	80	63	40	16,4	9	35	52	29	20	2,6
16160RS28	○	158	160	80	63	40	16,4	9	35	52	29	28	2,6	
Inch	ANXA 16080R06	○	78	80	50	50	25,4	9,5	6	34	35	14	6	0,5
	16080R10	○	78	80	50	50	25,4	9,5	6	34	35	14	10	0,5
	16080R14	○	78	80	50	50	25,4	9,5	6	34	35	14	14	0,5
	16100R08	○	98	100	50	50	25,4	9,5	6	34	35	14	8	0,8
	16100R12	○	98	100	50	50	25,4	9,5	6	34	35	14	12	0,9
	16100R18	○	98	100	50	50	25,4	9,5	6	34	35	14	18	0,9
	16125R10	○	123	125	50	50	25,4	9,5	6	34	35	14	10	1,2
	16125R14	○	123	125	50	50	25,4	9,5	6	34	35	14	14	1,2
	16125R22	○	123	125	50	50	25,4	9,5	6	34	35	14	22	1,3
	16160R12	○	158	160	80	63	38,1	15,9	10	42,5	55	30	12	2,3
	16160R20	○	158	160	80	63	38,1	15,9	10	42,5	55	30	20	2,4
16160R28	○	158	160	80	63	38,1	15,9	10	42,5	55	30	28	2,6	

Blades are sold separately. If using a blade for corner radius machining (ANB1604R/ANB1608R), DC = DCX.

The weight includes the weight of the blade and parts (excluding the centre bolt).

All aluminium alloy bodies with a maximum blade diameter (DCX) of Ø 80 to Ø 125 have the same diameter (DCB) of the retainer hole (metric Ø 27/in Ø 25,4).

## Identification Details

<b>ANX</b>	<b>A</b>	<b>16</b>	<b>100</b>	<b>R</b>	<b>S</b>	<b>18</b>
Cutter Series	Aluminum Alloy Body	Blade Size	Cutter Diameter	Feed Direction	Metric	Number of Teeth

● = Euro stock  
○ = Japan stock

□ = Delivery on request

Recommended Tightening Torque (N·m)



## Blades

Dimensions (mm)

Application	SUMIDIA	CVD						
High Speed / Light Cut	<b>N</b>	<b>N</b>	<b>N</b>					
General Purpose	<b>N</b>	<b>N</b>	<b>N</b>					
Roughing	<b>N</b>	<b>N</b>	<b>N</b>					
Cat. No.	DA1000	DA90	SCV10	Cutting Edge Length	RE	Wiper Edge Shape	Applications	Fig.
ANB 1600R-L	●	—	—	6,0	—	Linear	Low Cutting Force	1
1600R-G	●	—	—	6,0	—	Arc-Shaped	General Purpose	1
1600R-GB	●	●	—	6,0	—	Arc-Shaped	Combined Milling*	1
1600R-H	●	—	—	6,0	—	Arc-Shaped	Strong Edge	1
1600R-GX	○	—	—	9,0	—	Arc-Shaped	Long Edge	2
1604R	○	—	—	6,0	0,4	Linear	Corner Radius	3
1608R	○	—	—	6,0	0,8	Linear	Corner Radius	3
1600R-W	○	—	—	2,0	—	Arc-Shaped	Wiper	4
1600R-WS	—	—	□	—	—	Arc-Shaped	Wiper	5

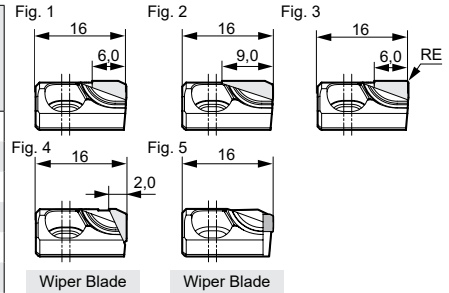

\* Cast Iron/Aluminum Alloy

## Recommended Cutting Conditions

Si content ≤ 12,6 %

Min. - Optimum - Max.

ISO	Work Material	Hardness	Cutting Speed $v_c$ (m/min)	Feed Rate $f_z$ (mm/t)	Grade
<b>N</b>	Aluminum Alloy	—	2.000–2.500–3.000	0,05–0,13–0,20	DA1000

Si content > 12,6 %

Min. - Optimum - Max.

ISO	Work Material	Hardness	Cutting Speed $v_c$ (m/min)	Feed Rate $f_z$ (mm/t)	Grade
<b>N</b>	Aluminum Alloy	—	400–600–800	0,05–0,13–0,20	DA1000 DA90

Combined Milling of Cast Iron/Aluminum Alloy

Min. - Optimum - Max.

ISO	Work Material	Hardness	Cutting Speed $v_c$ (m/min)	Feed Rate $f_z$ (mm/t)	Grade
<b>K</b> <b>N</b>	Cast Iron/ Aluminum Alloy	—	300–400–500	0,05–0,13–0,20	DA90

The above recommended cutting conditions are meant as a guide. Actual conditions will depend on the individual machine rigidity, work clamp rigidity, depth of cut and other factors.

## Spare Parts

Sold separately.

Applicable Cutters	Clamp Screw		Adjustment Screw	Wrench	Adjustment Wrench	Centre Bolt		Assembly Wrench
ANXA 16080R(S)_ 16100R(S)_ 16125R(S)_ 16160R(S)_	BXA0310IP	2,0	HFJ	TRXW10IP	ANT	BXH1235-D33	50	HFVT
						BXH2036-D50	200	

The adjustment spanner (ANT) can also be used for height adjustment of the RF type cutters for high speed machining and the HF type cutters for high efficiency machining.

## Wiper Blade Step Amount

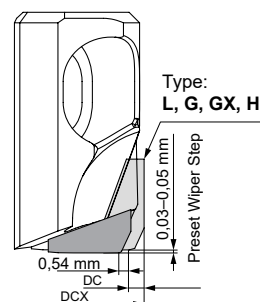

When using the wiper blade, in order to maintain balance, be sure to use a cutter with an even number of cutting edges and place the wiper blades at opposite positions.

## Max. Allowable Spindle Speed

Cat. No.	n max (min <sup>-1</sup> )
ANXA 16080RS06	20.000
16080RS10	20.000
16080RS14	20.000
16100RS08	18.000
16100RS12	18.000
16100RS18	18.000
16125RS10	16.000
16125RS14	16.000
16125RS22	16.000
16160RS12	14.000
16160RS20	14.000
16160RS28	14.000
ANXA 16080R06	20.000
16080R10	20.000
16080R14	20.000
16100R08	18.000
16100R12	18.000
16100R18	18.000
16125R10	16.000
16125R14	16.000
16125R22	16.000
16160R12	14.000
16160R20	14.000
16160R28	14.000

# Alnex ANXS 16000 R(S)

Expansion

Rake Angle	Radial	+5°	3 mm	90°
	Axial	+5°		

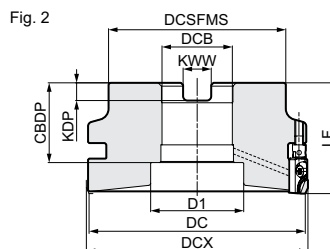
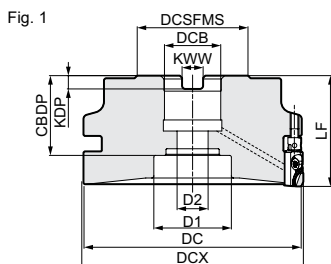

## Body - ANXS (Steel)

Dimensions (mm)

	Cat. No.	Stock	DC	DCX	DCSFMS	LF	DCB	KWW	KDP	CBDP	D1	D2	No. of Teeth	Weight (kg)	Fig.
Metric	ANXS 16040RS04	○	38	40	38,5	40	16	8,4	5,6	26	14	9	4	0,3	1
	16040RS06	●	38	40	38,5	40	16	8,4	5,6	26	14	9	6	0,3	1
	16050RS04	○	48	50	48,5	40	22	10,4	6,3	26	18	11	4	0,4	1
	16050RS06	●	48	50	48,5	40	22	10,4	6,3	26	18	11	6	0,4	1
	16050RS09	○	48	50	48,5	40	22	10,4	6,3	26	18	11	9	0,5	1
	16063RS06	○	61	63	50	40	22	10,4	6,3	26	18	11	6	0,7	1
	16063RS08	●	61	63	50	40	22	10,4	6,3	26	18	11	8	0,7	1
	16063RS12	●	61	63	50	40	22	10,4	6,3	26	18	11	12	0,7	1
	16080RS06	○	78	80	50	40	27	12,4	7	34	35	14	6	1,2	1
	16080RS10	○	78	80	50	50	27	12,4	7	34	35	14	10	1,2	1
	16080RS14	○	78	80	50	50	27	12,4	7	34	35	14	14	1,2	1
	16100RS08	○	98	100	80	50	32	14,4	8	32	46	-	8	1,9	2
	16100RS12	○	98	100	80	50	32	14,4	8	32	46	-	12	2,0	2
	16100RS18	○	98	100	80	50	32	14,4	8	32	46	-	18	2,0	2
	16125RS10	○	123	125	80	63	40	16,4	9	35	52	-	10	3,8	2
16125RS14	○	123	125	80	63	40	16,4	9	35	52	-	14	3,9	2	
16125RS22	○	123	125	80	63	40	16,4	9	35	52	-	22	3,9	2	
Inch	ANXS 16063R06	○	61	63	50	50	25,4	9,5	6	31	20	14	6	0,9	1
	16063R08	○	61	63	50	50	25,4	9,5	6	31	20	14	8	0,9	1
	16063R12	○	61	63	50	50	25,4	9,5	6	31	20	14	12	0,9	1
	16080R06	○	78	80	50	50	25,4	9,5	6	34	35	14	6	1,2	1
	16080R10	○	78	80	50	50	25,4	9,5	6	34	35	14	10	1,2	1
	16080R14	○	78	80	50	50	25,4	9,5	6	34	35	14	14	1,2	1
	16100R08	○	98	100	80	50	31,75	12,7	8	36	42	-	8	1,9	2
	16100R12	○	98	100	80	50	31,75	12,7	8	36	42	-	12	2,0	2
	16100R18	○	98	100	80	50	31,75	12,7	8	36	42	-	18	2,0	2
	16125R10	○	123	125	80	63	38,1	15,9	10	42,5	52	-	10	3,9	2
	16125R14	○	123	125	80	63	38,1	15,9	10	42,5	52	-	14	3,9	2
16125R22	○	123	125	80	63	38,1	15,9	10	42,5	52	-	22	3,9	2	

Blades are sold separately. If using a blade for corner radius machining (ANB1604R/ANB1608R), DC = DCX. The weight includes the weight of the blade and parts (excluding the centre bolt).

## Identification Details

<b>ANX</b>	<b>S</b>	<b>16</b>	<b>100</b>	<b>R</b>	<b>S</b>	<b>18</b>
Cutter Series	Steel Body	Blade Size	Cutter Diameter	Feed Direction	Metric	Number of Teeth

● = Euro stock  
○ = Japan stock

□ = Delivery on request

Recommended Tightening Torque (N·m)



Dimensions (mm)

## Blades

Application	SUMIDIA	CVD						
High Speed / Light Cut								
General Purpose								
Roughing								
Cat. No.	DA1000	DA90	SCV10	Cutting Edge Length	RE	Wiper Edge Shape	Applications	Fig.
ANB 1600R-L	●	—	—	6,0	—	Linear	Low Cutting Force	1
1600R-G	●	—	—	6,0	—	Arc-Shaped	General Purpose	1
1600R-GB	●	●	—	6,0	—	Arc-Shaped	Combined Milling*	1
1600R-H	●	—	—	6,0	—	Arc-Shaped	Strong Edge	1
1600R-GX	○	—	—	9,0	—	Arc-Shaped	Long Edge	2
1604R	○	—	—	6,0	0,4	Linear	Corner Radius	3
1608R	○	—	—	6,0	0,8	Linear	Corner Radius	3
1600R-W	○	—	—	2,0	—	Arc-Shaped	Wiper	4
1600R-WS	—	—	□	—	—	Arc-Shaped	Wiper	5

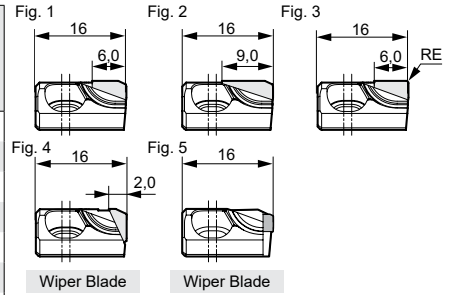

\* Cast Iron/Aluminum Alloy

## Recommended Cutting Conditions

Si content ≤ 12,6 %

Min. - Optimum - Max.

ISO	Work Material	Hardness	Cutting Speed $v_c$ (m/min)	Feed Rate $f_z$ (mm/t)	Grade
	Aluminum Alloy	—	2.000–2.500–3.000	0,05–0,13–0,20	DA1000

Si content > 12,6 %

Min. - Optimum - Max.

ISO	Work Material	Hardness	Cutting Speed $v_c$ (m/min)	Feed Rate $f_z$ (mm/t)	Grade
	Aluminum Alloy	—	400–600–800	0,05–0,13–0,20	DA1000 DA90

Combined Milling of Cast Iron/Aluminum Alloy

Min. - Optimum - Max.

ISO	Work Material	Hardness	Cutting Speed $v_c$ (m/min)	Feed Rate $f_z$ (mm/t)	Grade
 	Cast Iron/ Aluminum Alloy	—	300–400–500	0,05–0,13–0,20	DA90

The above recommended cutting conditions are meant as a guide. Actual conditions will depend on the individual machine rigidity, work clamp rigidity, depth of cut and other factors.

## Spare Parts

Sold separately.

Applicable Cutters	Clamp Screw		Adjustment Screw	Wrench	Adjustment Wrench	Centre Bolt		Assembly Wrench
ANXS 16040RS_	BXA0310IP	2,0	HFJ	TRXW10IP	ANT	BXH0825-D13	15	HFVT
16050RS_						BXH1030-D16	25	
16063RS_						BXH1235-D33	50	
16080RS_						BXH1635-D40	100	
16100RS_						BXH2036-D50	200	
16125RS_	BXH1235-D18	40						
16063R_	BXA0310IP	2,0	HFJ	TRXW10IP	ANT	BXH1235-D33	50	
16080R_						BXH1635-D40	100	
16100R_						BXH2036-D50	200	
16125R_						BXH2036-D50	200	

The adjustment spanner (ANT) can also be used for height adjustment of the RF type cutters for high speed machining and the HF type cutters for high efficiency machining.

## Wiper Blade Step Amount

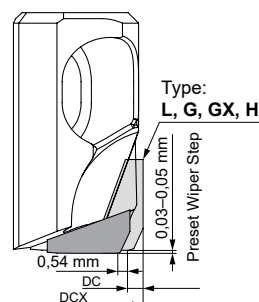

When using the wiper blade, in order to maintain balance, be sure to use a cutter with an even number of cutting edges and place the wiper blades at opposite positions.

## Max. Allowable Spindle Speed

Cat. No.	n max (min <sup>-1</sup> )
ANXS 16040RS04	25.000
16040RS06	25.000
16050RS04	25.000
16050RS06	25.000
16050RS09	25.000
16063RS06	22.000
16063RS08	22.000
16063RS12	22.000
16080RS06	20.000
16080RS10	20.000
16080RS14	20.000
16100RS08	18.000
16100RS12	18.000
16100RS18	18.000
16125RS10	16.000
16125RS14	16.000
16125RS22	16.000
ANXS 16063R06	22.000
16063R08	22.000
16063R12	22.000
16080R06	20.000
16080R10	20.000
16080R14	20.000
16100R08	18.000
16100R12	18.000
16100R18	18.000
16125R10	16.000
16125R14	16.000
16125R22	16.000

# SUMIDIA Face Mill

## RF Type

### High Speed Finishing of Aluminium Alloy



Fig. 1

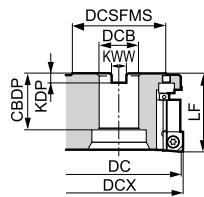
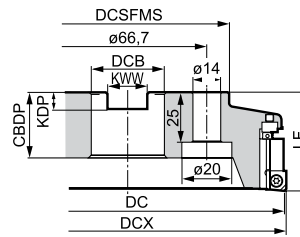

Fig. 2



#### Body

Cat. No.	Stock	Dimensions (mm)								No. of Teeth	Max. Depth of Cut	Weight (Kg)	Fig.
		DC	DCX	DCSFMS	LF	DCB	KWW	KDP	CBDP				
RF 4080 RS	●	80	82	60	50	27	12,4	7,0	29	6	3,0	0,7	1
RF 4100 RS	□	100	102	75	50	32	14,4	8,5	29	6		1,0	1
4125 RS	●	125	127	75	63	40	16,4	9,5	29	8		1,6	1
4160 RS	□	160	162	100	63	40	16,4	9,5	29	10		2,6	2

Remark: PCD blades and inserts are not included.

#### Insert for Roughing and Finishing

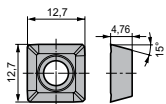

Fig. 1

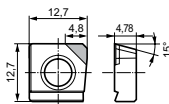

Fig. 2

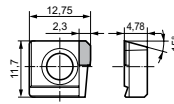
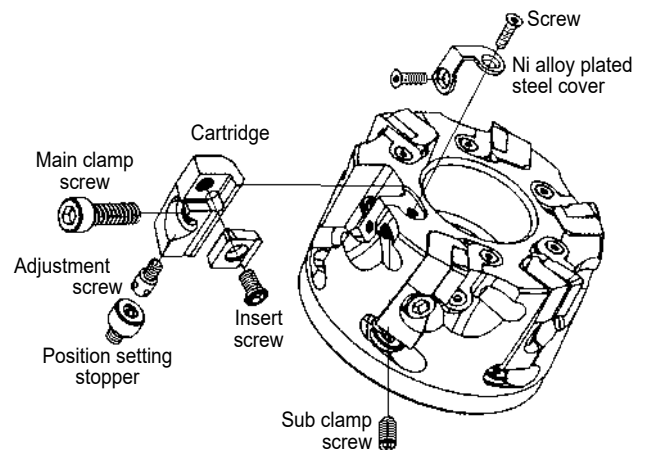

Fig. 3

Application	Carbide			SUMIDIA	
	H1	DA1000	DA2200	Fig.	
High Speed / Light cut	N	N	N	1	
General Purpose	N	N	N	2	
Roughing	N	N	N	3	

#### Structure



#### "Sumidia" Blade

PCD grade DA2200	Cat. No.	Stock
Standard type	RFB	□
Wiper type	RFBW	□

#### Dummy Blade

	RFD	○
--	-----	---

#### Cartridge

Shape	Cat. No.	Stock
For carbide insert	RFR	●
For Sumidia insert	RFF	●

#### Cutting Insert Selection

##### For easy assembling:

PCD blade **RFB**  
PCD blade **RFB** (wiper type)

##### For finishing:

Cartridge **RFF**  
PCD insert SNEW 1204 ADFR-NF (standard type)  
SNEW 1204 ADFR-W-NF (wiper type)  
PCD grade: DA1000

##### For roughing:

Cartridge **RFR**  
Uncoated carbide insert  
SDET 1204 ZDFR, grade: H1

#### Spare Parts

RFC	RFS	BX0620	BTD0510	FBUP2-A0-8	RFJ	BFTX0509N	TH050 TH015, TH025 TH015, TH025 TH050	TTX20

#### Setting Gauge

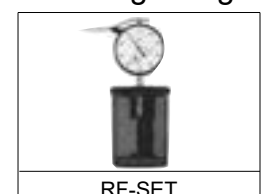

Dial-gauge is not included.

● = Euro stock  
○ = Japan stock

□ = Delivery on request  
▲ = To be replaced by new item

# SUMIDIA Face Mill SRF Type

## High Speed Finishing of Aluminium Alloy



Fig. 1

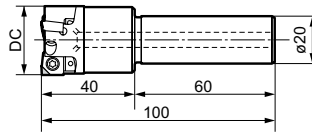
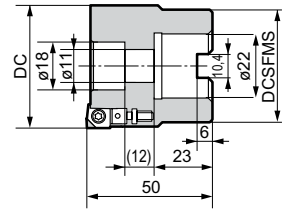

Fig. 2



### Body

Cat. No.	Stock	Dimensions (mm)		No. of teeth	Fig.	Weight (Kg)
		DC	DCSFMS			
SRF 30 R-ST	○	30	-	3	1	0,34
SRF 40 R-ST	○	40	-	4	1	0,50
SRF 50 RS	□	50	46,5	5	2	0,59
SRF 63 RS	□	63	45,0	6	2	0,67

Inserts are sold separately.

### Inserts

Dimensions (mm)

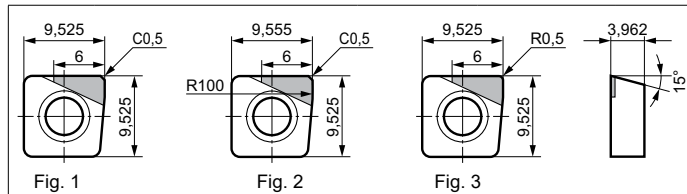

Application	SUMIDIA
High Speed / Light cut	<b>N</b>
General Purpose	<b>N</b>
Roughing	<b>N</b>

Cat. No.	DA1000	Cutting Edge	Fig.
SNEW 09T3 ADTR-NF	□	Standard	1
09T3 ADTR-U-NF	□	Wiper	2
09T3 ADTR-R-NF	○	Nose Radius	3

- Standard inserts and Wiper inserts can be used on the same cutter body.
- Standard inserts with nose radius should be used where vibration is present. As such, Wiper-inserts will not be applicable.
- Inserts can be regrind 3 times (up to minimum IC diameter 9,225 mm).
- When using reground inserts, it is advisable to reconfirm insert height and cutting diameter with a tool pre-setter.
- Do not mix new and reground inserts, or even inserts with different regrind amount on the same cutter.

### Spare Parts

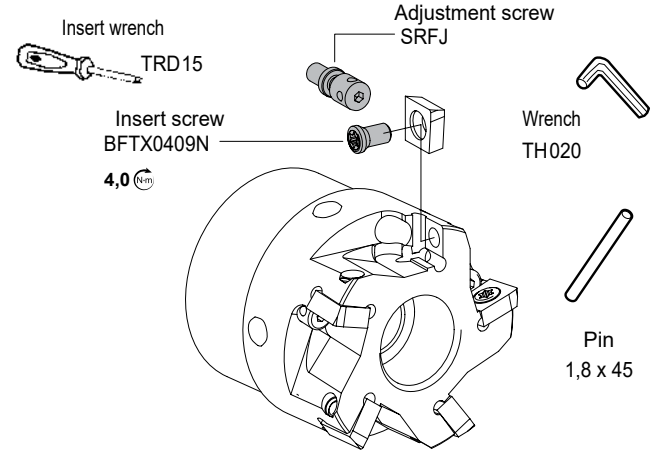

### Maximum D.O.C. Guide (SRF50RS, 5 teeth)

The contains guidelines on the maximum D.O.C., determined from internal tests. "O" mark indicates the possible application range. Actual cutting conditions should be set, based on actual machine and work characteristics.

Feed D.O.C. (mm)	Feed Speed, $v_f$ (mm/min)		
	2.500	4.000	5.000
	Feed Rate, $f_z$ (mm/tooth)		
	0,05	0,08	0,10
0,5	○	○	○
1,0	○	○	○
1,5	○	○	○
2,0	○	○	○
2,5	○	○	○
3,0	○	○	○
3,5	○	○	-
4,0	○	-	-
4,5	○	-	-
5,0	○	-	-

### Cutting Conditions

Cutter: SRF 50 RS  
 Insert: SNEW 09T3 ADFR-NF (DA1000)  
 n : 10.000 rpm  
 Width: 35mm at D.O.C. indicated above

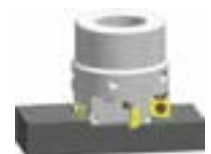

### Recommended Cutting Conditions for RF and SRF Type Cutters

Work Material		Process	Grade	Cutting Speed (m/min)		Feed Rate (mm/tooth)	Depth of Cut (mm)	
				RF Type	SRF Type		RF Type	SRF Type
Aluminium Alloy	Si < 13 %	Finishing	DA1000 (PCD)	2.000-5.000	-4.000	0,05-0,2	-3,0	-5,0
		Roughing	H1 (Carbide)	1.000-2.500	-			
	Si ≥ 13 %	Finishing	DA1000 (PCD)	400-800	-800			
		Roughing	H1 (Carbide)	200-400	-			



# SUMIBORON "BN Finish Mill" FMU Type

## High Speed Finishing of Grey Cast Iron



### ■ Features

- High speed machining  $v_c=1.500\text{m/min}$
- Excellent surface roughness  $R_z = 3,2$  ( $R_a = 1,0$ )
- Safety structure for the centrifugal force under high speed cutting conditions
- Run-out is less than  $10\ \mu\text{m}$
- Easy assembling method using the setting gauge
- Running cost is reduced because of economical insert

## SUMIBORON "BN Finish Mill"

### ■ Application

GG25–GG30 (HB200–250) grey cast iron with pearlite matrix, and ferrite matrix (HB130–160)

Application examples: engine block, cylinder block, etc

### ■ Specifications

FMU Type:  $\varnothing 80\text{--}\varnothing 315\ \text{mm}$   
 Insert: SNEW1203ADTR/L  
 Low cutting force type: SNEW1203ADTR/L-S

### ■ Recommended Cutting Conditions

Speed:  $v_c = 800\text{--}2000\ \text{m/min}$   
 Feed:  $f_z = 0,1\text{--}0,3\ \text{mm/tooth}$   
 Depth:  $a_p = 0,5\ \text{mm or less}$   
 Dry cutting



### ■ Performance

#### ● Tool Life Diagram

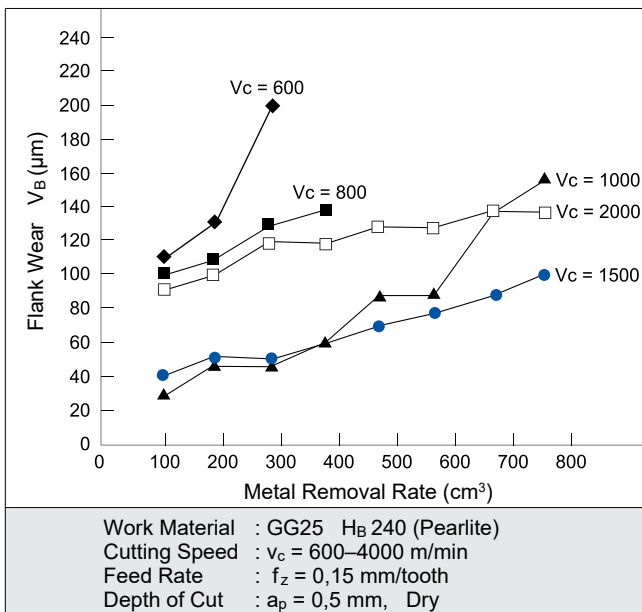

#### ● Estimated Tool Life

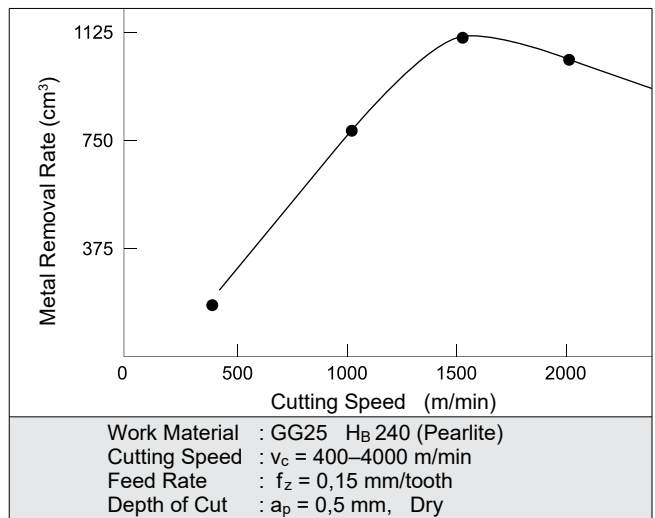

- Milling of ductile cast iron and alloy steel casting do not produce the best results.
- Dry cutting is recommended. Wet cutting will result in chipping of cutting edges in the early stages due to thermal cracking.

# SUMIBORON "BN Finish Mill" FMU Type

## Specifications

Approach angle: 90°  
Axial rake angle: + 8°  
Radial rake angle: + 2°

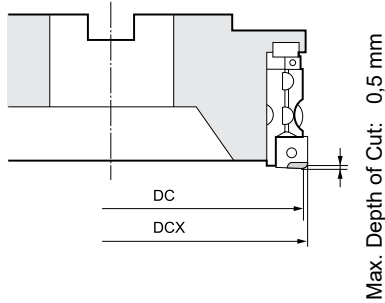

## Structure

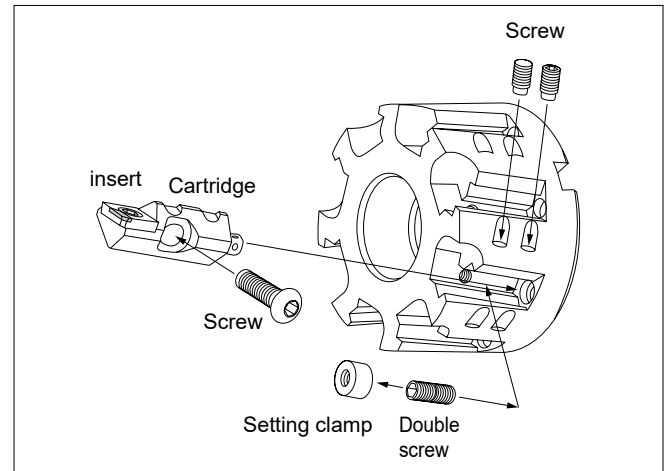

## Body

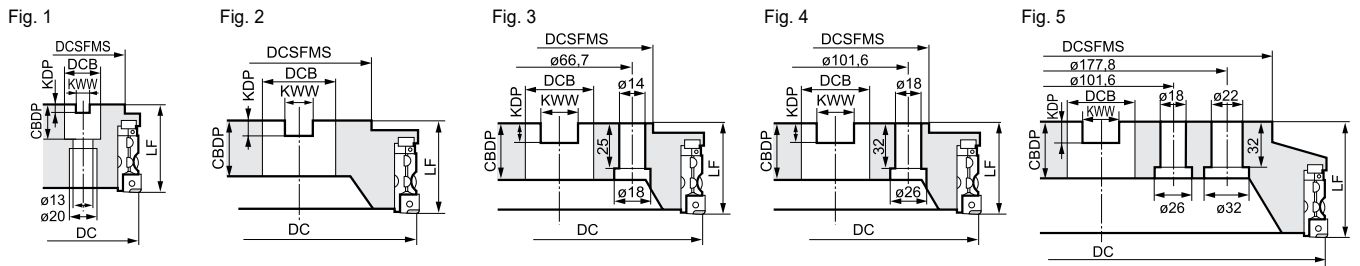

Cat. No.	Stock	Dimensions (mm)									No. of Teeth	Max. Depth of Cut	Weight (Kg)	Fig.
		DC	DCX	DCSFMS	LF	DCB	KWW	KDP	CBDP					
FMU 4080 RS	□	80	82,8	60	63	27	12,4	7,0	25	6	0,5	1,6	1	
FMU 4100 RS	●	100	102,8	76	63	32	14,4	8,5	29	8		2,4	2	
4125 RS	□	125	127,8	75	63	40	16,4	9,5	29	10		3,4	2	
4160 RS	□	160	162,8	100	63	40	16,4	9,5	29	12		5,6	3	
FMU 4200 RS	□	200	202,8	130	63	60	25,7	14,0	38	16		9,2	4	
4250 RS	□	250	252,8	130	63	60	25,7	14,0	38	20	14,3	4		
FMU 4315 RS		315	317,8	240	80	60	25,7	14,0	40	24	27,8	5		

## Inserts

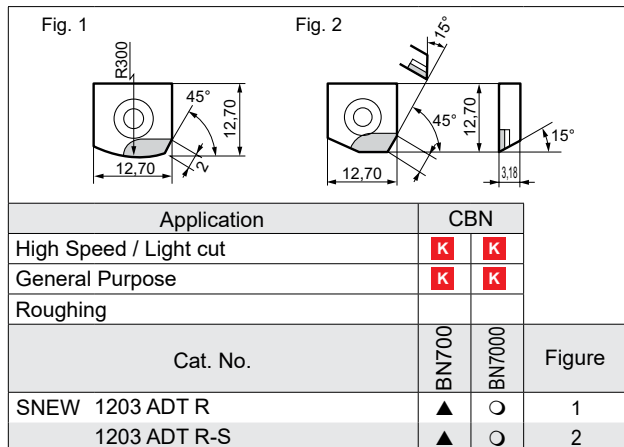

## Cartridge

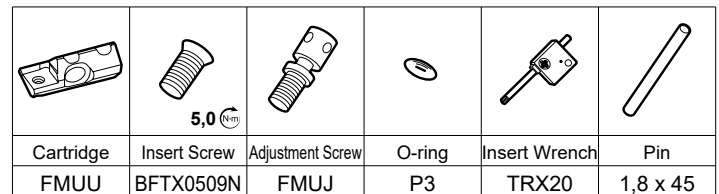

## Spare Parts

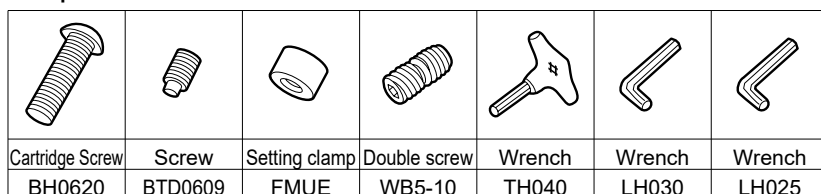

## Gauge



Dial-gauge is not included.



# Indexable Endmills

H1-H88

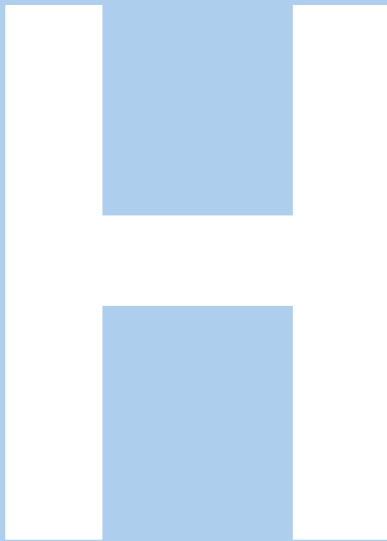

	Selection Guide	Milling Cutter Selection Guide .....	H2-3
	Exchangeable Head Endmills	According to Work Materials / Applications	
		Modular Tools .....	H4-5
<b>Face Milling</b>	"Sumi Dual", General Purpose Face Mills <small>Expansion</small>	DGC 13000 EW .....	H6
	"Wave Mill", General Purpose Face Mills <small>Expansion</small>	WGX 13000 EW .....	H7
	"Sumi Dual", High Feed Milling	DMSW 08000 E(L).....	H8
		DMSW 08000 M .....	H9
	High Feed Milling	MSX 06000/08000/12000/14000 ES/EM/EW .....	H10-11
	High Feed Milling <small>Expansion</small>	MSX 06000/08000/12000/12000 M.....	H12-13
<b>Shoulder Milling</b>	"Sumi Dual Mill" <small>Expansion</small>	WFXH 08000/12000 M .....	H14-15
	"Sumi Dual Mill" <small>Expansion</small>	DFC(M) 09000 E .....	H16-17
	"Wave Mill" for Shoulder Milling <small>Expansion</small>	WFX(F/M) 08000/12000 E.....	H18-19
		WFX 08000 M.....	H18
	"Sumi Dual Mill", tangential <small>Expansion</small>	TSX(F/M) 08000/13000 E .....	H20-23
	"Sumi Dual Mill", Repeater Mill	TSXR 08000/13000 E <small>New</small> .....	H24-25
	"Sumi Wave" for Shoulder Milling <small>Expansion</small>	WEZ .....	H26-29
		WEZ 11000 E/ES/EL .....	H30-35
		WEZ 17000 E/ES/EL .....	H36-41
		"Wave Mill", Repeater Mill	WEZR 11000/17000 E <small>New</small> .....
		WEZ 11000/17000 M.....	H46-49
		WEZR 11000/17000 M <small>New</small> .....	H50-53
	"Wave Mill" for Shoulder Milling	WEX 1000/2000/3000 E/EL/EW/M .....	H54-60
	"Wave Mill" Series for Aluminium	WAX 3000 E/EL .....	H61-62
		WAX 4000 E/EL .....	H63
	Repeater Mill	WRX 2000 / 3000 .....	H64-67
<b>Others</b>	Shoulder Milling Cutter for Titanium	MTIX 16000 <small>New</small> .....	H68-69
	"Wave Ball-Mill" for Roughing	WBMR 2000/2000L .....	H70-71
	"Wave Ball-Mill" for Finishing	WBMF 1000.....	H72-73
	"Wave Radius Mill" with Polygon Inserts	WRCX 08000/10000 E .....	H74
		08000/10000/12000 M .....	H75
	"Wave Radius Mill" with Round Inserts	RSX(F) 08000/10000/12000 ES.....	H76
		08000/10000/12000 M .....	H77
	"Wave Mill" for Chamfering <small>Expansion</small>	WFXC 08000/12000 E.....	H78-79
		WFXC 08000/12000 M .....	H80
	High Speed Non-Ferrous Mill <small>Expansion</small>	ANX .....	H82-83
	ANXS 16000 E .....	H84-85	
	ANXS 16000 M <small>New</small> .....	H86-87	







# Exchangeable Head Endmills Modular Tools



## General Features

Indexable head endmills are available in 10 types:

<b>WEZ</b>	<b>MSX</b>
<b>WEX</b>	<b>RSX</b>
<b>WFX</b>	<b>WRXC</b>
<b>DMSW</b>	<b>WFXC</b>
<b>WFXH</b>	<b>ANXS</b>

In addition to carbide arbors and steel arbors, the lineup of integrated BBT types enables a variety of combinations.

General-purpose grade applicable to any work material. Introducing the new grade ACU2500, which is applicable to a wide variety of processes and work materials such as steel, stainless steel and cast iron.

Suitable for milling with **long overhangs** when combined with carbide or steel arbors!



Easy to change screw-on endmill type WEX and carbide arbor

When combined with BBT integrated arbors, **high load milling** is supported.



RSX type + BBT30 integrated arbor

### Modular Head + Carbide Arbor

### Standard Shank Type Endmill

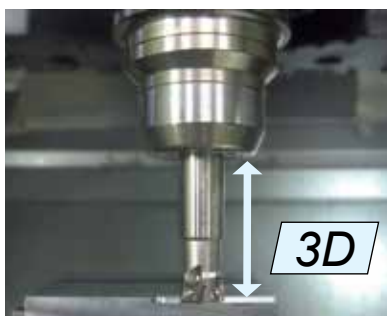
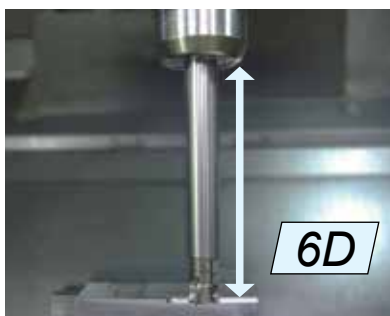

Note: Cutting conditions can vary according to cutter reach, rigidity of machine tool / workpiece etc.

### Screw Size and Mounting Cutter Size

Screw CRKS	Applicable Cutter Size (DC)
M8	Ø 16, Ø 18
M10	Ø 20, Ø 22
M12	Ø 24, Ø 28
M16	Ø 30, Ø 32, Ø 35, Ø 40

## Performance

● A Carbide Arbor improves feed rates, surface finish, sizing, and tool life.

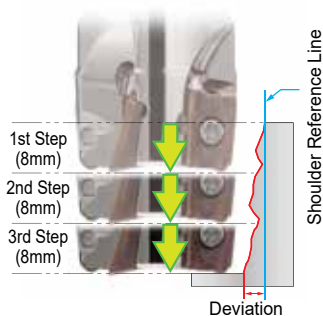

### Shoulder Milling Squareness

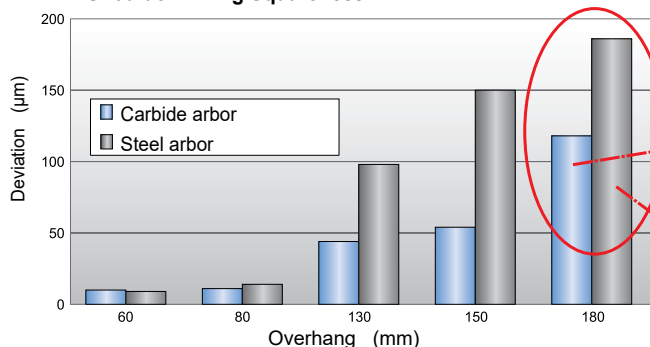

### Carbide Arbor Comparison ...

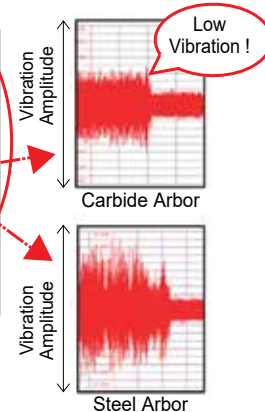

Work Material : C50  
 Tool : WEX2025M12Z4 (ø D = 25, 4 teeth)  
 Cutting Conditions:  $v_c = 100$  m/min,  $f_z = 0,1$  mm/tooth  
 $a_p = 8$  mm x 3 passes,  $a_e = 2,0$  mm, Equipment: M/C BT50

● = Euro stock  
 ○ = Japan stock

Ⓜ Recommended Tightening Torque (N·m)

# Exchangeable Head Endmills Modular Tools

## ■ BBT Integrated Type - Modular Tools Special Arbors

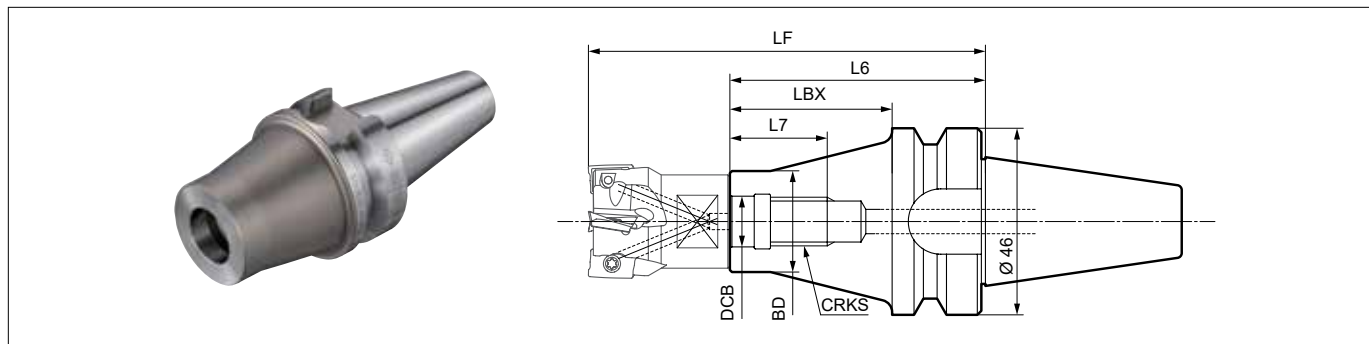

## ■ BBT Integrated Arbor

Dimensions (mm)

Cat. No.	Stock	CRKS	DCB	BD	L6	LBX	L7	LF*	Coolant Hole
BBT30-M8-50	○	M8	8,5	15,9	73	50	18	98	Yes
M10-45	○	M10	10,5	19,9	68	45	20	98	Yes
M12-40	○	M12	12,5	24,9	63	40	22	98	Yes
M16-35	○	M16	17	31,9	58	35	24	98	Yes

\* Overhang length for LF is with head mounted. Can also be used with BT30 special machines.

## ■ Carbide and Steel Arbor

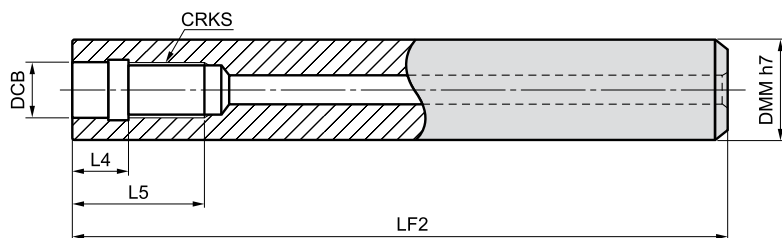
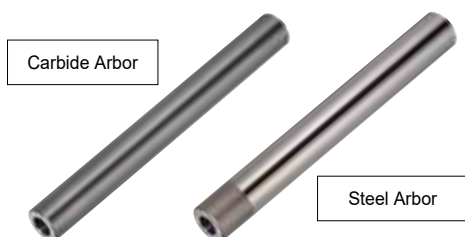

## ■ Carbide Arbor

Cat. No.	Stock	Dimensions (mm)						
		CRKS	DCB	DMM	LF2	L4	L5	LF*
MA 15 M08 L120C	●	M8	8,5	15	120	10	18	145
15 M08 L160C	●	M8	8,5	15	160	10	18	185
MA 16 M08 L120C	●	M8	8,5	16	120	10	18	145
16 M08 L160C	●	M8	8,5	16	160	10	18	185
MA 18 M10 L150C	●	M10	10,5	18	150	10	20	180
18 M10 L200C	●	M10	10,5	18	200	10	20	230
MA 20 M10 L150C	●	M10	10,5	20	150	10	20	180
20 M10 L200C	○	M10	10,5	20	200	10	20	230
MA 23 M12 L200C	●	M12	12,5	23	200	10	22	235
23 M12 L250C	●	M12	12,5	23	250	10	22	285
MA 25 M12 L200C	●	M12	12,5	25	200	10	22	235
25 M12 L250C	●	M12	12,5	25	250	10	22	285
MA 28 M16 L200C	●	M16	17,0	28	200	10	24	240
28 M16 L300C	●	M16	17,0	28	300	10	24	340
MA 32 M16 L200C	●	M16	17,0	32	200	10	24	240
32 M16 L300C	●	M16	17,0	32	300	10	24	340

## ■ Steel Arbor

Cat. No.	Stock	Dimensions (mm)						
		CRKS	DCB	DMM	LF2	L4	L5	LF*
MA 16 M08 L120S	●	M8	8,5	16	120	10	18	145
MA 20 M10 L150S	●	M10	10,5	20	150	10	20	180
MA 25 M12 L200S	●	M12	12,5	25	200	10	22	235
MA 32 M16 L200S	●	M16	17,0	32	200	10	24	240

## ■ Identification of Catalogue No.

**MA 15 M08 L120 C**

Modular Arbor      Mounting Screw      Shank Diameter      Arbor Length      Material  
C: Carbide  
S: Steel

## ■ Recommended Tightening Torque

Screw	Wrench		N·m
	W	S	
M 8	8	13	23
M10	8	15	46
M12	10	19	60
M16	10	24	80



Notes about tightening the head:

- Refer to the Head Cat. No. chart on pages H18, H19, H35 and H37 to select the arbor size in the table above.
- Check the mounting screw size of the head and arbor beforehand.
- When attaching head to an arbor, follow the standard tightening torque in the table above.

## ● Modular Tool System

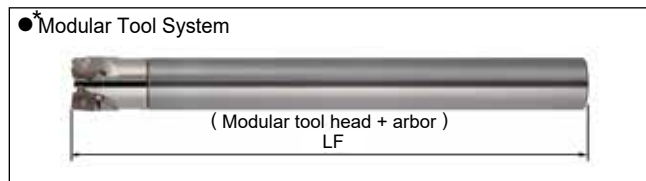

# "Sumi Dual Mill" Face Mill

## DGC (EW) Type

Expansion

General Milling for Steel and Cast Iron

### Body – Shank Type

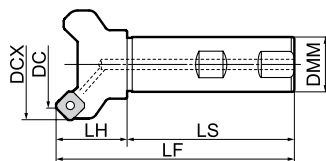

Rake Angle	Radial	-10°	SNMU / SNEU 6 mm / 45°	ONMU / ONEU 3 mm / 45°
	Axial	-5°		

### Body

Cat. No.	Stock	Dimensions (mm)						No. of Teeth	Weight (kg)
		DC	DCX	DMM	LH	LS	LF		
DGC 13040 EW	●	40 (42,90)	54	32	40 (38,44)	85	125	3	0,7
13050 EW	○	50 (52,90)	65	32	40 (38,44)	85	125	3	0,9
13063 EW	○	63 (65,90)	77	32	40 (38,44)	85	125	4	1,1

( ) Figures in brackets indicate values for inserts of type ONMU

### Identification Details

<b>DGC</b>	<b>13</b>	<b>040</b>	<b>EW</b>
Cutter Series	Insert Size	Cutter Diameter	Endmill Type Weldon

### Inserts

Application	Coated Carbide								Cermets		
	P	M	K	K	M	S	P	M			
High Speed/Light cut	●	●	●	●	●	●	●	●	●		
General Purpose	●	●	●	●	●	●	●	●	●		
Roughing	●	●	●	●	●	●	●	●	●		
Cat. No.	ACU2500	XCU2500	ACP100	ACP200	ACP300	XCK2000	ACK200	ACK300	ACM200	ACM300	T4500A
SNMU 13T6ANER L	●	○	●	●	●	○	●	●			
13T6ANER G	●	○	●	●	●	○	●	●			
13T6ANER H	●	○	●	●	●	○	●	●			
13T6ANER FL	●	○	●	●	●	○	●	●			
13T6ANER FG	●	○	●	●	●	○	●	●			
SNEU 13T6ANER L									●	●	
13T6ANER G									●	●	
13T6ANER FL									○	○	
13T6ANER FG									○	○	
XNEU 13T6ANER W	●	○	●			○	●				●
ONMU 05T6ANER L	●	○	●	●	●	○	●	●			
05T6ANER G	●	○	●	●	●	○	●	●			
ONEU 05T6ANER L									●	●	
05T6ANER G									●	●	

Dimensions (mm)

Fig. 1

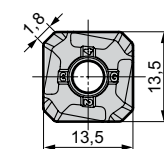

Fig. 2

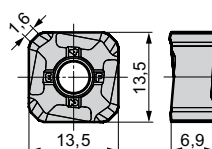

Fig. 3

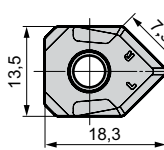
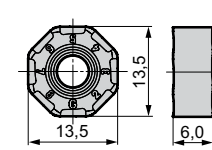

Fig. 4



### Attaching Octagonal Inserts

Firmly align insert with supporting face, press down in the direction of the arrow and tighten the screw to fix the insert.

Press down firmly from above

Align with supporting faces

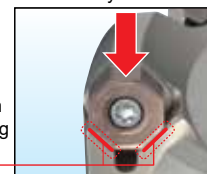

### Spare Parts

Shim	Shim Screw	L Seat Wrench	Insert Screw	Insert Wrench
DGCS 13 R	BW 0609 F	LH 040	BFTX 0412 IP	TRDR 15 IP

### Optional

Insert Screw (*)
BFTX 0418 IP

\*Corners can be changed simply by loosening the screw. (Only suitable for DGC / DGCM types with body size ≥ Ø 80).

### SNMU – Recommended Cutting Conditions

ISO	Work Material	Hardness (HB)	Cutting Speed v <sub>c</sub> (m/min)	Feed Rate f <sub>z</sub> (min/t)	Depth of Cut (mm)	Grade
P	General Steel	180–280	150–200–250	0,10–0,25–0,40	<4	ACU2500
	Alloyed Steel	≤180	180–250–350	0,10–0,30–0,45	<4	ACP200 ACP300
	Die Steel	200–220	100–150–200	0,15–0,25–0,35	<4	XCU2500
M	Stainless Steel	–	160–200–250	0,15–0,23–0,30	<3	ACU2500 ACM300
K	Cast Iron	250	100–200–250	0,10–0,25–0,40	<5	ACU2500 ACK200 ACK300 XCU2500 XCK2000
S	Exotic Steel	–	30–50–80	0,10–0,20–0,30	<3	ACU2500 ACM200 ACM300

Min. – Optimum – Max.

### ONMU – Recommended Cutting Conditions

ISO	Work Material	Hardness (HB)	Cutting Speed v <sub>c</sub> (m/min)	Feed Rate f <sub>z</sub> (min/t)	Depth of Cut (mm)	Grade
P	General Steel	180–280	150–200–250	0,10–0,30–0,50	<2	ACU2500
	Alloyed Steel	≤180	180–250–350	0,10–0,50–0,50	<2	ACP200 ACP300
	Die Steel	200–220	100–150–200	0,15–0,25–0,30	<2	XCU2500
M	Stainless Steel	–	160–200–250	0,15–0,23–0,30	<2	ACU2500 ACM300
K	Cast Iron	250	100–200–250	0,10–0,30–0,50	<2	ACU2500 ACK200 ACK300 XCU2500 XCK2000
S	Exotic Steel	–	30–50–80	0,10–0,20–0,30	<2	ACU2500 ACM200 ACM300



# "Sumi Wave" Face Mill WGX (EW) Type

General Milling for Steel and Cast Iron

## Body – Shank Type

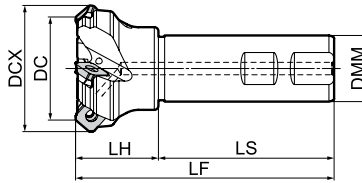

Rake Angle	Radial	-20°–24°	6 mm 45°
	Axial	20°–22°	

## Body – Dimensions

Cat. No.	Stock	Dimensions (mm)						No. of Teeth
		DC	DCX	DMM	LH	LS	LF	
WGX 13032 EW	○	32	44	32	40	85	125	3
13040 EW	○	40	52	32	40	85	125	3
13050 EW	○	50	62	32	40	85	125	4
13063 EW	○	63	76	32	40	85	125	5

Inserts are not included.  
ø 32 mm cutters do not have a seat.

## Identification Details

<b>WGX</b>	<b>13</b>	<b>032</b>	<b>EW</b>
Cutter Series	Insert Size	Cutter Diameter	Endmill Type Weldon

## Insert Shape Characteristics

Unique wiper edge shape for improved surface roughness

General-purpose  
G type chipbreaker

Low-burr design  
FG type chipbreaker

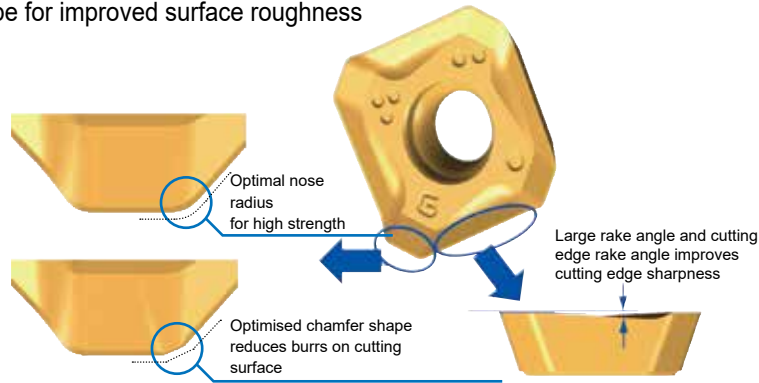

## Inserts

Application	Coated Carbide								Carb.	DLC	Cermet	Fig.	
	ACU2500	XCU2500	ACP100	ACP200	ACP300	XCK2000	ACK200	ACK300	ACM200	ACM300	H1		DL1000
High Speed/Light Cut	●	●	●	●	●	●	●	●	●	●	○	○	○
General Purpose	●	●	●	●	●	●	●	●	●	●	○	○	○
Roughing	●	●	●	●	●	●	●	●	●	●	○	○	○
Cat. No.	ACU2500	XCU2500	ACP100	ACP200	ACP300	XCK2000	ACK200	ACK300	ACM200	ACM300	H1	DL1000	T4500A
SEET 13T3AGFR-L	○	○	○	○	○	○	○	○	○	○	○	○	○
SEET 13T3AGSR-L	●	○	●	●	●	○	●	●	●	●	○	○	○
13T3AGSR-G	○	○	○	○	○	○	○	○	○	○	○	○	○
SEMT 13T3AGSR-L	●	○	●	●	●	○	●	●	●	●	○	○	○
13T3AGSR-G	○	○	○	○	○	○	○	○	○	○	○	○	○
13T3AGSR-H	○	○	○	○	○	○	○	○	○	○	○	○	○
SEMT 13T3AGSR-FG	●	○	●	●	●	○	●	●	●	●	○	○	○
XEEW 13T3AGER-WR	○	○	○	○	○	○	○	○	○	○	○	○	○

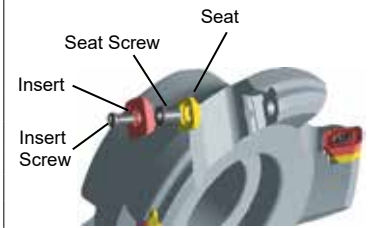
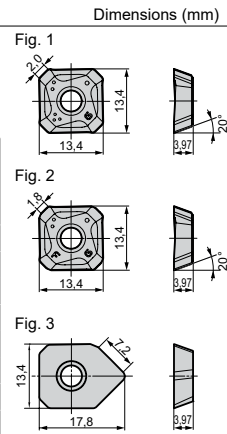

## Spare Parts

Applicable Cutters	Seat	Seat Screw	Insert Screw	Insert Wrench	(N·m)	Spanner (for Seat)
WGX 130__EW						
øD = 32	-	-	BFTX 03512 IP	TRDR 15 IP	3,0	-
øD = 40–63	WGCS 13 R	BW 0507 F	BFTX 03512 IP	TRDR 15 IP	3,0	LH 035

## Recommended Cutting Conditions

ISO	Work Material	Hardness (HB)	Cutting Speed v <sub>c</sub> (m/min)	Feed Rate f <sub>z</sub> (mm/tooth)	Grade
P	General Steel	180–280	150–200–250	0,15–0,20–0,25	ACU2500
	Soft Steel	≤180	180–265–350	0,10–0,25–0,40	ACP200
	Die Steel	200–220	100–150–200	0,15–0,20–0,25	XCU2500
M	Stainless Steel	-	160–205–250	0,15–0,23–0,30	ACU2500
K	Cast Iron	250	100–175–250	0,15–0,23–0,30	ACM300
					ACU2500
N	Non Ferrous Alloy	-	500–750–1000	0,15–0,23–0,30	ACK200
S	Exotic Alloy	-	30–50–80	0,10–0,20–0,30	XCK2000

Minimum-Optimum-Maximum

→ G10/G11

# "Sumi Dual Mill" DMSW 08000 E(L)

**New**

Rake angle	Radial	-7° to -10°	3 mm	15°
	Axial	-6°		

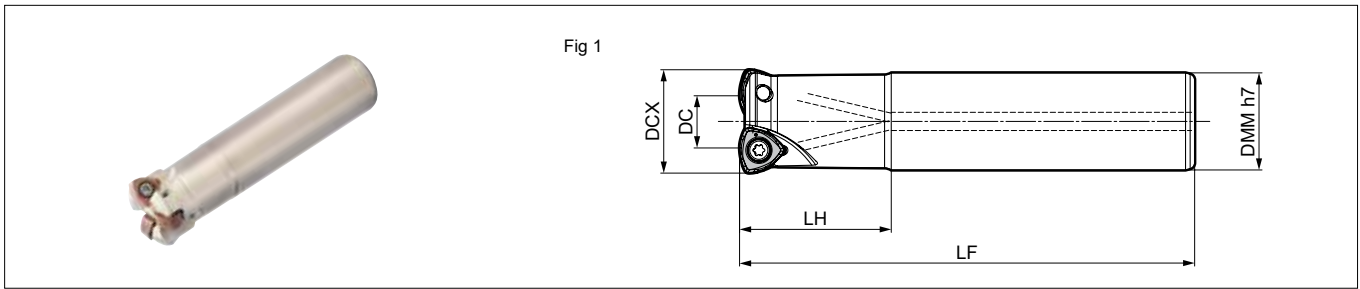

## Body (Shank Type)

Dimensions (mm)

Cat. No.	Stock	DCX	DC	DMM	LH	LF	Number of teeth	Weight (kg)	Fig.
DMSW 08035E02	●	35	18,6	32	50	150	2	0,85	1
08040E03	●	40	23,5	32	50	150	3	0,86	1
08050E03-42	●	50	33,4	42	50	150	3	1,51	1

Inserts are sold separately.



## Body (Long Shank Type)

Dimensions (mm)

Cat. No.	Stock	DCX	DC	DMM	LH	LF	Number of teeth	Weight (kg)	Fig.
DMSW 08035EL02	●	35	18,6	32	60	210	2	1,21	1
08040EL03	●	40	23,5	32	60	210	3	1,22	1
08050EL03-42	●	50	33,4	42	50	250	3	2,54	1

Inserts are sold separately.

## Parts

Insert screw	Wrench
	
BFTX0513IP	TRDR20IP

## Identification Details

**DMSW 08 050 E L 03 - 42**

Cutter series    Insert size    Cutter diameter    Shank    Long shank type    Number of teeth    Shank diameter

## Inserts

Dimensions (mm)

Application	Coated carbide					IC	S	RE	Fig.
	ACU2500	ACP2000	ACP3000	ACK2000	ACK3000				
High speed / light cut		P		K					
General purpose	P	P	P	K	K				
Roughing	P		P	K	K				
Cat. No.	ACU2500	ACP2000	ACP3000	ACK2000	ACK3000	IC	S	RE	Fig.
WNMU 0807ZNER-G	●	●	●	●	●	13	7	1,6	1
WNMU 0807ZNER-H	●	●	●	●	●	13	7	1,6	1

Fig 1

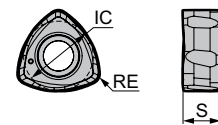

## Recommended Cutting Conditions

min.-optimum-max.

ISO	Work material	Hardness	Cutting speed $v_c$ (m/min)	Feed rate $f_z$ (mm/t)
P	General steel	< 280 HB	100-160-250	1,0-1,5-2,0
	Alloy steel	< 280 HB	100-160-200	1,0-1,5-1,8
	Alloy steel	< 42 HRC	100-150-180	0,8-1,0-1,2
M	Stainless steel	-	80-120-150	0,8-1,0-1,2
K	Cast iron	-	100-160-250	1,0-1,5-1,8
H	Hardened steel	< 52 HRC	80-100-120	0,3-0,5-0,7

The above figures are guidelines for use with BT50 machine tools at depth of cut ( $a_p$ ) of 1,5 mm.

The above recommended cutting conditions may require adjustment depending on machine rigidity and workpiece rigidity.

# Modular Type

# "Sumi Dual Mill" DMSW 08000 M

Rake angle	Radial Axial	-11° to -13° -6°	
------------	-----------------	---------------------	--

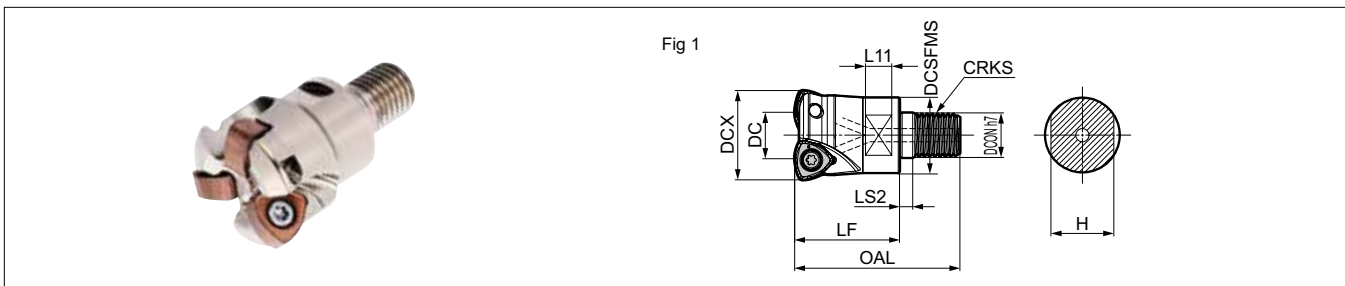

## Head

Dimensions (mm)

Cat. No.	Stock	DCX	DC	DCSFMS	DCON	CRKS	OAL	LF	LS2	L11	H	Number of teeth	Weight (kg)	Fig.
DMSW 08035M16Z2	●	35	18,6	28,5	17	M16	63	40	5	10	24	2	0,19	1
08040M16Z3	●	40	23,5	28,5	17	M16	63	40	5	10	24	3	0,21	1

Inserts are sold separately.

## Parts

Insert screw	Wrench
BFTX0513IP	TRDR20IP

## Identification Details

**DMSW 08 040 M16 Z3**

Cutter series    Insert size    Cutter diameter    Mounting screw size    Number of teeth

## Inserts

Dimensions (mm)

Application	Coated carbide								
						IC	S	RE	Fig.
High speed / light cut									
General purpose									
Roughing									
Cat. No.	ACU2500	ACP2000	ACP3000	ACK2000	ACK3000	IC	S	RE	Fig.
WNMU 0807ZNER-G	●	●	●	●	●	13	7	1,6	1
WNMU 0807ZNER-H	●	●	●	●	●	13	7	1,6	1

Fig 1

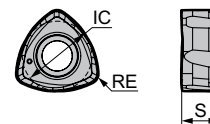

## Recommended Cutting Conditions

min.–optimum–max.

ISO	Work material	Hardness	Cutting speed $v_c$ (m/min)	Feed rate $f_z$ (mm/t)
P	General steel	< 280 HB	100–160–250	1,0–1,5–2,0
	Alloy steel	< 280 HB	100–160–200	1,0–1,5–1,8
	Alloy steel	< 42 HRC	100–150–180	0,8–1,0–1,2
M	Stainless steel	–	80–120–150	0,8–1,0–1,2
K	Cast iron	–	100–160–250	1,0–1,5–1,8
H	Hardened steel	< 52 HRC	80–100–120	0,3–0,5–0,7

The above figures are guidelines for use with BT50 machine tools at depth of cut ( $a_p$ ) of 1,5 mm.  
The above recommended cutting conditions may require adjustment depending on machine rigidity and workpiece rigidity.



→ G63-G66



# "METAL SLASH MILL" MSX Type

Ultra High Feed

Boosts Productivity – Cuts Costs



## ■ Features

The Metal Slash Mill type MSX is a new multi function high shear milling cutter with ultra high feed capability suitable for face milling, slotting, plunging and helical boring. At 50GPa the ultra hard Super ZX coated inserts feature a sharp cutting edge which demonstrates extreme resistance to wear and heat massively boosting productivity and tool life.

The vibration free cutting action ensures accurate sizing, improved surface finish, and protection of the machine tool/workpiece from damage. Inserts are double clamped in wide chip gullets to maximise rigidity and chip evacuation with temperature at the cutting edge being easily controlled via an optional air blast through integral coolant holes. The MSX cutter is readily applied to general purpose machining across the P (steel) M (stainless) and K (cast iron) range of workpiece materials with impressive results.

## ■ Advantages

**Integral Coolant Hole**  
Optimised chip removal – massive chip evacuation pockets

**Wide Application Range**  
Face milling, slotting, helical boring and plunging

**Low Cutting Force**  
Unique insert shape reduces cutting force



**Durable Cutter Body**  
Special alloyed steel with hard surface

**Double Clamp**  
Secure insert clamping for stable cutting

## ■ Application Range

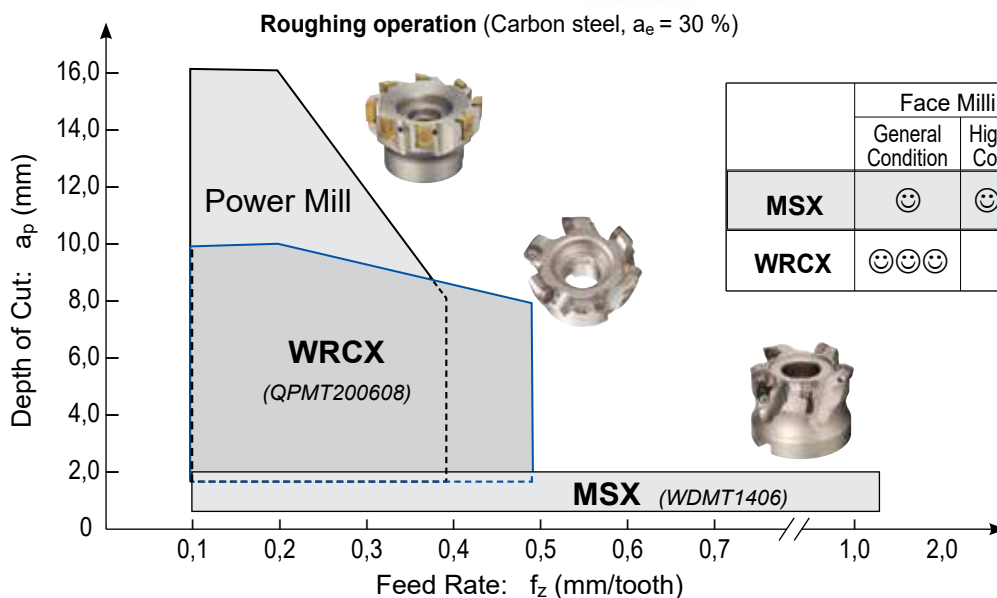

Recommended Tightening Torque (N·m)

# "METAL SLASH MILL" MSX 06000/08000 ES/EM/EW

# "METAL SLASH MILL" MSX 12000/14000 ES/EM/EW

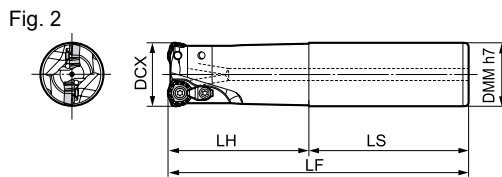
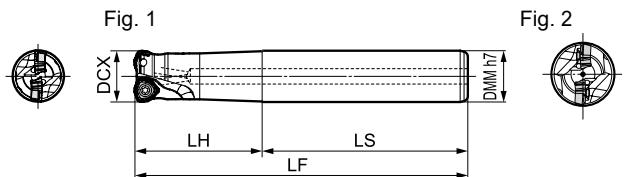
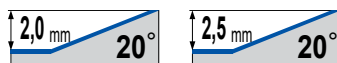
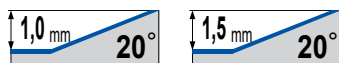

## Body For insert type : WDMT 0603 □□□□

Cat. No.	Stock	Dimensions (mm)					No. of teeth	Fig.
		DCX	DMM	LH	LS	LF		
MSX 06016 ES	□	16	16	30	80	110	2	1
06016 EM	●	16	16	70	80	150	2	1
06016 EM15	□	16	15	30	120	150	2	1
MSX 06017 EM	○	17	16	20	130	150	2	1
MSX 06018 EM	○	18	16	20	130	150	2	1
MSX 06020 ES	●	20	20	50	80	130	3	1
06020 EM	●	20	20	100	80	180	3	1
06020 EM19	□	20	19	50	130	180	3	1
MSX 06022 EM	○	22	20	30	150	180	3	1
MSX 06025 ES	●	25	25	60	80	140	3	1
06025 ES24	□	25	24	60	80	140	3	1
06025 EM	●	25	25	120	130	250	3	1
06025 EM24	□	25	24	60	190	250	3	1
MSX 06020 EW	●	20	20	50	80	130	3	1
MSX 06025 EW	●	25	25	60	80	140	3	1

## Body For insert type : WDMT 0804 □□□□

Cat. No.	Stock	Dimensions (mm)					No. of teeth	Fig.
		DCX	DMM	LH	LS	LF		
MSX 08020 ES	●	20	20	50	80	130	2	1
08020 EM	●	20	20	100	80	180	2	1
08020 EM19	□	20	19	50	130	180	2	1
MSX 08022 EM	○	22	20	30	150	180	2	1
MSX 08025 ES	●	25	25	60	80	140	2	2
08025 EM	●	25	25	120	130	250	2	2
08025 EM24	□	25	24	60	190	250	2	2
MSX 08028 EM	□	28	25	40	210	250	2	2
MSX 08032 ES	○	32	32	70	80	150	3	2
08032 EM	□	32	32	120	130	250	3	2
MSX 08035 EM	○	35	32	50	200	250	3	2
MSX 08020 EW	●	20	20	50	80	130	2	1
MSX 08025 EW	●	25	25	60	80	140	2	2
MSX 08032 EW	●	32	32	70	80	150	3	2

## Identification Details

**MSX 06 016 E S**

Cutter type    Insert size    Cutter Diameter    Shank Type    S: Short type with cylindrical shank  
M: Long type with cylindrical shank  
W: Short type with Weldon shank

## Body For insert type : WDMT 1205 □□□□

Cat. No.	Stock	Dimensions (mm)					No. of teeth	Fig.
		DCX	DMM	LH	LS	LF		
MSX 12032 ES	●	32	32	70	80	150	2	2
12032 EM	●	32	32	120	130	250	2	2
MSX 12035 EM	○	35	32	50	200	250	2	2
MSX 12040 ES	○	40	32	50	100	150	3	2
12040 EM	○	40	32	50	200	250	3	2
MSX 12050 EM	□	50	42	50	200	250	4	2
MSX 12032 EW	●	32	32	70	80	150	2	2

## Body For insert type : WDMT 1406 □□□□

Cat. No.	Stock	Dimensions (mm)					No. of teeth	Fig.
		DCX	DMM	LH	LS	LF		
MSX 14040 ES	□	40	32	50	100	150	2	2
14040 EM	□	40	32	50	200	250	2	2
MSX 14050 ES	□	50	42	50	100	150	3	2
MSX 14050 EM	□	50	42	50	200	250	3	2
14063 ES	□	63	42	50	100	150	4	2
MSX 14063 EM	□	63	42	50	200	250	4	2

## Inserts

Application	Coated Carbide				Dimensions (mm)			Applicable Endmill
	ACP200	ACP300	ACK200	ACK300	IC	S	RE	
High Speed / Light cut	●	●	○	○	6,35	3,0	1,5	MSX06000E□
General Purpose	●	●	○	○	8,5	4,0	2,0	MSX08000E□
Roughing	●	●	○	○	12	5,0	2,0	MSX12000E□
	●	●	○	○	14	6,0	2,0	MSX14000E□

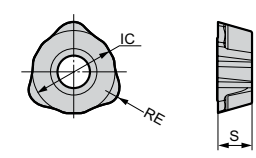

ZDTR-H : Stronger cutting edge

## Spare Parts

Insert Screw	Insert Wrench	Clamp	C Ring	Clamp Screw	Applicable Endmill
BFTX 02505 IP	TRDR 08 IP	-	-	-	MSX 06000E□
BFTX 0306 IP	TRDR 08 IP	-	-	-	MSX 08020E□, MSX 08022E□
BFTX 0306 IP	TRDR 08 IP	CCH 3,5	CR 03	BFTX 03510 IP 08	MSX 08025E□, MSX 08028E□, MSX 08032E□, MSX 08035E□
BFTX 0409 IP	TRDR 15 IP	CCH 3,5	CR 03	BFTX 03510 IP 15	MSX 12000E□
BFTX 0511 IP	TRDR 20 IP	CCH 4,5	CR 03	BFTX 04513 IP 20	MSX 14000E□

# Exchangeable Head Endmills MSX 06000/08000 M

# Exchangeable Head Endmills MSX 08000/12000 M

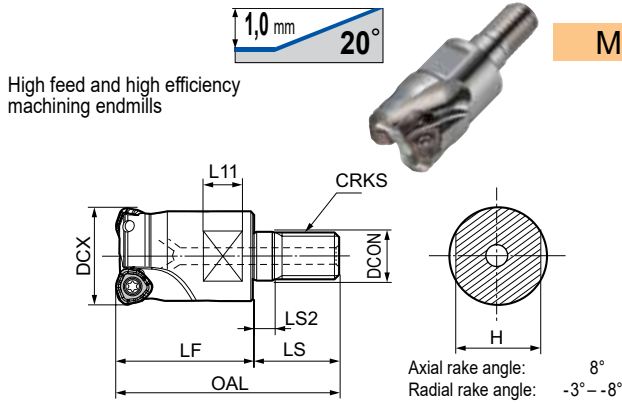

## Modular Type

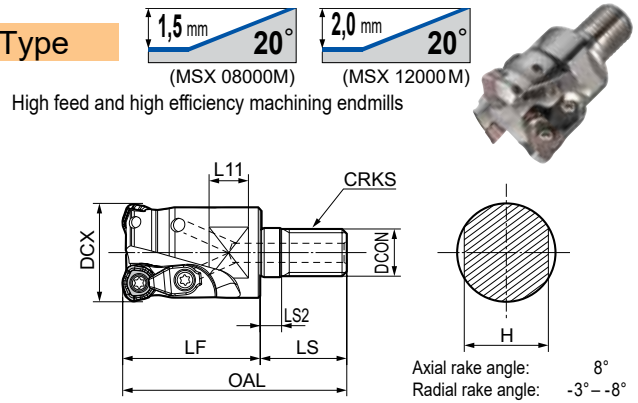

### Heads

For insert type : WDMT 0603

Cat. No.	Stock	Dimensions (mm)									No. of teeth
		DC	DCON	CRKS	OAL	LF	LS2	LS	L11	H	
MSX 06016M08Z2	●	16	8,5	M8	42	25	5	17	8	13	2
06018M08Z2	○	18	8,5	M8	42	25	5	17	8	13	2
MSX 06020M10Z3	●	20	10,5	M10	49	30	5	19	8	15	3
06022M10Z3	□	22	10,5	M10	49	30	5	19	8	15	3
MSX 06025M12Z3	●	25	12,5	M12	56	35	5	21	10	19	3

Inserts are not included.

### Heads

For insert type : WDMT 0804

Cat. No.	Stock	Dimensions (mm)									No. of teeth
		DC	DCON	CRKS	OAL	LF	LS2	LS	L11	H	
MSX 08025M12Z2	●	25	12,5	M12	56	35	5	21	10	19	2
08028M12Z2	□	28	12,5	M12	56	35	5	21	10	19	2
MSX 08030M16Z3	□	30	17,0	M16	63	40	5	23	10	24	3
08032M16Z3	●	32	17,0	M16	63	40	5	23	10	24	3
MSX 08035M16Z3	○	35	17,0	M16	63	40	5	23	10	24	3

Inserts are not included.

### Heads

For insert type : WDMT 1205

Cat. No.	Stock	Dimensions (mm)									No. of teeth
		DC	DCON	CRKS	OAL	LF	LS2	LS	L11	H	
MSX 12032M16Z2	●	32	17,0	M16	63	40	5	23	10	24	2
12035M16Z2	○	35	17,0	M16	63	40	5	23	10	24	2
MSX 12040M16Z3	●	40	17,0	M16	63	40	5	23	10	24	3

Inserts are not included.

### Inserts

Application	Coated Carbide				Dimensions (mm)			Applicable Endmill
	ACP200	ACP300	ACK200	ACK300				
General Purpose	●	●	●	●	IC	S	RE	
Roughing	●	●	●	●				
Cat. No.								
WDMT 0603 ZDTR	●	●	○	●	6,35	3,0	1,5	MSX06000M□
0603 ZDTR-H	●	●	○	●				
WDMT 0804 ZDTR	●	●	○	●	8,5	4,0	2,0	MSX08000M□
0804 ZDTR-H	●	●	○	●				
WDMT 1205 ZDTR	●	●	○	●	12	5,0	2,0	MSX12000M□
1205 ZDTR-H	●	●	○	●				

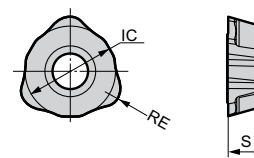

H - Strong Cutting Edge

### Identification Details

<b>MSX</b>	<b>06</b>	<b>016</b>	<b>M08</b>	<b>Z2</b>
Cutter type	Insert size	Diameter	Mounting screw	No. of teeth

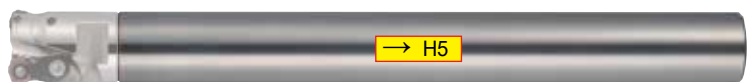

### Spare Parts

Clamp Screw	Insert Wrench	Clamp	C Ring	Insert Screw	Applicable Endmill
BFTX 02505 IP	1,5	TRDR 08 IP	-	-	MSX 06016M - MSX 06025M
BFTX 0306 IP	2,0	TRDR 08 IP	CCH 3,5	CR 03	MSX 08025M - MSX 08035M
BFTX 0409 IP	3,0	TRDR 15 IP	CCH 3,5	CR 03	MSX 12032M - MSX 12040M

# "METAL SLASH MILL" MSX Type

## Recommended Cutting Conditions

Work Material	Coated Carbide Grade	Cutting Speed $v_c$ (m/min)	Insert Cat. No.	Endmill Type ( $\phi$ DC)								Shell Type ( $\phi$ DC)					
				16		20		25		32		40		50-66		80-100	
				$a_p$ (mm)	Feed rate (mm/tooth)	$a_p$ (mm)	Feed rate (mm/tooth)	$a_p$ (mm)	Feed rate (mm/tooth)	$a_p$ (mm)	Feed rate (mm/tooth)	$a_p$ (mm)	Feed rate (mm/tooth)	$a_p$ (mm)	Feed rate (mm/tooth)	$a_p$ (mm)	Feed rate (mm/tooth)
P General Steel (Below HB200)	ACP200	100-150-200	WDMT 0603	0,8	0,8	0,8	0,8	0,8	0,8	-	-	-	-	-	-	-	-
			WDMT 0804	-	-	1,0	1,0	1,0	1,2	1,0	1,2	-	-	-	-	-	-
			WDMT 1205	-	-	-	-	-	-	1,2	1,4	1,2	1,4	1,2	1,4	-	-
			WDMT 1406	-	-	-	-	-	-	-	-	1,5	1,5	1,5	1,5	1,5	1,5
P Alloy Steel (Below HRC45)	ACP200	80-130-180	WDMT 0603	0,7	0,8	0,7	0,8	0,7	0,8	-	-	-	-	-	-	-	-
			WDMT 0804	-	-	0,8	1,0	0,8	1,2	0,8	1,2	-	-	-	-	-	-
			WDMT 1205	-	-	-	-	-	-	1,0	1,4	1,0	1,4	1,0	1,4	-	-
			WDMT 1406	-	-	-	-	-	-	-	-	1,3	1,5	1,3	1,5	1,3	1,5
M Stainless Steel X5CRNi1810, Others	ACP300	80-120-150	WDMT 0603	0,8	0,7	0,8	0,7	0,8	0,7	-	-	-	-	-	-	-	-
			WDMT 0804	-	-	1,0	0,8	1,0	0,8	1,0	0,8	-	-	-	-	-	-
			WDMT 1205	-	-	-	-	-	-	1,2	1,2	1,2	1,2	1,2	1,2	-	-
			WDMT 1406	-	-	-	-	-	-	-	-	1,5	1,3	1,5	1,3	1,5	1,3
K Cast Iron GG, GGG	ACK300	100-150-200	WDMT 0603	0,8	1,0	0,8	1,0	0,8	1,0	-	-	-	-	-	-	-	-
			WDMT 0804	-	-	1,0	1,2	1,0	1,4	1,0	1,4	-	-	-	-	-	-
			WDMT 1205	-	-	-	-	-	-	1,2	1,5	1,2	1,5	1,2	1,5	-	-
			WDMT 1406	-	-	-	-	-	-	-	-	1,5	1,8	1,5	1,8	1,5	1,8
H Hardened Steel (Below HRC50)	ACK300	40-80-100	WDMT 0603	0,5	0,5	0,5	0,5	0,5	0,5	-	-	-	-	-	-	-	-
			WDMT 0804	-	-	0,5	0,6	0,5	0,8	0,5	0,8	-	-	-	-	-	-
			WDMT 1205	-	-	-	-	-	-	0,6	1,0	0,6	1,0	0,6	1,0	-	-
			WDMT 1406	-	-	-	-	-	-	-	-	1,0	1,2	1,0	1,2	1,0	1,2

Insert Cat. No.	Max $a_p$	RE
WDMT 0603....	1,0	1,5
WDMT 0804....	1,5	2,0
WDMT 1205....	2,0	2,0
WDMT 1406....	2,5	2,0

- The above recommended cutting conditions may require adjustment according to machine rigidity and work rigidity. The above figures are guidelines for use with the BT50 machine tool.
- The above cutting conditions assume a tool overhang length of  $L/D = 3$  (i.e. overhang length is 3 times tool diameter) or less. When tool overhang is **more than  $L/D = 3$  and less than or equal  $L/D = 5$** , settings should be adjusted to approximately **70 to 80 %** of those indicated in the above cutting conditions (i.e.  $a_p$  and Feed Rate). When tool overhang is **more than  $L/D = 5$  and less than or equal  $L/D = 8$** , settings should be adjusted to approximately **50 to 60 %** of those indicated in the above cutting conditions (i.e.  $a_p$  and Feed Rate).

## Information for Programming

For machine programming, please use the theoretical corner radius (R) shown in the list.

Maximum depth (d) between theoretical radius and actual profile will be left on the finished surface, as shown below.

	Body	Insert	Theoretical Radius (R)	Remaining Depth (d)
	MSX 06000	WDMT 0603....	2,0	0,403
	MSX 08000	WDMT 0804....	2,5	0,593
	MSX 12000	WDMT 1205....	3,0	1,030
	MSX 14000	WDMT 1406....	3,5	1,219

## Plunging and Helical Boring

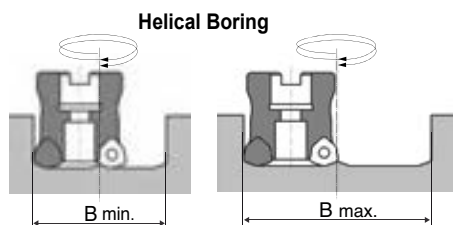
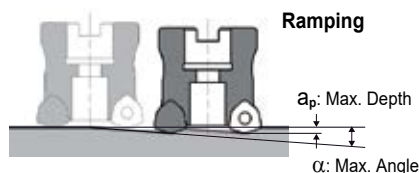

Cutter $\phi$	WDMT0603ZDTR			WDMT0804ZDTR			WDMT1205ZDTR			WDMT1406ZDTR		
	$a_p$ : max 1,0			$a_p$ : max 1,5			$a_p$ : max 2,0			$a_p$ : max 2,5		
	Ramping $\alpha$ max.	Helical boring min. $\phi B$	max. $\phi B$	Ramping $\alpha$ max.	Helical boring min. $\phi B$	max. $\phi B$	Ramping $\alpha$ max.	Helical boring min. $\phi B$	max. $\phi B$	Ramping $\alpha$ max.	Helical boring min. $\phi B$	max. $\phi B$
16	6°00'	21	31									
17	5°00'	23	33									
18	4°30'	25	35									
20	3°30'	29	39	7°30'	25	38						
22	3°00'	33	43	5°30'	29	42						
25	2°00'	39	48	4°00'	35	48						
28				3°00'	41	54						
32				2°30'	49	62	6°30'	42	63			
35				2°00'	55	68	5°00'	48	69			
40				1°30'	65	78	4°00'	58	79	6°00'	53	78
50							2°30'	78	99	3°30'	73	98
63							2°00'	103	124	2°00'	99	124
66							1°30'	109	130	1°45'	105	130
80										1°30'	133	158
100										1°00'	173	198



### General Features

WaveMill WFXH type is a high efficiency, multi-purpose cutter, that uses the WFX series inserts for high-feed roughing and a variety of processes.

### Characteristics

Stable, high-efficiency milling with superior cutting edge sharpness. Supports various types of processes (ramping and helical milling). Able to use the selection of inserts from the WFX series.

### Notes on Corner Finishing - Remaining Material

Actual machined corners will have uncut and overcut portions due to the shape of the inserts.

Fig. 1

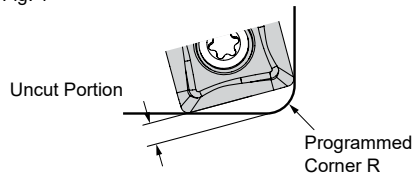
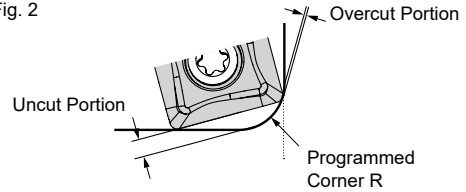

Fig. 2



### WFXH 08000 Type

Programmed Corner R	SOMT 080004-□			SOMT 080008-□			SOMT 080012-□		
	Uncut Portion	Overcut Portion	Shape	Uncut Portion	Overcut Portion	Shape	Uncut Portion	Overcut Portion	Shape
2,0	1,41	0	Fig. 1	1,30	0	Fig. 1	1,21	0	Fig. 1
2,5	1,30	0,02	Fig. 2	1,19	0,01	Fig. 2	1,09	0	Fig. 2
3,0	-	-	-	-	-	-	0,98	0,05	Fig. 2

### WFXH 12000 Type

Programmed Corner R	SOMT 120004-□			SOMT 120008-□			SOMT 120012-□			SOMT 120016-□		
	Uncut Portion	Overcut Portion	Shape	Uncut Portion	Overcut Portion	Shape	Uncut Portion	Overcut Portion	Shape	Uncut Portion	Overcut Portion	Shape
2,0	2,58	0	Fig. 1	2,48	0	Fig. 1	2,37	0	Fig. 1	2,25	0	Fig. 1
2,5	2,47	0	Fig. 1	2,37	0	Fig. 1	2,25	0	Fig. 1	2,14	0	Fig. 1
3,0	2,36	0	Fig. 1	2,26	0	Fig. 1	2,14	0	Fig. 1	2,11	0	Fig. 1
3,5	2,24	0,01	Fig. 2	2,14	0	Fig. 1	2,03	0	Fig. 1	1,91	0	Fig. 1
4,0	-	-	-	2,03	0,04	Fig. 2	1,91	0,03	Fig. 2	1,8	0,01	Fig. 2

### Minimum Cutting Diameter

Minimum cutting diameter (DCN) will depend on the insert that is used. Using an insert with a large nose radius is recommended for the WFXH type.

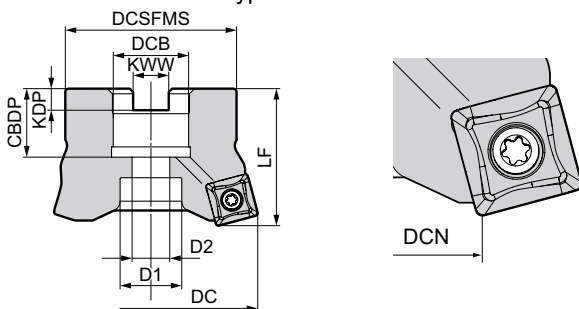

Body Cat. No.	DC	DCN based on insert nose			
		R0,4	R0,8	R1,2	R1,6
WFXH 08025 M	25	9,69	9,48	9,27	-
08032 M	32	16,6	16,4	16,2	-
WFXH 12040 M	40	15,8	15,5	15,3	15,1

### Taper Cutting and Helical Milling

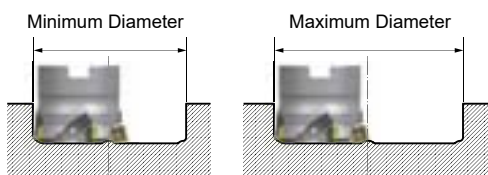

Minimum and Maximum Diameters

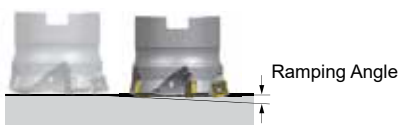

Ramping Angle

Insert Cat. No.	DC	Helical Milling		Taper Cutting
		Min.	Max.	Max. Ramping Angle
SOMT 080004-□	25	35	49	1°30'
	32	49	63	0°30'
SOMT 080008-□	25	35	48	3°
	32	49	62	1°30'
SOMT 080012-□	25	34	47	4°30'
	32	48	61	2°30'
SOMT 120004-□	40	56	79	1°
SOMT 120008-□	40	56	78	1°30'
SOMT 120012-□	40	55	77	2°30'
SOMT 120016-□	40	55	76	3°30'

● = Euro stock  
○ = Japan stock

→ G68-G71

Recommended Tightening Torque (N·m)



# "Wave Mill" Series

## WFXH 08000/12000 M

Expansion

### Modular Type

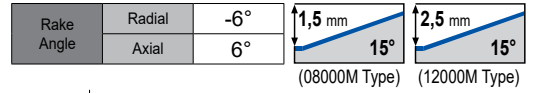
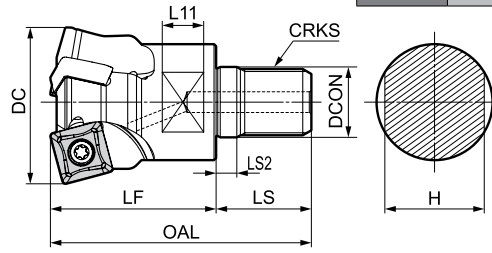

### Head

Cat. No.	Stock	Dimensions (mm)									No. of Teeth	Weight (kg)
		DC	DCON	CRKS	OAL	LF	LS2	LS	L11	H		
WFXH08025M12Z2	○	25	12,5	M12	56	35	5	21	10	19	2	0,1
08032M12Z3	○	32	17,0	M16	63	40	5	23	10	24	3	0,2

Inserts are not included.

### Identification Details

WFX	08	020	M10	Z2
Cutter Series	Insert Size	Cutter Diameter	Screw Size	No. of Teeth

### Head

Cat. No.	Stock	Dimensions (mm)									No. of Teeth	Weight (kg)
		DC	DCON	CRKS	OAL	LF	LS2	LS	L11	H		
WFXH12040M12Z3	○	40	17,0	M16	63	40	5	23	10	24	3	0,2

Inserts are not included.

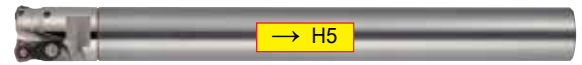

### Inserts

Application	Coated Carbide										Carbide	DLC	Cermet		
	ACU2500	XCU2500	ACP100	ACP200	ACP300	XCU2000	ACK200	ACK300	ACM200	ACM300	H1	DL1000	T4500Z	RE	Fig.
High Speed / Light cut	●	●	●	●	●	●	●	●	●	●	●	●	●	●	
General Purpose	●	●	●	●	●	●	●	●	●	●	●	●	●	●	
Roughing	●	●	●	●	●	●	●	●	●	●	●	●	●	●	
Cat. No.															
SOMT 080304 PZER L	●	○	●	●	○	○	○	●	●	●	●	●	●	0,4	1
080308 PZER L	●	○	○	●	●	●	●	●	●	●	●	●	●	0,8	1
SOMT 080304 PZER G	●	○	●	●	●	○	○	●	●	●	●	●	●	0,4	1
080308 PZER G	●	○	●	●	●	○	○	●	●	●	●	●	●	0,8	1
080312 PZER G	●	○	●	●	●	○	○	●	●	●	●	●	●	1,2	1
SOMT 080308 PZER H	●	○	●	●	●	○	○	●	●	●	●	●	●	0,8	1
080312 PZER H	●	○	●	●	●	○	○	●	●	●	●	●	●	1,2	1
SOET 080304 PZER G	●	○	○	○	○	○	○	○	○	○	○	○	○	0,4	1
080308 PZER G	●	○	○	○	○	○	○	○	○	○	○	○	○	0,8	1
080312 PZER G	●	○	○	○	○	○	○	○	○	○	○	○	○	1,2	1
SOET 080302 PZFR S	-	-	-	-	-	-	-	-	-	-	●	●	●	0,2	1
080304 PZFR S	-	-	-	-	-	-	-	-	-	-	●	●	●	0,4	1
080308 PZFR S	-	-	-	-	-	-	-	-	-	-	●	●	●	0,8	1
SOMT 120408 PDER L	●	○	●	●	●	○	○	●	●	●	●	●	●	0,8	2
SOMT 120404 PDER G	●	○	○	●	●	○	○	●	●	●	●	●	●	0,4	2
120408 PDER G	●	○	●	●	●	○	○	●	●	●	●	●	●	0,8	2
120412 PDER G	●	○	○	●	●	○	○	●	●	○	○	○	○	1,2	2
120416 PDER G	●	○	○	●	●	○	○	●	●	○	○	○	○	1,6	2
SOMT 120408 PDER H	●	○	●	●	●	○	○	●	●	●	●	●	●	0,8	2
SOET 120408 PDFR S	-	-	-	-	-	-	-	-	-	-	●	●	●	0,8	2

Fig. 1

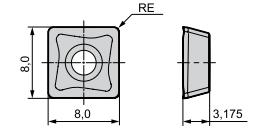
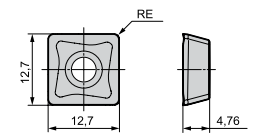

Fig. 2



### Spare Parts

Applicable Cutter	Screw	Insert Wrench
	WFXH08000M	BFTX0306IP 2,0
WFXH12000M	BFTX03512IP 3,0	TRDR15IP

### Recommended Cutting Conditions

ISO	Work Material	Grade	Cutting Speed (v <sub>c</sub> (m/min))	Insert Cat. No.	Ø 25		Ø 32		Ø 40		Ø 50		Ø 63	
					a <sub>p</sub> (mm)	f <sub>z</sub> (mm/t)	a <sub>p</sub> (mm)	f <sub>z</sub> (mm/t)	a <sub>p</sub> (mm)	f <sub>z</sub> (mm/t)	a <sub>p</sub> (mm)	f <sub>z</sub> (mm/t)	a <sub>p</sub> (mm)	f <sub>z</sub> (mm/t)
P	General Steel <200HB	ACP200	100-150-200	SOMT08	0,8	0,8	0,8	0,8	0,8	0,8	0,8	0,8	0,8	0,8
				SOMT12	-	-	-	-	1,0	1,0	-	-	-	-
M	Alloy Steel <HRC45	ACP200	80-130-180	SOMT08	0,7	0,8	0,7	0,8	0,7	0,8	0,7	0,8	0,7	0,8
				SOMT12	-	-	-	-	0,8	1,0	0,8	1,0	0,8	1,0
K	Stainless Steel (X5CrNiS18 10, other)	ACM300	80-120-150	SOMT08	0,8	0,7	0,8	0,7	0,8	0,7	0,8	0,7	0,8	0,7
				SOMT12	-	-	-	-	1,0	0,8	1,0	0,8	1,0	0,8
H	Cast Iron FC, FCD	ACK300	100-150-200	SOMT08	0,8	1,0	0,8	1,0	0,8	1,0	0,8	1,0	0,8	1,0
				SOMT12	-	-	-	-	1,0	1,2	1,0	1,2	1,0	1,2
H	Hardened Steel <HRC50	ACK300	40-80-100	SOMT08	0,5	0,5	0,5	0,5	0,5	0,5	0,5	0,5	0,5	0,5
				SOMT12	-	-	-	-	0,6	0,8	0,6	0,8	0,6	0,8

The above recommended cutting conditions may require adjustment according to machine rigidity and work rigidity. The above figures are guidelines for use with the BT50 machine tool.

The above conditions assume a tool overhang length of L/D = 3 (i.e. overhang length is 3 times tool diameter) or less.

When tool overhang is more than L/D = 3 and less or equal L/D = 5, settings should be adjusted to approximately 70 % to 80 % of those indicated in the above cutting conditions (i.e. a<sub>p</sub> and f<sub>z</sub>).

When tool overhang is more than L/D = 5 and less or equal L/D = 8, settings should be adjusted to approximately 50 % to 60 % of those indicated in the above cutting conditions (i.e. a<sub>p</sub> and f<sub>z</sub>).



# "Sumi Dual Mill" DFC Type

Expansion

## General Features

The Sumi Dual Mill DFC type employs cost effective double-sided inserts for high toughness and enhanced accuracy.  
The double-side inserts are flexible and reduces costs.

## Large Line-up

- Diameter from  $\varnothing$  25 mm to  $\varnothing$  200 mm
- Available as standard, fine and extra-fine pitch
- Bore diameter: metric
- Insert geometry: L, G, GS, H



## Cutter Body

Type	Cat. No.	Diameter (mm)	No. of Teeth	Image
Shank	Standard Pitch	DFC 09000 E	$\varnothing$ 25 – $\varnothing$ 80	
	Fine Pitch	DFCM 09000 E	$\varnothing$ 32 – $\varnothing$ 80	
Shell	Standard Pitch	DFC 09000 RS	$\varnothing$ 50 – $\varnothing$ 200	
	Fine Pitch	DFCM 09000 RS	$\varnothing$ 50 – $\varnothing$ 200	
	→G22-G25 Extra-Fine Pitch	DFCF 09000 RS	$\varnothing$ 50 – $\varnothing$ 200	

## New Insert Design Provides Excellent Machining Accuracy

### Inserts

Cat. No.	RE0,4	RE0,8	RE1,2	RE1,6
XNMMU0606__PNER-L	●	●		
XNMMU0606__PNER-G	●	●	●	●
XNMMU0606__PNER-GS	●	●	●	●
XNMMU0606__PNER-H		●	●	●

### Chipbreaker Selection Map

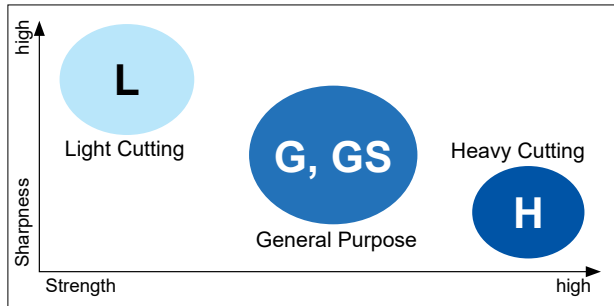

Work Material	P M K S			
	L type	G type	GS type	H type
Chipbreaker				
Applications	Light cutting	General purpose to interrupted milling	Shoulder milling	Heavy cutting
Cutting edge geometry				
Features	Low rigidity milling, reduction of burrs	Face milling	Shoulder milling	Roughing, heavy interrupted and hardness steel milling

## Stable and High Cutting Performance Combined with High Toughness

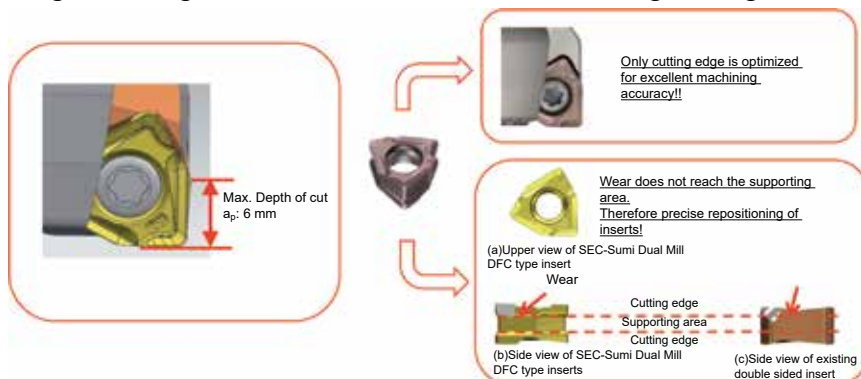



# "Sumi Dual Mill" DFC(M) 09000 E

## Body – Shank Type



Rake Angle	Radial	-9°
	Axial	-5°

Max. a<sub>p</sub>: 6 mm

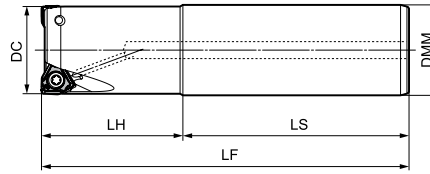

## Body – Dimensions

### ● DFC type, Standard Pitch

Cat. No.	Stock	Dimensions (mm)					No. of Teeth
		DC	DMM	LH	LS	LF	
DFC 09025E	●	25	25	40	80	120	2
DFC 09032E	●	32	32	50	80	130	2
09040E	●	40	32	50	80	130	3
09050E	●	50	32	50	80	130	3
DFC 09050E-42	●	50	42	50	100	150	3
DFC 09063E	●	63	32	50	80	130	4
DFC 09063E-42	●	63	42	50	100	150	4
DFC 09080E	●	80	32	50	80	130	5
DFC 09080E-42	●	80	42	50	100	150	5

### ● DFCM type, Medium Pitch

Cat. No.	Stock	Dimensions (mm)					No. of Teeth
		DC	DMM	LH	LS	LF	
DFCM 09032E	●	32	32	50	80	130	3
09040E	●	40	32	50	80	130	4
09050E	●	50	32	50	80	130	5
DFCM 09050E-42	●	50	42	50	100	150	5
DFCM 09063E	●	63	32	50	80	130	6
DFCM 09063E-42	●	63	42	50	100	150	6
DFCM 09080E	●	80	32	50	80	130	7
DFCM 09080E-42	●	80	42	50	100	150	7

## Identification Details

**DFC**      **M**      **09**      **050**      **E**  
 Cutter Series      M: Medium Insert Size      Cutter Diameter      Shank Type

## Inserts

Application	Coated Carbide								RE		
High Speed / Light Cutting											
General Purpose Cutting											
Rough Cutting											
Cat. No.	ACU2500	XCU2500	ACP100	ACP200	ACP300	XCK2000	ACK200	ACK300	ACM200	ACM300	
XNMMU 060604 PNER-L	●	○	●	●	●	○	●	●	●	●	0,4
060608 PNER-L	●	○	●	●	●	○	●	●	●	●	0,8
XNMMU 060604 PNER-G	●	○	●	●	●	○	●	●	●	●	0,4
060608 PNER-G	●	○	●	●	●	○	●	●	●	●	0,8
060612 PNER-G	●	○	●	●	●	○	●	●	●	●	1,2
060616 PNER-G	●	○	●	●	●	○	●	●	●	●	1,6
XNMMU 060604 PNER-GS	○	○	●	●	●	○	○	○	○	○	0,4
060608 PNER-GS	○	○	●	●	●	○	○	○	○	○	0,8
060612 PNER-GS	○	○	○	○	○	○	○	○	○	○	1,2
060616 PNER-GS	○	○	○	○	○	○	○	○	○	○	1,6
XNMMU 060608 PNER-H	●	○	●	●	●	○	●	●	●	●	0,8
060612 PNER-H	●	○	●	●	●	○	●	●	●	●	1,2
060616 PNER-H	●	○	●	●	●	○	●	●	●	●	1,6

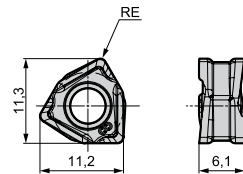

## Spare Parts

Screw	Wrench
BFTX03512IP	TRDR15IP 5,0

## Recommended Cutting Conditions

ISO	Work-material	Hardness (HB)	Cutting Speed (m/min)	Feed Rate	Depth of Cut (mm)	Grade
<b>P</b>	General Steel	180–280	150–200–250	0,10–0,20–0,30	< 6	ACU2500
	Soft Steel	≤180	180–250–350	0,15–0,25–0,35	< 6	ACP200
	Die Steel	200–220	100–150–200	0,10–0,18–0,25	< 4	ACP300
<b>M</b>	Stainless Steel	–	160–205–250	0,12–0,18–0,25	< 6	XCU2500
<b>K</b>	Cast Iron	250	100–175–250	0,10–0,20–0,30	< 6	ACU2500
<b>S</b>	Exotic Alloy	–	30–50–80	0,10–0,20–0,30	< 6	ACK200
						ACK300
						XCU2500
						XCK2000
						ACU2500
						ACM200
						ACM300

## Applications and Recommended Chipbreakers

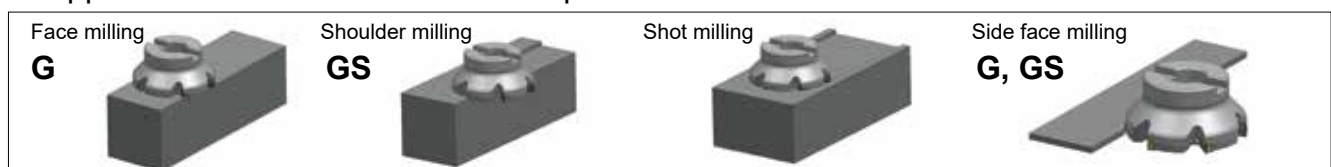

# "Sumi Wave" Shoulder Mill WFX (M) 08000 E

Expansion

# "Sumi Wave" Shoulder Mill WFX 08000 M

## Body - Shank Type

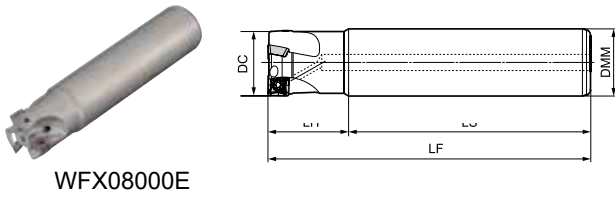

WFX08000E

## Modular Type

Rake Angle	Radial	-6°	6mm	90°
	Axial	12°		

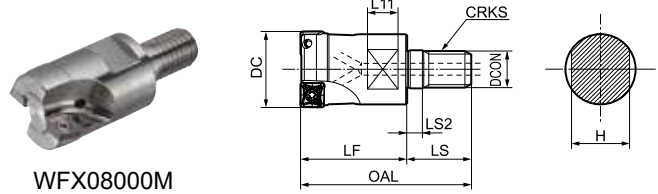

WFX08000M

## Body - WFX\_E, Standard Pitch

Cat. No.	Stock	Dimensions (mm)					No. of Teeth
		DC	DMM	LH	LS	LF	
WFX 08020 E-16	●	20	16	30	80	110	2
WFX 08020 E	●	20	20	30	80	110	2
08022 E	●	22	20	30	90	120	2
WFX 08025 E-20	●	25	20	30	90	120	2
WFX 08025 E	●	25	25	30	90	120	2
08028 E	●	28	25	30	90	120	2
08030 E	●	30	25	30	90	120	3
WFX 08032 E	●	32	32	30	90	120	3
08033 E	●	33	32	30	90	120	3
08040 E	●	40	32	30	90	120	3
08050 E	●	50	32	30	90	120	4
08063 E	●	63	32	30	90	120	5

Inserts are not included.

## Body - WFXM\_E, Medium Pitch

Cat. No.	Stock	Dimensions (mm)					No. of Teeth
		DC	DMM	LH	LS	LF	
WFXM 08025 E	●	25	25	30	90	120	3
WFXM 08032 E	●	32	32	30	90	120	4
08040 E	●	40	32	30	90	120	4
08050 E	●	50	32	30	90	120	5
08063 E	●	63	32	30	90	120	6

Inserts are not included.

## Identification Details

<b>WFX</b>	<b>M</b>	<b>08</b>	<b>025</b>	<b>E</b>
Cutter Series	M: Medium	Insert Size	Cutter Diameter	Endmill Type

## Recommended Cutting Conditions

ISO	Work Material	Hardness (HB)	Cutting Speed	Feed Rate	DOC	Grades
P	General Steel	180-280	150-200-250	0,08-0,12-0,18	<6	ACU2500 ACP200 ACP300
	Soft Steel	≤180	180-250-350	0,10-0,15-0,20	<6	XCU2500
	Die Steel	200-220	100-150-200	0,08-0,12-0,18	<4	XCU2500
M	Stainless Steel	-	160-200-250	0,10-0,15-0,20	<6	ACU2500 ACM300
K	Cast Iron	250	100-175-250	0,10-0,15-0,20	<6	ACU2500 ACK200 ACK300 XCU2500 XCK2000
N	Non Ferrous Metal	-	300-500-1000	0,10-0,15-0,20	<6	H1 DL1000
S	Exoric Alloy	-	30-50-80	0,08-0,13-0,18	<6	ACU2500 ACM200 ACM300

Min. - Optimum - Max.

## Head

Cat. No.	Stock	Dimensions (mm)										No. of Teeth
		DC	DCON	CRKS	OAL	LF	LS2	LS	L11	H		
WFX 08020 M10Z2	●	20	10,5	M10	49	30	5	19	8	15	2	
08022 M10Z2	●	22	10,5	M10	49	30	5	19	8	15	2	
WFX 08025 M12Z2	●	25	12,5	M12	56	35	5	21	10	19	2	
08028 M10Z2	●	28	12,5	M12	56	35	5	21	10	19	2	
WFX 08030 M16Z3	●	30	17,0	M16	63	40	5	23	10	24	3	
08032 M16Z3	●	32	17,0	M16	63	40	5	23	10	24	3	
08040 M16Z3	●	40	17,0	M16	63	40	5	23	10	24	3	

## Identification Details

<b>WFX</b>	<b>08</b>	<b>020</b>	<b>M10</b>	<b>Z2</b>
Cutter Series	Insert Size	Cutter Diameter	Screw Size	No. of Teeth

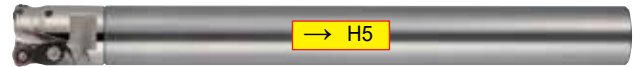

## Inserts

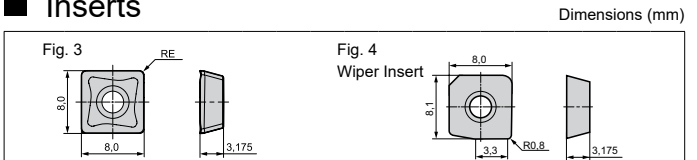

Application	Coated Carbide										Carbide	DLC			
	ACU2500	XCU2500	ACP100	ACP200	ACP300	XCK2000	ACK200	ACK300	ACM200	ACM300			H1	DL1000	
High Speed / Light cut	●	●	●	●	●	●	●	●	●	●	●	●	●	●	
General Purpose	●	●	●	●	●	●	●	●	●	●	●	●	●	●	
Roughing	●	●	●	●	●	●	●	●	●	●	●	●	●	●	
Cat. No.	ACU2500	XCU2500	ACP100	ACP200	ACP300	XCK2000	ACK200	ACK300	ACM200	ACM300	H1	DL1000	RE	Fig.	
SOMT 080304 PZER L	●	○	○	○	○	○	○	○	○	○	○	○	-	0,4	3
080308 PZER L	●	○	○	○	○	○	○	○	○	○	○	○	-	0,8	3
SOMT 080304 PZER G	●	○	○	○	○	○	○	○	○	○	○	○	-	0,4	3
080308 PZER G	●	○	○	○	○	○	○	○	○	○	○	○	-	0,8	3
080312 PZER G	●	○	○	○	○	○	○	○	○	○	○	○	-	1,2	3
SOMT 080308 PZER H	●	○	○	○	○	○	○	○	○	○	○	○	-	0,8	3
080312 PZER H	●	○	○	○	○	○	○	○	○	○	○	○	-	1,2	3
SOET 080304 PZER G	●	○	○	○	○	○	○	○	○	○	○	○	-	0,4	3
080308 PZER G	●	○	○	○	○	○	○	○	○	○	○	○	-	0,8	3
080312 PZER G	●	○	○	○	○	○	○	○	○	○	○	○	-	1,2	3
SOET 080302 PZFR S	-	-	-	-	-	-	-	-	-	-	●	●	0,2	3	
080304 PZFR S	-	-	-	-	-	-	-	-	-	-	●	●	0,4	3	
080308 PZFR S	-	-	-	-	-	-	-	-	-	-	●	●	0,8	3	
XOEW 080308 PZTR W	●	-	-	-	-	-	-	-	-	-	-	-	-	0,8	4

## Spare Parts

Screw	Wrench
BFTX0306IP	TRDR08IP
(N·m)	
2,0	

Recommended Tightening Torque (N·m)

## Body - Shank Type

Rake Angle	Radial	-8°	10 mm	90°
	Axial	8°		

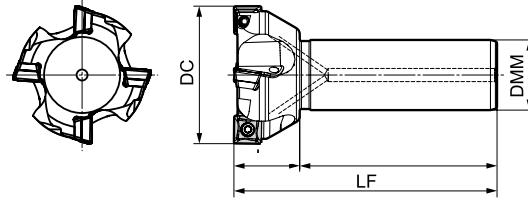

## Body - WFX\_E, Standard Pitch

Cat. No.	Stock	Dimensions (mm)					No. of Teeth
		DC	DMM	LH	LS	LF	
WFX 12040 E	●	40	32	30	90	120	3
12050 E	●	50	32	30	90	120	3
12063 E	●	63	32	30	90	120	4
12080 E	●	80	32	30	90	120	4

Inserts are not included.

## Body - WFXF\_E, Fine Pitch

Cat. No.	Stock	Dimensions (mm)					No. of Teeth
		DC	DMM	LH	LS	LF	
WFXF 12050 E	●	50	32	30	90	120	4
12063 E	●	63	32	30	90	120	5
12080 E	●	80	32	30	90	120	6

Inserts are not included.

## Identification Details

<b>WFX</b>	<b>F</b>	<b>12</b>	<b>050</b>	<b>E</b>
Cutter Series	F: Fine	Insert Size	Cutter Diameter	Endmill Type

## Recommended Cutting Conditions

ISO	Work Material	Hardness (HB)	Cutting Speed	Feed Rate	DOC	Grades
P	General Steel	180-280	150-200-250	0,10-0,15-0,20	<10	ACU2500 ACP200 ACP300
	Soft Steel	≤180	180-250-350	0,10-0,15-0,20	<10	
	Die Steel	200-220	100-150-200	0,10-0,15-0,20	<6	XCU2500
M	Stainless Steel	-	160-200-250	0,10-0,15-0,20	<10	ACU2500 ACM300
K	Cast Iron	250	100-175-250	0,10-0,15-0,20	<10	ACU2500 ACK200 ACK300 XCU2500 XCK2000
N	Non Ferrous Metal	-	300-500-1000	0,10-0,15-0,20	<10	H1 DL1000
S	Exoric Alloy	-	30-50-80	0,10-0,15-0,20	<10	ACU2500 ACM200 ACM300

Min. - Optimum - Max.

## Inserts

Application	Coated Carbide										Carbide		DLC	
	ACU2500	XCU2500	ACP100	ACP200	ACP300	XCK2000	ACK200	ACK300	ACM200	ACM300	H1	DL1000	RE	Fig.
High Speed / Light cut	●	●	●	●	●	●	●	●	●	●	●	●	●	●
General Purpose	●	●	●	●	●	●	●	●	●	●	●	●	●	●
Roughing	●	●	●	●	●	●	●	●	●	●	●	●	●	●
Cat. No.	ACU2500	XCU2500	ACP100	ACP200	ACP300	XCK2000	ACK200	ACK300	ACM200	ACM300	H1	DL1000	RE	Fig.
SOMT 120408 PDER L	●	○	●	●	●	○	●	●	●	●	●	●	●	0,8 3
SOMT 120404 PDER G	●	○	○	●	●	○	●	●	●	●	●	●	●	0,4 3
120408 PDER G	●	○	○	●	●	○	●	●	●	●	●	●	●	0,8 3
120412 PDER G	●	○	○	●	○	○	●	○	○	○	○	○	○	1,2 3
120416 PDER G	●	○	●	●	●	○	○	○	○	○	○	○	○	1,6 3
SOMT 120408 PDER H	●	○	●	●	●	○	●	●	●	●	●	●	●	0,8 3
SOET 120408 PDFR S	-	-	-	-	-	-	-	-	-	-	-	●	●	0,8 3
XOEW 120408 PDTR W	○	-	-	-	-	-	-	-	-	-	-	-	-	4

## Spare Parts

Shim	Shim Screw	Insert Screw	Insert Wrench	Seat Wrench
WFXS4R	BW0507F	BFTX03512IP	3,0	TRDR15IP
				LH035

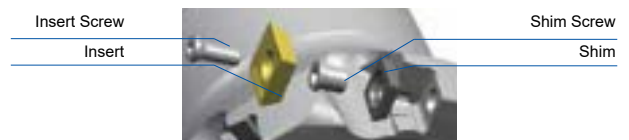



## General Features



High-efficient and high precision tangential shoulder milling cutter with tangentially mounted carbide inserts.

## Characteristics

- Tough & Sharp cutting edge
- Very accurate and excellent surface finish
- Wide product range



## Product Range

### TSX Shoulder Milling Cutter

	Cat. No.	Series	Diameter Range / No of Teeth													Shape		
			Ø16	Ø20	Ø25	Ø32	Ø40	Ø50	Ø63	Ø80	Ø100	Ø125	Ø160	Ø200	Ø250		Ø315	
Shell Type	TSX 08000RS	Standard Pitch					4	5	6	7								 → G30-G37
	TSXF 08000RS	Fine Pitch					6	8	10	11								
	TSX 13000RS	Standard Pitch					3	4	5	5	6	7	8	12	14	16		
	TSXM 13000RS	Medium Pitch					4	5	6	7	8	10	12	16	20	24		
	TSXF 13000RS	Fine Pitch					5	6	7	8	10	14	16					
Shank Type	TSX 08000E	Standard Pitch	2	2*	3*	3*	4	5	6	7								
	TSXF 08000E	Fine Pitch		3	4	5	6	8	10	11								
	TSX 13000E	Standard Pitch			2	2	3	4	5	5								
	TSXM 13000E	Medium Pitch				3	4	5	6	7								
	TSXF 13000E	Fine Pitch					5	6	7	8								

\* Different shank diameters in stock

### TSXR Repeater







Type	Cat. No.	Diameter Range / No of Teeth											Shape			
		Ø16	Ø20	Ø25	Ø32	Ø40	Ø50	Ø63	Ø80	Ø100	Ø125					
Shell	TSXR 08000RS				2	3	3	4	5							 → G38-G39
	TSXR 13000RS					2	3		3	4	4	5	5	6	7	
Shank	TSXR 08000E		1	2	2	3										
	TSXR 13000E					2	3									

## Recommended Cutting Conditions

Min. - Optimum - Max.

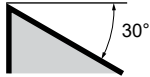
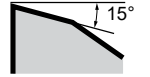
ISO	Work-material	Hardness (HB)	Cutting Speed $v_c$ (m/min)	TSX ___ E		Grade
				Feed Rate $f_t$ (mm/T)		
P	Carbon Steel	180–280	150– <b>225</b> –300	0,08– <b>0,20</b> –0,30		ACU2500 ACP100 ACP200 ACP300 XCU2500
		> 280	75– <b>150</b> –230	0,08– <b>0,20</b> –0,30		
	Alloy Steel	180–280	100– <b>175</b> –250	0,08– <b>0,15</b> –0,25		
M	Stainless Steel	220–280	90– <b>135</b> –180	0,08– <b>0,15</b> –0,25		ACU2500 ACM200 ACM300
		>280	75– <b>125</b> –170	0,08– <b>0,15</b> –0,25		
K	Cast Iron Ductile Cast Iron	250	100– <b>175</b> –250	0,08– <b>0,20</b> –0,30		ACU2500 ACK200 ACK300 XCU2500 XCK2000
S	Exotic Material	–	30– <b>60</b> –90	0,05– <b>0,10</b> –0,15		ACU2500 ACM200 ACM300

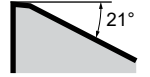
## ■ Chipbreaker Lineup

Work Material	P M K S		
	L type	G type	H type
Chipbreaker			
Feature	Low cutting force	General purpose	Strong edge
LNEX08 Cutting edge geometry			—
LNEX13 Cutting edge geometry			
Application	Light cut, low rigidity milling and reduced burrs	Main breaker for general purpose applications	Roughing, heavy interrupted and hardness steel milling

## ■ Chipbreaker Selection

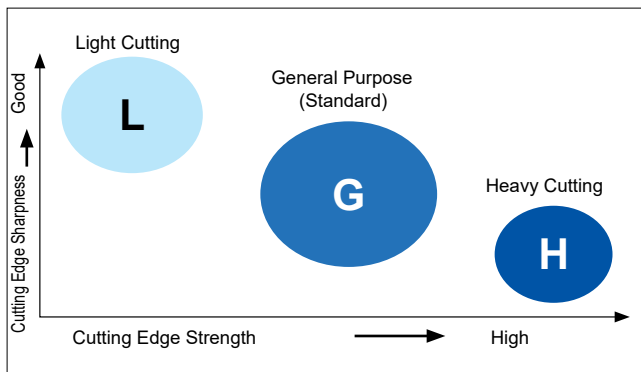

## ■ Inserts

Cat. No.	RE0,4	RE0,8	RE1,2	RE1,6	RE2,4	RE3,2
LNEX0804__PNER-L	●	●				
LNEX0804__PNER-G	●	●	●	●		
LNEX1306__PNER-L	●	●				
LNEX1306__PNER-G		●		●	●	●
LNEX1306__PNER-H	●	●		●	●	●

## ■ Suitable Applications

Face milling

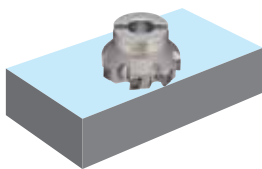

Shoulder milling

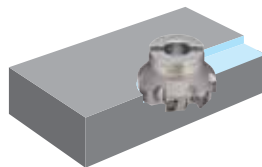

Side face milling

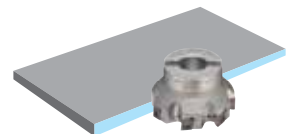

Slot milling

Recommended  
≤ ø32 mm

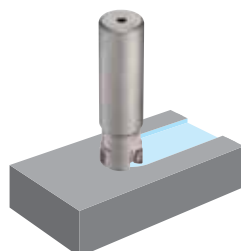

Hole expansion milling

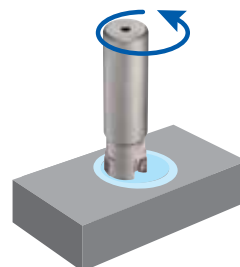



# "Sumi Dual Mill" Series TSX(F) 08000 E

Expansion

## Shank Type

Rake Angle	Radial	-36° ~ -20°	8 mm	90°
	Axial	-6°		

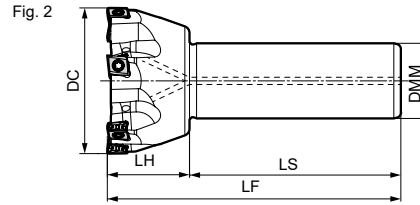
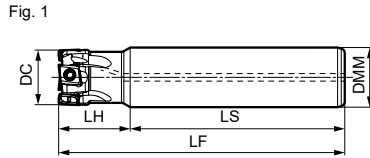

## Body - TSX, Standard Pitch

Cat. No.	Stock	Dimensions (mm)					No. of Teeth	Weight (kg)	Figure
		DC	DMM	LH	LS	LF			
TSX 08016 E	●	16	16	25	75	100	2	0,13	1
08020 E	●	20	20	30	80	110	2	0,22	1
08020 E-16	○	20	16	30	80	110	2	0,15	2
08025 E	●	25	25	30	90	120	3	0,40	1
08025 E-20	○	25	20	30	90	120	3	0,26	2
08032 E	●	32	32	30	90	120	3	0,67	1
08032 E-25	○	32	25	30	90	120	3	0,43	2
08040 E	●	40	32	30	90	120	4	0,72	2
08050 E	○	50	32	30	90	120	5	0,85	2
08063 E	○	63	32	35	90	125	6	1,09	2
08080 E	○	80	32	35	90	125	7	1,44	2

Inserts are not included.

## Body - TSXF, Fine Pitch

Cat. No.	Stock	Dimensions (mm)					No. of Teeth	Weight (kg)	Figure
		DC	DMM	LH	LS	LF			
TSXF 08020 E	●	20	20	30	80	110	3	0,22	1
08025 E	●	25	25	30	90	120	4	0,40	1
08032 E	●	32	32	30	90	120	5	0,67	1
08040 E	●	40	32	30	90	120	6	0,73	2
08050 E	○	50	32	30	90	120	8	0,85	2
08063 E	○	63	32	35	90	125	10	1,10	2
08080 E	○	80	32	35	90	125	11	1,42	2

Inserts are not included.

## Inserts

Application	Coated Carbide										RE
	ACU2500	XCU2500	ACP100	ACP200	ACP300	XCK2000	ACK200	ACK300	ACM200	ACM300	
High Speed / Light Cutting	●	●	●	●	●	●	●	●	●	●	
General Purpose Cutting	●	●	●	●	●	●	●	●	●	●	
Rough Cutting	●	●	●	●	●	●	●	●	●	●	
Cat. No.											
LNEX 080404 PNER-L	●			●	○		○	●	●	●	
080408 PNER-L	●			○	○		○	○	○	○	
080412 PNER-L	○			○	○		○	○	○	○	
080416 PNER-L	○			○	○		○	○	○	○	
LNEX 080404 PNER-G	●	○	○	●	●	○	●	●	●	●	
080408 PNER-G	●	○	○	●	●	○	●	●	●	●	
080412 PNER-G	●	○	○	●	●	○	●	●	●	●	
080416 PNER-G	●	○	○	●	●	○	●	●	●	●	

Dimensions (mm)

## Recommended Cutting Conditions

→ H20

## Identification Details

<b>TSX</b>	<b>F/M</b>	<b>08</b>	<b>032</b>	<b>E</b>
Cutter Series	F: Fine Pitch M: Medium Pitch	Insert Size	Cutter Diameter	Endmill Type

## Spare Parts

Insert Screw	Insert Wrench	Applicable Cutters
 BFTX0306IP BFTX0308IP	 2,0 TRDR08IP	

● = Euro stock  
○ = Japan stock

Recommended Tightening Torque (N·m)

## Shank Type

Rake Angle	Radial	-31° - -15°	12 mm	90°
	Axial	-6°		



Fig. 1

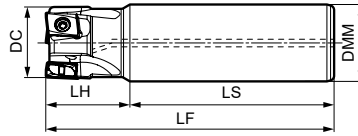
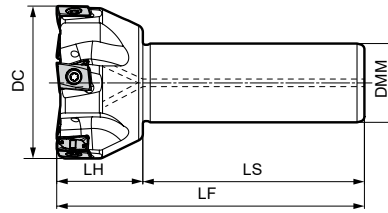

Fig. 2



## Body - TSX, Standard Pitch

Cat. No.	Stock	Dimensions (mm)					No. of Teeth	Weight (kg)	Figure
		DC	DMM	LH	LS	LF			
TSX 13025 E	●	25	25	35	85	120	2	0,38	1
13032 E	●	32	32	35	85	120	2	0,66	1
13040 E	●	40	32	30	90	120	3	0,71	2
13050 E	●	50	32	30	90	120	4	0,81	2
13063 E	○	63	32	35	90	125	5	1,08	2
13080 E	○	80	32	35	90	125	5	1,40	2

Inserts are not included.

## Body - TSXM, Medium Pitch

Cat. No.	Stock	Dimensions (mm)					No. of Teeth	Weight (kg)	Figure
		DC	DMM	LH	LS	LF			
TSXM 13032 E	●	32	32	35	85	120	3	0,35	1
13040 E	●	40	32	30	90	120	4	0,71	2
13050 E	●	50	32	30	90	120	5	0,80	2
13063 E	○	63	32	35	90	125	6	1,07	2
13080 E	○	80	32	35	90	125	7	1,41	2

Inserts are not included.

## Body - TSXF, Fine Pitch

Cat. No.	Stock	Dimensions (mm)					No. of Teeth	Weight (kg)	Figure
		DC	DMM	LH	LS	LF			
TSXF 13040 E	●	40	32	30	90	120	5	0,70	2
13050 E	●	50	32	30	90	120	6	0,80	2
13063 E	○	63	32	30	90	125	7	1,07	2
13080 E	○	80	32	35	90	125	8	1,42	2

Inserts are not included.

## Inserts

Dimensions (mm)

Application	Coated Carbide								RE	
	ACU2500	XCU2500	ACP100	ACP200	ACP300	XCK2000	ACK200	ACK300		ACM200
High Speed / Light Cutting	●	●	●	●	●	●	●	●	●	●
General Purpose Cutting	●	●	●	●	●	●	●	●	●	●
Rough Cutting	●	●	●	●	●	●	●	●	●	●
Cat. No.										
LNEX 130604 PNER-L	●			●	●	○	○	●	○	●
130608 PNER-L	●			●	●	○	○	●	○	●
130612 PNER-L	○			○	○			○	○	○
130616 PNER-L	○			○	○			○	○	○
130620 PNER-L	○			○	○			○	○	○
130624 PNER-L	○			○	○			○	○	○
130632 PNER-L	○			○	○			○	○	○
LNEX 130604 PNER-G	●	○	○	●	●	○	○	●	○	●
130608 PNER-G	●	○	○	●	●	○	○	●	○	●
130612 PNER-G	○			○	○			○	○	○
130616 PNER-G	○			○	○			○	○	○
130620 PNER-G	○			○	○			○	○	○
130624 PNER-G	○			○	○			○	○	○
130632 PNER-G	○			○	○			○	○	○
LNEX 130604 PNER-H	○			○	○	○	○			
130608 PNER-H	●	○		●	●	○	○	●		
130612 PNER-H	○			○	○			○		
130616 PNER-H	○			○	○			○		
130620 PNER-H	○			○	○			○		
130624 PNER-H	○			○	○			○		
130632 PNER-H	○			○	○			○		

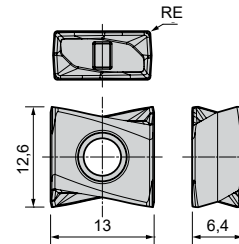

## Recommended Cutting Conditions

→ H20

## Spare Parts

## Identification Details

→ H22

Insert Screw	Insert Wrench
BFTX03510IP	TRDR15IP
3,0	

# "Sumi Dual Mill" Series TSXR 08000 E

Expansion

## Shank Type

Rake Angle	Radial	-33° - -18°	21-40 mm	90°
	Axial	-6° - -3°		

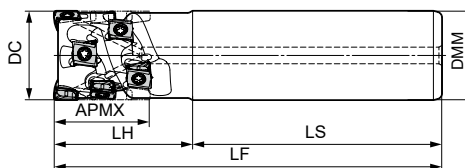

## Body - TSXR

Cat. No.	Stock	Dimensions (mm)						No. of Teeth	Steps	Effective Teeth
		DC	APMX	DMM	LH	LS	LF			
TSXR 08020E2120Z01	○	20	21	20	30	80	110	3	3	1
08025E2725Z02	○	25	27	25	35	90	125	8	4	2
08032E3432Z02	○	32	34	32	50	90	140	10	5	2
08040E4032Z03	○	40	40	32	60	90	150	18	6	3

Inserts are not included.

## Inserts

Dimensions (mm)

Application	Coated Carbide								RE	
	ACU2500	XCU2500	ACP100	ACP200	ACP300	XCK2000	ACK200	ACK300		ACM200
High Speed / Light Cutting	●	●	●	●	●	●	●	●	●	●
General Purpose Cutting	●	●	●	●	●	●	●	●	●	●
Rough Cutting	●	●	●	●	●	●	●	●	●	●
Cat. No.	ACU2500	XCU2500	ACP100	ACP200	ACP300	XCK2000	ACK200	ACK300	ACM200	ACM300
LNEX 080404 PNER-L	●	○	○	●	○	○	●	●	●	●
080408 PNER-L	●	○	○	●	○	○	●	●	●	●
080412 PNER-L	○	○	○	○	○	○	○	○	○	○
080416 PNER-L	○	○	○	○	○	○	○	○	○	○
LNEX 080404 PNER-G	●	○	○	●	○	○	●	●	●	●
080408 PNER-G	●	○	○	●	○	○	●	●	●	●
080412 PNER-G	●	○	○	●	○	○	●	●	●	●
080416 PNER-G	●	○	○	●	○	○	●	●	●	●

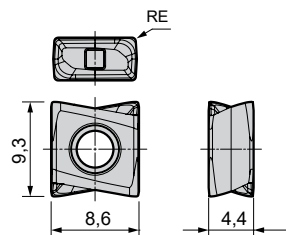

## Recommended Cutting Conditions

Min. - Optimum - Max.

ISO	Work-material	Hardness	Cutting Speed $v_c$ (m/min)	Feed Rate $f_t$ (mm/T)	Grade
P	Carbon Steel	180-280HB	110-200-280	0,10-0,20-0,30	ACU2500 ACP100 ACP200 ACP300 XCU2500
		> 280HB	70-135-200	0,10-0,20-0,30	
	Alloy Steel	180-280HB	90-155-220	0,10-0,15-0,25	XCU2500
M	Stainless Steel	220-280HB	90-135-180	0,10-0,15-0,25	ACU2500 ACM200 ACM300
		>280HB	70-115-160	0,10-0,15-0,25	
K	Cast Iron Ductile Cast Iron	250HB	125-175-225	0,10-0,20-0,30	ACU2500 ACK200 ACK300 XCU2500 XCK2000
S	Exotic Material	-	30-60-90	0,05-0,10-0,15	ACU2500 ACM200 ACM300

## Identification Details

**TSXR 08 025 E 27 25 Z02**

Cutter Series	Insert Size	Cutter Diameter	Shank Type	Max. Depth of Cut	Shank Diameter	Effective Teeth
TSXR	08	025	E	27	25	Z02

## Spare Parts

Insert Wrench	Insert Screw
TRDR08IP	BFTX0308IP 2,0

● = Euro stock  
○ = Japan stock

Recommended Tightening Torque (N·m)

Expansion

# "Sumi Dual Mill" Series TSXR 13000 E

## Shank Type



Rake Angle	Radial	-23° - -18°	41-60 mm	90°
	Axial	-6° - -3°		

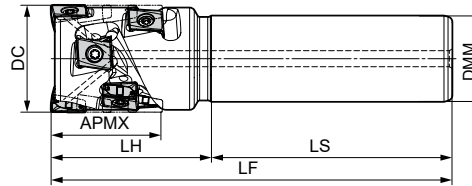

## Body - TSXR

Cat. No.	Stock	Dimensions (mm)						No. of Teeth	Steps	Effective Teeth
		DC	APMX	DMM	LH	LS	LF			
TSXR 13040E4132Z02	○	40	41	32	60	90	150	8	4	2
13050E6042Z03	○	50	60	42	80	90	170	18	6	3

Inserts are not included.

## Inserts

Dimensions (mm)

Application	Coated Carbide								RE	
	ACU2500	XCU2500	ACP100	ACP200	ACP300	XCK2000	ACK200	ACK300		ACM200
High Speed / Light Cutting	●	●	●	●	○	○	○	○	○	○
General Purpose Cutting	●	●	●	●	○	○	○	○	○	○
Rough Cutting	●	○	○	○	○	○	○	○	○	○
Cat. No.										
LNEX 130604 PNER-L	●	○	○	○	○	○	○	○	○	○
130608 PNER-L	●	○	○	○	○	○	○	○	○	○
130612 PNER-L	○	○	○	○	○	○	○	○	○	○
130616 PNER-L	○	○	○	○	○	○	○	○	○	○
130620 PNER-L	○	○	○	○	○	○	○	○	○	○
130624 PNER-L	○	○	○	○	○	○	○	○	○	○
130632 PNER-L	○	○	○	○	○	○	○	○	○	○
LNEX 130604 PNER-G	●	○	○	○	○	○	○	○	○	○
130608 PNER-G	●	○	○	○	○	○	○	○	○	○
130612 PNER-G	○	○	○	○	○	○	○	○	○	○
130616 PNER-G	●	○	○	○	○	○	○	○	○	○
130620 PNER-G	●	○	○	○	○	○	○	○	○	○
130624 PNER-G	●	○	○	○	○	○	○	○	○	○
130632 PNER-G	●	○	○	○	○	○	○	○	○	○
LNEX 130604 PNER-H	○	○	○	○	○	○	○	○	○	○
130608 PNER-H	●	○	○	○	○	○	○	○	○	○
130612 PNER-H	○	○	○	○	○	○	○	○	○	○
130616 PNER-H	●	○	○	○	○	○	○	○	○	○
130620 PNER-H	○	○	○	○	○	○	○	○	○	○
130624 PNER-H	●	○	○	○	○	○	○	○	○	○
130632 PNER-H	●	○	○	○	○	○	○	○	○	○

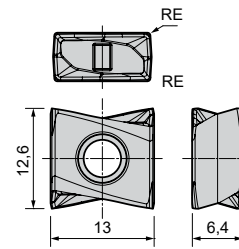

## Recommended Cutting Conditions

→ H24

## Identification Details

**TSXR 13 050 E 60 42 Z03**

Cutter Series	Insert Size	Cutter Diameter	Shank Type	Max. Depth of Cut	Shank Diameter	Effective Teeth
TSXR	13	050	E	60	42	Z03

## Spare Parts

Insert Wrench	Insert Screw
TRDR15IP	BFTX03510IP 3,0

Indexable Endmills

# "Wave Mill" Series

## WEZ Type

Expansion



### General Features

- Supports various machining operations
- Excellent machining quality
- Excellent sharpness with low resistance
- General-purpose grade applicable to any work material

### Product Range

Type	Cat. No.	Diameter Range (mm) / No of Teeth																		
		Ø14	Ø16	Ø18	Ø20	Ø22	Ø25	Ø26	Ø28	Ø30	Ø32	Ø35	Ø40	Ø50	Ø63	Ø80	Ø100	Ø125	Ø160	
Shell	WEZ 11000RS	→ G48																		
	WEZ 11000R (Inch)																			
	WEZ 17000RS	→ G50																		
	WEZ 17000R (Inch)																			
Shank	WEZ 11000E	1	2*	2	2*, 3*	3	2, 3*, 4*		4	4	2, 3, 4, 5*	5	2, 4, 6	5, 7	8	10				
	WEZ 11000ES	1	2*		3*		4*													
	WEZ 11000EL	1	2*	2	2*	2	2*, 3		2	2	2*, 3	2, 3	2	3						
	WEZ 17000E						2*		2	3	2, 3*	3	3, 4	3*, 5*	4*, 6*	7				
	WEZ 17000ES						2				3									
	WEZ 17000EL						2		2	2	2*, 3	2	2, 3, 4	3*, 5*	4*, 6*					
Modular	WEZ 11000M		2	2	2, 3	3	2, 3, 4	4, 5	4, 5	2, 4, 5	2, 3, 4, 5	2, 5	2, 4, 5, 6							
	WEZ 17000M						2, 3		2	2, 3	2, 3, 4	2, 3	2, 3, 4							

\* Different shank diameters in stock

### Suitable Applications

- Supports Ramping, Helical Milling, Plunge Cutting

### Optimised Body Design

Wide guide face for stable insert clamping.



WEZ11 type

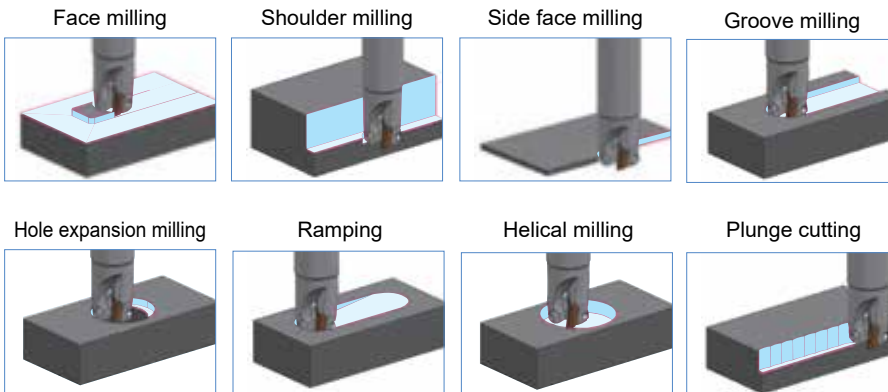

### Chipbreaker Lineup

Work Material	P M K S H					N
	L Type	G Type	H Type	F Type	P Type	S Type
Chipbreaker						
AO_T11 Cutting edge geometry		28°	20°	28°	28°	28°
AO_T17 Cutting edge geometry	28°	20°	10°	28°	28°	28°
Applications	Light cut, low rigidity machining	Main breaker for general purpose to interrupted machining	Heavy cut, heavy interrupted machining, hardened steel	Light cut, finishing, low-burr design	Light cut, high-precision machining, high surface wall quality	For non-ferrous metals

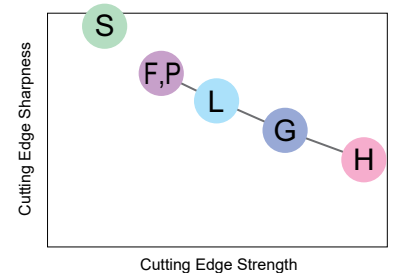

## Product Range Inserts

Main Grade: ACU2500; S-Type: H20, DL2000

Cat. No.	Nose Radius (mm)													
	R0,2	R0,4	R0,5	R0,8	R1,0	R1,2	R1,6	R2,0	R2,4	R3,0	R3,2	R4,0	R5,0	R6,4
AOET 11T3 PEER-G	●	●	●	●	●	●	●	●	●	●	●			
AOET 11T3 PEER-H	●	●	●	●	●	●	●	●	●	●	●			
AOET 11T3 PEER-F	●	●	●	●	●	●	●	●	●	●	●			
AOET 11T3 PEER-P16	●	●	●	●	●	●	●	●	●	●	●			
AOET 11T3 PEER-P20	●	●	●	●	●	●	●	●	●	●	●			
AOET 11T3 PEER-P25	●	●	●	●	●	●	●	●	●	●	●			
AOET 11T3 PEFR-S	●	●	●	●	●	●	●	●	●	●	●			
AOMET 1705 PEER-L	●	●	●	●	●	●	●	●	●	●	●			
AOMET 1705 PEER-G	●	●	●	●	●	●	●	●	●	●	●	●	●	●
AOMET 1705 PEER-H	●	●	●	●	●	●	●	●	●	●	●	●	●	●
AOET 1705 PEER-F	●	●	●	●	●	●	●	●	●	●	●	●	●	●
AOET 1705 PEER-P25	●	●	●	●	●	●	●	●	●	●	●	●	●	●
AOET 1705 PEER-P32	●	●	●	●	●	●	●	●	●	●	●	●	●	●
AOET 1705 PEFR-S	●	●	●	●	●	●	●	●	●	●	●	●	●	●

## Lineup of Chipbreakers for Ground Inserts

### F Type

Cutting edge specialized for sharpness and machining accuracy



Sharpness from ground finish enables burr control.

Excellent squareness with all diameters.

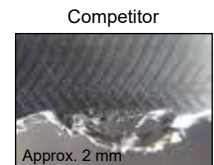
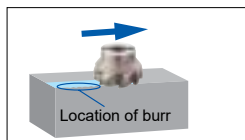

Machine: Vertical Machining Centre BT50,  
Work Material: X5CrNiS18 9  
Tool: WEZ 11050 RS07 (Ø 50, 7 teeth)  
Insert: AOET11T308PEER-F (ACU2500)  
Cutting Conditions:  $v_c = 120$  m/min,  $f_z = 0,12$  mm/t,  $a_p = 1$  mm,  $a_e = 30$  mm, dry

### P Type

Chipbreaker for wall surface squareness equivalent to solid endmills



Premium item with cutting edge shape optimised for each cutter diameter while maintaining the F type chipbreaker's sharpness.

Enables wall surface squareness equal to solid endmills through a blade shape optimised for each tool diameter.

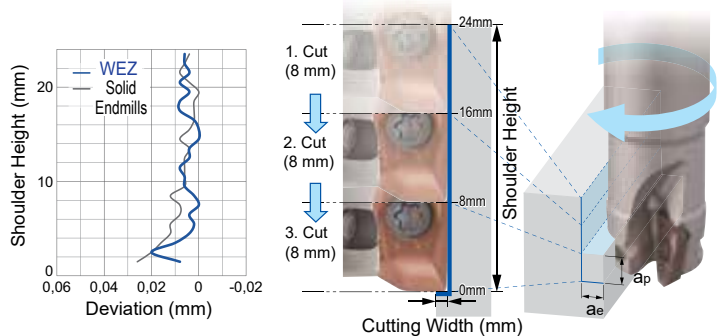

P Type Chipbreaker Selection

Cat. No.	Cutter Diameter (mm)										
	Ø14	Ø16	Ø18	Ø20	Ø22	Ø25	Ø28	Ø30	Ø32	Ø35	⇒ Ø40
AOET11T3 PEER-P	-P16	-P20	-	-P25	-	-	-	-	-	-	-
AOET1705 PEER-P	-	-	-	-P25	-P32	-	-	-	-	-	-

Machine: Vertical Machining Centre BT50,  
Work Material: C50  
Tool: WEZ 11020 E03 (Ø 20, 3 teeth)  
Insert: AOET11T308PEER-P20 (ACU2500)  
Cutting Conditions:  $v_c = 150$  m/min,  $f_z = 0,1$  mm/t,  $a_p = 8$  mm x 3 passes,  $a_e = 1$  mm, dry

### S Type

Sharp edge chipbreaker for non-ferrous metals, with excellent adhesion resistance



Suppresses adhesion with rake face lapping.

DLC coat inserts available for further improved adhesion resistance.



Machine: Vertical Machining Centre BT50,  
Work Material: AISi12Cu  
Tool: WEZ 11020 E03 (Ø 20, 3 teeth)  
Insert: AOET11T308PEER-S (H20)  
Cutting Conditions:  $v_c = 350$  m/min,  $f_z = 0,1$  mm/t,  $a_p = 3$  mm,  $a_e = 10$  mm, dry



# "Wave Mill" Series

## WEZ Type



### Recommended Cutting Conditions

#### WEZ11 Type

Cutter: WEZ 11020 E03  
 Insert: AO\_T11T3 type  
 Cutting Data:  $a_p = 3 \text{ mm}$ ,  $a_e = 10 \text{ mm}$ , dry

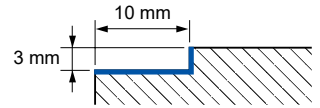

Min. - Optimum - Max.

ISO	Material	HB	Chipbreaker	Grade										
				ACU2500	XCU2500	ACP2000	ACP3000	T2500A	XCK2000	ACK2000	ACK3000	ACM200	ACM300	DL2000
				Feed Rate (mm/tooth)										
				0,08-0,15-0,20	0,08-0,15-0,20	0,08-0,15-0,20	0,08-0,15-0,20	0,08-0,15-0,18	0,08-0,15-0,20	0,08-0,15-0,20	0,08-0,15-0,20	0,08-0,15-0,20	0,08-0,15-0,20	0,05-0,10-0,15
				Cutting Speed $v_c$ (m/min)										
P	Unalloyed steel, <0,15%C, annealed	125	G	270-320-370	300-350-400	300-350-400	250-300-350	230-280-330						
	Unalloyed steel, <0,45%C, annealed	190	G	170-220-270	200-250-300	200-250-300	150-200-250	130-180-230						
	Unalloyed steel, <0,45%C, tempered	250	G	140-180-220	160-200-245	160-200-245	120-160-200	105-145-185						
	Unalloyed steel, <0,75%C, annealed	270	G	110-145-175	130-165-195	130-165-195	100-130-165	85-115-150						
	Unalloyed steel, <0,75%C, tempered	300	G	70-90-110	80-100-120	80-100-120	60-80-100	50-70-90						
	Low alloyed steel, annealed	180	G	160-205-255	190-235-280	190-235-280	140-190-235	120-170-215						
	Low alloyed steel, tempered	275	G	90-120-150	110-135-165	110-135-165	80-110-140	70-100-125						
	Low alloyed steel, hardened	300	G	85-110-130	100-125-150	100-125-150	75-100-125	65-90-115						
	High alloyed and tool steel, annealed	200	G	140-180-220	160-200-245	160-200-245	120-160-205							
	High alloyed and tool steel, hardened	325	G	55-70-85	60-80-100	60-80-100	50-65-80							
M	Stainless steel, ferritic/martensitic, annealed	200	G	110-140-170	160-190-210					140-170-190	90-110-140			
	Stainless steel, martensitic, tempered	240	G	100-125-150	145-170-190					125-150-170	80-100-125			
	Stainless steel, austenitic, plunged	180	G	120-150-180	170-200-220					150-180-200	100-120-150			
K	Grey cast iron		G	150-200-250	250-300-350			250-300-350	250-300-350	170-220-270				
	Nodular cast iron		G	90-120-150	150-180-210			150-180-210	150-180-210	100-130-160				
S	High tempered resist. alloys, Fe based, annealed		G	30-40-55							35-45-60	25-35-50		
	High tempered resist. alloys, Fe based, hardened		G	60-80-100							70-90-110	50-70-90		
N	Aluminium alloy, Si < 12,6%		S										500-750-1000	
	Aluminium alloy, Si > 12,6%		S										170-200-250	
	Copper alloy		S										300-330-350	

The above recommended cutting conditions are meant as a guide. Actual conditions will depend on the individual machine, work shape and clamping. They will need to be adjusted according to machine rigidity, work clamp rigidity, cutting depth and other factors.

For groove milling, reduce the feed rate approximately 70 % of the corresponding value shown above.

#### WEZ17 Type

Cutter: WEZ 17032 E03  
 Insert: AO\_T1705 type  
 Cutting Data:  $a_p = 5 \text{ mm}$ ,  $a_e = 16 \text{ mm}$ , dry

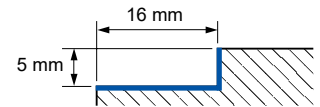

Min. - Optimum - Max.

ISO	Material	HB	Chipbreaker	Grade										
				ACU2500	XCU2500	ACP2000	ACP3000	T2500A	XCK2000	ACK2000	ACK3000	ACM200	ACM300	DL2000
				Feed Rate (mm/tooth)										
				0,10-0,20-0,28	0,10-0,20-0,28	0,10-0,20-0,28	0,10-0,20-0,28	0,10-0,15-0,22	0,10-0,20-0,28	0,10-0,20-0,28	0,10-0,20-0,28	0,10-0,20-0,28	0,10-0,20-0,28	0,05-0,10-0,15
				Cutting Speed $v_c$ (m/min)										
P	Unalloyed steel, <0,15%C, annealed	125	G	285-335-390	315-360-420	315-360-420	265-315-370	240-295-345						
	Unalloyed steel, <0,45%C, annealed	190	G	180-230-285	210-265-315	210-265-315	160-210-265	135-190-240						
	Unalloyed steel, <0,45%C, tempered	250	G	145-190-230	170-210-255	170-210-255	130-170-215	110-155-195						
	Unalloyed steel, <0,75%C, annealed	270	G	115-150-185	135-170-205	135-170-205	100-135-170	90-125-155						
	Unalloyed steel, <0,75%C, tempered	300	G	70-90-115	85-105-125	85-105-125	65-85-105	55-75-95						
	Low alloyed steel, annealed	180	G	170-220-265	200-245-295	200-245-295	150-200-250	130-180-225						
	Low alloyed steel, tempered	275	G	100-130-155	115-145-175	115-145-175	85-115-145	75-105-135						
	Low alloyed steel, hardened	300	G	90-115-140	105-130-155	105-130-155	75-105-130	65-90-120						
	High alloyed and tool steel, annealed	200	G	145-185-230	170-215-255	170-215-255	130-170-215							
	High alloyed and tool steel, hardened	325	G	55-75-90	65-85-100	65-85-100	50-65-85							
M	Stainless steel, ferritic/martensitic, annealed	200	G	115-145-175	165-195-215					145-175-195	100-115-145			
	Stainless steel, martensitic, tempered	240	G	105-130-155	150-175-195					130-155-175	85-105-130			
	Stainless steel, austenitic, plunged	180	G	125-155-190	180-210-230					160-190-210	105-125-160			
K	Grey cast iron		G	160-210-265	265-315-370			265-315-370	265-315-370	180-230-285				
	Nodular cast iron		G	95-125-160	160-190-220			160-190-220	160-190-220	105-140-170				
S	High tempered resist. alloys, Fe based, annealed		G	30-40-60							35-45-60	25-35-50		
	High tempered resist. alloys, Fe based, hardened		G	60-85-105							75-95-115	50-75-95		
N	Aluminium alloy, Si < 12,6%		S										500-750-1000	
	Aluminium alloy, Si > 12,6%		S										170-200-250	
	Copper alloy		S										300-330-350	

The above recommended cutting conditions are meant as a guide. Actual conditions will depend on the individual machine, work shape and clamping. They will need to be adjusted according to machine rigidity, work clamp rigidity, cutting depth and other factors.

For groove milling, reduce the feed rate approximately 70 % of the corresponding value shown above.

## ■ Ramping / Helical Milling Upper Limits

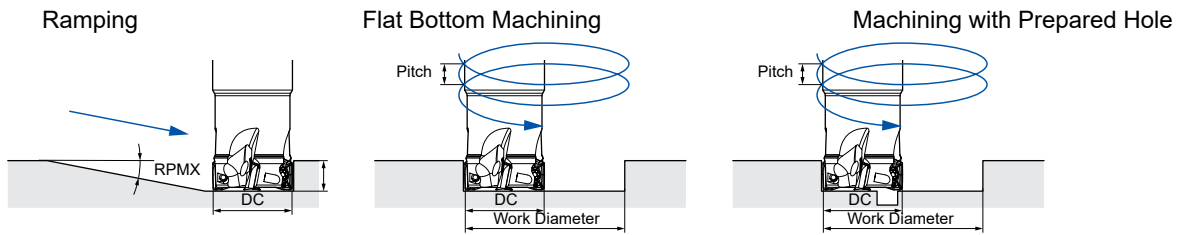

### ● WEZ11 Type

DC Ø (mm)	Max.Ramping Angle	Flat Bottom Machining				Machining with Prepared Hole	
	RPMX (°)	Max. Machining Diam. (mm)	Max. Pitch (mm/rev)	Min. Machining Diam. (mm)	Max. Pitch (mm/rev)	Min. Machining Diam. (mm)	Max. Pitch (mm/rev)
14	13,2	25,3	8,4	23,1	5,9	19,0	1,9
16	10,5	29,3	7,6	27,0	5,6	21,7	1,5
18	8,1	33,3	6,7	30,9	5,0	25,2	1,4
20	6,5	37,3	6,0	34,9	4,6	29,1	1,3
22	5,3	41,3	5,4	38,8	4,3	32,9	1,3
25	4,1	47,3	4,8	44,8	3,9	38,9	1,3
28	3,4	53,3	4,4	50,7	3,6	44,9	1,3
30	3,0	57,3	4,2	54,7	3,5	48,8	1,3
32	2,7	61,3	4,0	58,7	3,3	52,8	1,2
35	2,3	67,3	3,8	64,6	3,1	58,8	1,2
40	1,8	77,3	3,4	74,6	2,9	68,8	1,2
50	1,2	97,3	3,0	94,6	2,6	88,8	1,1
63	0,8	123,3	2,8	120,5	2,5	114,7	1,1

### ● WEZ17 Type

DC Ø (mm)	Max.Ramping Angle	Flat Bottom Machining				Machining with Prepared Hole	
	RPMX (°)	Max. Machining Diam. (mm)	Max. Pitch (mm/rev)	Min. Machining Diam. (mm)	Max. Pitch (mm/rev)	Min. Machining Diam. (mm)	Max. Pitch (mm/rev)
25	10,8	47,3	13,0	41,0	8,3	33,1	1,8
28	8,1	53,3	11,1	46,9	7,5	39,0	1,8
30	7,0	57,3	10,2	50,9	7,0	43,0	1,8
32	6,1	61,3	9,5	54,9	6,7	47,0	1,7
35	5,1	67,3	8,7	60,8	6,2	53,0	1,7
40	4,0	77,3	7,7	70,8	5,7	63,0	1,7
50	2,5	97,3	6,5	90,7	5,0	83,0	1,6
63	1,8	123,3	5,6	116,7	4,5	109,0	1,6

\* The table above shows values with nose radius 0,8 mm

## ■ Plunge Cutting - Upper Limit for Radial Width $a_e$

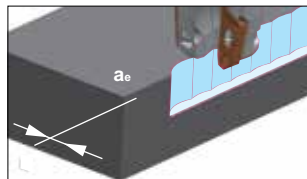

Type	Max. $a_e$ (mm)
WEZ11	3
WEZ17	5

## ■ Precautions for Mounting

- (1) Clean the mounting seat and contact parts.
- (2) Apply screw lubrication to the screw thread as well as the screw head face to prevent seizure.
- (3) While pressing the insert solidly against the seat surface, tighten at the screws with the included wrench.
- (4) After tightening, check that there are no gaps between the surfaces.



# "Wave Mill" Series

## WEZ 11000 E

Rake Angle	Radial	-7° -- -18°	10 mm	90°
	Axial	6° -- 15°		



Fig. 1

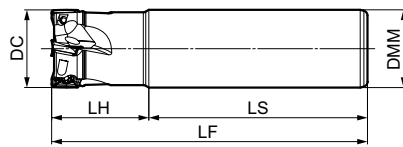
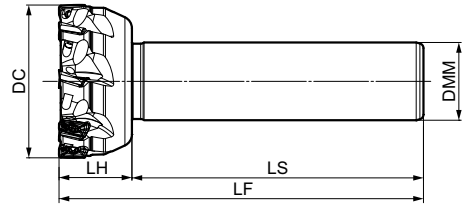

Fig. 2



### Body - WEZ (Shank Type)

Dimensions (mm)

Cat. No.	Stock	DC	DMM	LH	LS	LF	No. of Teeth	Weight (kg)	Fig.
WEZ 11014E01	●	14	16	25	55	80	1	0,10	1
11016E02	●	16	16	25	75	100	2	0,13	1
11016E02-12	●	16	12	25	75	100	2	0,07	2
11018E02	●	18	16	25	75	100	2	0,13	2
11020E02	●	20	20	30	80	110	2	0,23	1
11020E02-16	●	20	16	30	80	110	2	0,15	2
11020E03	●	20	20	30	80	110	3	0,22	1
11020E03-16	●	20	16	30	80	110	3	0,14	2
11022E03	●	22	20	30	80	110	3	0,23	1
11025E02	●	25	25	35	85	120	2	0,40	1
11025E03	●	25	25	35	85	120	3	0,40	1
11025E03-20	●	25	20	35	85	120	3	0,26	2
11025E04	●	25	25	35	85	120	4	0,39	2
11025E04-20	●	25	20	35	85	120	4	0,26	2
11028E04	●	28	25	35	85	120	4	0,41	1
11030E04	●	30	25	40	90	130	4	0,46	1
11032E02	●	32	32	40	90	130	2	0,74	1
11032E03	●	32	32	40	90	130	3	0,73	1
11032E04	●	32	32	40	90	130	4	0,73	2
11032E05	●	32	32	40	90	130	5	0,72	2
11032E05-25	●	32	25	40	90	130	5	0,46	2
11035E05	●	35	32	40	90	130	5	0,75	2
11040E02	●	40	32	30	120	150	2	0,96	2
11040E04	●	40	32	30	120	150	4	0,94	2
11040E06	●	40	32	30	120	150	6	0,93	2
11050E05	●	50	32	30	120	150	5	1,04	2
11050E07	●	50	32	30	120	150	7	1,04	2
11063E08	●	63	32	30	120	150	8	1,24	2
11080E10	●	80	32	30	120	150	10	1,52	2

Inserts are sold separately.

### Spare Parts

Applicable Cutters	Insert Screw		Wrench
WEZ 11014E01 11016E02(-12) 11018E02	BFTX0305IP	2,0	TRDR08IP
11020E02(-16) 11020E03(-16) 11022E03 11025E02 11025E03(-20) 11025E04(-20) 11028E04 11030E04 11032E02 11032E03 11032E04 11032E05(-25) 11035E05 11040E02 11040E04 11040E06 11050E05 11050E07 11063E08 11080E10			
	BFTX0306IP	1,5	

### Identification Details

<b>WEZ</b>	<b>11</b>	<b>025</b>	<b>E</b>	<b>02</b>	<b>-</b>	<b>22</b>
Cutter Series	Insert Size	Cutter Diameter	Round Shank	Number of Teeth		Shank Diameter

\*When mounting inserts with nose radius of  $\geq 2,4$  mm, modification of the body is required.



Modify this edge.

Reworking guidelines  
 Corner radius = 2,4 mm: C = 1 mm (AOMT11T324PEER)  
 Corner radius = 3,0 mm: C = 1 mm (AOMT11T330PEER)  
 Corner radius = 3,2 mm: C = 1 mm (AOMT11T332PEER)  
 Standard: R = 1 mm

C: Chamfer  
 R: Radius

## Inserts

Precautions for Mounting → H29

Application	Coated Carbide								Carbide	DLC	Cermets	RE	Fig.
	K	P	P	K	K	M	M	S					
High Speed / Light Cut													
General Purpose													
Roughing													
Cat. No.	ACU2500	XCU2500	ACP2000	ACP3000	XCK2000	ACK2000	ACK3000	ACM200	ACM300	H20	DL2000	T2500A	
AOMT 11T302PEER-G	●	○	□	●	○	□	●	●	●	-	-	●	0,2 1
11T304PEER-G	●	○	□	●	○	□	●	●	●	-	-	●	0,4 1
11T305PEER-G	●	○	□	●	○	□	●	●	●	-	-	●	0,5 1
11T308PEER-G	●	○	□	●	○	□	●	●	●	-	-	●	0,8 1
11T310PEER-G	●	○	□	●	○	□	●	●	●	-	-	□	1,0 1
11T312PEER-G	●	○	□	●	○	□	●	●	●	-	-	□	1,2 1
11T316PEER-G	●	○	□	●	○	□	●	●	●	-	-	□	1,6 1
11T320PEER-G	●	○	□	●	○	□	●	●	●	-	-	□	2,0 1
11T324PEER-G	●	○	□	●	○	□	●	●	●	-	-	□	2,4 1
11T330PEER-G	●	○	□	●	○	□	●	●	●	-	-	□	3,0 2
11T332PEER-G	●	○	□	●	○	□	●	●	●	-	-	□	3,2 2
AOMT 11T304PEER-H	●	○	□	●	○	□	●	●	●	-	-	-	0,4 1
11T308PEER-H	●	○	□	●	○	□	●	●	●	-	-	-	0,8 1
11T312PEER-H	●	○	□	●	○	□	●	●	●	-	-	-	1,2 1
11T316PEER-H	●	○	□	●	○	□	●	●	●	-	-	-	1,6 1
AOET 11T302PEER-F	●	-	-	-	-	-	-	-	-	-	-	-	0,2 1
11T304PEER-F	●	-	-	-	-	-	-	-	-	-	-	-	0,4 1
11T305PEER-F	●	-	-	-	-	-	-	-	-	-	-	-	0,5 1
11T308PEER-F	●	-	-	-	-	-	-	-	-	-	-	-	0,8 1
11T310PEER-F	●	-	-	-	-	-	-	-	-	-	-	-	1,0 1
11T312PEER-F	●	-	-	-	-	-	-	-	-	-	-	-	1,2 1
11T316PEER-F	●	-	-	-	-	-	-	-	-	-	-	-	1,6 1
11T320PEER-F	●	-	-	-	-	-	-	-	-	-	-	-	2,0 1
11T324PEER-F	●	-	-	-	-	-	-	-	-	-	-	-	2,4 1
11T330PEER-F	●	-	-	-	-	-	-	-	-	-	-	-	3,0 2
11T332PEER-F	●	-	-	-	-	-	-	-	-	-	-	-	3,2 2
AOET 11T302PEER-P16	●	-	-	-	-	-	-	-	-	-	-	-	0,2 1
11T304PEER-P16	●	-	-	-	-	-	-	-	-	-	-	-	0,4 1
11T305PEER-P16	●	-	-	-	-	-	-	-	-	-	-	-	0,5 1
11T308PEER-P16	●	-	-	-	-	-	-	-	-	-	-	-	0,8 1
11T310PEER-P16	●	-	-	-	-	-	-	-	-	-	-	-	1,0 1
11T312PEER-P16	●	-	-	-	-	-	-	-	-	-	-	-	1,2 1
11T302PEER-P20	●	-	-	-	-	-	-	-	-	-	-	-	0,2 1
11T304PEER-P20	●	-	-	-	-	-	-	-	-	-	-	-	0,4 1
11T305PEER-P20	●	-	-	-	-	-	-	-	-	-	-	-	0,5 1
11T308PEER-P20	●	-	-	-	-	-	-	-	-	-	-	-	0,8 1
11T310PEER-P20	●	-	-	-	-	-	-	-	-	-	-	-	1,0 1
11T312PEER-P20	●	-	-	-	-	-	-	-	-	-	-	-	1,2 1
11T302PEER-P25	●	-	-	-	-	-	-	-	-	-	-	-	0,2 1
11T304PEER-P25	●	-	-	-	-	-	-	-	-	-	-	-	0,4 1
11T305PEER-P25	●	-	-	-	-	-	-	-	-	-	-	-	0,5 1
11T308PEER-P25	●	-	-	-	-	-	-	-	-	-	-	-	0,8 1
11T310PEER-P25	●	-	-	-	-	-	-	-	-	-	-	-	1,0 1
11T312PEER-P25	●	-	-	-	-	-	-	-	-	-	-	-	1,2 1
AOET 11T302PEFR-S	-	-	-	-	-	-	-	-	●	●	-	-	0,2 1
11T304PEFR-S	-	-	-	-	-	-	-	-	●	●	-	-	0,4 1
11T305PEFR-S	-	-	-	-	-	-	-	-	●	●	-	-	0,5 1
11T308PEFR-S	-	-	-	-	-	-	-	-	●	●	-	-	0,8 1
11T310PEFR-S	-	-	-	-	-	-	-	-	●	●	-	-	1,0 1
11T312PEFR-S	-	-	-	-	-	-	-	-	●	●	-	-	1,2 1
11T316PEFR-S	-	-	-	-	-	-	-	-	●	●	-	-	1,6 1
11T320PEFR-S	-	-	-	-	-	-	-	-	●	●	-	-	2,0 1
11T324PEFR-S	-	-	-	-	-	-	-	-	●	●	-	-	2,4 1
11T330PEFR-S	-	-	-	-	-	-	-	-	●	●	-	-	3,0 2
11T332PEFR-S	-	-	-	-	-	-	-	-	●	●	-	-	3,2 2

Dimensions (mm)

Fig. 1

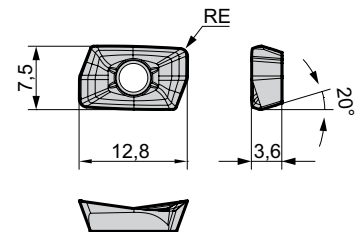
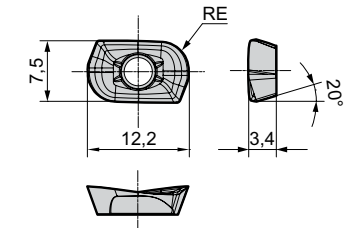

Fig. 2



L: Low cutting force  
G: General purpose  
H: Strong edge  
F: Finishing  
P: High-precision machining  
S: Non ferrous metals

\*P16 is applicable to cutter diameters Ø 14 mm and Ø 16 mm.

\*P20 is applicable to cutter diameters Ø 18 mm, Ø 20 mm.

\*P25 is applicable to cutter diameters Ø 25 mm, Ø 28 mm.

## Recommended Cutting Conditions

→ H28

# "Wave Mill" Series WEZ 11000 ES

Series for Multi-Tasking Machines

Rake Angle	Radial	-14° - -18°	10 mm	90°
	Axial	6° - 10°		



Fig. 1

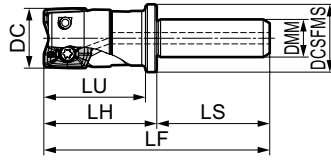
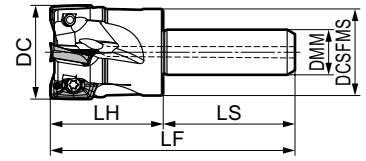

Fig. 2



## ■ Body - WEZ (Short Shank Type)

Dimensions (mm)

Cat. No.	Stock	DC	DCSFMS	DMM	LH	LU	LS	LF	No. of Teeth	Weight (kg)	Fig.
WEZ 11014ES01-12	○	14	18	12	30	27	35	65	1	0,05	1
11016ES02-10	○	16	18	10	25	22	30	55	2	0,04	1
11016ES02-12	○	16	18	12	30	27	35	65	2	0,05	1
11020ES03-10	○	20	18	10	25	-	30	55	3	0,04	2
11020ES03-12	○	20	18	12	30	-	35	65	3	0,06	2
11020ES03-16	○	20	23	16	30	27	40	70	3	0,10	1
11025ES04-12	○	25	23	12	30	-	35	65	4	0,09	2
11025ES04-16	○	25	23	16	30	-	40	70	4	0,12	2

Inserts are sold separately.

## ■ Spare Parts

Applicable Cutters	Insert Screw	Wrench	
	WEZ 11014ES01-12 11016ES02-10 11016ES02-12 11020ES03-10 11020ES03-12 11020ES03-16 11025ES04-12 11025ES04-16	BFTX0305IP BFTX0306IP	1,5

## ■ Identification Details

**WEZ 11 020 E S 03 - 12**

Cutter Series    Insert Size    Cutter Diameter    Round Shank    Short Shank    Number of Teeth    Shank Diameter

\*When mounting inserts with nose radius of  $\geq 2,4$  mm, modification of the body is required.



Modify this edge.

Reworking guidelines  
 Corner radius = 2,4 mm: C = 1 mm (AOMT11T324PEER)  
 Corner radius = 3,0 mm: C = 1 mm (AOMT11T330PEER)  
 Corner radius = 3,2 mm: C = 1 mm (AOMT11T332PEER)  
 Standard: R = 1 mm

C: Chamfer  
 R: Radius

## ■ Recommended Cutting Conditions → H28

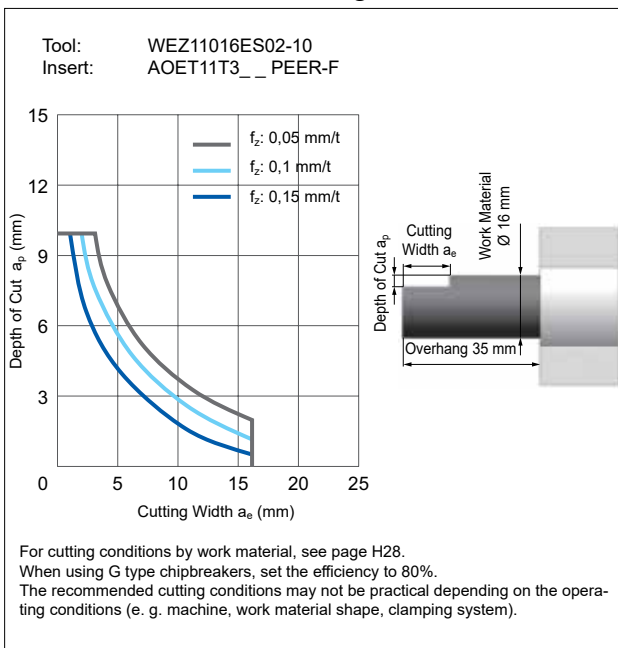

## Inserts

## Precautions for Mounting → H29

Application	Coated Carbide								Carbide	DLC	Cermets	RE	Fig.
	K	P	P	K	K	M	M	N					
High Speed / Light Cut													
General Purpose													
Roughing													
Cat. No.	ACU2500	XCU2500	ACP2000	ACP3000	XCK2000	ACK2000	ACK3000	ACM200	ACM300	H20	DL2000	T2500A	
AOMT 11T302PEER-G	●	○	□	●	○	□	●	●	●	-	-	●	0,2 1
11T304PEER-G	●	○	□	●	○	□	●	●	●	-	-	●	0,4 1
11T305PEER-G	●	○	□	●	○	□	●	●	●	-	-	●	0,5 1
11T308PEER-G	●	○	□	●	○	□	●	●	●	-	-	●	0,8 1
11T310PEER-G	●	○	□	●	○	□	●	●	●	-	-	□	1,0 1
11T312PEER-G	●	○	□	●	○	□	●	●	●	-	-	□	1,2 1
11T316PEER-G	●	○	□	●	○	□	●	●	●	-	-		1,6 1
11T320PEER-G	●	○	□	●	○	□	●	●	●	-	-		2,0 1
11T324PEER-G	●	○	□	●	○	□	●	●	●	-	-		2,4 1
11T330PEER-G	●	○	□	●	○	□	●	●	●	-	-		3,0 2
11T332PEER-G	●	○	□	●	○	□	●	●	●	-	-		3,2 2
AOMT 11T304PEER-H	●	○	□	●	○	□	●	●	●	-	-		0,4 1
11T308PEER-H	●	○	□	●	○	□	●	●	●	-	-		0,8 1
11T312PEER-H	●	○	□	●	○	□	●	●	●	-	-		1,2 1
11T316PEER-H	●	○	□	●	○	□	●	●	●	-	-		1,6 1
AOET 11T302PEER-F	●	-	-	-	-	-	-	-	-	-	-		0,2 1
11T304PEER-F	●	-	-	-	-	-	-	-	-	-	-		0,4 1
11T305PEER-F	●	-	-	-	-	-	-	-	-	-	-		0,5 1
11T308PEER-F	●	-	-	-	-	-	-	-	-	-	-		0,8 1
11T310PEER-F	●	-	-	-	-	-	-	-	-	-	-		1,0 1
11T312PEER-F	●	-	-	-	-	-	-	-	-	-	-		1,2 1
11T316PEER-F	●	-	-	-	-	-	-	-	-	-	-		1,6 1
11T320PEER-F	●	-	-	-	-	-	-	-	-	-	-		2,0 1
11T324PEER-F	●	-	-	-	-	-	-	-	-	-	-		2,4 1
11T330PEER-F	●	-	-	-	-	-	-	-	-	-	-		3,0 2
11T332PEER-F	●	-	-	-	-	-	-	-	-	-	-		3,2 2
AOET 11T302PEER-P16	●	-	-	-	-	-	-	-	-	-	-		0,2 1
11T304PEER-P16	●	-	-	-	-	-	-	-	-	-	-		0,4 1
11T305PEER-P16	●	-	-	-	-	-	-	-	-	-	-		0,5 1
11T308PEER-P16	●	-	-	-	-	-	-	-	-	-	-		0,8 1
11T310PEER-P16	●	-	-	-	-	-	-	-	-	-	-		1,0 1
11T312PEER-P16	●	-	-	-	-	-	-	-	-	-	-		1,2 1
11T302PEER-P20	●	-	-	-	-	-	-	-	-	-	-		0,2 1
11T304PEER-P20	●	-	-	-	-	-	-	-	-	-	-		0,4 1
11T305PEER-P20	●	-	-	-	-	-	-	-	-	-	-		0,5 1
11T308PEER-P20	●	-	-	-	-	-	-	-	-	-	-		0,8 1
11T310PEER-P20	●	-	-	-	-	-	-	-	-	-	-		1,0 1
11T312PEER-P20	●	-	-	-	-	-	-	-	-	-	-		1,2 1
11T302PEER-P25	●	-	-	-	-	-	-	-	-	-	-		0,2 1
11T304PEER-P25	●	-	-	-	-	-	-	-	-	-	-		0,4 1
11T305PEER-P25	●	-	-	-	-	-	-	-	-	-	-		0,5 1
11T308PEER-P25	●	-	-	-	-	-	-	-	-	-	-		0,8 1
11T310PEER-P25	●	-	-	-	-	-	-	-	-	-	-		1,0 1
11T312PEER-P25	●	-	-	-	-	-	-	-	-	-	-		1,2 1
AOET 11T302PEFR-S	-	-	-	-	-	-	-	-	●	●	-		0,2 1
11T304PEFR-S	-	-	-	-	-	-	-	-	●	●	-		0,4 1
11T305PEFR-S	-	-	-	-	-	-	-	-	●	●	-		0,5 1
11T308PEFR-S	-	-	-	-	-	-	-	-	●	●	-		0,8 1
11T310PEFR-S	-	-	-	-	-	-	-	-	●	●	-		1,0 1
11T312PEFR-S	-	-	-	-	-	-	-	-	●	●	-		1,2 1
11T316PEFR-S	-	-	-	-	-	-	-	-	●	●	-		1,6 1
11T320PEFR-S	-	-	-	-	-	-	-	-	●	●	-		2,0 1
11T324PEFR-S	-	-	-	-	-	-	-	-	●	●	-		2,4 1
11T330PEFR-S	-	-	-	-	-	-	-	-	●	●	-		3,0 2
11T332PEFR-S	-	-	-	-	-	-	-	-	●	●	-		3,2 2

Dimensions (mm)

Fig. 1

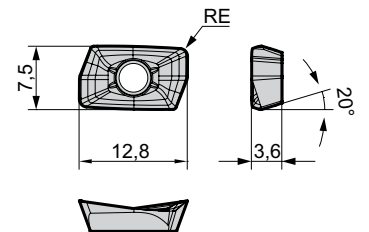
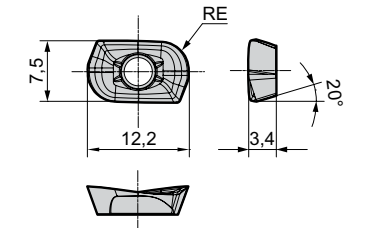

Fig. 2



L: Low cutting force  
G: General purpose  
H: Strong edge  
F: Finishing  
P: High-precision machining  
S: Non ferrous metals

\*P16 is applicable to cutter diameters Ø 14 mm and Ø 16 mm.

\*P20 is applicable to cutter diameters Ø 18 mm, Ø 20 mm.

\*P25 is applicable to cutter diameters Ø 25 mm, Ø 28 mm.



# "Wave Mill" Series

## WEZ 11000 EL

Rake Angle	Radial	-7° -- -18°	10 mm	90°
	Axial	6° -- 15°		



Fig. 1

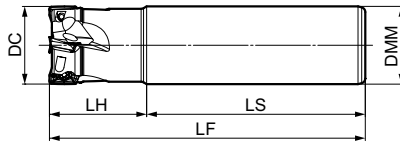
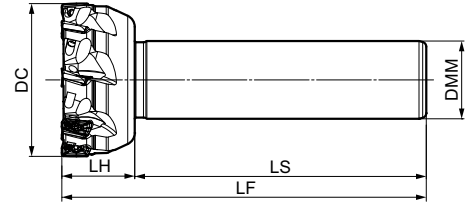

Fig. 2



### ■ Body - WEZ (Long Type)

Dimensions (mm)

Cat. No.	Stock	DC	DMM	LH	LS	LF	No. of Teeth	Weight (kg)	Fig.
WEZ 11014EL01	●	14	16	25	95	120	1	0,16	1
11016EL02	●	16	16	25	120	145	2	0,19	1
11016EL02-14	●	16	14	25	120	145	2	0,15	2
11018EL02	●	18	16	25	120	145	2	0,20	2
11020EL02	●	20	20	40	110	150	2	0,31	1
11020EL02-18	●	20	18	25	125	150	2	0,26	2
11022EL02	●	22	20	30	120	150	2	0,32	2
11025EL02	●	25	25	50	120	170	2	0,57	1
11025EL02-22	●	25	22	30	140	170	2	0,46	2
11025EL03	●	25	25	50	120	170	3	0,57	1
11028EL02	●	28	25	30	140	170	2	0,60	2
11030EL02	●	30	25	30	140	170	2	0,62	2
11032EL02	●	32	32	60	110	170	2	0,97	1
11032EL02-30	●	32	30	30	140	170	2	0,88	2
11032EL03	●	32	32	60	110	170	3	0,96	1
11035EL02	●	35	32	30	140	170	2	1,02	2
11035EL03	●	35	32	30	140	170	3	1,00	2
11040EL02	●	40	32	30	140	170	2	1,08	2
11050EL03	●	50	32	30	140	170	3	1,19	2

Inserts are sold separately.

### ■ Spare Parts

Applicable Cutters	Insert Screw		Wrench
WEZ 11014EL01	BFTX0305IP	2,0	TRDR08IP
11016EL02(-14)			
11018EL02			
11020EL02(-18)			
11022EL02			
11025EL02(-22)			
11025EL03			
11028EL02			
11030EL02			
11032EL02(-30)			
11032EL03			
11035EL02			
11035EL03			
11040EL02			
11050EL03			

### ■ Identification Details

<b>WEZ</b>	<b>11</b>	<b>025</b>	<b>E</b>	<b>L</b>	<b>02</b>	<b>- 22</b>
Cutter Series	Insert Size	Cutter Diameter	Round Shank	Long Type	Number of Teeth	Shank Diameter

\*When mounting inserts with nose radius of  $\geq 2,4$  mm, modification of the body is required.

Modify this edge.

Reworking guidelines  
 Corner radius = 2,4 mm: C = 1 mm (AOMT11T324PEER)  
 Corner radius = 3,0 mm: C = 1 mm (AOMT11T330PEER)  
 Corner radius = 3,2 mm: C = 1 mm (AOMT11T332PEER)  
 Standard: R = 1 mm

C: Chamfer  
 R: Radius

### ■ Recommended Cutting Conditions

→ H28

## Inserts

## Precautions for Mounting → H29

Application	Coated Carbide								Carbide	DLC	Cermets	RE	Fig.
	K	P	P	K	K	M	M	N					
High Speed / Light Cut													
General Purpose													
Roughing													
Cat. No.	ACU2500	XCU2500	ACP2000	ACP3000	XCK2000	ACK2000	ACK3000	ACM200	ACM300	H20	DL2000	T2500A	
AOMT 11T302PEER-G	●	○	□	●	○	□	●	●	●	-	-	●	0,2 1
11T304PEER-G	●	○	□	●	○	□	●	●	●	-	-	●	0,4 1
11T305PEER-G	●	○	□	●	○	□	●	●	●	-	-	●	0,5 1
11T308PEER-G	●	○	□	●	○	□	●	●	●	-	-	●	0,8 1
11T310PEER-G	●	○	□	●	○	□	●	●	●	-	-	□	1,0 1
11T312PEER-G	●	○	□	●	○	□	●	●	●	-	-	□	1,2 1
11T316PEER-G	●	○	□	●	○	□	●	●	●	-	-		1,6 1
11T320PEER-G	●	○	□	●	○	□	●	●	●	-	-		2,0 1
11T324PEER-G	●	○	□	●	○	□	●	●	●	-	-		2,4 1
11T330PEER-G	●	○	□	●	○	□	●	●	●	-	-		3,0 2
11T332PEER-G	●	○	□	●	○	□	●	●	●	-	-		3,2 2
AOMT 11T304PEER-H	●	○	□	●	○	□	●	●	●	-	-		0,4 1
11T308PEER-H	●	○	□	●	○	□	●	●	●	-	-		0,8 1
11T312PEER-H	●	○	□	●	○	□	●	●	●	-	-		1,2 1
11T316PEER-H	●	○	□	●	○	□	●	●	●	-	-		1,6 1
AOET 11T302PEER-F	●	-	-	-	-	-	-	-	-	-	-		0,2 1
11T304PEER-F	●	-	-	-	-	-	-	-	-	-	-		0,4 1
11T305PEER-F	●	-	-	-	-	-	-	-	-	-	-		0,5 1
11T308PEER-F	●	-	-	-	-	-	-	-	-	-	-		0,8 1
11T310PEER-F	●	-	-	-	-	-	-	-	-	-	-		1,0 1
11T312PEER-F	●	-	-	-	-	-	-	-	-	-	-		1,2 1
11T316PEER-F	●	-	-	-	-	-	-	-	-	-	-		1,6 1
11T320PEER-F	●	-	-	-	-	-	-	-	-	-	-		2,0 1
11T324PEER-F	●	-	-	-	-	-	-	-	-	-	-		2,4 1
11T330PEER-F	●	-	-	-	-	-	-	-	-	-	-		3,0 2
11T332PEER-F	●	-	-	-	-	-	-	-	-	-	-		3,2 2
AOET 11T302PEER-P16	●	-	-	-	-	-	-	-	-	-	-		0,2 1
11T304PEER-P16	●	-	-	-	-	-	-	-	-	-	-		0,4 1
11T305PEER-P16	●	-	-	-	-	-	-	-	-	-	-		0,5 1
11T308PEER-P16	●	-	-	-	-	-	-	-	-	-	-		0,8 1
11T310PEER-P16	●	-	-	-	-	-	-	-	-	-	-		1,0 1
11T312PEER-P16	●	-	-	-	-	-	-	-	-	-	-		1,2 1
11T302PEER-P20	●	-	-	-	-	-	-	-	-	-	-		0,2 1
11T304PEER-P20	●	-	-	-	-	-	-	-	-	-	-		0,4 1
11T305PEER-P20	●	-	-	-	-	-	-	-	-	-	-		0,5 1
11T308PEER-P20	●	-	-	-	-	-	-	-	-	-	-		0,8 1
11T310PEER-P20	●	-	-	-	-	-	-	-	-	-	-		1,0 1
11T312PEER-P20	●	-	-	-	-	-	-	-	-	-	-		1,2 1
11T302PEER-P25	●	-	-	-	-	-	-	-	-	-	-		0,2 1
11T304PEER-P25	●	-	-	-	-	-	-	-	-	-	-		0,4 1
11T305PEER-P25	●	-	-	-	-	-	-	-	-	-	-		0,5 1
11T308PEER-P25	●	-	-	-	-	-	-	-	-	-	-		0,8 1
11T310PEER-P25	●	-	-	-	-	-	-	-	-	-	-		1,0 1
11T312PEER-P25	●	-	-	-	-	-	-	-	-	-	-		1,2 1
AOET 11T302PEFR-S	-	-	-	-	-	-	-	-	●	●	-		0,2 1
11T304PEFR-S	-	-	-	-	-	-	-	-	●	●	-		0,4 1
11T305PEFR-S	-	-	-	-	-	-	-	-	●	●	-		0,5 1
11T308PEFR-S	-	-	-	-	-	-	-	-	●	●	-		0,8 1
11T310PEFR-S	-	-	-	-	-	-	-	-	●	●	-		1,0 1
11T312PEFR-S	-	-	-	-	-	-	-	-	●	●	-		1,2 1
11T316PEFR-S	-	-	-	-	-	-	-	-	●	●	-		1,6 1
11T320PEFR-S	-	-	-	-	-	-	-	-	●	●	-		2,0 1
11T324PEFR-S	-	-	-	-	-	-	-	-	●	●	-		2,4 1
11T330PEFR-S	-	-	-	-	-	-	-	-	●	●	-		3,0 2
11T332PEFR-S	-	-	-	-	-	-	-	-	●	●	-		3,2 2

Dimensions (mm)

Fig. 1

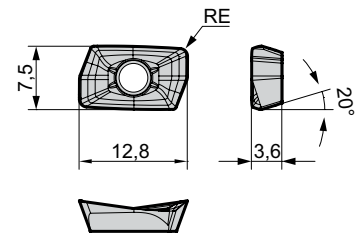
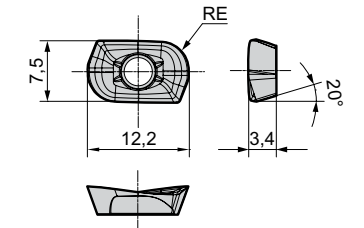

Fig. 2



L: Low cutting force  
G: General purpose  
H: Strong edge  
F: Finishing  
P: High-precision machining  
S: Non ferrous metals

\*P16 is applicable to cutter diameters Ø 14 mm and Ø 16 mm.

\*P20 is applicable to cutter diameters Ø 18 mm, Ø 20 mm.

\*P25 is applicable to cutter diameters Ø 25 mm, Ø 28 mm.

# "Wave Mill" Series

## WEZ 17000 E

Rake Angle	Radial	-6° - -12°	15 mm	90°
	Axial	6° - 15°		



Fig. 1

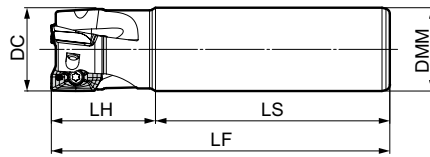
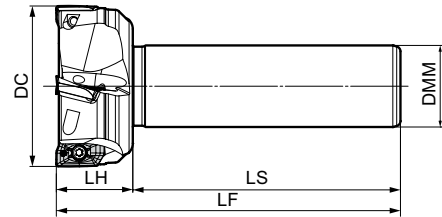

Fig. 2



### ■ Body - WEZ (Shank Type)

Dimensions (mm)

Cat. No.	Stock	DC	DMM	LH	LS	LF	No. of Teeth	Weight (kg)	Fig.
WEZ 17025E02	●	25	25	35	85	120	2	0,38	1
17025E02-20	●	25	20	35	85	120	2	0,25	2
17028E02	●	28	25	35	85	120	2	0,40	2
17030E03	●	30	25	40	90	130	3	0,43	2
17032E02	●	32	32	40	90	130	2	0,71	1
17032E03	●	32	32	40	90	130	3	0,69	1
17032E03-25	●	32	25	40	90	130	3	0,44	2
17035E03	●	35	32	40	90	130	3	0,72	2
17040E03	●	40	32	30	105	135	3	0,81	2
17040E04	●	40	32	30	105	135	4	0,79	2
17050E03	●	50	32	30	105	135	3	0,93	2
17050E03-42	●	50	42	30	105	135	3	1,41	2
17050E05	●	50	32	30	105	135	5	0,89	2
17050E05-42	●	50	42	30	105	135	5	1,37	2
17063E04	●	63	32	30	105	135	4	1,10	2
17063E04-42	●	63	42	30	105	135	4	1,58	2
17063E06	●	63	32	30	105	135	6	1,08	2
17063E06-42	●	63	42	30	105	135	6	1,56	2
17080E07	●	80	32	30	105	135	7	1,39	2

Inserts are sold separately.

### ■ Spare Parts

Applicable Cutters	Insert Screw		Wrench	
WEZ 17025E02(-20)	BFTX0407IP	3,0	TRDR15IP	
17028E02				
17030E03				
17032E02				
17032E03(-25)				
17035E03				
17040E03				
17040E04				
17050E03(-42)				
17050E05(-42)				
17063E04(-42)	BFTX0409IP	3,0	TRDR15IP	
17063E04(-42)				
17063E06(-42)				
17080E07				

### ■ Identification Details

<b>WEZ</b>	<b>17</b>	<b>032</b>	<b>E</b>	<b>02</b>	<b>- 30</b>
Cutter Series	Insert Size	Cutter Diameter	Round Shank	Number of Teeth	Shank Diameter

\*When mounting inserts with nose radius of  $\geq 2,4$  mm, modification of the body is required.



Modify this edge.

Reworking guidelines

Corner radius = 2,4 mm: C = 1 mm (AOMT170524PEER)

Corner radius = 3,0 mm: C = 1 mm (AOMT170530PEER)

Corner radius = 3,2 mm: C = 1 mm (AOMT170532PEER)

Corner radius = 4,0 mm: C = 2 mm (AOMT170540PEER)

Corner radius = 5,0 mm: C = 5 mm (AOMT170550PEER)

Corner radius = 6,4 mm: C = 5 mm (AOMT170564PEER)

Standard: R = 1 mm

Standard: R = 1 mm

Standard: R = 1 mm

Standard: R = 1 mm

Standard: R = 1 mm

Standard: R = 1 mm

Standard: R = 1 mm

Standard: R = 1 mm

Standard: R = 1 mm

Standard: R = 1 mm

Standard: R = 1 mm

Standard: R = 1 mm

Standard: R = 1 mm

Standard: R = 1 mm

Standard: R = 1 mm

Standard: R = 1 mm

Standard: R = 1 mm

Standard: R = 1 mm

### ■ Recommended Cutting Conditions

→ H28

## Inserts

Precautions for Mounting → H29

Application	Coated Carbide								Carbide	DLC	Cermets	RE	Fig.	
	KP	PM	P	K	K	MS	MS	MS						
High Speed / Light Cut											N	P		
General Purpose											N	N		
Roughing											N	N		
Cat. No.	ACU2500	XCU2500	ACP2000	ACP3000	XCK2000	ACK2000	ACK3000	ACM200	ACM300	H20	DL2000	T2500A		
AOMT 170502PEER-L	●			□				●	●				0,2	1
170504PEER-L	●	○		●	○			●	●			●	0,4	1
170508PEER-L	●	○		●	○			●	●			●	0,8	1
170512PEER-L	●			□				●	●				1,2	1
170516PEER-L	●			□				●	●				1,6	1
AOMT 170502PEER-G	●		□	●		□	●	●	●			□	0,2	1
170504PEER-G	●	○	□	●	○	●	●	●	●			●	0,4	1
170505PEER-G	●		□	□		□	□	●	●			□	0,5	1
170508PEER-G	●	○	●	●	○	●	●	●	●			●	0,8	1
170510PEER-G	●		□	□		□	□	●	●			□	1,0	1
170512PEER-G	●		□	●		□	●	●	●			□	1,2	1
170516PEER-G	●		□	●		□	●	●	●				1,6	1
170520PEER-G	●		□	●		□	●	●	●				2,0	1
170524PEER-G	●		□	□		□	□	●	●				2,4	1
170530PEER-G	●		□	●		□	●	●	●				3,0	1
170532PEER-G	●		□	●		□	●	●	●				3,2	1
170540PEER-G	●		□	●		□	●	●	●				4,0	1
170550PEER-G	●		□	●		□	●	●	●				5,0	2
170564PEER-G	□		□	□		□	□	●	●				6,4	2
AOMT 170504PEER-H	●	○	●	●	○	●	●	●	●				0,4	1
170508PEER-H	●	○	●	●	○	●	●	●	●				0,8	1
170512PEER-H	●		□	□		□	□	●	●				1,2	1
170516PEER-H	●		□	●		□	□	●	●				1,6	1
AOET 170502PEER-F	●												0,2	1
170504PEER-F	●												0,4	1
170505PEER-F	●												0,5	1
170508PEER-F	●												0,8	1
170510PEER-F	●												1,0	1
170512PEER-F	●												1,2	1
170516PEER-F	●												1,6	1
170520PEER-F	●												2,0	1
170524PEER-F	●												2,4	1
170530PEER-F	●												3,0	1
170532PEER-F	●												3,2	1
170540PEER-F	●												4,0	1
170550PEER-F	●												5,0	2
170564PEER-F	●												6,4	2
AOET 170502PEER-P25	●												0,2	1
170504PEER-P25	●												0,4	1
170505PEER-P25	●												0,5	1
170508PEER-P25	●												0,8	1
170510PEER-P25	●												1,0	1
170512PEER-P25	●												1,2	1
170502PEER-P32	●												0,2	1
170504PEER-P32	●												0,4	1
170505PEER-P32	●												0,5	1
170508PEER-P32	●												0,8	1
170510PEER-P32	●												1,0	1
170512PEER-P32	●												1,2	1
AOET 170502PEFR-S	-	-	-	-	-	-	-	-	●	●	-	-	0,2	1
170504PEFR-S	-	-	-	-	-	-	-	-	●	●	-	-	0,4	1
170505PEFR-S	-	-	-	-	-	-	-	-	●	●	-	-	0,5	1
170508PEFR-S	-	-	-	-	-	-	-	-	●	●	-	-	0,8	1
170510PEFR-S	-	-	-	-	-	-	-	-	●	●	-	-	1,0	1
170512PEFR-S	-	-	-	-	-	-	-	-	●	●	-	-	1,2	1
170516PEFR-S	-	-	-	-	-	-	-	-	●	●	-	-	1,6	1
170520PEFR-S	-	-	-	-	-	-	-	-	●	●	-	-	2,0	1
170524PEFR-S	-	-	-	-	-	-	-	-	●	●	-	-	2,4	1
170530PEFR-S	-	-	-	-	-	-	-	-	●	●	-	-	3,0	1
170532PEFR-S	-	-	-	-	-	-	-	-	●	●	-	-	3,2	1
170540PEFR-S	-	-	-	-	-	-	-	-	●	●	-	-	4,0	1
170550PEFR-S	-	-	-	-	-	-	-	-	●	●	-	-	5,0	2
170564PEFR-S	-	-	-	-	-	-	-	-	●	●	-	-	6,4	2

Dimensions (mm)

Fig. 1

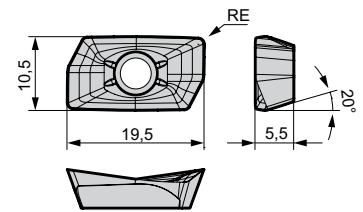
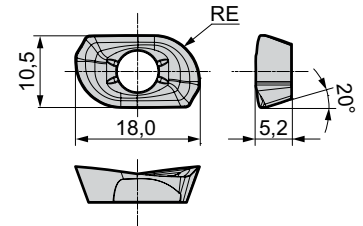

Fig. 2



L: Low cutting force  
G: General purpose  
H: Strong edge  
F: Finishing  
P: High-precision machining  
S: Non ferrous metals

\*P25 is applicable to cutter diameters Ø 25 mm and Ø 28 mm.  
\*P32 is applicable to cutter diameters Ø 30 mm, Ø 32 mm and Ø 35 mm.

# "Wave Mill" Series WEZ 17000 ES

Series for Multi-Tasking Machines

Rake Angle	Radial	-10° - -12°	15 mm	90°
	Axial	6° - 8°		



Fig. 1

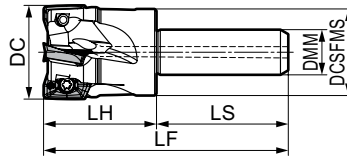

## Body - WEZ (Short Shank Type)

Dimensions (mm)

Cat. No.	Stock	DC	DCSFMS	DMM	LH	LS	LF	No. of Teeth	Weight (kg)	Fig.
WEZ 17025ES02-16	○	25	23	16	30	40	70	2	0,11	1
17032ES03-16	○	32	27	16	30	40	70	3	0,14	1

Inserts are sold separately.

## Spare Parts

Applicable Cutters	Insert Screw		Wrench
	WEZ 17025ES02-16 17032ES03-16		
	BFTX0407IP BFTX0409IP	3,0	TRDR15IP

## Identification Details

**WEZ 17 025 E S 02 - 16**

Cutter Series    Insert Size    Cutter Diameter    Round Shank    Short Shank    Number of Teeth    Shank Diameter

\*When mounting inserts with nose radius of  $\geq 2,4$  mm, modification of the body is required.



Modify this edge.

Reworking guidelines

- Corner radius = 2,4 mm: C = 1 mm (AOMT170524PEER)
- Corner radius = 3,0 mm: C = 1 mm (AOMT170530PEER)
- Corner radius = 3,2 mm: C = 1 mm (AOMT170532PEER)
- Corner radius = 4,0 mm: C = 2 mm (AOMT170540PEER)
- Corner radius = 5,0 mm: C = 5 mm (AOMT170550PEER)
- Corner radius = 6,4 mm: C = 5 mm (AOMT170564PEER)
- Standard: R = 1 mm

C: Chamfer  
R: Radius

## Recommended Cutting Conditions

→ H28

Tool: WEZ17025ES02-16  
Insert: AOET1705\_ PEER-F

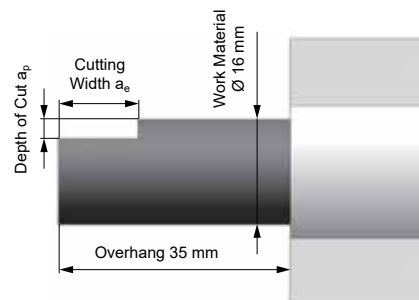
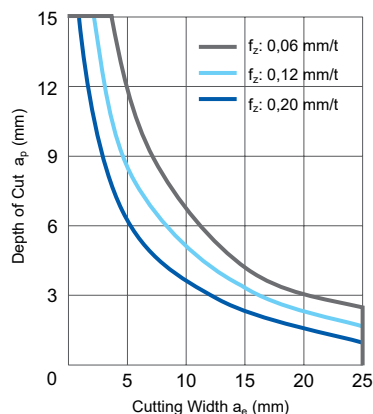

For cutting conditions by work material, see page 8.

When using G type chipbreakers, set the efficiency to 80%.

The recommended cutting conditions may not be practical depending on the operating conditions (e. g. machine, work material shape, clamping system).

## Inserts

## Precautions for Mounting → H29

Application	Coated Carbide								Carbide	DLC	Cermets	RE	Fig.	
	KP	PM	P	K	K	MS	MS	MS						
High Speed / Light Cut														
General Purpose														
Roughing														
Cat. No.	ACU2500	XCU2500	ACP2000	ACP3000	XCK2000	ACK2000	ACK3000	ACM200	ACM300	H20	DL2000	T2500A		
AOMT 170502PEER-L	●			□				●	●				0,2	1
170504PEER-L	●	○		●	○			●	●				0,4	1
170508PEER-L	●	○		●	○			●	●				0,8	1
170512PEER-L	●			□				●	●				1,2	1
170516PEER-L	●			□				●	●				1,6	1
AOMT 170502PEER-G	●		□	●		□	●	●	●			□	0,2	1
170504PEER-G	●	○	□	●	○	□	●	●	●			□	0,4	1
170505PEER-G	●		□	□		□	□	●	●			□	0,5	1
170508PEER-G	●	○	□	●	○	□	●	●	●			□	0,8	1
170510PEER-G	●		□	□		□	□	●	●			□	1,0	1
170512PEER-G	●		□	●		□	●	●	●			□	1,2	1
170516PEER-G	●		□	●		□	●	●	●				1,6	1
170520PEER-G	●		□	●		□	●	●	●				2,0	1
170524PEER-G	●		□	□		□	□	●	●				2,4	1
170530PEER-G	●		□	□		□	□	●	●				3,0	1
170532PEER-G	●		□	□		□	□	●	●				3,2	1
170540PEER-G	●		□	□		□	□	●	●				4,0	1
170550PEER-G	●		□	□		□	□	●	●				5,0	2
170564PEER-G	□		□	□		□	□	●	●				6,4	2
AOMT 170504PEER-H	●	○	●	●	○	●	●	●	●				0,4	1
170508PEER-H	●	○	●	●	○	●	●	●	●				0,8	1
170512PEER-H	●		□	□		□	□	●	●				1,2	1
170516PEER-H	●		□	□		□	□	●	●				1,6	1
AOET 170502PEER-F	●												0,2	1
170504PEER-F	●												0,4	1
170505PEER-F	●												0,5	1
170508PEER-F	●												0,8	1
170510PEER-F	●												1,0	1
170512PEER-F	●												1,2	1
170516PEER-F	●												1,6	1
170520PEER-F	●												2,0	1
170524PEER-F	●												2,4	1
170530PEER-F	●												3,0	1
170532PEER-F	●												3,2	1
170540PEER-F	●												4,0	1
170550PEER-F	●												5,0	2
170564PEER-F	●												6,4	2
AOET 170502PEER-P25	●												0,2	1
170504PEER-P25	●												0,4	1
170505PEER-P25	●												0,5	1
170508PEER-P25	●												0,8	1
170510PEER-P25	●												1,0	1
170512PEER-P25	●												1,2	1
170502PEER-P32	●												0,2	1
170504PEER-P32	●												0,4	1
170505PEER-P32	●												0,5	1
170508PEER-P32	●												0,8	1
170510PEER-P32	●												1,0	1
170512PEER-P32	●												1,2	1
AOET 170502PEFR-S	-	-	-	-	-	-	-	-	●	●	-	-	0,2	1
170504PEFR-S	-	-	-	-	-	-	-	-	●	●	-	-	0,4	1
170505PEFR-S	-	-	-	-	-	-	-	-	●	●	-	-	0,5	1
170508PEFR-S	-	-	-	-	-	-	-	-	●	●	-	-	0,8	1
170510PEFR-S	-	-	-	-	-	-	-	-	●	●	-	-	1,0	1
170512PEFR-S	-	-	-	-	-	-	-	-	●	●	-	-	1,2	1
170516PEFR-S	-	-	-	-	-	-	-	-	●	●	-	-	1,6	1
170520PEFR-S	-	-	-	-	-	-	-	-	●	●	-	-	2,0	1
170524PEFR-S	-	-	-	-	-	-	-	-	●	●	-	-	2,4	1
170530PEFR-S	-	-	-	-	-	-	-	-	●	●	-	-	3,0	1
170532PEFR-S	-	-	-	-	-	-	-	-	●	●	-	-	3,2	1
170540PEFR-S	-	-	-	-	-	-	-	-	●	●	-	-	4,0	1
170550PEFR-S	-	-	-	-	-	-	-	-	●	●	-	-	5,0	2
170564PEFR-S	-	-	-	-	-	-	-	-	●	●	-	-	6,4	2

Dimensions (mm)

Fig. 1

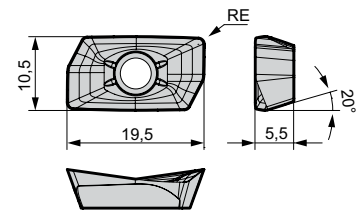
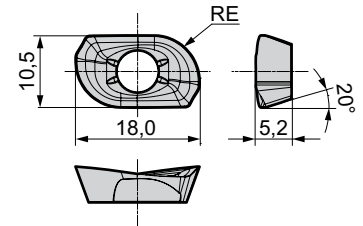

Fig. 2



L: Low cutting force  
G: General purpose  
H: Strong edge  
F: Finishing  
P: High-precision machining  
S: Non ferrous metals

\*P25 is applicable to cutter diameters Ø 25 mm and Ø 28 mm.  
\*P32 is applicable to cutter diameters Ø 30 mm, Ø 32 mm and Ø 35 mm.



# "Wave Mill" Series

## WEZ 17000 EL

Rake Angle	Radial	-6° - -12°	15 mm	90°
	Axial	6° - 15°		

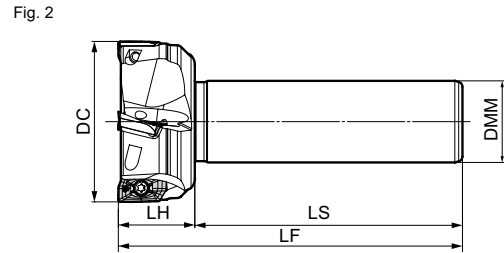
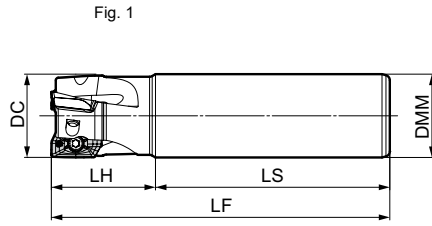

### Body - WEZ (Long Type)

Dimensions (mm)

Cat. No.	Stock	DC	DMM	LH	LS	LF	No. of Teeth	Weight (kg)	Fig.
WEZ 17025EL02	●	25	25	50	120	170	2	0,55	1
17028EL02	●	28	25	50	120	170	2	0,57	2
17030EL02	●	30	25	50	120	170	2	0,59	2
17032EL02	●	32	32	60	110	170	2	0,94	1
17032EL02-30	●	32	30	50	120	170	2	0,85	2
17032EL03	●	32	32	60	110	170	3	0,92	1
17035EL02	●	35	32	50	120	170	2	0,98	2
17040EL02	●	40	32	50	120	170	2	1,09	2
17040EL03	●	40	32	50	120	170	3	1,08	2
17040EL04	●	40	32	50	120	170	4	1,05	2
17050EL03	●	50	32	50	120	170	3	1,29	2
17050EL03-42	●	50	42	50	120	170	3	1,83	2
17050EL05	●	50	32	50	120	170	5	1,25	2
17050EL05-42	●	50	42	50	120	170	5	1,79	2
17063EL04	●	63	32	50	120	170	4	1,61	2
17063EL04-42	●	63	42	50	120	170	4	2,16	2
17063EL06	●	63	32	50	120	170	6	1,58	2
17063EL06-42	●	63	42	50	120	170	6	2,13	2

Inserts are sold separately.

### Spare Parts

Applicable Cutters	Insert Screw		Wrench
WEZ 17025EL02 17028EL02 17030EL02 17032EL02(-30) 17032EL03 17035EL02 17040EL02 17040EL03 17040EL04 17050EL03(-42) 17050EL05(-42) 17063EL04(-42) 17063EL06(-42)	BFTX0407IP	3,0	TRDR15IP
	BFTX0409IP		

### Identification Details

**WEZ 17 032 E L 02 - 30**

Cutter Series    Insert Size    Cutter Diameter    Round Shank    Long Type    Number of Teeth    Shank Diameter

\*When mounting inserts with nose radius of  $\geq 2,4$  mm, modification of the body is required.

Modify this edge.

Reworking guidelines  
 Corner radius = 2,4 mm: C = 1 mm (AOMT170524PEER)  
 Corner radius = 3,0 mm: C = 1 mm (AOMT170530PEER)  
 Corner radius = 3,2 mm: C = 1 mm (AOMT170532PEER)  
 Corner radius = 4,0 mm: C = 2 mm (AOMT170540PEER)  
 Corner radius = 5,0 mm: C = 5 mm (AOMT170550PEER)  
 Corner radius = 6,4 mm: C = 5 mm (AOMT170564PEER)  
 Standard: R = 1 mm

### Recommended Cutting Conditions

→ H28

## Inserts

## Precautions for Mounting → H29

Application	Coated Carbide								Carbide	DLC	Cermets	RE	Fig.	
	KP	PM	P	K	K	MS	MS	MS						
High Speed / Light Cut										N	P			
General Purpose										N	N			
Roughing										N	N			
Cat. No.	ACU2500	XCU2500	ACP2000	ACP3000	XCK2000	ACK2000	ACK3000	ACM200	ACM300	H20	DL2000	T2500A		
AOMT 170502PEER-L	●			□				●	●				0,2	1
170504PEER-L	●	○		●	○			●	●			●	0,4	1
170508PEER-L	●	○		●	○			●	●			●	0,8	1
170512PEER-L	●			□				●	●				1,2	1
170516PEER-L	●			□				●	●				1,6	1
AOMT 170502PEER-G	●		□	●		□		●	●			□	0,2	1
170504PEER-G	●	○	□	●	○	□		●	●			□	0,4	1
170505PEER-G	●		□	□		□		●	●			□	0,5	1
170508PEER-G	●	○	□	●	○	□		●	●			□	0,8	1
170510PEER-G	●		□	□		□		●	●			□	1,0	1
170512PEER-G	●		□	●		□		●	●			□	1,2	1
170516PEER-G	●		□	●		□		●	●				1,6	1
170520PEER-G	●		□	●		□		●	●				2,0	1
170524PEER-G	●		□	□		□		●	●				2,4	1
170530PEER-G	●		□	□		□		●	●				3,0	1
170532PEER-G	●		□	□		□		●	●				3,2	1
170540PEER-G	●		□	□		□		●	●				4,0	1
170550PEER-G	●		□	□		□		●	●				5,0	2
170564PEER-G	□		□	□		□		●	●				6,4	2
AOMT 170504PEER-H	●	○	●	●	○	●		●	●				0,4	1
170508PEER-H	●	○	●	●	○	●		●	●				0,8	1
170512PEER-H	●		□	□		□		●	●				1,2	1
170516PEER-H	●		□	□		□		●	●				1,6	1
AOET 170502PEER-F	●												0,2	1
170504PEER-F	●												0,4	1
170505PEER-F	●												0,5	1
170508PEER-F	●												0,8	1
170510PEER-F	●												1,0	1
170512PEER-F	●												1,2	1
170516PEER-F	●												1,6	1
170520PEER-F	●												2,0	1
170524PEER-F	●												2,4	1
170530PEER-F	●												3,0	1
170532PEER-F	●												3,2	1
170540PEER-F	●												4,0	1
170550PEER-F	●												5,0	2
170564PEER-F	●												6,4	2
AOET 170502PEER-P25	●												0,2	1
170504PEER-P25	●												0,4	1
170505PEER-P25	●												0,5	1
170508PEER-P25	●												0,8	1
170510PEER-P25	●												1,0	1
170512PEER-P25	●												1,2	1
170502PEER-P32	●												0,2	1
170504PEER-P32	●												0,4	1
170505PEER-P32	●												0,5	1
170508PEER-P32	●												0,8	1
170510PEER-P32	●												1,0	1
170512PEER-P32	●												1,2	1
AOET 170502PEFR-S	-	-	-	-	-	-	-	●	●				0,2	1
170504PEFR-S	-	-	-	-	-	-	-	●	●				0,4	1
170505PEFR-S	-	-	-	-	-	-	-	●	●				0,5	1
170508PEFR-S	-	-	-	-	-	-	-	●	●				0,8	1
170510PEFR-S	-	-	-	-	-	-	-	●	●				1,0	1
170512PEFR-S	-	-	-	-	-	-	-	●	●				1,2	1
170516PEFR-S	-	-	-	-	-	-	-	●	●				1,6	1
170520PEFR-S	-	-	-	-	-	-	-	●	●				2,0	1
170524PEFR-S	-	-	-	-	-	-	-	●	●				2,4	1
170530PEFR-S	-	-	-	-	-	-	-	●	●				3,0	1
170532PEFR-S	-	-	-	-	-	-	-	●	●				3,2	1
170540PEFR-S	-	-	-	-	-	-	-	●	●				4,0	1
170550PEFR-S	-	-	-	-	-	-	-	●	●				5,0	2
170564PEFR-S	-	-	-	-	-	-	-	●	●				6,4	2

Dimensions (mm)

Fig. 1

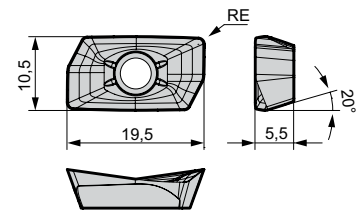
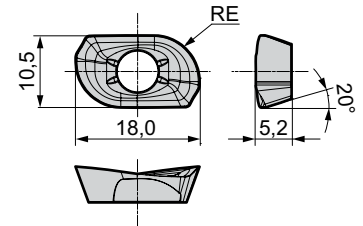

Fig. 2



L: Low cutting force  
G: General purpose  
H: Strong edge  
F: Finishing  
P: High-precision machining  
S: Non ferrous metals

\*P25 is applicable to cutter diameters Ø 25 mm and Ø 28 mm.  
\*P32 is applicable to cutter diameters Ø 30 mm, Ø 32 mm and Ø 35 mm.

# "Wave Mill" Series WEZR 11000 E

**New**

Repeater Type

Rake Angle	Radial	-15° - -11°	19-61 mm	90°
	Axial	8° - 14°		

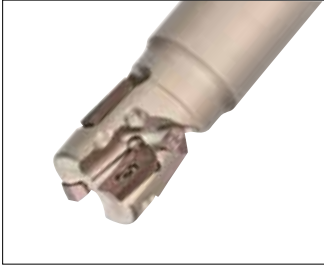

Fig. 1

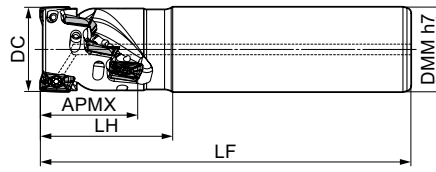
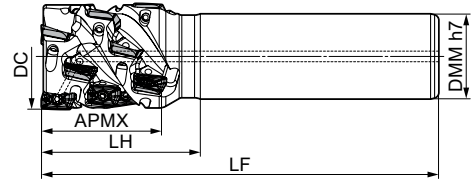

Fig. 2



## Body (Shank Type)

Dimensions (mm)

Cat. No.	Stock	DC	APMX	DMM	LH	LF	Total No. of Teeth	Steps	Effective No. of Teeth	Weight (kg)	Fig.
WEZR 11020E1920Z02	○	20	19	20	30	110	4	2	2	0,22	1
11020E3620Z01	○	20	36	20	45	125	4	4	1	0,24	1
11025E2725Z02	○	25	27	25	40	130	6	3	2	0,41	1
11025E3625Z02	○	25	36	25	50	140	8	4	2	0,42	1
11030E5325Z02	○	30	53	25	65	155	12	6	2	0,52	2
11032E3632Z02	○	32	36	32	50	140	8	4	2	0,74	1
11032E3632Z03	○	32	36	32	50	140	12	4	3	0,71	1
11032E5332Z02	○	32	53	32	70	160	12	6	2	0,90	1
11035E5332Z03	○	35	53	32	65	155	18	6	3	0,88	2
11040E4432Z03	○	40	44	32	60	150	15	5	3	0,87	2
11040E4432Z04	○	40	44	32	60	150	20	5	4	0,85	2
11040E6132Z03	○	40	61	32	75	165	21	7	3	0,95	2

Inserts are sold separately.

## Spare Parts

Applicable Cutters	Insert Screw		Wrench
WEZR 11_ _ _	BFTX0306IP	1,5	TRDR08IP

## Recommended Cutting Conditions

ISO	Work Material	Hardness (HB)	Chipbreaker	Cutting Speed v <sub>c</sub> (m/min)	Feed Rate f <sub>z</sub> (mm/t)	Grades
P	Carbon Steel	≤ 280HB	G	100-150-200	0,08-0,12-0,20	ACU2500 XCU2500
		> 280HB	G	80-100-120	0,08-0,12-0,20	ACP2000 ACP3000
	Alloy Steel	≤ 280HB	G	100-150-80	0,08-0,12-0,20	ACP3000
M	Stainless Steel	≤ 280HB	G	80-120-160	0,08-0,12-0,20	ACU2500 ACM200 ACM300
K	Cast Iron Ductile Cast Iron	-	G	100-150-200	0,08-0,12-0,20	ACU2500 XGK2000 ACK2000 ACK3000
S	Exotic Alloy	-	G	40-50-60	0,08-0,12-0,20	ACU2500 ACM200 ACM300
N	Aluminum Alloy	Si ≤ 12,6%	S	300-500-800	0,05-0,10-0,15	DL2000
		Si > 12,6%	S	100-200-250	0,05-0,10-0,15	H20

Min. - Optimum - Max.

Note:

The cutting conditions above are a guide. Actual conditions will need to be adjusted according to machine rigidity, work clamp rigidity, depth of cut and other factors. There may be cases where machining cannot be performed under recommended cutting conditions, depending on the machine rigidity and work rigidity.

## Identification Details

**WEZR 11 032 E 36 32 Z02**

Cutter Series	Insert Size	Cutter Diameter	Shank Type	Max. Depth of Cut	Shank Diameter	Effective Number of Teeth
WEZR 11	032	E	36	32	Z02	

\*When mounting inserts with nose radius of ≥ 2,4 mm, modification of the body is required.



Modify this edge.

Reworking guidelines

Corner radius = 2,4 mm: C = 1 mm

(AOMT11T324PEER)

Corner radius = 3,0 mm: C = 1 mm

(AOMT11T330PEER)

Corner radius = 3,2 mm: C = 1 mm

(AOMT11T332PEER)

Standard: R = 1 mm

C: Chamfer

R: Radius

# "Wave Mill" Series WEZR 11000 E

## ■ Inserts

Precautions for Mounting → H29

Application	Coated Carbide								Carbide	DLC	Cermets	Dimensions (mm)		
	P	K	M	S	P	K	M	S						
High Speed / Light Cut														
General Purpose														
Roughing														
Cat. No.	ACU2500	XCU2500	ACP2000	ACP3000	XCK2000	ACK2000	ACK3000	ACM200	ACM300	H20	DL2000	T2500A	RE	Fig.
AOMT 11T302PEER-G	●		□	●	○	□	●	●	●	-	-	-	0,2	1
11T304PEER-G	●	○	□	●	○	□	●	●	●	-	-	-	0,4	1
11T305PEER-G	●		□	□		□	●	●	●	-	-	□	0,5	1
11T308PEER-G	●	○	●	●	○	●	●	●	●	-	-	●	0,8	1
11T310PEER-G	●		□	□		□	□	●	●	-	-	□	1,0	1
11T312PEER-G	●		□	●		□	●	●	●	-	-	□	1,2	1
11T316PEER-G	●		□	●		□	●	●	●	-	-	-	1,6	1
11T320PEER-G	●		□	●		□	●	●	●	-	-	-	2,0	1
11T324PEER-G	●		□	□		□	□	●	●	-	-	-	2,4	1
11T330PEER-G	●		□	●		□	●	●	●	-	-	-	3,0	2
11T332PEER-G	●		□	□		□	□	●	●	-	-	-	3,2	2
AOMT 11T304PEER-H	●	○	●	●	○	●	●	●	●	-	-	-	0,4	1
11T308PEER-H	●	○	●	●	○	●	●	●	●	-	-	-	0,8	1
11T312PEER-H	●		□	□		□	□	●	●	-	-	-	1,2	1
11T316PEER-H	●		□	□		□	□	●	●	-	-	-	1,6	1
AOET 11T302PEER-F	●		-	-	-	-	-	-	-	-	-	-	0,2	1
11T304PEER-F	●		-	-	-	-	-	-	-	-	-	-	0,4	1
11T305PEER-F	●		-	-	-	-	-	-	-	-	-	-	0,5	1
11T308PEER-F	●		-	-	-	-	-	-	-	-	-	-	0,8	1
11T310PEER-F	●		-	-	-	-	-	-	-	-	-	-	1,0	1
11T312PEER-F	●		-	-	-	-	-	-	-	-	-	-	1,2	1
11T316PEER-F	●		-	-	-	-	-	-	-	-	-	-	1,6	1
11T320PEER-F	●		-	-	-	-	-	-	-	-	-	-	2,0	1
11T324PEER-F	●		-	-	-	-	-	-	-	-	-	-	2,4	1
11T330PEER-F	●		-	-	-	-	-	-	-	-	-	-	3,0	2
11T332PEER-F	●		-	-	-	-	-	-	-	-	-	-	3,2	2
AOET 11T302PEER-P20	●		-	-	-	-	-	-	-	-	-	-	0,2	1
11T304PEER-P20	●		-	-	-	-	-	-	-	-	-	-	0,4	1
11T305PEER-P20	●		-	-	-	-	-	-	-	-	-	-	0,5	1
11T308PEER-P20	●		-	-	-	-	-	-	-	-	-	-	0,8	1
11T310PEER-P20	●		-	-	-	-	-	-	-	-	-	-	1,0	1
11T312PEER-P20	●		-	-	-	-	-	-	-	-	-	-	1,2	1
11T302PEER-P25	●		-	-	-	-	-	-	-	-	-	-	0,2	1
11T304PEER-P25	●		-	-	-	-	-	-	-	-	-	-	0,4	1
11T305PEER-P25	●		-	-	-	-	-	-	-	-	-	-	0,5	1
11T308PEER-P25	●		-	-	-	-	-	-	-	-	-	-	0,8	1
11T310PEER-P25	●		-	-	-	-	-	-	-	-	-	-	1,0	1
11T312PEER-P25	●		-	-	-	-	-	-	-	-	-	-	1,2	1
AOET 11T302PEFR-S	-	-	-	-	-	-	-	●	●	-	-	-	0,2	1
11T304PEFR-S	-	-	-	-	-	-	-	●	●	-	-	-	0,4	1
11T305PEFR-S	-	-	-	-	-	-	-	●	●	-	-	-	0,5	1
11T308PEFR-S	-	-	-	-	-	-	-	●	●	-	-	-	0,8	1
11T310PEFR-S	-	-	-	-	-	-	-	●	●	-	-	-	1,0	1
11T312PEFR-S	-	-	-	-	-	-	-	●	●	-	-	-	1,2	1
11T316PEFR-S	-	-	-	-	-	-	-	●	●	-	-	-	1,6	1
11T320PEFR-S	-	-	-	-	-	-	-	●	●	-	-	-	2,0	1
11T324PEFR-S	-	-	-	-	-	-	-	●	●	-	-	-	2,4	1
11T330PEFR-S	-	-	-	-	-	-	-	●	●	-	-	-	3,0	2
11T332PEFR-S	-	-	-	-	-	-	-	●	●	-	-	-	3,2	2

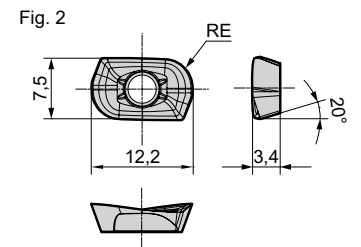
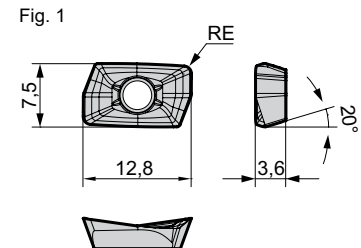

L: Low cutting force  
G: General purpose  
H: Strong edge  
F: Finishing  
P: High-precision machining  
S: Non ferrous metals

\*P20 is applicable to cutter diameters Ø 18 mm, Ø 20 mm.  
\*P25 is applicable to cutter diameters Ø 25 mm, Ø 28 mm.

Use peripheral inserts with RE ≤ 0,8 mm from the second step and above.

# "Wave Mill" Series WEZR 17000 E

**New**

Repeater Type

Rake Angle	Radial	-9° - -8°	29-84 mm	90°
	Axial	10° - 12°		

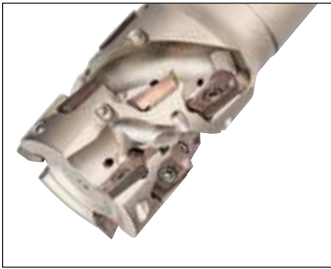
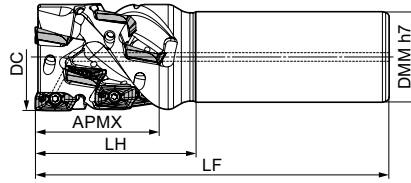

Fig. 1





## Body (Shank Type)

Dimensions (mm)

Cat. No.	Stock	DC	APMX	DMM	LH	LF	Total No. of Teeth	Steps	Effective No. of Teeth	Weight (kg)	Fig.
WEZR 17040E2932Z03	○	40	29	32	45	110	6	3	2	0,75	1
17040E4332Z02	○	40	43	32	60	125	6	2	3	0,86	1
17050E5742Z03	○	50	57	42	75	130	12	3	4	1,58	1
17050E8442Z02	○	50	84	42	105	140	12	2	6	1,04	1

Inserts are sold separately.

## Spare Parts

Applicable Cutters	Insert Screw		Wrench
			
WEZR 17_ _ _	BFTX0409IP	3,0	TRDR15IP

## Recommended Cutting Conditions

ISO	Work Material	Hardness (HB)	Chipbreaker	Cutting Speed $v_c$ (m/min)	Feed Rate $f_z$ (mm/t)	Grades
P	Carbon Steel	≤ 280HB	G	100-150-200	0,10-0,20-0,30	ACU2500 XCU2500
		> 280HB	G	80-100-120	0,10-0,20-0,30	ACP2000 ACP3000
	Alloy Steel	≤ 280HB	G	100-150-80	0,10-0,20-0,30	
M	Stainless Steel	≤ 280HB	G	80-120-160	0,10-0,20-0,30	ACU2500 ACM200 ACM300
K	Cast Iron Ductile Cast Iron	-	G	100-150-200	0,10-0,20-0,30	ACU2500 XCK2000 ACK2000 ACK3000
S	Exotic Alloy	-	G	40-50-60	0,10-0,20-0,30	ACU2500 ACM200 ACM300
N	Aluminum Alloy	Si ≤ 12,6%	S	300-500-800	0,05-0,10-0,15	DL2000
		Si > 12,6%	S	100-200-250	0,05-0,10-0,15	H20

Min. - Optimum - Max.

Note:

The cutting conditions above are a guide. Actual conditions will need to be adjusted according to machine rigidity, work clamp rigidity, depth of cut and other factors.

There may be cases where machining cannot be performed under recommended cutting conditions, depending on the machine rigidity and work rigidity.

## Identification Details

**WEZR 17 040 E 29 32 Z03**

Cutter Series	Insert Size	Cutter Diameter	Shank Type	Max. Depth of Cut	Shank Diameter	Effective Number of Teeth
WEZR	17	040	E	29	32	Z03

\*When mounting inserts with nose radius of  $\geq 2,4$  mm, modification of the body is required.



Modify this edge.

Reworking guidelines  
 Corner radius = 2,4 mm: C = 1 mm (AOMT170524PEER)  
 Corner radius = 3,0 mm: C = 1 mm (AOMT170530PEER)  
 Corner radius = 3,2 mm: C = 1 mm (AOMT170532PEER)  
 Corner radius = 4,0 mm: C = 2 mm (AOMT170540PEER)  
 Corner radius = 5,0 mm: C = 5 mm (AOMT170550PEER)  
 Corner radius = 6,4 mm: C = 5 mm (AOMT170564PEER)  
 Standard: R = 1 mm

C: Chamfer  
R: Radius

# "Wave Mill" Series WEZR 17000 E

## ■ Inserts

## Precautions for Mounting

→ H29

Application	Coated Carbide								Carbide	DLC	Cermets	Dimensions (mm)		
	P	K	M	S	P	K	K	M						
High Speed / Light Cut														
General Purpose														
Roughing														
Cat. No.	ACU2500	XCU2500	ACP2000	ACP3000	XCK2000	ACK2000	ACK3000	ACM200	ACM300	H20	DL2000	T2500A	RE	Fig.
AOMT 170502PEER-L	●			□			●	●				□	0,2	1
170504PEER-L	●	○		●	○		●	●				●	0,4	1
170508PEER-L	●	○		●	○		●	●				●	0,8	1
170512PEER-L	●			□			●	●					1,2	1
170516PEER-L	●			□			●	●					1,6	1
AOMT 170502PEER-G	●		□	●		□	●	●				□	0,2	1
170504PEER-G	●	○	●	●	○	●	●	●				●	0,4	1
170505PEER-G	●		□	□		□	●	●				□	0,5	1
170508PEER-G	●	○	●	●	○	●	●	●				●	0,8	1
170510PEER-G	●		□	□		□	●	●				□	1,0	1
170512PEER-G	●		□	●		□	●	●				□	1,2	1
170516PEER-G	●		□	●		□	●	●					1,6	1
170520PEER-G	●		□	●		□	●	●					2,0	1
170524PEER-G	●		□	●		□	●	●					2,4	1
170530PEER-G	●		□	●		□	●	●					3,0	1
170532PEER-G	●		□	□		□	●	●					3,2	1
170540PEER-G	●		□	●		□	●	●					4,0	1
170550PEER-G	●		□	●		□	●	●					5,0	2
170564PEER-G	□		□	□		□	●	●					6,4	2
AOMT 170504PEER-H	●	○	●	●	○	●	●	●					0,4	1
170508PEER-H	●	○	●	●	○	●	●	●					0,8	1
170512PEER-H	●		□	□		□	●	●					1,2	1
170516PEER-H	●		□	●		□	●	●					1,6	1
AOET 170502PEER-F	●												0,2	1
170504PEER-F	●												0,4	1
170505PEER-F	●												0,5	1
170508PEER-F	●												0,8	1
170510PEER-F	●												1,0	1
170512PEER-F	●												1,2	1
170516PEER-F	●												1,6	1
170520PEER-F	●												2,0	1
170524PEER-F	●												2,4	1
170530PEER-F	●												3,0	1
170532PEER-F	●												3,2	1
170540PEER-F	●												4,0	1
170550PEER-F	●												5,0	2
170564PEER-F	●												6,4	2
AOET 170502PEFR-S	-	-	-	-	-	-	-	-	●	●			0,2	1
170504PEFR-S	-	-	-	-	-	-	-	-	●	●			0,4	1
170505PEFR-S	-	-	-	-	-	-	-	-	●	●			0,5	1
170508PEFR-S	-	-	-	-	-	-	-	-	●	●			0,8	1
170510PEFR-S	-	-	-	-	-	-	-	-	●	●			1,0	1
170512PEFR-S	-	-	-	-	-	-	-	-	●	●			1,2	1
170516PEFR-S	-	-	-	-	-	-	-	-	●	●			1,6	1
170520PEFR-S	-	-	-	-	-	-	-	-	●	●			2,0	1
170524PEFR-S	-	-	-	-	-	-	-	-	●	●			2,4	1
170530PEFR-S	-	-	-	-	-	-	-	-	●	●			3,0	1
170532PEFR-S	-	-	-	-	-	-	-	-	●	●			3,2	1
170540PEFR-S	-	-	-	-	-	-	-	-	●	●			4,0	1
170550PEFR-S	-	-	-	-	-	-	-	-	●	●			5,0	2
170564PEFR-S	-	-	-	-	-	-	-	-	●	●			6,4	2

Dimensions (mm)

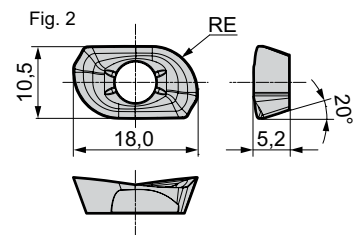
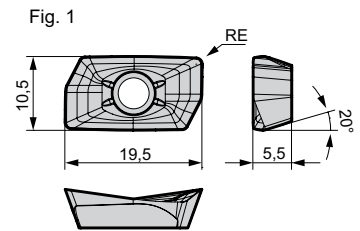

L: Low cutting force  
G: General purpose  
H: Strong edge  
F: Finishing  
P: High-precision machining  
S: Non ferrous metals

Use peripheral inserts with RE ≤ 0,8 mm from the second step and above.



# "Wave Mill" Series WEZ 11000 M

## Modular Type

Rake Angle	Radial	-7° -- -18°	10 mm	90°
	Axial	6° -- 15°		



Fig. 1

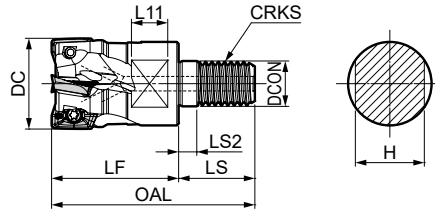

### Head

Dimensions (mm)

Cat. No.	Stock	DC	DCON	CRKS	OAL	LF	LS2	L11	H	No. of Teeth	Weight (kg)	Fig.
WEZ 11016M08Z2	●	16	8,5	M8	42	25	5	8	13	2	0,03	1
11018M08Z2	●	18	8,5	M8	42	25	5	8	13	2	0,03	1
11020M10Z2	●	20	10,5	M10	49	30	5	8	15	2	0,06	1
11020M10Z3	●	20	10,5	M10	49	30	5	8	15	3	0,05	1
11022M10Z3	●	22	10,5	M10	49	30	5	8	15	3	0,06	1
11025M12Z2	●	25	12,5	M12	56	35	5	10	19	2	0,11	1
11025M12Z3	●	25	12,5	M12	56	35	5	10	19	3	0,10	1
11025M12Z4	●	25	12,5	M12	56	35	5	10	19	4	0,10	1
11026M12Z4	●	26	12,5	M12	56	35	5	10	19	4	0,10	1
11026M12Z5	●	26	12,5	M12	56	35	5	10	19	5	0,09	1
11028M12Z4	●	28	12,5	M12	56	35	5	10	19	4	0,11	1
11028M12Z5	●	28	12,5	M12	56	35	5	10	19	5	0,10	1
11030M16Z2	●	30	17	M16	63	40	5	10	24	2	0,20	1
11030M16Z4	●	30	17	M16	63	40	5	10	24	4	0,19	1
11030M16Z5	●	30	17	M16	63	40	5	10	24	5	0,17	1
11032M16Z2	●	32	17	M16	63	40	5	10	24	2	0,22	1
11032M16Z3	●	32	17	M16	63	40	5	10	24	3	0,20	1
11032M16Z4	●	32	17	M16	63	40	5	10	24	4	0,20	1
11032M16Z5	●	32	17	M16	63	40	5	10	24	5	0,19	1
11035M16Z2	●	35	17	M16	63	40	5	10	24	2	0,24	1
11035M16Z5	●	35	17	M16	63	40	5	10	24	5	0,22	1
11040M16Z2	●	40	17	M16	63	40	5	10	24	2	0,28	1
11040M16Z4	●	40	17	M16	63	40	5	10	24	4	0,26	1
11040M16Z5	●	40	17	M16	63	40	5	10	24	5	0,26	1
11040M16Z6	●	40	17	M16	63	40	5	10	24	6	0,25	1

Inserts are sold separately. Arbor → H5.

### Spare Parts

Applicable Cutters	Insert Screw		Wrench
	WEZ 11016M08Z2 11018M08Z2 11020M10Z2-11040M16Z2	BFTX0305IP BFTX0306IP	1,5

### Recommended Cutting Conditions

→ H. 28

### Identification Details

<b>WEZ</b>	<b>11</b>	<b>016</b>	<b>M 08</b>	<b>Z2</b>
Cutter Series	Insert Size	Cutter Diameter	Mounting Screw Size	Number of Teeth

\*When mounting inserts with nose radius of  $\geq 2,4$  mm, modification of the body is required.

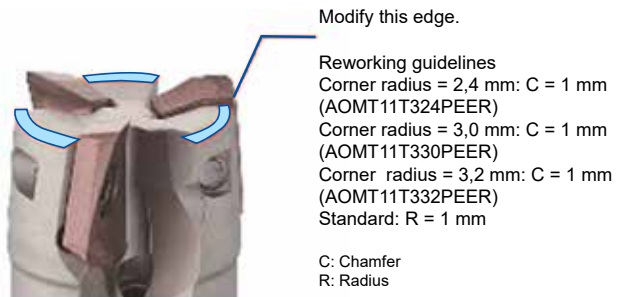

## Inserts

## Precautions for Mounting → H. 29

Application	Coated Carbide								Carbide	DLC	Cermets	RE	Fig.
	K	P	P	K	K	M	M	S					
High Speed / Light Cut													
General Purpose													
Roughing													
Cat. No.	ACU2500	XCU2500	ACP2000	ACP3000	XCK2000	ACK2000	ACK3000	ACM200	ACM300	H20	DL2000	T2500A	
AOMT 11T302PEER-G	●	○	□	●	○	□	●	●	●	-	-	●	0,2 1
11T304PEER-G	●	○	□	●	○	□	●	●	●	-	-	●	0,4 1
11T305PEER-G	●	○	□	●	○	□	●	●	●	-	-	●	0,5 1
11T308PEER-G	●	○	□	●	○	□	●	●	●	-	-	●	0,8 1
11T310PEER-G	●	○	□	●	○	□	●	●	●	-	-	□	1,0 1
11T312PEER-G	●	○	□	●	○	□	●	●	●	-	-	□	1,2 1
11T316PEER-G	●	○	□	●	○	□	●	●	●	-	-		1,6 1
11T320PEER-G	●	○	□	●	○	□	●	●	●	-	-		2,0 1
11T324PEER-G	●	○	□	●	○	□	●	●	●	-	-		2,4 1
11T330PEER-G	●	○	□	●	○	□	●	●	●	-	-		3,0 2
11T332PEER-G	●	○	□	●	○	□	●	●	●	-	-		3,2 2
AOMT 11T304PEER-H	●	○	□	●	○	□	●	●	●	-	-		0,4 1
11T308PEER-H	●	○	□	●	○	□	●	●	●	-	-		0,8 1
11T312PEER-H	●	○	□	●	○	□	●	●	●	-	-		1,2 1
11T316PEER-H	●	○	□	●	○	□	●	●	●	-	-		1,6 1
AOET 11T302PEER-F	●	-	-	-	-	-	-	-	-	-	-		0,2 1
11T304PEER-F	●	-	-	-	-	-	-	-	-	-	-		0,4 1
11T305PEER-F	●	-	-	-	-	-	-	-	-	-	-		0,5 1
11T308PEER-F	●	-	-	-	-	-	-	-	-	-	-		0,8 1
11T310PEER-F	●	-	-	-	-	-	-	-	-	-	-		1,0 1
11T312PEER-F	●	-	-	-	-	-	-	-	-	-	-		1,2 1
11T316PEER-F	●	-	-	-	-	-	-	-	-	-	-		1,6 1
11T320PEER-F	●	-	-	-	-	-	-	-	-	-	-		2,0 1
11T324PEER-F	●	-	-	-	-	-	-	-	-	-	-		2,4 1
11T330PEER-F	●	-	-	-	-	-	-	-	-	-	-		3,0 2
11T332PEER-F	●	-	-	-	-	-	-	-	-	-	-		3,2 2
AOET 11T302PEER-P16	●	-	-	-	-	-	-	-	-	-	-		0,2 1
11T304PEER-P16	●	-	-	-	-	-	-	-	-	-	-		0,4 1
11T305PEER-P16	●	-	-	-	-	-	-	-	-	-	-		0,5 1
11T308PEER-P16	●	-	-	-	-	-	-	-	-	-	-		0,8 1
11T310PEER-P16	●	-	-	-	-	-	-	-	-	-	-		1,0 1
11T312PEER-P16	●	-	-	-	-	-	-	-	-	-	-		1,2 1
11T302PEER-P20	●	-	-	-	-	-	-	-	-	-	-		0,2 1
11T304PEER-P20	●	-	-	-	-	-	-	-	-	-	-		0,4 1
11T305PEER-P20	●	-	-	-	-	-	-	-	-	-	-		0,5 1
11T308PEER-P20	●	-	-	-	-	-	-	-	-	-	-		0,8 1
11T310PEER-P20	●	-	-	-	-	-	-	-	-	-	-		1,0 1
11T312PEER-P20	●	-	-	-	-	-	-	-	-	-	-		1,2 1
11T302PEER-P25	●	-	-	-	-	-	-	-	-	-	-		0,2 1
11T304PEER-P25	●	-	-	-	-	-	-	-	-	-	-		0,4 1
11T305PEER-P25	●	-	-	-	-	-	-	-	-	-	-		0,5 1
11T308PEER-P25	●	-	-	-	-	-	-	-	-	-	-		0,8 1
11T310PEER-P25	●	-	-	-	-	-	-	-	-	-	-		1,0 1
11T312PEER-P25	●	-	-	-	-	-	-	-	-	-	-		1,2 1
AOET 11T302PEFR-S	-	-	-	-	-	-	-	-	●	●	-		0,2 1
11T304PEFR-S	-	-	-	-	-	-	-	-	●	●	-		0,4 1
11T305PEFR-S	-	-	-	-	-	-	-	-	●	●	-		0,5 1
11T308PEFR-S	-	-	-	-	-	-	-	-	●	●	-		0,8 1
11T310PEFR-S	-	-	-	-	-	-	-	-	●	●	-		1,0 1
11T312PEFR-S	-	-	-	-	-	-	-	-	●	●	-		1,2 1
11T316PEFR-S	-	-	-	-	-	-	-	-	●	●	-		1,6 1
11T320PEFR-S	-	-	-	-	-	-	-	-	●	●	-		2,0 1
11T324PEFR-S	-	-	-	-	-	-	-	-	●	●	-		2,4 1
11T330PEFR-S	-	-	-	-	-	-	-	-	●	●	-		3,0 2
11T332PEFR-S	-	-	-	-	-	-	-	-	●	●	-		3,2 2

Dimensions (mm)

Fig. 1

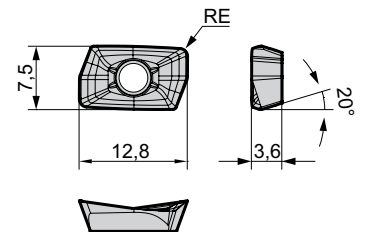
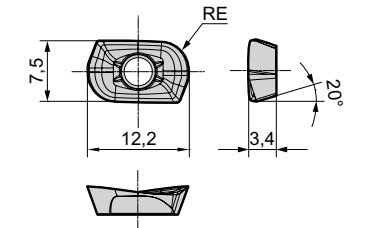

Fig. 2



L: Low cutting force  
G: General purpose  
H: Strong edge  
F: Finishing  
P: High-precision machining  
S: Non ferrous metals

\*P16 is applicable to cutter diameters Ø 14 mm and Ø 16 mm.  
\*P20 is applicable to cutter diameters Ø 18 mm, Ø 20 mm.  
\*P25 is applicable to cutter diameters Ø 25 mm, Ø 28 mm.

# "Wave Mill" Series WEZ 17000 M

## Modular Type

Rake Angle	Radial	-6° - -12°	15 mm	90°
	Axial	6° - 15°		



Fig. 1

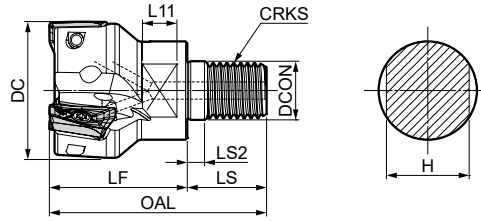

### Head

Dimensions (mm)

Cat. No.	Stock	DC	DCON	CRKS	OAL	LF	LS2	L11	H	No. of Teeth	Weight (kg)	Fig.
WEZ 17025M012Z2	●	25	12,5	M12	56	35	5	10	19	2	0,08	1
17025M012Z3	●	25	12,5	M12	56	35	5	10	19	3	0,07	1
17028M012Z2	●	28	12,5	M12	56	35	5	10	19	2	0,10	1
17030M016Z2	●	30	17	M16	63	40	5	10	24	2	0,17	1
17030M016Z3	●	30	17	M16	63	40	5	10	24	3	0,15	1
17032M016Z2	●	32	17	M16	63	40	5	10	24	2	0,19	1
17032M016Z3	●	32	17	M16	63	40	5	10	24	3	0,16	1
17032M016Z4	●	32	17	M16	63	40	5	10	24	4	0,14	1
17035M016Z2	●	35	17	M16	63	40	5	10	24	2	0,21	1
17035M016Z3	●	35	17	M16	63	40	5	10	24	3	0,19	1
17040M016Z2	●	40	17	M16	63	40	5	10	24	2	0,15	1
17040M016Z3	●	40	17	M16	63	40	5	10	24	3	0,23	1
17040M016Z4	●	40	17	M16	63	40	5	10	24	4	0,21	1

Inserts are sold separately. Arbor → H5.

### Spare Parts

Applicable Cutters	Insert Screw		Wrench
	WEZ 17025M12Z2-17030M16Z3 17032M16Z2-17040M16Z4	BFTX0407IP BFTX0409IP	3,0

### Identification Details

<b>WEZ</b>	<b>17</b>	<b>025</b>	<b>M 12</b>	<b>Z2</b>
Cutter Series	Insert Size	Cutter Diameter	Mounting Screw Size	Number of Teeth

### Recommended Cutting Conditions

→ H. 28

\*When mounting inserts with nose radius of  $\geq 2,4$  mm, modification of the body is required.

Modify this edge.

Reworking guidelines  
 Corner radius = 2,4 mm: C = 1 mm (AOMT170524PEER)  
 Corner radius = 3,0 mm: C = 1 mm (AOMT170530PEER)  
 Corner radius = 3,2 mm: C = 1 mm (AOMT170532PEER)  
 Corner radius = 4,0 mm: C = 2 mm (AOMT170540PEER)  
 Corner radius = 5,0 mm: C = 5 mm (AOMT170550PEER)  
 Corner radius = 6,4 mm: C = 5 mm (AOMT170564PEER)  
 Standard: R = 1 mm

C: Chamfer  
R: Radius

## Inserts

## Precautions for Mounting → H29

Application	Coated Carbide								Carbide	DLC	Cermets	Dimensions (mm)		
	P	K	K	M	M	S	S	S						
High Speed / Light Cut														
General Purpose														
Roughing														
Cat. No.	ACU2500	XCU2500	ACP2000	ACP3000	XCK2000	ACK2000	ACK3000	ACM200	ACM300	H20	DL2000	T2500A	RE	Fig.
AOMT 170502PEER-L	●												0,2	1
170504PEER-L	●	○											0,4	1
170508PEER-L	●	○											0,8	1
170512PEER-L	●												1,2	1
170516PEER-L	●												1,6	1
AOMT 170502PEER-G	●												0,2	1
170504PEER-G	●	○											0,4	1
170505PEER-G	●												0,5	1
170508PEER-G	●	○											0,8	1
170510PEER-G	●												1,0	1
170512PEER-G	●												1,2	1
170516PEER-G	●												1,6	1
170520PEER-G	●												2,0	1
170524PEER-G	●												2,4	1
170530PEER-G	●												3,0	1
170532PEER-G	●												3,2	1
170540PEER-G	●												4,0	1
170550PEER-G	●												5,0	2
170564PEER-G	□												6,4	2
AOMT 170504PEER-H	●	○											0,4	1
170508PEER-H	●	○											0,8	1
170512PEER-H	●												1,2	1
170516PEER-H	●												1,6	1
AOET 170502PEER-F	●												0,2	1
170504PEER-F	●												0,4	1
170505PEER-F	●												0,5	1
170508PEER-F	●												0,8	1
170510PEER-F	●												1,0	1
170512PEER-F	●												1,2	1
170516PEER-F	●												1,6	1
170520PEER-F	●												2,0	1
170524PEER-F	●												2,4	1
170530PEER-F	●												3,0	1
170532PEER-F	●												3,2	1
170540PEER-F	●												4,0	1
170550PEER-F	●												5,0	2
170564PEER-F	●												6,4	2
AOET 170502PEER-P25	●												0,2	1
170504PEER-P25	●												0,4	1
170505PEER-P25	●												0,5	1
170508PEER-P25	●												0,8	1
170510PEER-P25	●												1,0	1
170512PEER-P25	●												1,2	1
170502PEER-P32	●												0,2	1
170504PEER-P32	●												0,4	1
170505PEER-P32	●												0,5	1
170508PEER-P32	●												0,8	1
170510PEER-P32	●												1,0	1
170512PEER-P32	●												1,2	1
AOET 170502PEFR-S	-	-	-	-	-	-	-	-	●	●	-	-	0,2	1
170504PEFR-S	-	-	-	-	-	-	-	-	●	●	-	-	0,4	1
170505PEFR-S	-	-	-	-	-	-	-	-	●	●	-	-	0,5	1
170508PEFR-S	-	-	-	-	-	-	-	-	●	●	-	-	0,8	1
170510PEFR-S	-	-	-	-	-	-	-	-	●	●	-	-	1,0	1
170512PEFR-S	-	-	-	-	-	-	-	-	●	●	-	-	1,2	1
170516PEFR-S	-	-	-	-	-	-	-	-	●	●	-	-	1,6	1
170520PEFR-S	-	-	-	-	-	-	-	-	●	●	-	-	2,0	1
170524PEFR-S	-	-	-	-	-	-	-	-	●	●	-	-	2,4	1
170530PEFR-S	-	-	-	-	-	-	-	-	●	●	-	-	3,0	1
170532PEFR-S	-	-	-	-	-	-	-	-	●	●	-	-	3,2	1
170540PEFR-S	-	-	-	-	-	-	-	-	●	●	-	-	4,0	1
170550PEFR-S	-	-	-	-	-	-	-	-	●	●	-	-	5,0	2
170564PEFR-S	-	-	-	-	-	-	-	-	●	●	-	-	6,4	2

Dimensions (mm)

Fig. 1

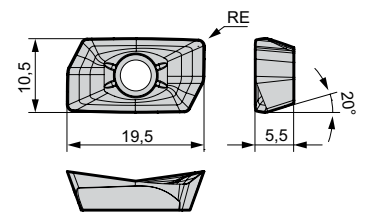
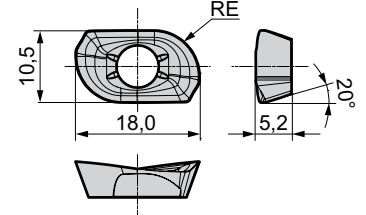

Fig. 2



L: Low cutting force  
 G: General purpose  
 H: Strong edge  
 F: Finishing  
 P: High-precision machining  
 S: Non ferrous metals

\*P25 is applicable to cutter diameters Ø 25 mm and Ø 28 mm.  
 \*P32 is applicable to cutter diameters Ø 30 mm, Ø 32 mm and Ø 35 mm.

# "Wave Mill" Series WEZR 11000 M

**New**

Repeater, Modular Type

Rake Angle	Radial	-12°	27 mm	90°
	Axial	11°		



Fig. 1

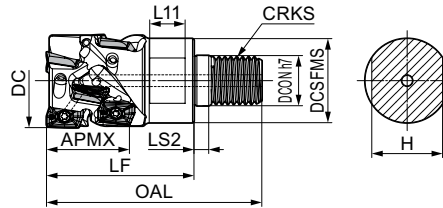

## Head

Dimensions (mm)

Cat. No.	Stock	DC	APMX	DCSFMS	DCON	CRKS	OAL	LF	LS2	L11	H	Total No. of Teeth	Steps	Effective No. of Teeth	Weight (kg)	Fig.
WEZR 11032M1627Z3	○	32	27	28,5	17	M16	73	50	5	12	24	9	3	3	0,21	1

Inserts are sold separately. Arbor → H5.

## Spare Parts

Applicable Cutters	Insert Screw		Wrench
WEZR 11_ _ _	BFTX0306IP	1,5	TRDR08IP

## Recommended Cutting Conditions

ISO	Work Material	Hardness (HB)	Chipbreaker	Cutting Speed $v_c$ (m/min)	Feed Rate $f_z$ (mm/t)	Grades
P	Carbon Steel	≤ 280HB	G	100-150-200	0,08-0,12-0,20	ACU2500 XCU2500
		> 280HB	G	80-100-120	0,08-0,12-0,20	ACP2000 ACP3000
	Alloy Steel	≤ 280HB	G	100-150-80	0,08-0,12-0,20	ACU2500 ACM200 ACM300
M	Stainless Steel	≤ 280HB	G	80-120-160	0,08-0,12-0,20	ACU2500 XCK2000 ACK2000 ACK3000
K	Cast Iron Ductile Cast Iron	-	G	100-150-200	0,08-0,12-0,20	ACU2500 ACM200 ACM300
S	Exotic Alloy	-	G	40-50-60	0,08-0,12-0,20	DL2000 H20
N	Aluminum Alloy	Si ≤ 12,6%	S	300-500-800	0,05-0,10-0,15	
		Si > 12,6%	S	100-200-250	0,05-0,10-0,15	

Min. - Optimum - Max.

Note:

The cutting conditions above are a guide. Actual conditions will need to be adjusted according to machine rigidity, work clamp rigidity, depth of cut and other factors. There may be cases where machining cannot be performed under recommended cutting conditions, depending on the machine rigidity and work rigidity.

## Identification Details

**WEZR 11 032 M16 27 Z3**

Cutter Series	Insert Size	Cutter Diameter	Mounting Screw Size	Max. Depth of Cut	Effective Number of Teeth
WEZR 11	032	M16	27	Z3	

\*When mounting inserts with nose radius of  $\geq 2,4$  mm, modification of the body is required.



Modify this edge.

Reworking guidelines  
 Corner radius = 2,4 mm: C = 1 mm (AOMT11T324PEER)  
 Corner radius = 3,0 mm: C = 1 mm (AOMT11T330PEER)  
 Corner radius = 3,2 mm: C = 1 mm (AOMT11T332PEER)  
 Standard: R = 1 mm

C: Chamfer  
 R: Radius

# "Wave Mill" Series WEZR 11000 M

## ■ Inserts

Precautions for Mounting → H29

Application	Coated Carbide										Carbide	DLC	Cermets	Dimensions (mm)		
	ACU2500	XCU2500	ACP2000	ACP3000	XCK2000	ACK2000	ACK3000	ACM200	ACM300	H20						DL2000
High Speed / Light Cut																
General Purpose																
Roughing																
Cat. No.	ACU2500	XCU2500	ACP2000	ACP3000	XCK2000	ACK2000	ACK3000	ACM200	ACM300	H20	DL2000	T2500A	RE	Fig.		
AOMT 11T302PEER-G	●		□	●		□	●	●	●	-	-	●	0,2	1		
11T304PEER-G	●	○	●	□	○	□	●	●	●	-	-	●	0,4	1		
11T305PEER-G	●		□	□		□	□	□	□	-	-	□	0,5	1		
11T308PEER-G	●	○	●	●	○	●	●	●	●	-	-	●	0,8	1		
11T310PEER-G	●		□	□		□	□	□	□	-	-	□	1,0	1		
11T312PEER-G	●		□	●		□	●	●	●	-	-	□	1,2	1		
11T316PEER-G	●		□	●		□	●	●	●	-	-		1,6	1		
11T320PEER-G	●		□	●		□	●	●	●	-	-		2,0	1		
11T324PEER-G	●		□	□		□	□	□	□	-	-		2,4	1		
11T330PEER-G	●		□	●		□	●	●	●	-	-		3,0	2		
11T332PEER-G	●		□	□		□	□	□	□	-	-		3,2	2		
AOMT 11T304PEER-H	●	○	●	●	○	●	●	●	●	-	-	-	0,4	1		
11T308PEER-H	●	○	●	●	○	●	●	●	●	-	-	-	0,8	1		
11T312PEER-H	●		□	□		□	□	□	□	-	-	-	1,2	1		
11T316PEER-H	●		□	□		□	□	□	□	-	-	-	1,6	1		
AOET 11T302PEER-F	●		-							-	-	-	0,2	1		
11T304PEER-F	●		-							-	-	-	0,4	1		
11T305PEER-F	●		-							-	-	-	0,5	1		
11T308PEER-F	●		-							-	-	-	0,8	1		
11T310PEER-F	●		-							-	-	-	1,0	1		
11T312PEER-F	●		-							-	-	-	1,2	1		
11T316PEER-F	●		-							-	-	-	1,6	1		
11T320PEER-F	●		-							-	-	-	2,0	1		
11T324PEER-F	●		-							-	-	-	2,4	1		
11T330PEER-F	●		-							-	-	-	3,0	2		
11T332PEER-F	●		-							-	-	-	3,2	2		
AOET 11T302PEFR-S	-	-	-	-	-	-	-	-	-	●	●	-	0,2	1		
11T304PEFR-S	-	-	-	-	-	-	-	-	-	●	●	-	0,4	1		
11T305PEFR-S	-	-	-	-	-	-	-	-	-	●	●	-	0,5	1		
11T308PEFR-S	-	-	-	-	-	-	-	-	-	●	●	-	0,8	1		
11T310PEFR-S	-	-	-	-	-	-	-	-	-	●	●	-	1,0	1		
11T312PEFR-S	-	-	-	-	-	-	-	-	-	●	●	-	1,2	1		
11T316PEFR-S	-	-	-	-	-	-	-	-	-	●	●	-	1,6	1		
11T320PEFR-S	-	-	-	-	-	-	-	-	-	●	●	-	2,0	1		
11T324PEFR-S	-	-	-	-	-	-	-	-	-	●	●	-	2,4	1		
11T330PEFR-S	-	-	-	-	-	-	-	-	-	●	●	-	3,0	2		
11T332PEFR-S	-	-	-	-	-	-	-	-	-	●	●	-	3,2	2		

Dimensions (mm)

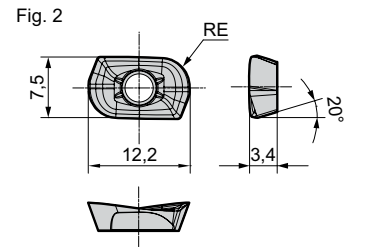
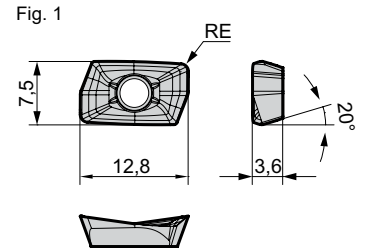

L: Low cutting force  
 G: General purpose  
 H: Strong edge  
 F: Finishing  
 P: High-precision machining  
 S: Non ferrous metals

Use peripheral inserts with RE ≤ 0,8 mm from the second step and above.

Indexable  
Endmills



# "Wave Mill" Series WEZR 17000 M



Repeater, Modular Type

Rake Angle	Radial	-9°	29 mm	90°
	Axial	10°		



Fig. 1

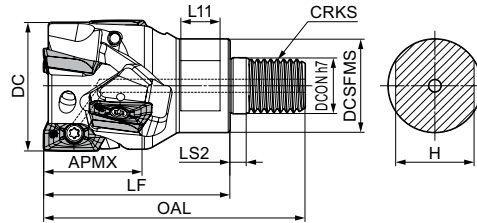

## Head

Dimensions (mm)

Cat. No.	Stock	DC	APMX	DCSFMS	DCON	CRKS	OAL	LF	LS2	L11	H	Total No. of Teeth	Steps	Effective No. of Teeth	Weight (kg)	Fig.
WEZR 17040M1629Z3	○	40	29	28,5	17	M16	80	57	5	12	24	6	2	3	0,29	1

Inserts are sold separately. Arbor → H5.

## Spare Parts

Applicable Cutters	Insert Screw		Wrench
WEZR 17_ _ _	BFTX0409IP	1,5	TRDR15IP

## Recommended Cutting Conditions

ISO	Work Material	Hardness (HB)	Chipbreaker	Cutting Speed $v_c$ (m/min)	Feed Rate $f_z$ (mm/t)	Grades
P	Carbon Steel	≤ 280HB	G	100-150-200	0,10-0,20-0,30	ACU2500 XCU2500
		> 280HB	G	80-100-120	0,10-0,20-0,30	ACP2000 ACP3000
	Alloy Steel	≤ 280HB	G	100-150-80	0,10-0,20-0,30	
M	Stainless Steel	≤ 280HB	G	80-120-160	0,10-0,20-0,30	ACU2500 ACM200 ACM300
K	Cast Iron Ductile Cast Iron	-	G	100-150-200	0,10-0,20-0,30	ACU2500 XCK2000 ACK2000 ACK3000
S	Exotic Alloy	-	G	40-50-60	0,10-0,20-0,30	ACU2500 ACM200 ACM300
N	Aluminum Alloy	Si ≤ 12,6%	S	300-500-800	0,05-0,10-0,15	DL2000
		Si > 12,6%	S	100-200-250	0,05-0,10-0,15	H20

Min. - Optimum - Max.

Note:

The cutting conditions above are a guide. Actual conditions will need to be adjusted according to machine rigidity, work clamp rigidity, depth of cut and other factors.

There may be cases where machining cannot be performed under recommended cutting conditions, depending on the machine rigidity and work rigidity.

## Identification Details

**WEZR 17 040 M16 29 Z3**

Cutter Series	Insert Size	Cutter Diameter	Mounting Screw Size	Max. Depth of Cut	Effective Number of Teeth
---------------	-------------	-----------------	---------------------	-------------------	---------------------------

\*When mounting inserts with nose radius of  $\geq 2,4$  mm, modification of the body is required.



Modify this edge.

Reworking guidelines

Corner radius = 2,4 mm: C = 1 mm (AOMT170524PEER)

Corner radius = 3,0 mm: C = 1 mm (AOMT170530PEER)

Corner radius = 3,2 mm: C = 1 mm (AOMT170532PEER)

Corner radius = 4,0 mm: C = 2 mm (AOMT170540PEER)

Corner radius = 5,0 mm: C = 5 mm (AOMT170550PEER)

Corner radius = 6,4 mm: C = 5 mm (AOMT170564PEER)

Standard: R = 1 mm

C: Chamfer  
R: Radius

# "Wave Mill" Series WEZR 17000 M

## ■ Inserts

## Precautions for Mounting

→ H29

Application	Coated Carbide										Carbide	DLC	Cermets	Dimensions (mm)		
	KM	P	P	K	K	MS	MS	N	N	P						
High Speed / Light Cut																
General Purpose																
Roughing																
Cat. No.	ACU2500	XCU2500	ACP2000	ACP3000	XCK2000	ACK2000	ACK3000	ACM200	ACM300	H20	DL2000	T2500A	RE	Fig.		
AOMT 170502PEER-L	●			□			□	●	●			□	0,2	1		
170504PEER-L	●	○			○			●	●			□	0,4	1		
170508PEER-L	●	○			○			●	●			□	0,8	1		
170512PEER-L	●			□			□	●	●			□	1,2	1		
170516PEER-L	●			□			□	●	●			□	1,6	1		
AOMT 170502PEER-G	●		□	●		□	●	●	●			□	0,2	1		
170504PEER-G	●	○	●	□	○	●	●	●	●			□	0,4	1		
170505PEER-G	●		□	□		□	●	●	●			□	0,5	1		
170508PEER-G	●	○	●	□	○	●	●	●	●			□	0,8	1		
170510PEER-G	●		□	□		□	●	●	●			□	1,0	1		
170512PEER-G	●		□	□		□	●	●	●			□	1,2	1		
170516PEER-G	●		□	□		□	●	●	●			□	1,6	1		
170520PEER-G	●		□	□		□	●	●	●			□	2,0	1		
170524PEER-G	●		□	□		□	●	●	●			□	2,4	1		
170530PEER-G	●		□	□		□	●	●	●			□	3,0	1		
170532PEER-G	●		□	□		□	●	●	●			□	3,2	1		
170540PEER-G	●		□	□		□	●	●	●			□	4,0	1		
170550PEER-G	●		□	□		□	●	●	●			□	5,0	2		
170564PEER-G	□		□	□		□	●	●	●			□	6,4	2		
AOMT 170504PEER-H	●	○	●	●	○	●	●	●	●			□	0,4	1		
170508PEER-H	●	○	●	●	○	●	●	●	●			□	0,8	1		
170512PEER-H	●		□	□		□	●	●	●			□	1,2	1		
170516PEER-H	●		□	●		□	●	●	●			□	1,6	1		
AOET 170502PEER-F	●											□	0,2	1		
170504PEER-F	●											□	0,4	1		
170505PEER-F	●											□	0,5	1		
170508PEER-F	●											□	0,8	1		
170510PEER-F	●											□	1,0	1		
170512PEER-F	●											□	1,2	1		
170516PEER-F	●											□	1,6	1		
170520PEER-F	●											□	2,0	1		
170524PEER-F	●											□	2,4	1		
170530PEER-F	●											□	3,0	1		
170532PEER-F	●											□	3,2	1		
170540PEER-F	●											□	4,0	1		
170550PEER-F	●											□	5,0	2		
170564PEER-F	●											□	6,4	2		
AOET 170502PEFR-S	-	-	-	-	-	-	-	-	-	●	●	-	0,2	1		
170504PEFR-S	-	-	-	-	-	-	-	-	-	●	●	-	0,4	1		
170505PEFR-S	-	-	-	-	-	-	-	-	-	●	●	-	0,5	1		
170508PEFR-S	-	-	-	-	-	-	-	-	-	●	●	-	0,8	1		
170510PEFR-S	-	-	-	-	-	-	-	-	-	●	●	-	1,0	1		
170512PEFR-S	-	-	-	-	-	-	-	-	-	●	●	-	1,2	1		
170516PEFR-S	-	-	-	-	-	-	-	-	-	●	●	-	1,6	1		
170520PEFR-S	-	-	-	-	-	-	-	-	-	●	●	-	2,0	1		
170524PEFR-S	-	-	-	-	-	-	-	-	-	●	●	-	2,4	1		
170530PEFR-S	-	-	-	-	-	-	-	-	-	●	●	-	3,0	1		
170532PEFR-S	-	-	-	-	-	-	-	-	-	●	●	-	3,2	1		
170540PEFR-S	-	-	-	-	-	-	-	-	-	●	●	-	4,0	1		
170550PEFR-S	-	-	-	-	-	-	-	-	-	●	●	-	5,0	2		
170564PEFR-S	-	-	-	-	-	-	-	-	-	●	●	-	6,4	2		

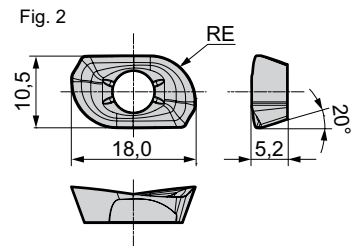
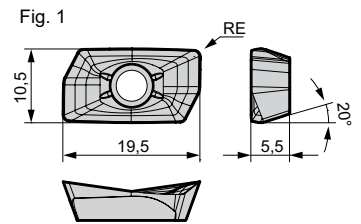

- L: Low cutting force
- G: General purpose
- H: Strong edge
- F: Finishing
- P: High-precision machining
- S: Non ferrous metals

Use peripheral inserts with RE ≤ 0,8 mm from the second step and above.

# "Wave Mill" Series WEX Type

For the Smooth and Reliable Cutting Action



## General Features

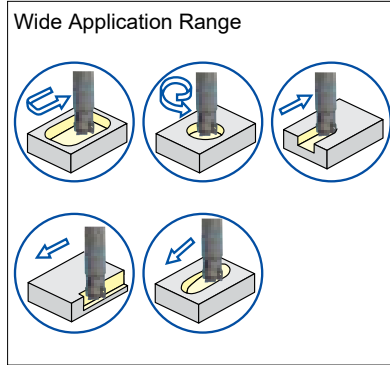

## Ramping (Slant Milling)

Tool Diam. Ø D	Max. Ramping Angle		
	Type 1000	Type 2000	Type 3000
10	2°30'		
12	1°45'		
14	1°25'	1°40'	
16	1°00'	1°20'	
18	0°45'	1°10'	
20	0°30'	1°00'	
25	0°30'	0°45'	1°30'
32	0°25'	0°35'	1°00'
40	0°20'	0°25'	0°45'
50	0°15'	0°20'	0°30'
63	0°10'	0°15'	0°20'
80			0°15'
100			-

Maximum ramping angle ( $\alpha$  max. max.) depends on cutter diameter.

### Precision insert with strong cutting edge and low cutting force

Wave shaped cutting edge design lowers cutting resistance yet improves cutting edge strength.

Achieving high quality finish with high precision cutting edge.

Smooth cutting even for deep grooves and low rigidity machines.

High precision curved cutting edge

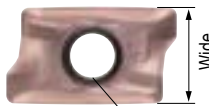

Screw hole size increased

High rake wave cutting edge

Large angle

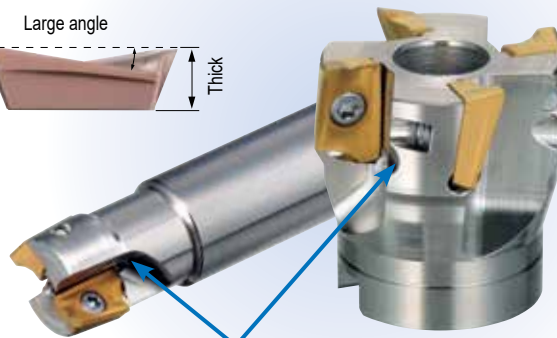
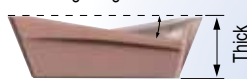

● Internal Coolant Holes  
Improved chip evacuation with air or coolant supply.

### Wide Variety of Inserts

6 types of chipbreaker design (L, G, H, E, EH and S)

9 milling grades for a wide range of work materials and applications.

- ACP100, ACP200, ACP300 (steel milling grades)

- ACK200, ACK300

(cast iron milling grades)

- ACM200, ACM300

(stainless steel, exotic alloy milling grades)

- DL1000, H1

(aluminium milling grades)

### High Durable Body

Special surface treatment improves corrosion resistance as well as scratch resistance.

Increased screw size improves clamping force and durability.

## Product Range

Type	Cat. No.	Series	Diameter Range (mm)				Image
			Ø 10	Ø 20	Ø 40	Ø 60	
Shank	WEX 1000E	Short Type	10	25			 WEX3000    WEX2000    WEX1000
	WEX 1000EL	Long Type	10	20			
	WEX 2000E	Short Type	14		63		
	WEX 2000EL	Long Type	14		40		
	WEX 2000EW	Weldon Shank Short Type	16	20			
	WEX 3000E	Short Type	25		63		
	WEX 3000EL	Long Type	25		40		
WEX 3000EW	Weldon Shank Short Type	25	32				
Shell	WEX 1000F	Shell Type		32		63	 → G58
	WEX 2000F	Shell Type		40		63	
	WEX 3000F	Shell Type		40		63	
Modular	WEX 2000M	Modular Type	16		40		
	WEX 3000M	Modular Type	25		40		

## ■ WEX1000 Type Expansion

- Efficient machining via high number of inserts
- Precise insert change tolerance provides high surface roughness quality
- High shoulder accuracy due to optimized cutting edge
- Stable cutting conditions when utilising low rigidity machines
- Economic advantages using small AXMT06 inserts

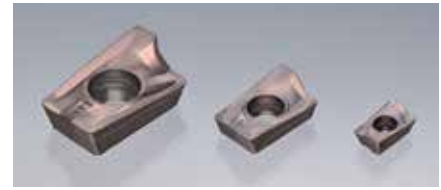

WEX3000      WEX2000      WEX1000

## ■ Application Range

Shoulder Milling

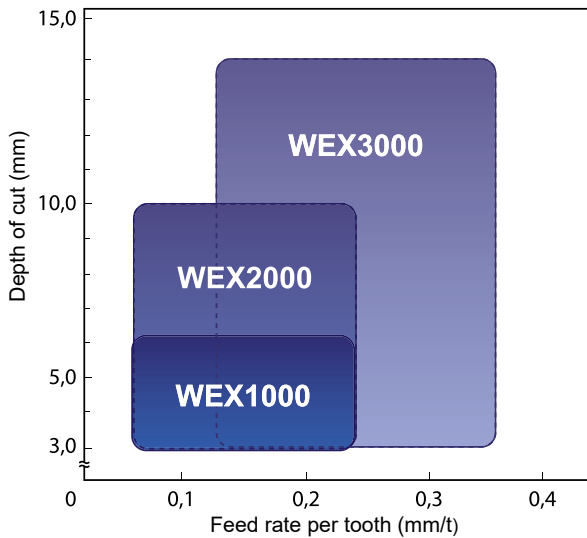

## ■ Chipbreaker Selection

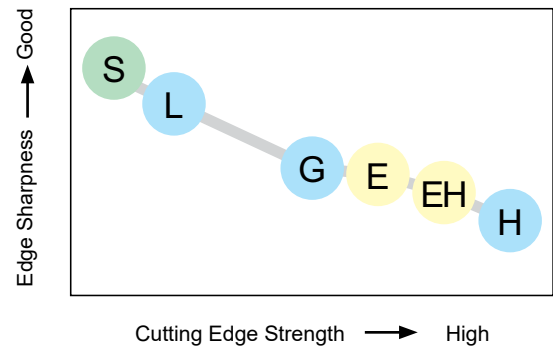

## ● Characteristics

Work Material	Steel, Cast Iron			Stainless Steel, Exotic Alloy		Aluminium
	L	G	H	E	EH	S
Chipbreaker						
Features	Low Cutting Force	General Purpose	Strong Edged	General Purpose	Strong Edged	High Rake
Chipbreaker Profile for 1000 Series Insert						
Chipbreaker Profile for 2000 Series Insert						
Chipbreaker Profile for 3000 Series Insert						
Application	Light cut, low rigidity milling and reduced burrs	<b>Main chipbreaker</b> general purpose to interrupted milling	Roughing, heavy interrupted and hardened steel milling	Light cutting to general purpose	Heavy interrupted machining	Aluminium, non-ferrous metal

## ■ Grade Selection

ISO	Grade	Finishing to Light Cutting	Medium Cut	Rough to Heavy Cutting
P	Coated Carbide	ACP100	ACP200	ACP300
		ACM200	ACM300	

ISO	Grade	Finishing to Light Cutting	Medium Cut	Rough to Heavy Cutting
K	Coated Carbide	ACK200	ACK300	
N	Coated Carbide	DL1000		
	Carbide		H1	

# "Wave Mill" Series WEX 1000 E/L

## WEX 1000 E/EL

### Shank Type

Rake Angle	Radial	8°-15°
	Axial	16°-24°

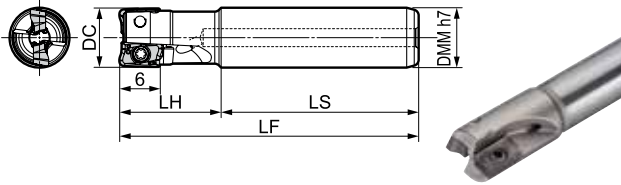

### Body (Short Type „E“)

Cat. No.	Stock	Dimensions (mm)					No. of Teeth	Weight (kg)
		DC	DMM	LH	LS	LF		
WEX 1010 E	▲	10	10	17	33	50	2	0,03
1012 E	▲	12	12	20	60	80	3	0,06
1014 E	▲	14	16	22	59	80	3	0,10
1016 E	▲	16	16	20	72	90	4	0,12
1018 E	▲	18	20	20	80	100	4	0,21
WEX 1020 E	▲	20	20	22	78	100	5	0,22
1025 E	▲	25	20	25	90	115	7	0,27

### Body (Long Type „EL“)

Cat. No.	Stock	Dimensions (mm)					No. of Teeth	Weight (kg)
		DC	DMM	LH	LS	LF		
WEX 1010 EL	▲	10	8	17	83	100	2	0,03
1012 EL	▲	12	10	20	100	120	2	0,06
1014 EL	▲	14	12	20	125	145	3	0,11
1016 EL	▲	16	14	20	140	160	3	0,17
1016 EL15	▲	16	15	20	140	160	3	0,19
1018 EL	▲	18	16	20	160	180	3	0,25
WEX 1020 EL	▲	20	18	25	175	200	4	0,36
1020 EL19	▲	20	19	25	175	200	4	0,38

Inserts are not included.

### Inserts for WEX1000 Type

Application	Coated Carbide							Carbide	DLC
	P	M	M	K	K	M	S		
High Speed / Light cut	■			■		■	■	■	■
General Purpose		■	■	■		■	■		■
Roughing		■	■		■		■		
Cat. No.	ACP100	ACP200	ACP300	ACK200	ACK300	ACM200	ACM300	H1	DL1000
AXMT 060204 PDER-L	▲	▲	▲	▲	▲	▲	▲	-	-
060208 PDER-L	▲	▲	▲	▲	▲	▲	▲	-	-
060212 PDER-L	▲	▲			○	▲	▲	-	-
AXMT 060204 PDER-G	▲	▲	▲	○	▲	▲	▲	-	-
060208 PDER-G	▲	▲	▲	▲	▲	▲	▲	-	-
060212 PDER-G	○	▲	▲		▲	▲	▲	-	-
AXMT 060204 PDER-H	○	▲	▲		▲	▲	▲	-	-
060208 PDER-H		▲	▲		▲	▲	▲	-	-
060212 PDER-H	○	▲	▲		▲	▲	▲	-	-
AXMT 060202 PDFR-S	-	-	-	-	-	-	-	○	○

L - Low cutting force  
G - General type  
H - Strong cutting edge  
S - For aluminium alloy

### Identification Details

**WEX 1 016 EL 15**

Cutter Series 1000 Series    Cutter Diameter 016    Shank Type EL    Shank Diameter 15

### Spare Parts

Screw	Wrench	Applicable Endmill
0,5 Nm BFTX 01804 IP	TRX 06 IP	

○ = Japan stock

□ = Delivery on request  
▲ = To be replaced by new item

Recommended Tightening Torque (N·m)

# "Wave Mill" Series WEX 2000 E/EL

## WEX 2000 E/EL

### Shank Type

Rake Angle	Radial	8°-15°	10 mm	90°
	Axial	16°-24°		

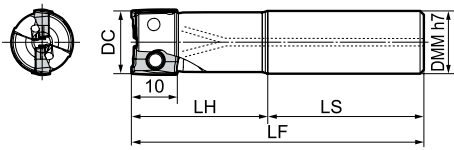

### Body (Short Type „E“)

Cat. No.	Stock	Dimensions (mm)					No. of Teeth	Weight (kg)
		DC	DMM	LH	LS	LF		
WEX 2014 E	▲	14	16	25	55	80	1	0,10
2016 E	▲	16	16	25	75	100	2	0,13
2018 E	▲	18	16	25	75	100	2	0,14
WEX 2020 E	▲	20	20	30	80	110	3	0,22
2022 E	▲	22	20	30	80	110	3	0,23
WEX 2025 E	▲	25	25	35	85	120	4	0,38
2028 E	○	28	25	35	85	120	4	0,39
2030 E	▲	30	25	35	85	120	4	0,40
WEX 2032 E	▲	32	32	40	90	130	5	0,70
2040 E	○	40	32	30	120	150	6	0,91
WEX 2050 E	○	50	32	30	120	150	7	1,02
2063 E	○	63	32	30	120	150	8	1,22

### Body (Long Type „EL“)

Cat. No.	Stock	Dimensions (mm)					No. of Teeth	Weight (kg)
		DC	DMM	LH	LS	LF		
WEX 2014 EL	▲	14	16	25	95	120	1	0,14
2016 EL	▲	16	16	25	120	145	2	0,19
2018 EL	○	18	16	25	120	145	2	0,19
WEX 2020 EL	▲	20	20	40	110	150	2	0,32
2022 EL	○	22	20	30	120	150	2	0,33
WEX 2025 EL	▲	25	25	50	120	170	2	0,55
2028 EL	○	28	25	30	140	170	2	0,59
2030 EL	○	30	25	30	140	170	2	0,60
WEX 2032 EL	○	32	32	60	120	180	2	0,99
2040 EL	○	40	32	30	150	180	2	1,12

### Body (Long Type „E“ + Small Shank)

Cat. No.	Stock	Dimensions (mm)					No. of Teeth	Weight (kg)
		DC	DMM	LH	LS	LF		
WEX 2016 EL15	▲	16	15	25	120	145	2	0,17
2020 EL19	▲	20	19	40	110	150	2	0,30
2025 EL24	▲	25	24	50	120	170	2	0,53
2025 EL24Z3	▲	25	24	50	120	170	3	0,50
2032 EL30Z4	▲	32	30	60	120	180	2	0,95

### Body (Weldon Shank Short Type „EW“)

Cat. No.	Stock	Dimensions (mm)					No. of Teeth	Weight (kg)
		DC	DMM	LH	LS	LF		
WEX 2016 EW	▲	16	16	25	75	100	2	0,12
2020 EW	▲	20	20	30	80	110	3	0,21

Inserts are not included.

### Identification Details

<b>WEX</b>	<b>2</b>	<b>016</b>	<b>EL</b>	<b>15</b>
Cutter Series	2000 Series	Cutter Diameter	Shank Type	Shank Diameter

### Spare Parts

Screw	Wrench	Applicable Endmill
2,0 N <sub>m</sub>		
BFTX 0305 IP BFTX 0306 IP	TRDR 08 IP	WEX 2014 – WEX 2018 WEX 2020 – WEX 2063

# "Wave Mill" Series WEX 2000 M

## WEX 2000 M

### Modular Type

Rake Angle	Radial	10°-18°	10 mm	90°
	Axial	14°-25°		

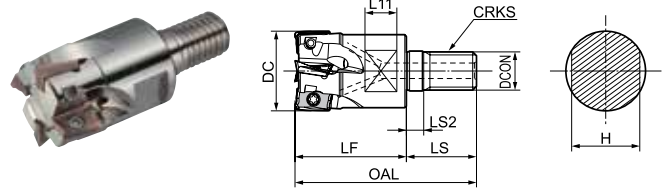

### Head

Cat. No.	Stock	Dimensions (mm)									No. of Teeth
		DC	DCON	CRKS	OAL	LF	LS2	LS	L11	H	
WEX 2016M08Z2	▲	16	8,5	M8	42	25	5	17	8	13	2
2018M08Z2	○	18	8,5	M8	42	25	5	17	8	13	2
WEX 2020M10Z3	▲	20	10,5	M10	49	30	5	19	8	15	3
2022M10Z3	○	22	10,5	M10	49	30	5	19	8	15	3
WEX 2025M12Z4	▲	25	12,5	M12	56	35	5	21	10	19	4
2028M12Z4	○	28	12,5	M12	56	35	5	21	10	19	4
WEX 2030M16Z4	○	30	17,0	M16	63	40	5	23	10	24	4
2032M16Z5	▲	32	17,0	M16	63	40	5	23	10	24	5
2040M16Z6	○	40	17,0	M16	63	40	5	23	10	24	6

Inserts are not included.

### Inserts for WEX2000 Type

Application	Coated Carbide						Carbide	DLC
	P	M	K	M/S	M/S	N		
High Speed / Light cut	▲	▲	▲	▲	▲	▲	▲	▲
General Purpose	▲	▲	▲	▲	▲	▲	▲	▲
Roughing	▲	▲	▲	▲	▲	▲	▲	▲
Cat. No.	ACP100	ACP200	ACP300	ACK200	ACK300	ACM200	ACM300	Radius
AXMT 123504 PEER-G	▲	▲	▲	▲	▲	▲	▲	0,4
123508 PEER-G	▲	▲	▲	▲	▲	▲	▲	0,8
123512 PEER-G	▲	▲	▲	▲	▲	▲	▲	1,2
AXMT 123504 PEER-H	▲	▲	▲	▲	▲	▲	▲	0,4
123508 PEER-H	▲	▲	▲	▲	▲	▲	▲	0,8
123512 PEER-H	▲	▲	▲	▲	▲	▲	▲	1,2
AXMT 123504 PEER-E	▲	▲	▲	▲	▲	▲	▲	0,4
123508 PEER-E	▲	▲	▲	▲	▲	▲	▲	0,8
123512 PEER-E	▲	▲	▲	▲	▲	▲	▲	1,2
AXMT 123508 PEER-EH	▲	▲	▲	▲	▲	▲	▲	0,8
AXET 123502 PEFR-S	–	–	–	–	–	–	▲	0,2
123504 PEFR-S	–	–	–	–	–	–	▲	0,4
123508 PEFR-S	–	–	–	–	–	–	▲	0,8

G - General type  
H - Strong cutting edge  
E - For stainless steel / exotic alloy  
EH - Strong edge for stainless steel / exotic alloy  
S - For aluminium alloy  
– - Unable to produce

### Identification Details

<b>WEX</b>	<b>2</b>	<b>016</b>	<b>M08</b>	<b>Z2</b>
Cutter Series	2000 Series	Cutter Diameter	Mounting Screw Size	No. of Teeth



### Spare Parts

Screw	Wrench	N·m	Applicable Endmill
BFTX 0305 IP BFTX 0306 IP	TRDR 08 IP	<b>2,0</b>	WEX 2016M, WEX 2018M WEX 2020M – WEX 2040M
BFTX 0407 IP BFTX 0409 IP	TRDR 15 IP	<b>3,0</b>	WEX 3025M – WEX 3030M WEX 3032M – WEX 3040M



# "Wave Mill" Series WEX 3000 E/EL

# "Wave Mill" Series WEX 3000 M

## WEX 3000 E/EL

### Shank Type

Rake Angle	Radial	8°-15°	14 mm	90°
	Axial	16°-24°		

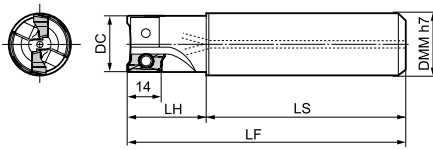

### Body (Short Type „E“)

Cat. No.	Stock	Dimensions (mm)					No. of Teeth	Weight (kg)
		DC	DMM	LH	LS	LF		
WEX 3025 E	▲	25	25	35	85	120	2	0,37
3028 E	○	28	25	35	85	120	2	0,39
3030 E	○	30	25	40	90	130	3	0,42
WEX 3032 E	▲	32	32	40	90	130	3	0,67
3035 E	▲	35	32	40	90	130	3	0,69
3040 E	▲	40	32	50	120	170	4	1,01
3050 E	○	50	32	50	120	170	5	1,23
3063 E	○	63	32	50	120	170	6	1,58

### Body (Short Type „E“ + Small Shank)

Cat. No.	Stock	Dimensions (mm)					No. of Teeth	Weight (kg)
		DC	DMM	LH	LS	LF		
WEX 3025 E20	○	25	20	35	85	120	2	0,25
3032 E25	○	32	25	40	90	130	3	0,43

### Body (Long Type „EL“)

Cat. No.	Stock	Dimensions (mm)					No. of Teeth	Weight (kg)
		DC	DMM	LH	LS	LF		
WEX 3025 EL	▲	25	25	50	120	170	2	0,54
3028 EL	○	28	25	50	120	170	2	0,56
3030 EL	○	30	25	60	120	180	2	0,60
WEX 3032 EL	▲	32	32	60	120	180	2	0,95
3035 EL	▲	35	32	60	120	180	2	0,98
3040 EL	▲	40	32	80	140	220	2	1,38

### Body (Weld on Shank Short Type „EW“)

Cat. No.	Stock	Dimensions (mm)					No. of Teeth	Weight (kg)
		DC	DMM	LH	LS	LF		
WEX 3025 EW	▲	25	25	35	85	120	2	0,36
3032 EW	▲	32	32	40	90	130	3	0,65

Inserts are not included.

\* **ATTENTION:** If nose radius of inserts is 2,0 mm or more please modify cutter body as indicated.

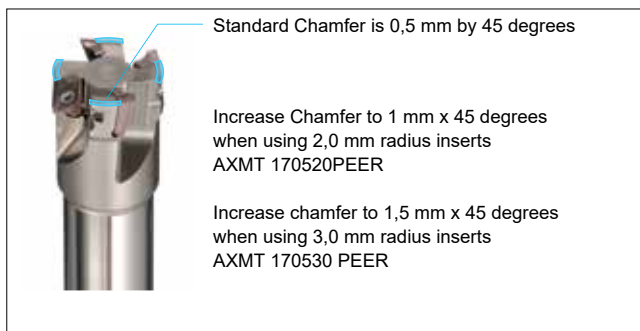

### Spare Parts

Screw	Wrench	Applicable Endmill
3,0 (Nm)		
BFTX 0407 IP BFTX 0409 IP	TRDR 15 IP	WEX 3025 - WEX 3030 WEX 3032 - WEX 3063

## WEX 3000 M

### Modular Type

Rake Angle	Radial	8°-15°	14 mm	90°
	Axial	16°-24°		

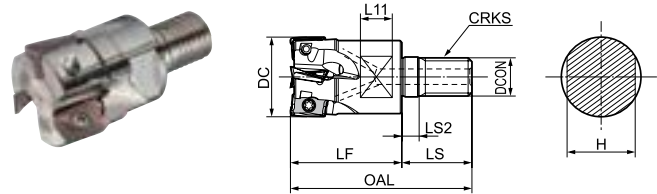

### Head

Cat. No.	Stock	Dimensions (mm)									No. of Teeth
		DC	DCON	CRKS	OAL	LF	LS2	LS	L11	H	
WEX 3025M12Z2	▲	25	12,5	M12	56	35	5	21	10	19	2
3028M12Z2	○	28	12,5	M12	56	35	5	21	10	19	2
WEX 3030M16Z3	○	30	17,0	M16	63	40	5	23	10	24	3
3032M16Z3	▲	32	17,0	M16	63	40	5	23	10	24	3
3035M16Z3	○	35	17,0	M16	63	40	5	23	10	24	3
3040M16Z4	○	40	17,0	M16	63	40	5	23	10	24	4

Inserts are not included.

### Inserts for WEX3000 Type

Application	Coated Carbide						Carbide		DLC	
	P	M	K	S	N	H	DL1000			
High Speed / Light cut	▲	▲	▲	▲	▲	▲	▲	▲	▲	
General Purpose	▲	▲	▲	▲	▲	▲	▲	▲	▲	
Roughing	▲	▲	▲	▲	▲	▲	▲	▲	▲	
Cat. No.	ACP100	ACP200	ACP300	ACK200	ACK300	ACM200	ACM300	H1	DL1000	Radius
AXMT 170508 PEER-L	▲	▲	▲	▲	▲			-	-	0,8
AXMT 170504 PEER-G	▲	▲	▲	▲	▲			-	-	0,4
170508 PEER-G	▲	▲	▲	▲	▲			-	-	0,8
170512 PEER-G	▲	▲	▲	▲	▲			-	-	1,2
170516 PEER-G	○	▲	▲	▲	▲			-	-	1,6
170520 PEER-G*	▲	▲	▲	▲	▲			-	-	2,0
170530 PEER-G*	▲	▲	▲	▲	▲			-	-	3,0
AXMT 170508 PEER-H	▲	▲	▲	▲	▲			-	-	0,8
170512 PEER-H	▲	▲	▲	▲	▲			-	-	1,2
AXMT 170504 PEER-E						▲	▲	-	-	0,4
170508 PEER-E						▲	▲	-	-	0,8
170512 PEER-E						▲	▲	-	-	1,2
170516 PEER-E						▲	▲	-	-	1,6
170520 PEER-E*						▲	▲	-	-	2,0
170530 PEER-E*						▲	▲	-	-	3,0
AXMT 170508 PEER-EH			▲			▲	▲	-	-	0,8
AXET 170502 PEFR-S	-	-	-	-	-	-	-	▲	▲	0,2
170504 PEFR-S	-	-	-	-	-	-	-	▲	▲	0,4
170508 PEFR-S	-	-	-	-	-	-	-	▲	▲	0,8

L - Low cutting force  
 G - General type  
 H - Strong cutting edge  
 E - For stainless steel / exotic alloy  
 EH - Strong edge for stainless steel / exotic alloy  
 S - For aluminium alloy  
 - Unable to produce  
 \* Cutter body modification is required

### Identification Details

**WEX 3 025 M12 Z2**

Cutter Series 3000 Series Cutter Diameter Mounting Screw Size No. of Teeth





## Recommended Cutting Conditions

### WEX3000 Series

Cutter: WEX30325E

Insert: AXMT170508PEER - □

Cutting Data:  $a_p = 5 \text{ mm}$ ,  $a_e = 16 \text{ mm}$ , dry

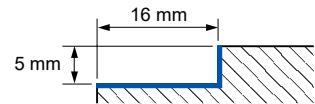

ISO	Material	HB	Chipbreaker	Coated Carbide											Diamond like Carbon Coated Carbide											
				ACP100			ACP200			ACP300			ACK200		ACK300		ACM200		ACM300		DL1000					
				Feed Rate (mm/tooth)																						
				0,12	0,25	0,35	0,12	0,25	0,35	0,12	0,25	0,35	0,12	0,25	0,35	0,12	0,25	0,35	0,12	0,25	0,35	0,05	0,15	0,25		
Cutting Speed $v_c$ (m/min)																										
P	Unalloyed steel, <0, 15%C, annealed	125	G	400	370	350	370	350	330	350	330	310														
	" , <0, 45%C, annealed	190	G	300	270	250	270	250	230	250	230	210														
	" , <0, 45%C, tempered	250	G	250	220	200	220	200	180	200	180	160														
	" , <0, 75%C, annealed	270	G	200	170	150	180	160	140	160	140	120														
	" , <0, 75%C, tempered	300	G	150	120	100	120	100	80	100	80	60														
	Low alloyed steel, annealed	180	G	280	250	230	250	230	210	230	210	190														
" , tempered	275	G	180	150	130	160	140	120	140	120	100															
" , tempered	300	G	160	130	110	140	120	100	120	100	80															
" , tempered	350	G	130	100	80	110	90	70	90	70	50															
High alloyed and tool steel, annealed	" , tempered	200	G	250	220	200	220	200	180	200	180	160														
	" , hardened	325	G	130	100	80	100	80	60	80	60	40														
M	Stainless steel, ferritic/martensitic, annealed	200	E														185	165	135	165	150	120				
	Martensitic, tempered	240	EH														170	150	120	150	135	110				
	Austenitic, plunged	180	E														200	180	150	180	160	135				
K	Grey cast iron		G										300	270	250	270	250	230								
	Nodular cast iron		G										200	170	150	170	150	130								
S	High tempered resist. alloys, Fe based, annealed	300	E														50	30	45	25						
	" , hardened	330	E														50	30	45	25						
N	Aluminium alloy, Si < 13%		S																				1000	750	500	
	Aluminium alloy, Si > 13%		S																				250	200	170	
	Copper alloy		S																				350	330	300	

The above recommended cutting conditions are meant as a guide. Actual conditions will depend on the individual machine, work shape and clamping. They will need to be adjusted according to machine rigidity, work clamp rigidity, cutting depth and other factors.

For groove milling, reduce the feed rate approximately 70 % of the corresponding value shown above.

## Recommended Values for Helical Milling and Ramping

### Helical Boring

≤ Min. Diameter

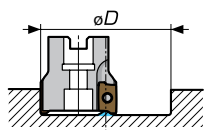

Center uncut portion cannot be removed by traverse cutting with the same cutter.

≥ Max. Diameter

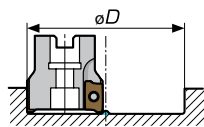

Center uncut portion can be removed by traverse cutting with the same cutter.

### Plunging

Use at ≤ RMPX

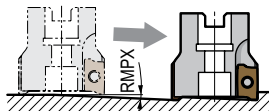

### Recommended Values for Helical and Plunging

Cutter External Diameter DC	WEX1000 (AXMT06...)			WEX2000 (AX□T12...)			WEX3000 (AX□T17...)		
	Helical		Plunging	Helical		Plunging	Helical		Plunging
	Work Diameter Min.	Work Diameter Max.	Max. Ramping Angle	Work Diameter Min.	Work Diameter Max.	Max. Ramping Angle	Work Diameter Min.	Work Diameter Max.	Max. Ramping Angle
10	16,0	18,0	2°30'						
12	20,0	22,0	1°45'						
14	24,0	26,0	1°25'	25,0	27,0	1°40'			
16	28,0	30,0	1°00'	29,0	31,0	1°20'			
18	32,0	34,0	0°45'	33,0	35,0	1°10'			
20	36,0	38,0	0°30'	37,0	39,0	1°00'			
22				41,0	43,0	0°50'			
25	46,0	48,0	0°30'	47,0	49,0	0°45'	44,5	48,0	1°30'
28				53,0	55,0	0°45'	50,5	54,0	1°10'
30				57,0	59,0	0°40'	54,5	58,0	1°10'
32	60,0	62,0	0°25'	61,0	63,0	0°35'	58,5	62,0	1°00'
35							64,5	68,0	0°50'
40	76,0	78,0	0°20'	77,0	79,0	0°25'	74,5	78,0	0°45'
50	96,0	98,0	0°15'	97,0	99,0	0°20'	94,5	98,0	0°30'
63	122,0	124,0	0°10'	123,0	125,0	0°15'	120,5	124,0	0°20'
80							154,5	158,0	0°15'
100									
125									

The above recommended values are for a nose radius of 0,8 mm.



### Overview

Based on our proven Wavemill design this new range of WAX cutters is capable of rough and finishing Aluminium Alloys and other Non Ferrous Metals. It is ideal for high productivity Aluminium machining to exacting tolerances in the Aircraft, Electronics, and Automotive industries. The award winning Auroracoat DLC (diamond like carbon) inserts resist chip adhesion and substantially increase both tool life and productivity when dry machining Aluminium helping customers boost compliance with ISO14001 accreditation standards

### Advantages

- High Productivity
- Dry machining capability with MQL system
- DLC (diamond like carbon) inserts
- True 90 degree shoulder milling
- Chip adhesion resistance
- Wide range of nose radius

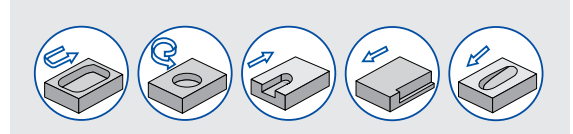

### Ramping (Slant Milling)

Maximum ramping angle ( $\alpha_{max}$ ) depends on cutter diameter.  
Minimum milling length (L min) is the ramping distance required to reach the maximum cutting depth ( $a_p$  max) at the maximum ramping angle of that cutter.  
Minimum milling length (L) for any depth can be calculated by the equation below:

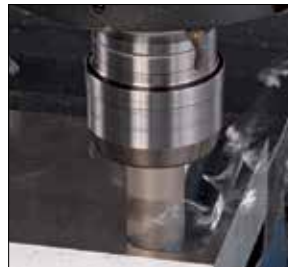
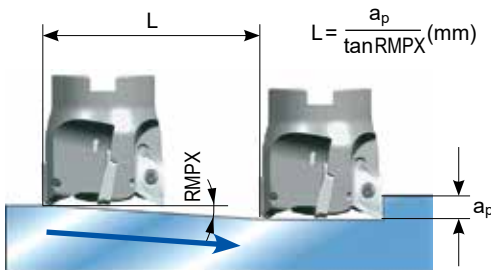

### WAX3000 E/EL Type (mm)

Cutter Diameter DC	Ramping Angle RMPX max.	Depth-of Cut $a_p$ max.	Milling Distance L min
20	8°	10	72
25	17°	10	33
32	12°	10	47
40	9°	10	64

### WAX3000 RS Type (mm)

Cutter Diameter DC	Ramping Angle RMPX max.	Depth-of Cut $a_p$ max.	Milling Distance L min
50	7°	10	82
60	5°	10	115
80	3°	10	191
100	3°	10	191
125	2°	10	287

### Helical Milling

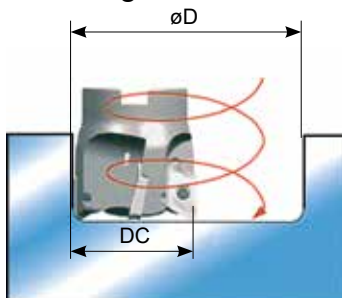

### Helical Milling Diameter (mm)

Cutter Diameter DC	Milling Diameter øD	
	Min.	Max.
20	22	33
25	29	43
32	43	57
40	59	73
50	79	93
63	105	119
80	139	153
100	179	193
125	229	243

### Maximum Allowable Spindle Speed

Cutter Diameter DC	Spindle Revolution n (min <sup>-1</sup> )	Cutting Speed $v_c$ (m/min)
20	14.000	880
25	29.000	2.200
32	25.000	2.500
40	23.000	2.900
50	20.000	3.100
63	18.000	3.500
80	16.000	4.000
100	14.000	4.400
125	13.000	5.100

### Recommended Cutting Conditions

Work Material	Aluminum Alloy
Cutting Speed	600–1.200 m/min
Feed Rate	0,05–0,25 mm/tooth

# "Wave Mill" Series WAX 3000 E/EL

16-18mm 90°

Axial rake angle 6°  
Radial rake angle 19-25°

## (Endmill)

Short Type "E"  
Long Type "EL"

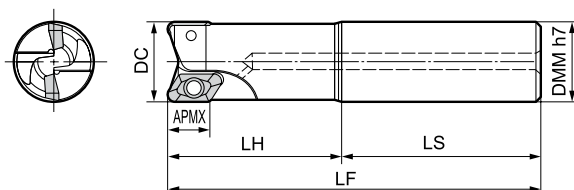

## Body

(For inserts with nose radius ≤ 3,2 mm)

Cat. No.	Stock	Dimensions (mm)					No. of teeth	Weight (Kg)
		DC	DMM	LF	LH	LS		
WAX 3020 E -3.2	●	20	20	130	60	70	1	0,25
WAX 3025 E -3.2	●	25	25	140	60	80	2	0,42
3025 EL-3.2	●	25	25	200	60	140	2	0,63
WAX 3032 E -3.2	●	32	32	150	70	80	2	0,75
3032 EL-3.2	●	32	32	220	70	150	2	1,2
WAX 3040 E -3.2	●	40	32	160	70	90	3	1,0
3040 EL-3.2	●	40	32	220	70	150	3	1,4

## Body

(For inserts with nose radius ≥ 4,0 mm)

Cat. No.	Stock	Dimensions (mm)					No. of teeth	Weight (Kg)
		DC	DMM	LF	LH	LS		
WAX 3020 E -4.0	○	20	20	130	60	70	1	0,25
WAX 3025 E -4.0	●	25	25	140	60	80	2	0,42
3025 EL-4.0	●	25	25	200	60	140	2	0,63
WAX 3032 E -4.0	●	32	32	150	70	80	2	0,75
3032 EL-4.0	●	32	32	220	70	150	2	1,2
WAX 3040 E -4.0	○	40	32	160	70	90	3	1,0
3040 EL-4.0	●	40	32	220	70	150	3	1,4

## Inserts for WAX 3000 Type

Application	DLC Coated	Carbide	Dimensions (mm)						
High Speed / Light cut	●	●	APMX	INSL	BS	RE	S	D1	
General Purpose	●	●							
Roughing									
Cat. No.	DL 1000	H1	Dimensions (mm)						
AECT 160404 PEFRA	●	●	18	16,4	1,4	0,4	5	4,4	
160408 PEFRA	●	●	18	16,4	1,0	0,8	5	4,4	
160412 PEFRA	●	●	18	16,4	0,6	1,2	5	4,4	
160416 PEFRA	●	●	17,5	16,4	0,5	1,6	5	4,4	
160420 PEFRA	●	●	17,5	16,4	0,5	2,0	5	4,4	
160430 PEFRA	●	●	17	16,4	0,7	3,0	5	4,4	
160432 PEFRA	●	●	17	16,4	0,5	3,2	5	4,4	
AECT 160440 PEFRA	●	●	16,5	16,4	0,5	4,0	5	4,4	
160450 PEFRA	●	●	16	16,4	0,4	5,0	5	4,4	

## Spare Parts

Insert Screw	Insert Wrench	Applicable Endmill
		WAX 3000 E/EL
BFTX 0408	3,0 (N·m)	TRD 15

# "Wave Mill" Series WAX 4000 E/EL

22-24mm 90°

Axial rake angle	6°
Radial rake angle	19-25°



## (Endmill)

Short Type "E"  
Long Type "EL"

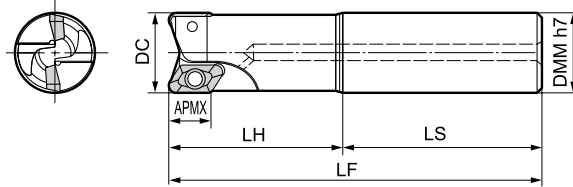

## Body

(For inserts with nose radius  $\leq 3,2$  mm)

Cat. No.	Stock	Dimensions (mm)					No. of teeth	Weight (Kg)
		DC	DMM	LF	LH	LS		
WAX 4025E -3.2	<input type="checkbox"/>	25	25	140	60	80	1	0,41
4025EL-3.2	<input type="checkbox"/>	25	25	200	60	140	1	0,63
WAX 4032E -3.2	<input type="checkbox"/>	32	32	150	70	80	1	0,72
4032EL-3.2	<input type="checkbox"/>	32	32	220	70	150	1	1,2
WAX 4040E -3.2	<input type="checkbox"/>	40	32	160	70	90	2	0,88
4040EL-3.2	<input type="checkbox"/>	40	32	220	70	150	2	1,2

## Body

(For inserts with nose radius  $\geq 4,0$  mm)



Cat. No.	Stock	Dimensions (mm)					No. of teeth	Weight (Kg)
		DC	DMM	LF	LH	LS		
WAX 4025E -4.0	<input type="checkbox"/>	25	25	140	60	80	1	0,41
4025EL-4.0	<input type="checkbox"/>	25	25	200	60	140	1	0,63
WAX 4032E -4.0	<input type="checkbox"/>	32	32	150	70	80	1	0,72
4032EL-4.0	<input type="checkbox"/>	32	32	220	70	150	1	1,2
WAX 4040E -4.0	<input type="checkbox"/>	40	32	160	70	90	2	0,88
4040EL-4.0	<input type="checkbox"/>	40	32	220	70	150	2	1,2

## Inserts for WAX 4000 Type

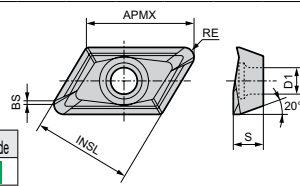
Application	DLC Coated	Carbide	Dimensions (mm)						
High Speed / Light cut	<input checked="" type="checkbox"/>	<input checked="" type="checkbox"/>	APMX	INSL	BS	RE	S	D1	
General Purpose	<input type="checkbox"/>	<input checked="" type="checkbox"/>							
Roughing									
Cat. No.	DL 1000	HE	APMX	INSL	BS	RE	S	D1	
AECT 220604 PEFRA	<input type="checkbox"/>	<input type="checkbox"/>	24	21,8	1,5	0,4	6,35	6,0	
220608 PEFRA	<input type="checkbox"/>	<input type="checkbox"/>	24	21,8	1,2	0,8	6,35	6,0	
220612 PEFRA	<input type="checkbox"/>	<input type="checkbox"/>	24	21,8	0,8	1,2	6,35	6,0	
220616 PEFRA	<input type="checkbox"/>	<input type="checkbox"/>	24	21,8	0,4	1,6	6,35	6,0	
220620 PEFRA	<input type="checkbox"/>	<input type="checkbox"/>	24	21,8	0,5	2,0	6,35	6,0	
220630 PEFRA	<input type="checkbox"/>	<input type="checkbox"/>	23	21,8	0,6	3,0	6,35	6,0	
220632 PEFRA	<input type="checkbox"/>	<input type="checkbox"/>	23	21,8	0,4	3,2	6,35	6,0	
AECT 220640 PEFRA	<input type="checkbox"/>	<input type="checkbox"/>	22	21,8	1,2	4,0	6,35	6,0	
220650 PEFRA	<input type="checkbox"/>	<input type="checkbox"/>	22	21,8	0,4	5,0	6,35	6,0	



## Spare Parts

Insert Screw	Insert Wrench	Applicable Endmill
		
BFTX 0509 N	TRD 20	$\varnothing 25 - \varnothing 32$
BFTX 0511 N	TRD 20	$\varnothing 40 - \varnothing 125$



# "Wave Repeater Mill" WRX Type



## General Features

The WRX Wave repeater end mill system features AXMT style inserts vertically mounted and positioned to provide a long continuous cutting edge suitable for deep shoulder milling. Designed to run at elevated feed rates the soft cutting action reduces cutting resistance, vibration and noise to substantially improve tool life and surface finish.

Available with our new generation Super FF and Super ZX coated inserts for unbeatable performance.

## Product Range

- WRX 2000 series with 12 mm inserts
- WRX 3000 series with 17 mm inserts
- Cutter Diameters - 20 mm ( $a_p = 18$  mm) to 100 mm ( $a_p = 53$  mm)
- Special Order Options – WRX Cutter with integrated arbor  
Shell type with detachable head
- Wide ISO Application Range – P/M/K/N classification

## Advantages

- Optimised insert positions reduce cutting resistance and vibration
- Integral coolant improves chip flow
- Primary chip slot for smooth and fast chip evacuation
- Optimised insert pocket maximises rigidity
- Bottom edge support improves tool life and cutting performance

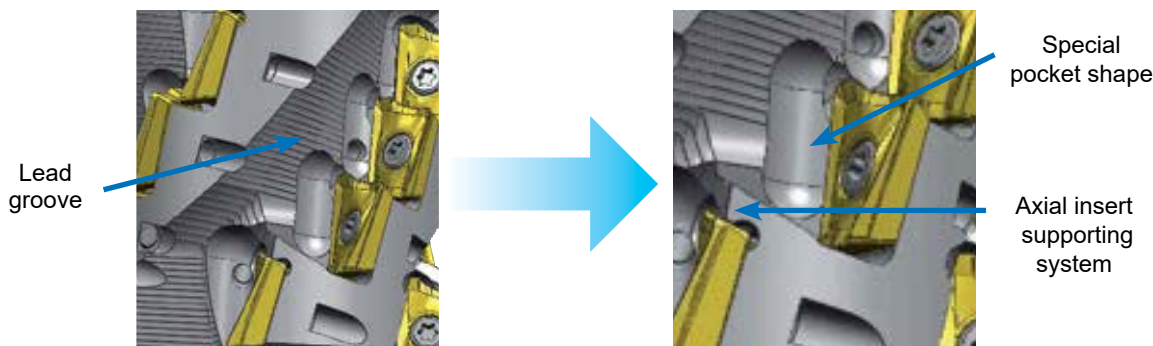

## Cutting Resistance Comparison

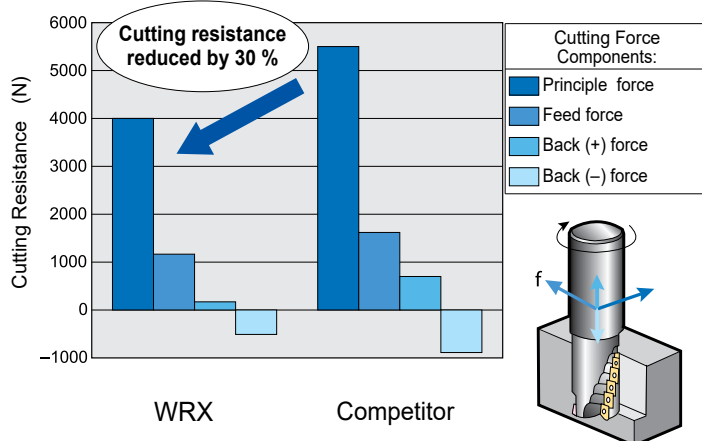

## Vibration Comparison

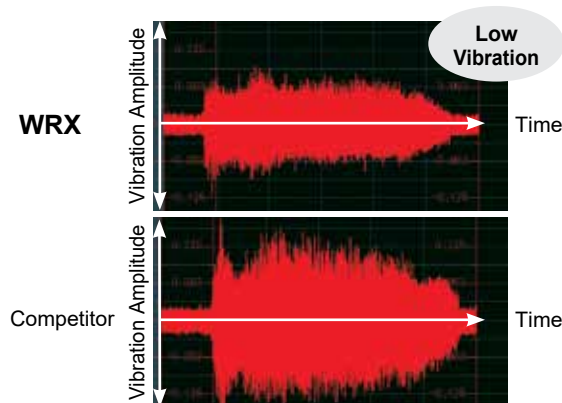

Work Material: C50  
Tool: WRX2025RH27E25  
Cutting Conditions:  $v_c = 100$  m/min,  $f_z = 0,15$  mm/tooth  
 $a_p = 25$  mm,  $a_e = 10$  mm, dry

Work Material: C50  
Tool: WRX3080RH53F32  
Cutting Conditions:  $v_c = 150$  m/min,  $f_z = 0,15$  mm/tooth  
 $a_p = 25$  mm,  $a_e = 10$  mm, dry

# WRX 2000 Series with AXMT 12 mm inserts

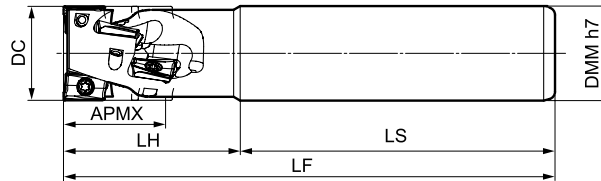
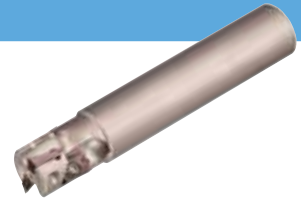



## Body (Cylindrical Shank Type)

Cat. No.	Stock	Dimensions (mm)						No. of teeth	No. of rows	Effective teeth
		DC	APMX	DMM	LF	LH	LS			
WRX2020RH18E20	●	20	18	20	120	40	80	4	2	2
WRX2020RH36E20	□	20	36	20	130	45	85	4	4	1
WRX2025RH18E25	●	25	18	25	130	45	85	6	2	3
WRX2025RH27E25	●	25	27	25	130	45	85	6	3	2
WRX2032RH18E32	□	32	18	32	140	50	90	8	2	4
WRX2032RH27E32	●	32	27	32	130	45	85	9	3	3
WRX2040RH18E40	□	40	18	40	160	40	120	10	2	5
WRX2040RH36E40	□	40	36	40	130	45	85	16	4	4

## Body (Weldon Shank Type)

Cat. No.	Stock	Dimensions (mm)						No. of teeth	No. of rows	Effective teeth
		DC	APMX	DMM	LF	LH	LS			
WRX2020RH18W20	●	20	18	20	120	40	80	4	2	2
WRX2020RH36W20	□	20	36	20	130	45	85	4	4	1
WRX2025RH18W25	●	25	18	25	130	45	85	6	2	3
WRX2025RH27W25	●	25	27	25	130	45	85	6	3	2
WRX2032RH18W32	□	32	18	32	140	50	90	8	2	4
WRX2032RH27W32	●	32	27	32	130	45	85	9	3	3
WRX2040RH18W40	□	40	18	40	160	40	120	10	2	5
WRX2040RH36W40	□	40	36	40	130	45	85	16	4	4

## Spare Parts (WRX 2000)

Screw	Wrench
	
BFTX 0306 IP	TRDR 08 IP

## Identification Details

**WRX 20 25 R H 27 W 25**

Insert Size | Cutting Direction | Cutting Edge Length | Arbor Diameter

Tool øD | Inner coolant | Arbor Type

E - Straight Shank  
W - Weldon Shank  
F - Shell Type

## Inserts (Same as for Wavemill WEX 2000 Type)

Application	Coated Carbide							Carbide	DLC	
	P	M	K	S	N	H	DL1000			
High Speed / Light cut	P		K	S	N					
General Purpose		P	K	S	N					
Roughing		P	K	S	N					
Cat. No.	ACP100	ACP200	ACP300	ACK200	ACK300	ACM200	ACM300	H1	DL1000	Radius RE
AXMT 123504 PEER-G	▲	▲	▲	▲	▲			-	-	0,4
123508 PEER-G	▲	▲	▲	▲	▲			-	-	0,8
123512 PEER-G	▲	▲	▲	▲	▲			-	-	1,2
AXMT 123504 PEER-H	▲	▲	▲	▲	▲			-	-	0,4
123508 PEER-H	▲	▲	▲	▲	▲			-	-	0,8
123512 PEER-H	▲	▲	▲	▲	▲			-	-	1,2
AXMT 123504 PEER-E						▲	▲	-	-	0,4
123508 PEER-E						▲	▲	-	-	0,8
123512 PEER-E						▲	▲	-	-	1,2
AXMT 123508 PEER-EH						▲	▲	-	-	0,8
AXET 123502 PEFR-S	-	-	-	-	-	-	-	▲	▲	0,2
123504 PEFR-S	-	-	-	-	-	-	-	▲	▲	0,4
123508 PEFR-S	-	-	-	-	-	-	-	▲	▲	0,8

- Unable to produce  
G - General type  
H - Strong cutting edge  
E - For stainless steel / exotic alloy  
EH - Strong edge for stainless steel / exotic alloy  
S - For aluminium alloy

## Application Examples

### Example

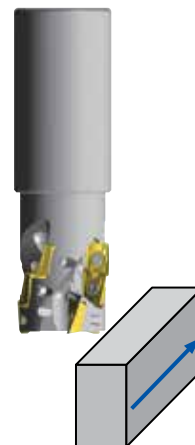

Work Material	Construction Machine Parts (USt-42-2)		
	Body	Sumitomo	Competitor
Tool	WRX2000 Weldon shank	Ø 38,1	
	Insert	AXMT	18 mm
	Insert grade	ACP200	PVD Type
	Tool dia. (mm)	38,1	38,1
	Total teeth	24	16
Cutting Data	Effective teeth	4	4
	Cutting speed (m/min)	180	137
	Feed (mm/t)	0,09	0,1
	Axial depth of cut (mm)	38,1	38,1
	Radial width of cut (mm)	3,2	3,2
Result	Coolant	Wet	Wet
	Tool life / Cutting edge	60	40
Benefits	1,5 times longer tool life 30 % increased productivity		

# WRX 3000 Series with AXMT 17 mm inserts

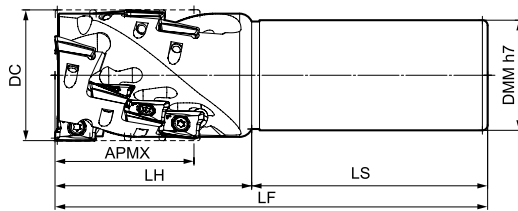

## Body (Cylindrical Shank Type)





Cat. No.	Stock	Dimensions (mm)						No. of teeth	No. of rows	Effective teeth
		DC	APMX	DMM	LF	LH	LS			
WRX3032RH40E32	●	32	40	32	150	65	85	6	3	2
WRX3040RH27E40	□	40	27	40	180	60	120	6	2	3
WRX3040RH40E40	●	40	40	40	150	65	85	9	3	3
WRX3050RH27E40	□	50	27	40	180	60	120	8	2	4
WRX3050RH53E40	●	50	53	40	165	75	90	12	4	3

## Body (Weldon Shank Type)



Cat. No.	Stock	Dimensions (mm)						No. of teeth	No. of rows	Effective teeth
		DC	APMX	DMM	LF	LH	LS			
WRX3040RH27W40	□	40	27	40	180	60	120	6	2	3
WRX3040RH40W40	●	40	40	40	150	65	85	9	3	3
WRX3050RH27W40	□	50	27	40	180	60	120	8	2	4
WRX3050RH53W40	●	50	53	40	165	75	90	12	4	3

## Spare Parts (WRX 3000)

Screw	Wrench
 3.0 (mm)	
BFTX 0409 IP	TRDR 15 IP

## Inserts (Same as for Wavemill WEX 3000 Type)

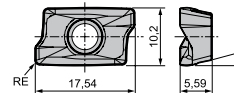

Application	Coated Carbide						Carbide	DLC
	P	P	K	M	M	M		
High Speed / Light cut	■		■	■	■	■	■	■
General Purpose		■		■	■	■	■	■
Roughing		■	■	■	■	■	■	■

  

Cat. No.	ACP100	ACP200	ACP300	ACK200	ACK300	ACM200	ACM300	H1	DL1000	Radius
	▲	▲	▲	▲	▲	▲	▲	—	—	RE
AXMT 170508 PEER-L	▲	▲	▲	▲	▲			—	—	0.8
AXMT 170504 PEER-G	▲	▲	▲	▲	▲			—	—	0.4
170508 PEER-G	▲	▲	▲	▲	▲			—	—	0.8
170512 PEER-G	▲	▲	▲	▲	▲			—	—	1.2
170516 PEER-G	○	▲	▲	▲	▲			—	—	1.6
170520 PEER-G*	▲	▲	▲	▲	▲			—	—	2.0
170530 PEER-G*	▲	▲	▲	▲	▲			—	—	3.0
AXMT 170508 PEER-H	▲	▲	▲	▲	▲			—	—	0.8
170512 PEER-H	▲	▲	▲	▲	▲			—	—	1.2
AXMT 170504 PEER-E						▲	▲	—	—	0.4
170508 PEER-E						▲	▲	—	—	0.8
170512 PEER-E						▲	▲	—	—	1.2
170516 PEER-E						▲	▲	—	—	1.6
170520 PEER-E*						▲	▲	—	—	2.0
170530 PEER-E*						▲	▲	—	—	3.0
AXMT 170508 PEER-EH			▲			▲	▲	—	—	0.8
AXET 170502 PEFR-S	—	—	—	—	—	—	—	▲	▲	0.2
170504 PEFR-S	—	—	—	—	—	—	—	▲	▲	0.4
170508 PEFR-S	—	—	—	—	—	—	—	▲	▲	0.8

L – Low cutting force  
 G – General type  
 H – Strong cutting edge  
 E – For stainless steel  
 EH – Strong edge for stainless steel  
 S – For aluminium  
 \* Cutter body modification is required.

## Application Examples

### Example 1

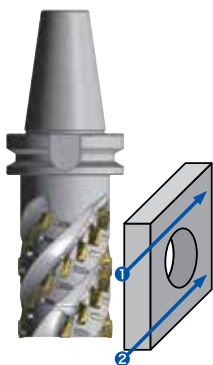

Work Material	Automotive Component / Cast Iron		
	Body	Sumitomo	Competitor
Tool	Body	WRX3000 Type Integrated Arbor	Ø 50
	Insert	AXMT	18 mm
	Insert grade	ACK300	PVD Type
	Tool dia. (mm)	50	50
	Total teeth	15	12
	Effective teeth	3	3
Cutting Data	Cutting speed (m/min)	78	78
	Feed (mm/t)	0,13	0,13
	Axial depth of cut (mm)	45	45
	Radial width of cut (mm)	5	5
	Coolant	Dry	Dry
Result	Tool life / Cutting edge	500 min	300 min
Benefits	1,7 times longer tool life		

### Example 2















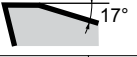

Work Material	Machine Parts / Stainless Steel		
	Body	Sumitomo	Competitor
Tool	Body	WRX3040RH40E40	Ø 40
	Insert	AXMT	18 mm
	Insert grade	ACP300	PVD Type
	Tool dia. (mm)	40	40
	Total teeth	9	6
	Effective teeth	3	2
Cutting Data	Cutting speed (m/min)	125	125
	Feed (mm/t)	0,2	0,2
	Axial depth of cut (mm)	40	40
	Radial width of cut (mm)	5	5
	Coolant	Wet	Wet
Result	Tool life / Cutting edge	20	5 ~ 10
Benefits	Stable machining, double tool life with no breakage		

→ G59

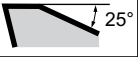
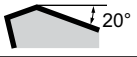
# "Wave Repeater Mill" WRX Type

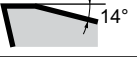
## Chipbreaker Selection

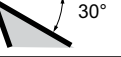
Work Material	Steel, Cast Iron			Stainless Steel		Aluminium
	L	G	H	E	EH	S
Chipbreaker Type						
Feature	Low cutting force	General purpose	Strong cutting edge	E type for smooth cutting	Strong cutting edge	Sharp cutting edge
2000 Type Figure	—					
3000 Type Figure						
Application	Light cut, low rigidity milling and less burrs	General to Interrupted milling	Roughing, heavy interrupted and hardened steel milling	Light cutting to general purpose	Heavy interrupted machining	Aluminium alloy and non-ferrous metal

## Ramping (Slant Milling)

Tool Diameter	Max. Ramping Angle	
	WRX 2000 Typ	WRX 3000 Typ
20	4°	
25	2°	
32	1°30'	
40	1°	2°
50	0°30'	1°
63		0°30'
80		0°30'
100		Not possible

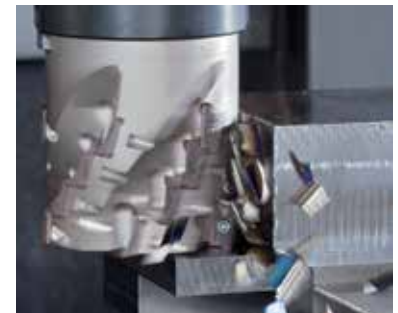

## Recommended Cutting Conditions

Tool: WRX 3050 RH53 F22, DC = 50 mm,  $a_p = 50$  mm

ISO	Work Material	Property, Condition	Hardness (HB)	Grades (optimum grade in bold letters)	Chip Breaker	Recommended cutting speed and feed / tooth according to width of cut ( $a_e/DC$ ) - must be adjusted to actual machine and workpiece conditions.					
						10%		25%		> 50%	
						$v_c$	$f_z$	$v_c$	$f_z$	$v_c$	$f_z$
P	Steel, carbon steel	< 0,15% C, annealed	125	ACP 100, <b>ACP 200</b> , ACP 300	L - G	170 – 215 – 240	0,21 – 0,28 – 0,35	160 – 195 – 220	0,16 – 0,21 – 0,26	130 – 160 – 180	0,08 – 0,10 – 0,13
		< 0,45% C, annealed	190	ACP 100, <b>ACP 200</b> , ACP 300	L - G	160 – 195 – 220	0,21 – 0,28 – 0,35	140 – 175 – 190	0,16 – 0,21 – 0,26	110 – 140 – 160	0,08 – 0,10 – 0,13
		< 0,45% C, tempered	250	ACP 100, <b>ACP 200</b> , ACP 300	L - G - H	140 – 180 – 200	0,19 – 0,26 – 0,32	130 – 165 – 180	0,14 – 0,19 – 0,24	100 – 130 – 140	0,08 – 0,10 – 0,13
		< 0,75% C, annealed	270	ACP 100, <b>ACP 200</b> , ACP 300	L - G - H	140 – 170 – 190	0,19 – 0,26 – 0,32	120 – 155 – 170	0,14 – 0,19 – 0,24	100 – 130 – 140	0,07 – 0,10 – 0,12
		< 0,75% C, tempered	300	ACP 100, <b>ACP 200</b> , ACP 300	L - G - H	130 – 165 – 180	0,19 – 0,26 – 0,32	120 – 150 – 170	0,14 – 0,19 – 0,24	100 – 120 – 130	0,07 – 0,10 – 0,12
	Low alloyed steel	annealed	180	ACP 100, <b>ACP 200</b> , ACP 300	G - H	130 – 165 – 180	0,18 – 0,24 – 0,30	120 – 150 – 170	0,13 – 0,18 – 0,22	100 – 120 – 130	0,07 – 0,09 – 0,11
		tempered	275	ACP 100, <b>ACP 200</b> , ACP 300	G - H	130 – 160 – 180	0,17 – 0,23 – 0,28	120 – 145 – 160	0,12 – 0,16 – 0,20	100 – 120 – 130	0,07 – 0,09 – 0,11
		tempered	300	ACP 100, <b>ACP 200</b> , ACP 300	G - H	110 – 140 – 160	0,16 – 0,22 – 0,27	100 – 130 – 140	0,11 – 0,15 – 0,19	90 – 110 – 120	0,07 – 0,09 – 0,11
		tempered	350	ACP 100, <b>ACP 200</b> , ACP 300	G - H	100 – 130 – 140	0,16 – 0,21 – 0,26	100 – 120 – 130	0,11 – 0,15 – 0,19	80 – 100 – 110	0,06 – 0,08 – 0,10
	High alloyed and tool steel	annealed	200	<b>ACP 100</b> , ACP 200	G - H	70 – 85 – 90	0,15 – 0,21 – 0,26	60 – 80 – 90	0,11 – 0,14 – 0,18	60 – 70 – 80	0,06 – 0,08 – 0,10
tempered		325	ACP 100, <b>ACP 200</b>	G - H	30 – 35 – 40	0,14 – 0,19 – 0,24	30 – 35 – 40	0,10 – 0,14 – 0,17	20 – 30 – 30	0,06 – 0,08 – 0,10	
M	Stainless steel, ferritic/martensitic	annealed	200	ACP 200, <b>ACP 300</b>	L - G - H	120 – 150 – 170	0,15 – 0,20 – 0,25	110 – 135 – 150	0,11 – 0,14 – 0,18	90 – 110 – 120	0,07 – 0,09 – 0,11
	Stainless, martensitic	tempered	240	ACP 200, <b>ACP 300</b>	L - G - H	100 – 125 – 140	0,16 – 0,22 – 0,27	90 – 115 – 130	0,12 – 0,16 – 0,20	80 – 100 – 110	0,07 – 0,10 – 0,12
	Stainless, austenitic	plunged	180	ACM 200, <b>ACM 300</b>	L - G	80 – 95 – 110	0,15 – 0,20 – 0,25	70 – 85 – 90	0,11 – 0,14 – 0,18	60 – 70 – 80	0,06 – 0,08 – 0,10
K	Gray cast iron	GG	180	<b>ACK 200</b> , ACK 300	G - H	190 – 240 – 270	0,19 – 0,26 – 0,32	180 – 220 – 240	0,14 – 0,19 – 0,24	140 – 170 – 190	0,09 – 0,12 – 0,15
	Nodular cast iron	GGG	250	<b>ACK 200</b> , ACK 300	G - H	140 – 170 – 190	0,16 – 0,21 – 0,26	120 – 155 – 170	0,12 – 0,16 – 0,20	100 – 130 – 140	0,07 – 0,10 – 0,12
S	Exotic alloys (Resistant alloys, Ti + Ni alloys)	Fe based, annealed	200	ACK 200, <b>ACK 300</b>	L - G	40 – 45 – 50	0,12 – 0,16 – 0,21	30 – 40 – 45	0,08 – 0,11 – 0,14	30 – 35 – 40	0,07 – 0,09 – 0,11
		hardened	280	ACK 200, <b>ACK 300</b>	L - G	15 – 20 – 25	0,10 – 0,14 – 0,17	10 – 15 – 20	0,07 – 0,10 – 0,12	10 – 15 – 20	0,05 – 0,07 – 0,09
N	Aluminum alloy	Si < 13%		DL 1000, H1	S	510 – 635 – 710	0,23 – 0,31 – 0,38	460 – 580 – 640	0,17 – 0,22 – 0,28	390 – 485 – 540	0,08 – 0,12 – 0,14
		Si ≥ 13%		DL 1000, H1	S	150 – 190 – 210	0,19 – 0,25 – 0,32	140 – 175 – 190	0,14 – 0,18 – 0,23	130 – 165 – 180	0,08 – 0,10 – 0,13
	Copper alloy			DL 1000, H1	S	320 – 405 – 450	0,15 – 0,21 – 0,26	300 – 370 – 410	0,13 – 0,16 – 0,22	240 – 300 – 330	0,07 – 0,10 – 0,12

- Dry machining is recommended (air cooling) - if lubricant is used, we recommend CVD coated grades (ACP100 / ACK200) or tough PVD grades (ACP300 / ACK300).  
 - Insert geometry: L type for low cutting forces, thinly coated components. G type for general application, H type offers high cutting edge stability for rough and heavy cutting conditions.



## General Features

### Stable and Reliable Tool Life in Titanium Roughing

With combination of high toughness grade ACM300 and optimized cutting edge shape, stable and reliable tool life are achieved in roughing application of Titanium.

### Suitable for Titanium Structure Parts for Aircraft

MTIX cutter with wide range of insert nose-radius and large ramping angle availability is suitable for variable application of titanium structure parts for aircraft.

### Large Application Range

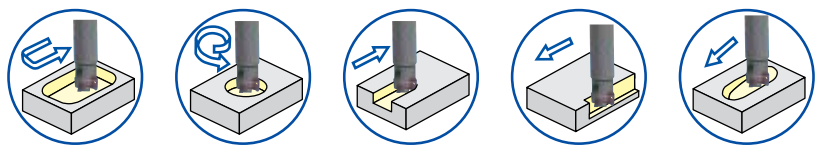

ISO	Grade	Coating Thickness (µm)	Features
<b>S</b>	ACM300	3	Realises superb stability in machining of Titanium, due to a high-strength carbide substrate and highly chipping-resistance coating.

## Recommended Cutting Conditions

Min. - Optimum - Max.

ISO	Material	Cutting Speed (m/min)	Feed Rate (mm/t)	$a_p$ (mm)	Grade
<b>S</b>	Titanium	30-60-90	0,05-0,10-0,15	<13	ACM300

## Ramping / Helical Milling Upper Limits

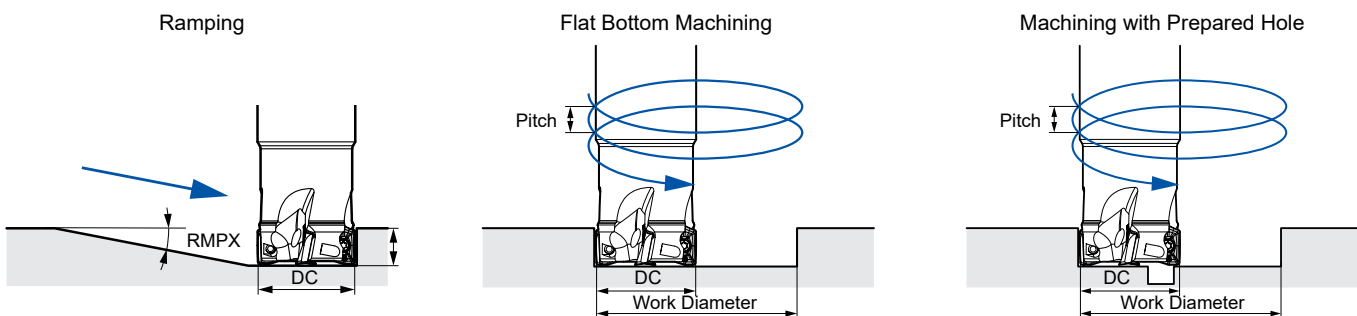

Tools			Flat Bottom Machining				Machining with Prepared Hole	
DC Ø (mm)	Nose Radius	Ramping	DC Ø (mm)	Nose Radius	Max. Machining Diam. (mm)	Max. Pitch (mm/rev)	Min. Machining Diam. (mm)	Max. Pitch (mm/rev)
Ø 32	RE ≥ 5,0	8,4	Ø 32	4,0	55,3	13,0	55,2	13,0
	RE ≤ 4,0	12,2		0,8	61,3	13,0		
Ø 50	RE ≥ 5,0	3,6	Ø 50	4,0	91,6	11,2	91,6	11,2
	RE ≤ 4,0	5,6		0,8	97,3	13,0		
Ø 63	RE ≥ 5,0	2,5	Ø 63	4,0	117,6	10,1	117,6	10,1
	RE ≤ 4,0	3,9		0,8	123,3	11,7		



# MTIX 16000 Type

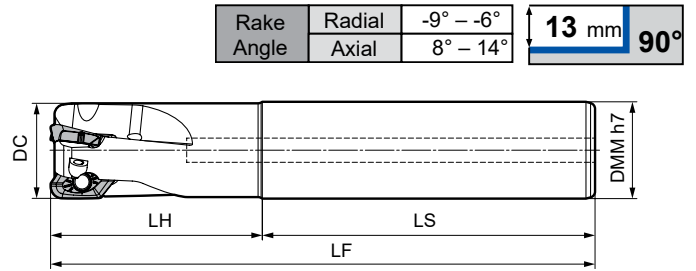
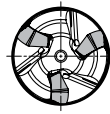

## Body - MTIX (Shankl Type)

Dimensions (mm)

Insert Radius RE	Cat. No.	Stock	DC	DMM	LF	LH	LS	No. of Teeth	Weight (kg)
≤ 4,0	MTIX 16032E03	●	32	32	180	70	110	3	0,96
≥ 5,0	MTIX 16032E03-5,0	●	32	32	180	70	110	3	0,96

→ G61

Inserts are sold separately.

## Spare Parts

Applicable Cutters	Insert Screw	Wrench	Handle Grip	Wrench Bit
MTIX 16032E03(-5,0)	BFTX0409IP 3,0	TRDR15IP	-	-

## Identification Details

<b>MTIX</b>	<b>16</b>	<b>032</b>	<b>E</b>	<b>05</b>
Cutter Series	Insert Size	Cutter Diameter	Round Shank	Number of Teeth

## Inserts

Application	Coated Carbide	Dimensions (mm)		
High Speed / Light Cut				
General Purpose	<b>S</b>			
Roughing	<b>S</b>			
Cat. No.	ACM300	RE	Fig.	
XOMT 160508PEER-E	●	0,8	1	Fig. 1
160512PEER-E	●	1,2	1	
160516PEER-E	●	1,6	1	Fig. 2
160520PEER-E	●	2,0	1	
160530PEER-E	●	3,0	1	
160540PEER-E	●	4,0	1	
160550PEER-E	●	5,0	2	
160560PEER-E	●	6,0	2	
160564PEER-E	●	6,35	2	

Fig. 1: Dimensions 11, 21,5, 5,5, 20°

Fig. 2: Dimensions 11, 18,1, 4,7, 20°

Inserts with nose radius of RE ≥ 5,0 are for use with bodies that have a "-5,0" part number suffix

## Precautions for Mounting

- Clean the mounting seat and contact parts.
- Apply screw lubrication to the screw thread as well as the screw head face to prevent seizure.
- While pressing the insert solidly against the seat surface, tighten at the screws with the included wrench.
- After tightening, check that there are no gaps between the surfaces.



Cutter Body	MTIX16 ____	MTIX16 ____ -5,0
Insert Radius RE ≤ 4,0 mm	OK	Not recommended. The insert has no support from the cutter body.
Insert Radius RE ≥ 4,0 mm	OK with modification ↑ 1,5 mm less height	OK
Modification method	① Grind 1,5 mm from top ② Add chamfer 4,5 mm	

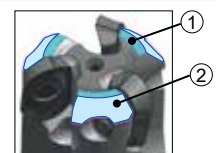



# "Wave Ball Mill" for Roughing WBMR Type



## ■ Features

Particularly suitable for die mold machining the WBMR replaceable insert ball nose endmill efficiently roughs complex profiles.

Its high feed rate capability is a direct result of a sharp cutting edge which is maintained during the cutting cycle by the special cemented carbide substrate working in parallel with the ultra hard ZX coating.

- Advantages
  - Wave shaped cutting edge
  - Economical M class insert
  - Precise clamping
  - High feed rate capability

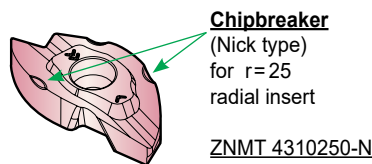

## ■ Performance

### ● Cutting Resistance

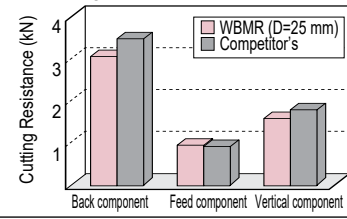

Cutting Conditions (Shoulder milling, downcut)  
 $v_c = 200$  m/min,  $f_z = 0.15$  mm/tooth  
 Axial  $a_p$ : 5 mm, Radial  $a_e$ : 5 mm  
 Work Material : C50

### ● Anti-Rotational Mechanism

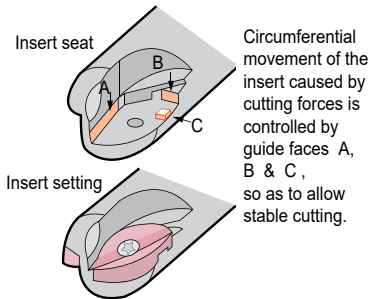

### ● Insert Life

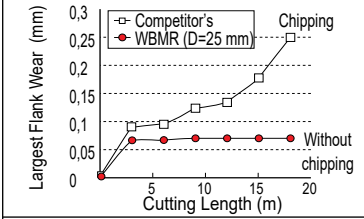

Cutting Conditions (Shoulder milling, downcut)  
 $v_c = 100$  m/min,  $f_z = 0.15$  mm/tooth  
 Axial  $a_p$ : 5 mm, Radial  $a_e$ : 5 mm  
 Work Material : X40CrMoV5-1(HRC45)

## ■ Application Example

### ● Cold Molding Die

Work Material :  
X 155 CrVMo 12 1

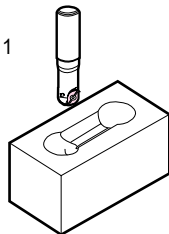

<Results>  
 Flank wear after continuous cutting for seven hours was less than other manufacturer's product. Stable cutting was observed.

WBMR 2200S ( $\phi 20$  mm)      Cutting Conditions :  
 Insert Grade : ACZ350       $n = 2200$  rpm,  $v_f = 500$  mm/min  
 Depth of Cut : 0,3-2 mm  
 Non-water soluble cutting oil

### ● Injection Molded Part (Cr-Mo steel + Stellite-overlay)

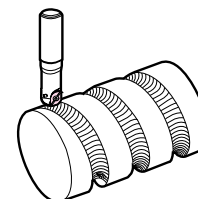

<Results>  
 Wave ball ( $\phi 30$ mm) could cut without chattering while other manufacturer's products could not cut at all due to chattering.

WBMR 2300M ( $\phi 30$  mm)      Cutting Conditions :  
 Insert Grade : ACZ350       $n = 500$  rpm,  $v_f = 35$  mm/min  
 Depth of Cut : 5 mm  
 Dry cut

## ■ Recommended Cutting Conditions (2 teeth)

Condition	Material	Carbon steel	Alloy steel	Stainless,	Cast iron
		(Below HRC25)	(Below HRC45)	Die steel etc.	
(A)	$v_c$	200-250-300	100-150-200	50-80-100	100-120-150
	$f_z$	0,1-0,2-0,3	0,1-0,2-0,3	0,1-0,15-0,2	0,2-0,3-0,4

[ $v_c =$  m/min,  $f_z =$  mm/tooth] [min. - optimum - max.]

## ■ Recommended Cutting Conditions (4 teeth)

Condition	Material	Carbon steel	Alloy steel	Stainless,	Cast iron
		(Below HRC25)	(Below HRC45)	Die steel etc.	
(A)	$v_c$	200-250-300	100-150-200	50-80-100	100-120-150
	$f_z$	0,1-0,2-0,3	0,1-0,2-0,3	0,1-0,15-0,2	0,2-0,3-0,4
(B)	$v_c$	160-200-240	80-120-160	40-60-80	80-100-120
	$f_z$	0,1-0,2-0,3	0,1-0,2-0,3	0,1-0,15-0,2	0,2-0,3-0,4

[ $v_c =$  m/min,  $f_z =$  mm/tooth] [min. - optimum - max.]

# "Wave Ball Mill" for Roughing WBMR 2000

# "Wave Ball Mill" for Roughing WBMR 2000 L

Rake Angle	Radial	-
	Axial	-10°

20-47mm

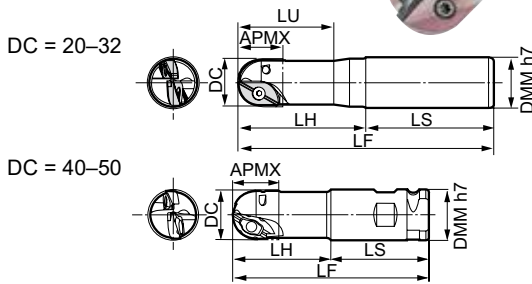

Rake Angle	Radial	-
	Axial	-10°

30-69mm

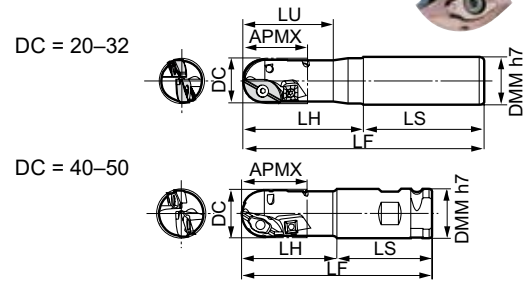

## Body (Short and middle length type, 2 teeth)

Cat. No.	Stock	Dimensions (mm)						
		DC	DMM	APMX	LH	LS	LU	LF
WBMR 2200 S	●	20	25	20	60	80	40	140
2200 M	●	20	25	20	60	140	40	200
2200 MW	●	20	25	20	60	140	40	200
WBMR 2250 S	●	25	32	23	70	80	50	150
2250 M	●	25	32	23	73	147	50	220
2250 MW	●	25	32	23	73	147	50	220
WBMR 2320 S	●	32	32	31	80	80	60	160
2320 M	●	32	32	31	85	155	60	240
2320 MW	●	32	32	31	85	155	60	240
WBMR 2400 S	○	40	42	35	100	100	-	200
2400 M	○	40	42	35	180	100	-	280
WBMR 2500 S	○	50	42	47	100	100	-	200
2500 M	○	50	42	47	180	100	-	280

- S: Short type with cylindrical shank
- M: Middle length type with cylindrical shank
- MW: Middle length type with Weldon shank

## Body (Extra long type, 4 teeth)

Cat. No.	Stock	Dimensions (mm)						
		DC	DMM	APMX	LH	LS	LU	LF
WBMR 2200 LL	●	20	25	30	80	170	40	250
2200 LLW	●	20	25	30	80	170	40	250
WBMR 2250 LL	○	25	32	38	100	200	50	300
2250 LLW	●	25	32	38	100	200	50	300
WBMR 2320 LL	●	32	32	44	120	230	60	350
2320 LLW	●	32	32	44	120	230	60	350
WBMR 2400 LL	○	40	42	50	250	100	-	350
2400 LLW	○	40	42	50	250	100	-	350
WBMR 2500 LL	○	50	42	69	250	100	-	350
2500 LLW	○	50	42	69	250	100	-	350

- LL: Extra long type with cylindrical shank
- LLW: Extra long type with Weldon shank

## Inserts

Application	Coated Carbide			Dimensions (mm)							Fig.	No. of teeth	Applicable Endmill
	ACP200	ACP300	ACK300	L	W1	S	RE						
High Speed / Light cut													
General Purpose	●	●	●										
Roughing	●	●	●	●									
Cat. No.	ACP200	ACP300	ACK300	L	W1	S	RE	Fig.	No. of teeth	Applicable Endmill			
ZNMT 1804100-C	●	●	●	18,00	9,76	4,76	10,0	1	1	WBMR 2200			
2004100-S	●	●	●	20,00	7,50	4,37	10,0	2	1				
SPMT 070308	○	○	○	7,94	-	3,18	-	3	2	WBMR 2250			
ZNMT 2205125-C	●	●	●	22,50	12,20	5,70	12,5	1	1				
2305125-S	●	●	●	23,00	9,38	5,56	12,5	2	1				
SPMT 09T308	●	●	●	9,53	-	3,97	-	3	2	WBMR 2320			
ZNMT 2907160-C	●	●	●	29,00	15,62	7,15	16,0	1	1				
3006160-S	●	●	●	30,00	12,00	6,70	16,0	2	1				
SPMT 09T308	●	●	●	9,53	-	3,97	-	3	2	WBMR 2400			
ZNMT 3608200	○	○	○	36,00	19,50	6,70	20,0	4	2				
SPMT 09T308	●	●	●	9,53	-	3,97	-	3	2	WBMR 2500			
ZNMT 4310250	○	○	○	43,00	25,70	10,15	25	4	2				
4310250-N	○	○	○	43,00	25,70	10,15	25	5	2				
SPMT 120408	○	○	○	12,7	-	4,76	-	3	2				

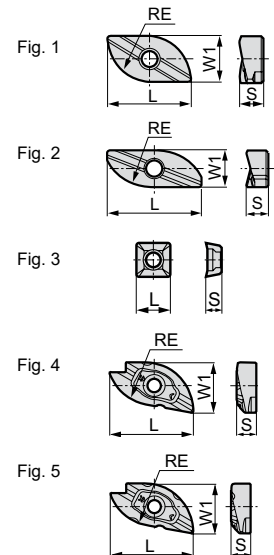

## Spare Parts

Screw	Wrench	Wrench	Applicable Endmill
BFTX 0307N	2,0	TRX10	WBMR 2200, WBMR 2200 LL
BFTX 0409N	3,4	-	WBMR 2250, WBMR 2250LL
BFTX 0511N	5,0	-	WBMR 2320, WBMR 2320LL
BFTX 0407N	3,0	-	WBMR 2320LL
BFTX0619N	7,5	-	WBMR 2400, WBMR 2500, WBMR 2400LL, WBMR 2500LL
BFTX 0409N	3,4	-	WBMR 2500LL

# "Wave Ball Mill" for Finishing WBMF Type



## ■ Features

The outstanding results obtained from this finishing cutter are due to the combination of its large sigmoid blade and precise clamping system making it extremely rigid !

The WBMF achieves an excellent machined finish greatly reducing hand finishing and polishing operations.

- Advantages
- Unique rigid clamping system
  - Large sigmoid blade
  - Smooth cutting action
  - High quality machined surface
  - Ultra hard ZX coated cutting edge

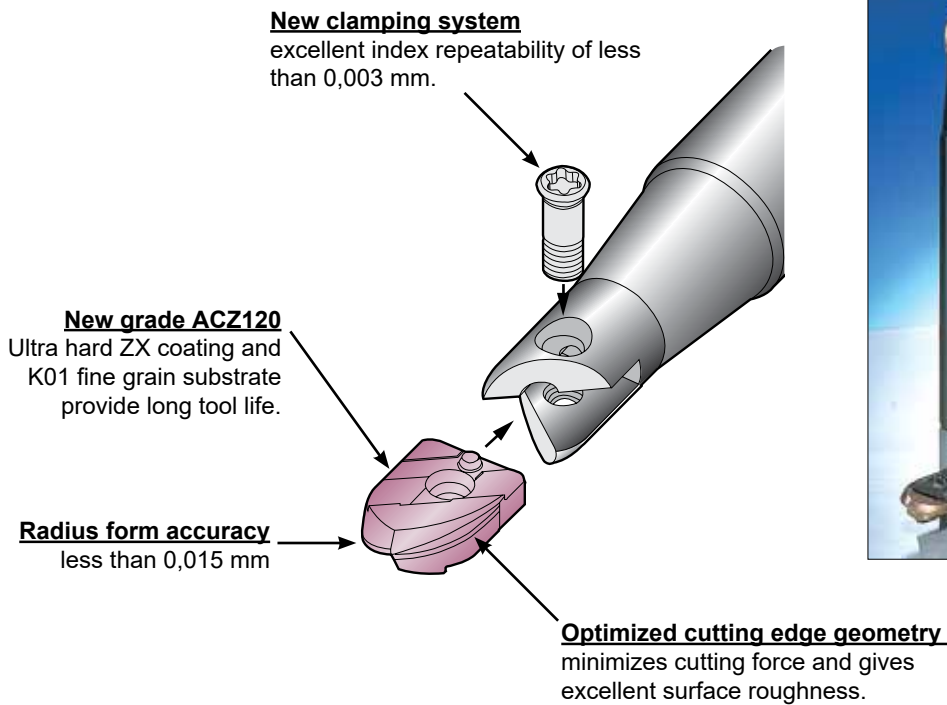

## ■ Application Example

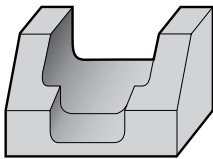
● Bumper Moulding Die	
Work Material : C55	
	
<Results> Surface roughness after continuous cutting for twelve hours was better than other manufacturer's product. Less width of flank wear was observed.	
WBMF1200M (ø20mm) Insert : ZPGU2471100 Grade : ACZ120	Cutting Conditions $v_c = 88$ m/min $v_f = 700$ mm/min ( $f_z = 0,25$ mm/tooth) Width of Cut : 0,5 mm Depth of Cut : 0,5 mm Dry

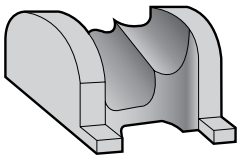
● Bumper Moulding Die	
Work Material : C50	
	
<Results> Smooth cutting and good surface finish after continuous cutting for eight hours	
WBMF1200M (ø20mm) Insert : ZPGU2471100 Grade : ACZ120	Cutting Conditions $v_c = 190$ m/min $v_f = 1200$ mm/min ( $f_z = 0,21$ mm/tooth) Width of Cut : 0,2 mm Depth of Cut : 0,2 mm Dry

● = Euro stock  
○ = Japan stock

 Recommended Tightening Torque (N·m)

# "Wave Ball Mill" for Finishing WBMF 1000

Rake Angle	Radial	-
	Axial	0°

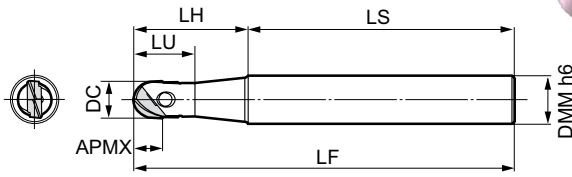

## ■ Body

Cat. No.	Stock	Dimensions (mm)							
		DC	DMM	APMX	LH	LS	LU	LF	
WBMF 1100 S	○	10	16	9	30	70	17	100	
1100 M	●	10	16	9	35	95	17	130	
1100 L	○	10	16	9	50	130	17	180	
WBMF 1120 S	○	12	16	10,5	40	70	19,5	110	
1120 M	●	12	16	10,5	40	110	19,5	150	
1120 MM12N	○	12	12	10,5	40	110	19,5	150	
1120 L	○	12	16	10,5	60	140	19,5	200	
WBMF 1160 S	○	16	20	12	50	80	25,5	130	
1160 M	●	16	20	12	50	130	25,5	180	
1160 MM12N	○	16	16	12	50	130	25,5	180	
1160 L	○	16	20	12	70	150	25,5	220	
WBMF 1200 S	○	20	25	15	60	80	32	140	
1200 M	●	20	25	15	60	140	32	200	
1200 MM20N	○	20	20	15	60	140	32	200	
1200 L	○	20	25	15	80	170	32	250	
WBMF 1250 S	○	25	32	18,5	70	80	36	150	
1250 M	●	25	32	18,5	73	147	36	220	
1250 L	○	25	32	18,5	100	200	36	300	
WBMF 1300 S	○	30	32	22,5	80	80	43	160	
1300 M	●	30	32	22,5	85	155	43	240	
1300 L	○	30	32	22,5	120	230	43	350	

S : Short type  
M : Middle length type  
L : Long type

## ■ Inserts

Application	Coated	Dimensions (mm)						Applicable Endmill
High Speed / Light cut	P	DC	L	APMX	S	RE		
General Purpose								
Roughing								
Cat. No.	ACZ120	DC	L	APMX	S	RE	Applicable Endmill	
ZPGU 1551050	●	10	15,6	9	5,1	5,0	WBMF1100	
ZPGU 1856060	●	12	18	10,5	5,6	6,0	WBMF1120	
ZPGU 2061080	●	16	20,5	12	6,1	8,0	WBMF1160	
ZPGU 2471100	●	20	24,5	15	7,1	10,0	WBMF1200	
ZPGU 2876125	●	25	28,5	18,5	7,6	12,5	WBMF1250	
ZPGU 3486150	●	30	34,4	22,5	8,6	15,0	WBMF1300	

## ■ Spare Parts

Screw	Wrench	Applicable Endmill
BFTG0408F 3,4	TRD15	WBMF1100
BFTG0409F 3,4	TRD15	WBMF1120
BFTG0513F 5,0	TRD20	WBMF1160
BFTG0617F 7,5	TRD25	WBMF1200
BFTG0621F 7,5	TRD25	WBMF1250
BFTG0825F 7,5	TRD25	WBMF1300

## ■ Recommended Cutting Conditions

ISO	Work Material	Hardness	Cutting Speed $v_c$ (m/min)	Feed Rate $f_z$ (mm/t)	Insert Grade
P	Carbon Steel	180-280 HB	200-250-300	0,10-0,20-0,30	ACZ210
	Alloy Steel	180-280 HB	100-150-200	0,10-0,20-0,30	ACZ210

Min.-Optimum-Max.

# "Wave Radius Mill" WRCX 08000/10000 E

Multi Purpose Endmills with Polygon Inserts

## Shank Type with Small Diameter Inserts

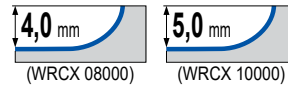

E<sub>-</sub> : Cylindrical straight shank type

ES : Short type with straight shank  
EM : Middle length type with straight shank  
EL : Long type with straight shank

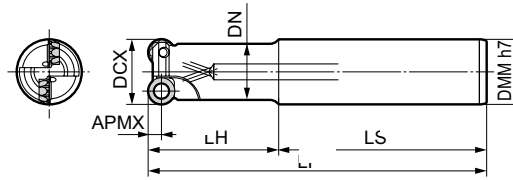

Axial rake angle: -3°  
Radial rake angle: 0 - 35°

### ■ BODY

Cat. No.	Stock	Dimensions (mm)							No. of teeth	Axial Rake	Radial Rake	Helical Boring øB Standard	Plunging α max.	Screwdriver	Torque (N·m)
		DCX	DMM	DN	APMX	LF	LH	LS							
WRCX 08012 ES	●	12	12	9,4	4	110	40	70	1	-3°	-35°	-	0°30'	BFTX 02505 IP	1,5
08012 EM	●	12	12	9,4	4	150	70	80	1	-3°	-10°	24 <sup>+7</sup> <sub>-4</sub>	5°30'		
WRCX 08016 ES	●	16	16	14	4	120	50	70	1	-3°	-10°	24 <sup>+7</sup> <sub>-4</sub>	5°30'		
08016 EM	●	16	16	14	4	150	70	80	1	-3°	-10°	24 <sup>+7</sup> <sub>-4</sub>	5°30'		
WRCX 08020 ES	●	20	20	18	4	130	50	80	2	-3°	-3°	32 <sup>±7</sup>	13°	BFTX 02506 IP	1,5
08020 EM	●	20	20	18	4	180	100	80	2	-3°	-3°	32 <sup>±7</sup>	13°		
08020 EL	●	20	20	18	4	250	130	120	2	-3°	-3°	32 <sup>±7</sup>	13°		
WRCX 08025 ES	●	25	25	21	4	130	50	80	3	-3°	0°	42 <sup>±7</sup>	8°20'		
08025 EM	●	25	25	21	4	180	100	80	3	-3°	0°	42 <sup>±7</sup>	8°20'		
08025 EL	●	25	25	21	4	250	130	120	3	-3°	0°	42 <sup>±7</sup>	8°20'		
WRCX 10025 ES	●	25	25	21	5	130	50	80	2	-3°	0°	40 <sup>±8</sup>	13°10'		
10025 EM	●	25	25	21	5	180	100	80	2	-3°	0°	40 <sup>±8</sup>	13°10'		
10025 EL	●	25	25	21	5	250	130	120	2	-3°	0°	40 <sup>±8</sup>	13°10'		
WRCX 10032 ES	●	32	32	28	5	130	50	80	3	-3°	0°	54 <sup>±8</sup>	8°	BFTX 03584 IP	3,0
10032 EM	●	32	32	28	5	200	120	80	3	-3°	0°	54 <sup>±8</sup>	8°		
10032 EL	●	32	32	28	5	300	180	120	3	-3°	0°	54 <sup>±8</sup>	8°		

### ■ Spare Parts

### ■ Inserts

Application	Coated Carbide					Uncoated Carbide	Diamond Coated	Dimensions (mm)			Fig.	Applicable Endmill
	P	M	K	N	H	DL1000	IC	RE	S			
High Speed / Light cut	●					●	●					
General Purpose		●	●	●								
Roughing		●	●		●							
Cat. No.	ACP100	ACP200	ACP300	ACK200	ACK300	H1	DL1000	IC	RE	S	Fig.	Applicable Endmill
QPMT 080330 PPEN		●	●	●	●			8	3,0	3,18	1	WRCX 08000 E
080330 PPEN-H		●	●	●	●			8	3,0	3,18	1	
QPMT 10T335 PPEN		●	●	●	●			10	3,5	3,97	1	WRCX 10000 E
10T335 PPEN-H		●	●	●	●			10	3,5	3,97	1	
QPET 10T350 PPFR-S						●	●	10	5,0	3,97	2	

Fig. 1

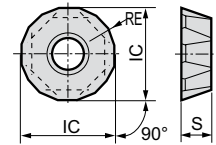
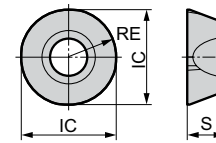

Fig. 2



QPMT... : Standard 16 cornered polygon type  
QPMT...-H: Stronger cutting edge type

QPET...-S: Polished round insert for non-ferrous material

### ■ Recommended Cutting Conditions

ISO	Work Material	Hardness	Cutting Speed v <sub>c</sub> (m/min)	Feed Rate f <sub>z</sub> (mm/t)	Insert Grade
P	Carbon Steel	180-280 HB	80-120-160	0,10-0,30-0,40	ACP200
	Alloy Steel	180-280 HB	60-100-140	0,10-0,20-0,30	ACP200
M	Stainless Steel	-	60-100-120	0,10-0,15-0,20	ACP300
K	Cast Iron	250 HB	60-80-120	0,10-0,20-0,30	ACK200
N	Non-ferrous Alloys	-	200-500-1.000	0,10-0,20-0,30	DL1000

Min.-Optimum-Max.



# Exchangeable Head Endmills WRCX 0800/10000/12000 M

## Modular Type

Rake Angle	Radial	-3° - 0°
	Axial	-3°

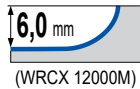
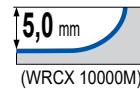
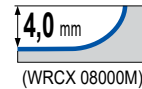

### Heads

For insert type : QPMT 0803

Cat. No.	Stock	Dimensions (mm)									No. of teeth
		DCX	DCON	CRKS	OAL	LF	LS2	LS	L11	H	
WRCX 08020M10Z2	●	20	10,5	M10	49	30	5	19	8	15	2
WRCX 08025M12Z3	●	25	12,5	M12	56	35	5	21	10	19	3

Inserts are not included.

### Heads

For insert type : QPOT 10T3

Cat. No.	Stock	Dimensions (mm)									No. of teeth
		DCX	DCON	CRKS	OAL	LF	LS2	LS	L11	H	
WRCX 10025M12Z2	●	25	12,5	M12	56	35	5	21	10	19	2
10028M12Z3	●	28	12,5	M12	56	35	5	21	10	19	2
WRCX 10030M16Z3	●	30	17,0	M16	63	40	5	23	10	24	3
10032M16Z3	●	32	17,0	M16	63	40	5	23	10	24	3

Inserts are not included.

### Identification Details

<b>WRCX</b>	<b>08</b>	<b>020</b>	<b>M10</b>	<b>Z2</b>
Cutter Type	Insert Size	Diameter	Mounting Screw	No. of Teeth

### Heads

For insert type : QPOT 1204

Cat. No.	Stock	Dimensions (mm)									No. of teeth
		DCX	DCON	CRKS	OAL	LF	LS2	LS	L11	H	
WRCX 12040M16Z4	○	40	17,0	M16	63	40	5	23	10	24	4

Inserts are not included.



### Inserts

Application		Coated Carbide					Uncoated carbide	Diamond Coated	QPMT... : 16 corner insert for general purpose application QPMT...-H: 16 corner insert with strong cutting edge QPET...-S: Round insert with sharp cutting edge for aluminium				
		P	M	K	N								
High Speed / Light cut		●					●						
General Purpose			●	●	●								
Roughing			●	●		●							
Cat. No.		ACP100	ACP200	ACP300	ACK200	ACK300	H1	DL1000	Dimensions (mm)			Fig.	Applicable Endmill
		IC	RE	S									
QPMT 080330 PPEN		●	●	●	●	●			8	3,0	3,18	1	WRCX 08000 M
080330 PPEN-H	●	●	●	●	●	●			8	3,0	3,18	1	
QPMT 10T335 PPEN		●	●	●	●	●			10	3,5	3,97	1	WRCX 10000 M
10T335 PPEN-H	●	●	●	●	●	●			10	3,5	3,97	1	
QPET 10T350 PFR-S							●	●	10	5,0	3,97	2	WRCX 12000 M
QPMT 120440 PPEN	●	●	●	●	●	●			12	4,0	4,76	1	
120440 PPEN-H	●	●	●	●	●	●			12	4,0	4,76	1	
QPET 120460 PFR-S							●	●	12	6,0	4,76	2	

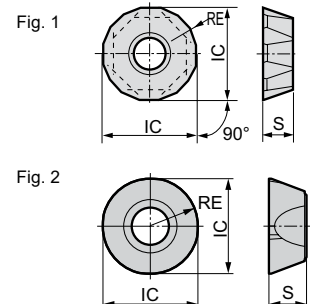

### Spare Parts

Screw	Wrench	Applicable Endmill	
BFTX 02506 IP	1,5	TRDR 08 IP	WRCX 08020M - WRCX 08025M

### Spare Parts

Screw	Wrench	Applicable Endmill	
BFTX 03584 IP	3,0	TRDR 15 IP	WRCX 10025M - WRCX 10032M
BFTX 0409 IP	3,0	TRDR 15 IP	WRCX 12040M

### Recommended Cutting Conditions

Diameter Ø20 - Ø32 mm

ISO	Work Material	Hardness	Cutting Speed $v_c$ (m/min)	Feed Rate $f_z$ (mm/t)	Insert Grade
P	Carbon Steel	180-280 HB	80-120-160	0,10-0,30-0,40	ACP200
P	Alloy Steel	180-280 HB	60-100-140	0,10-0,20-0,30	ACP200
M	Stainless Steel	-	60-100-120	0,10-0,15-0,20	ACP300
K	Cast Iron	250 HB	60-80-120	0,10-0,20-0,30	ACK200
N	Non-ferrous Alloys	-	200-500-1.000	0,10-0,20-0,30	DL1000

Min.-Optimum-Max.

Diameter Ø40 mm

ISO	Work Material	Hardness	Cutting Speed $v_c$ (m/min)	Feed Rate $f_z$ (mm/t)	Insert Grade
P	Carbon Steel	180-280 HB	100-160-200	0,20-0,40-0,60	ACP200
P	Alloy Steel	180-280 HB	100-140-180	0,20-0,30-0,40	ACP200
M	Stainless Steel	-	80-120-160	0,10-0,20-0,30	ACP300
K	Cast Iron	250 HB	80-120-160	0,10-0,20-0,40	ACK200
N	Non-ferrous Alloys	-	200-500-1.000	0,10-0,30-0,40	DL1000



Min.-Optimum-Max.



# "Wave Radius Mill" RSX(F)08000/10000/12000ES

Milling of steel, stainless steel, cast iron and exotic alloys

## Shank Type

Rake Angle	Radial	-5° - -8°			
	Axial	10°	(08000ES)	(10000ES)	(12000ES)

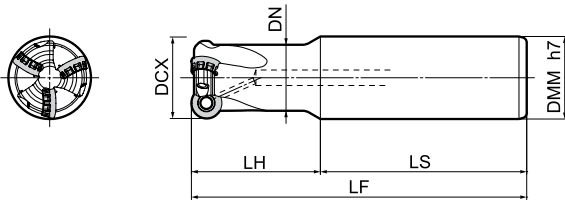

## Body (RSX...ES, Standard)

Cat. No.	Stock	Dimensions (mm)						No. of teeth	Weight (kg)
		DCX	DMM	DN	LH	LS	LF		
RSX 08020 ES	●	20	20	16,9	30	70	100	2	0,3
08025 ES	●	25	25	21,9	40	80	120	3	0,4
RSX 10025 ES	●	25	25	20,3	50	80	130	2	0,4
10032 ES	●	32	32	27,1	50	80	130	3	0,7
RSX 12032 ES	●	32	32	25,6	50	80	130	2	0,7

## Body (RSXF...ES, Fine Pitch)

Cat. No.	Stock	Dimensions (mm)						No. of teeth	Weight (kg)
		DCX	DMM	DN	LH	LS	LF		
RSXF08020 ES	●	20	20	16,9	30	70	100	3	0,3
08025 ES	●	25	25	21,9	40	80	120	4	0,4
RSXF 10025 ES	●	25	25	20,3	50	80	130	3	0,4
10032 ES	●	32	32	27,1	50	80	130	4	0,7
RSXF 12032 ES	●	32	32	25,6	50	80	130	3	0,7

## Inserts

Application	Grade					Dimens.		Applicable Cutters
	ACP200	ACK300	ACM100	ACM200	ACM300	IC	S	
High Speed/Light Cut			M S	M S				RSX(F) 08000ES
General Purpose	P M	M S	M S	M S				
Roughing	P M	K			M S			
Cat. No.	ACP200	ACK300	ACM100	ACM200	ACM300	IC	S	
RDET 0803M0EN G	●	●	●	●	●	8	3,18	RSX(F) 08000ES
0803M0EN H	○	●	●	●	●	8	3,18	
RDET 10T3M0EN G	●	●	●	●	●	10	3,97	RSX(F) 10000ES
10T3M0EN H	●	●	●	●	●	10	3,97	
RDET 1204M0EN G	●	●	●	●	●	12	4,76	RSX(F) 12000ES
1204M0EN H	●	●	●	●	●	12	4,76	

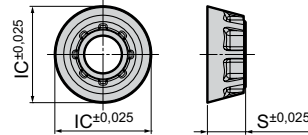



Cutting Edge Cross Section



M0: IC is metric

## Spare Parts

Applicable Cutters	Wrench	Screw	
			
RSX(F) 08000ES	TRDR08IP	BFTX02506IP	1,5
RSX(F) 10000ES	TRDR15IP	BFTX03584IP	3,0
RSX(F) 12000ES		BFTX0409IP	3,0

## Identification Details

<b>RSX</b>	<b>F</b>	<b>10</b>	<b>025</b>	<b>ES</b>
Cutter Series	Fine Pitch Type	Insert Size	Cutter Diameter	Endmill Type

## Recommended Cutting Conditions

Min.-Optimum-Max.

ISO	Work Material		Hardness (HB)	Cutting Speed $v_c$ (m/min)	Feed Rate $f_t$ (mm/t)	Grade	
P	Carbon Steel		180-280	100-160-200	0,20-0,40-0,60	ACP200	
	Alloy Steel		180-280	100-140-180	0,20-0,30-0,40	ACP200	
M	Stain- less Steel	Cr Based	Ferritic	200	150-180-200	0,15-0,25-0,35	ACM300
			Martensitic	200-330	80-120-180	0,15-0,25-0,35	ACM300
	Cr-Ni Based	Austenitic	200	150-180-200	0,15-0,25-0,35	ACM300	
		Austenitic, ferritic	230-270	80-120-180	0,15-0,25-0,35	ACM200	
		Precipitation hardening	330	60-100-160	0,15-0,25-0,35	ACM200	
K	Cast Iron		250	80-120-160	0,10-0,30-0,40	ACK300	
S	Heat resistant alloy		Ni based material	250-350	20-30-40	0,10-0,20-0,30	ACM100 ACM200
	Titanium	Pure Titanium	(Rm400)	60-80-100	0,10-0,20-0,30		
		$\alpha + \beta$ alloy system	(Rm1050)	40-50-60	0,10-0,20-0,30		



● = Euro stock  
○ = Japan stock

→ G20/G21

 Recommended Tightening Torque (N·m)

# Exchangeable Head Endmills RSX(F)08000/10000/12000 M

## Modular Type

Rake Angle	Radial	-5° - -8°			
	Axial	10°	(08000ES)	(10000ES)	(12000ES)

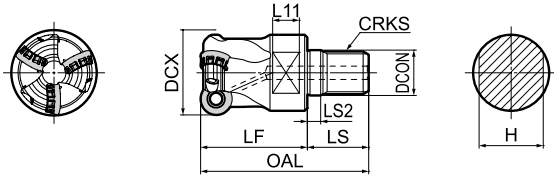

## Body (RSX...M, Standard)

Cat. No.	Stock	Dimensions (mm)								No. of Teeth	Weight (kg)	
		DCX	DCON	CRKS	OAL	LF	LS2	LS	L11			H
RSX 08020M10Z2	●	20	10,5	M10	49	30	5	19	8	15	2	0,1
08025M12Z3	○	25	12,5	M12	56	35	5	21	10	19	3	0,1
08032M16Z4	○	32	17,0	M16	63	40	5	23	10	24	4	0,2
RSX 10025M12Z2	○	25	12,5	M12	56	35	5	21	10	19	2	0,1
10032M16Z3	●	32	17,0	M16	63	40	5	23	10	24	3	0,2
RSX 12032M16Z2	○	32	17,0	M16	63	40	5	23	10	24	2	0,2
12040M16Z3	●	40	17,0	M16	63	40	5	23	10	24	3	0,3



## Body (RSXF...M, Fine Pitch)

Cat. No.	Stock	Dimensions (mm)								No. of Teeth	Weight (kg)	
		DCX	DCON	CRKS	OAL	LF	LS2	LS	L11			H
RSXF 08020M10Z3	○	20	10,5	M10	49	30	5	19	8	15	3	0,1
08025M12Z4	●	25	12,5	M12	56	35	5	21	10	19	4	0,1
08032M16Z5	●	32	17,0	M16	63	40	5	23	10	24	5	0,2
RSXF 10025M12Z3	●	25	12,5	M12	56	35	5	21	10	19	3	0,1
10032M16Z4	●	32	17,0	M16	63	40	5	23	10	24	4	0,2
RSXF 12032M16Z3	●	32	17,0	M16	63	40	5	23	10	24	3	0,2
12040M16Z4	●	40	17,0	M16	63	40	5	23	10	24	4	0,3

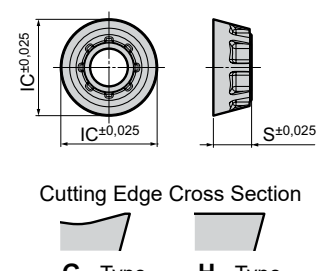
## Inserts

Application	Grade					Dimens.		Applicable Cutters
	ACP200	ACK300	ACM100	ACM200	ACM300	IC	S	
High Speed/Light Cut			M S	M S				 <p>Cutting Edge Cross Section G - Type      H - Type</p>
General Purpose	P M		M S	M S	M S			
Roughing	P M	K			M S			
Cat. No.								
RDET 0803M0EN G	●	●	●	●	●	8	3,18	RSX(F) 08000ES
0803M0EN H	○	●	●	●	●	8	3,18	
RDET 10T3M0EN G	●	●	●	●	●	10	3,97	RSX(F) 10000ES
10T3M0EN H	●	●	●	●	●	10	3,97	
RDET 1204M0EN G	●	●	●	●	●	12	4,76	RSX(F) 12000ES
1204M0EN H	●	●	●	●	●	12	4,76	

## Spare Parts

Applicable Cutters	Wrench	Screw	
			
RSX(F) 08000M	TRDR08IP	BFTX02506IP	1,5
RSX(F) 10000M	TRDR15IP	BFTX03584IP	3,0
RSX(F) 12000M		BFTX0409IP	3,0

## Identification Details

<b>RSX</b>	<b>F</b>	<b>10</b>	<b>025</b>	<b>M12</b>	<b>Z3</b>
Cutter Series	Fine Pitch Type	Insert Size	Cutter Diameter	Mounting Screw Size	No. of Teeth

## Recommended Cutting Conditions

Min.-Optimum-Max.

ISO	Work Material		Hardness (HB)	Cutting Speed v <sub>c</sub> (m/min)	Feed Rate f <sub>t</sub> (mm/t)	Grade	
P	Carbon Steel		180-280	100-160-200	0,20-0,40-0,60	ACP200	
	Alloy Steel		180-280	100-140-180	0,20-0,30-0,40	ACP200	
M	Stain-less Steel	Cr Based	Ferritic	200	150-180-200	0,15-0,25-0,35	ACM300
			Martensitic	200-330	80-120-180	0,15-0,25-0,35	ACM300
	Cr-Ni Based	Austenitic	200	150-180-200	0,15-0,25-0,35	ACM300	
		Austenitic, ferritic	230-270	80-120-180	0,15-0,25-0,35	ACM200	
		Precipitation hardening	330	60-100-160	0,15-0,25-0,35	ACM200	
K	Cast Iron		250	80-120-160	0,10-0,30-0,40	ACK300	
S	Heat resistant alloy		Ni based material	250-350	20-30-40	0,10-0,20-0,30	ACM100 ACM200
	Titanium		Pure Titanium	(Rm 400)	60-80-100	0,10-0,20-0,30	
			α + β alloy system	(Rm 1050)	40-50-60	0,10-0,20-0,30	

# "Wave Mill" Series

## WFXC Type

Expansion



### General Features

The WaveMill WFXC type is a chamfering tool that uses inserts for the WFX series. This allows the WFXC type to support many types of work materials using a variety of grades.

### Application Notes

Since chamfering uses the straight cutting edge portion of the insert, the range that can be chamfered will change depending on the corner radius (RE) of the insert that is attached to the body.

Work diameter: Use in a range greater or equal to DC1 and less than or equal to DC2.

Depth: The workpiece can be chamfered from „a“, which is the distance from the tip of the tool to the straight cutting edge at the depth indicated by „b“.

Body	Insert		Min. Work Diameter		Max. Work Diameter		Min. Depth		Max. Depth		Max. Diameter
	Cat. No.	RE	DC1	DC2	a	b	DCX				
WFXC 08008E	SOMT 080304	0,4	7,5	15,8	0,1	4,1	17,8				
	SOMT 080308	0,8	8,0	15,8	0,2	3,9	17,5				
	SOMT 080312	1,2	8,5	15,8	0,4	3,6	17,2				
WFXC 08016E	SOMT 080304	0,4	15,5	23,8	0,1	4,1	25,8				
	SOMT 080308	0,8	16,0	23,8	0,2	3,9	25,5				
	SOMT 080312	1,2	16,5	23,8	0,3	3,6	25,2				
WFXC 12025E	SOMT 120404	0,4	24,6	38,3	0,1	6,8	41,3				
	SOMT 120408	0,8	25,0	38,3	0,2	6,6	41,0				
	SOMT 120412	1,2	25,6	38,3	0,4	6,3	40,7				
	SOMT 120416	1,6	26,1	38,3	0,5	6,1	40,4				
WFXC 12032E	SOMT 120404	0,4	31,6	45,3	0,1	6,8	48,3				
	SOMT 120408	0,8	32,0	45,3	0,2	6,6	48,0				
	SOMT 120412	1,2	32,6	45,3	0,4	6,3	47,7				
	SOMT 120416	1,6	33,1	45,3	0,5	6,1	47,4				

Dimensions (mm)

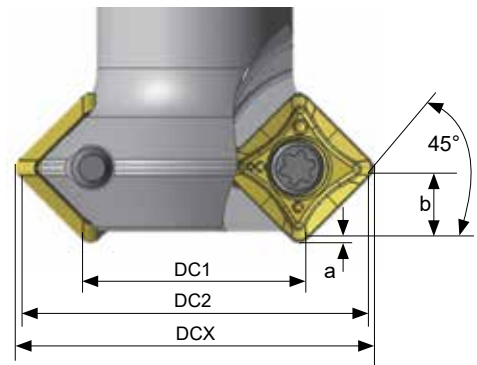

→ G26/G27

Indexable Endmills

# "Wave Mill" Series WFXC 08000/12000 E

Expansion



Rake Angle	Radial	0°
	Axial	0°

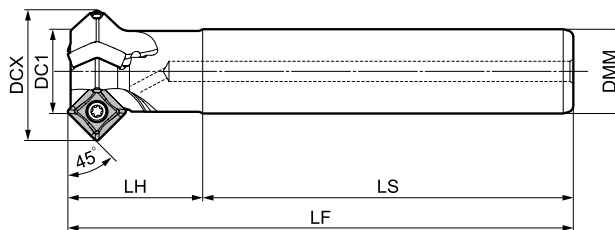

## Body WFXC 08000E (Standard Type)

Cat. No.	Stock	Dimensions (mm)						No. of Teeth	Weight (kg)
		DC1	DCX	LF	LH	LS	DMM		
WFXC 08008E	○	8	17,5	120	30	90	10	1	0,1
08016E	○	16	25,5	120	30	90	16	2	0,2

## Body WFXC 12000E (Standard Type)

Cat. No.	Stock	Dimensions (mm)						No. of Teeth	Weight (kg)
		DC1	DCX	LF	LH	LS	DMM		
WFXC 12025E	○	25	41,0	150	40	110	25	3	0,6
12032E	○	32	48,0	150	40	110	32	3	1,0

## Identification Details

<b>WFX</b>	<b>C</b>	<b>08</b>	<b>016</b>	<b>E</b>
Cutter Series	Chamfering	Insert Size	Cutter Diameter	Endmill Type

## Inserts

Application	Coated Carbide										Carbide DLC		RE	Fig.	Applicable Cutters
	K	P	M	M	K	K	M	M	H1	DL1000					
High Speed / Light cut	●	○	○	○	○	○	○	○	○	○	○	○	○	○	
General Purpose	●	○	○	○	○	○	○	○	○	○	○	○	○	○	
Roughing	●	○	○	○	○	○	○	○	○	○	○	○	○	○	
Cat. No.	ACU2500	XCU2500	ACP100	ACP200	ACP300	XCK2000	ACK200	ACK300	ACM200	ACM300	H1	DL1000	RE	Fig.	Applicable Cutters
SOMT 080304 PZER L	●	○	○	○	○	○	○	○	○	○	○	○	0,4	1	WFXC08000E
080308 PZER L	●	○	○	○	○	○	○	○	○	○	○	○	0,8	1	
SOMT 080304 PZER G	●	○	○	○	○	○	○	○	○	○	○	○	0,4	1	
080308 PZER G	●	○	○	○	○	○	○	○	○	○	○	○	0,8	1	
080312 PZER G	●	○	○	○	○	○	○	○	○	○	○	○	1,2	1	
SOMT 080308 PZER H	●	○	○	○	○	○	○	○	○	○	○	○	0,8	1	
080312 PZER H	●	○	○	○	○	○	○	○	○	○	○	○	1,2	1	
SOET 080304 PZER G	●	○	○	○	○	○	○	○	○	○	○	○	0,4	1	
080308 PZER G	●	○	○	○	○	○	○	○	○	○	○	○	0,8	1	
080312 PZER G	●	○	○	○	○	○	○	○	○	○	○	○	1,2	1	
SOET 080302 PZFR S	-	-	-	-	-	-	-	-	-	-	●	●	0,2	1	WFXC12000E
080304 PZFR S	-	-	-	-	-	-	-	-	-	-	●	●	0,4	1	
080308 PZFR S	-	-	-	-	-	-	-	-	-	-	●	●	0,8	1	
SOMT 120408 PDER L	●	○	○	○	○	○	○	○	○	○	○	○	0,8	2	
SOMT 120404 PDER G	●	○	○	○	○	○	○	○	○	○	○	○	0,4	2	
120408 PDER G	●	○	○	○	○	○	○	○	○	○	○	○	0,8	2	
120412 PDER G	●	○	○	○	○	○	○	○	○	○	○	○	1,2	2	
120416 PDER G	●	○	○	○	○	○	○	○	○	○	○	○	1,6	2	
SOMT 120408 PDER H	●	○	○	○	○	○	○	○	○	○	○	○	0,8	2	
SOET 120408 PDFR S	-	-	-	-	-	-	-	-	-	-	●	●	0,8	2	

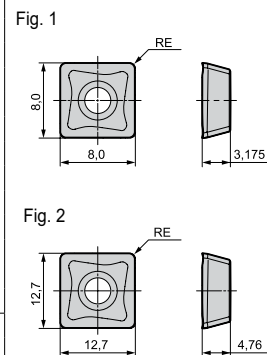

## Spare Parts

Applicable Cutter	Screw		Wrench
	WFXC08000E	BFTX0306IP	2,0
WFXC12000E	BFTX03512IP	3,0	TRDR15IP

## Recommended Cutting Conditions

ISO	Work Material	Hardness (HB)	Cutting Speed	Feed Rate
P	General Steel	180-280	150-200-250	0,05-0,10-0,15
	Soft Steel	≤180	180-265-350	0,10-0,15-0,20
	Die Steel	200-220	100-150-200	0,05-0,10-0,15
M	Stainless Steel	-	150-200-250	0,05-0,10-0,15
K	Cast Iron	250	100-175-250	0,05-0,10-0,15

Min. - Optimum - Max.

# "Wave Mill" Series

## WFXC 08000/12000 M

Expansion

### Modular Type

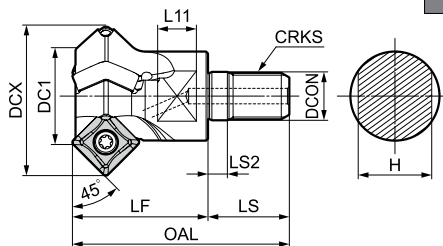

Rake Angle	Radial	0°
	Axial	0°



### Head (WFXC 08000M)

Cat. No.	Stock	Dimensions (mm)										No. of Teeth	Weight (kg)
		DC1	DCX	DCON	CRKS	OAL	LF	LS2	LS	L11	H		
WFXC08016M08Z2	○	16	25,5	8,5	M8	42	25	5	17	8	13	2	0,1

### Identification Details

<b>WFX</b>	<b>C</b>	<b>08</b>	<b>016</b>	<b>M08</b>	<b>Z2</b>
Cutter Series	Chamfering	Insert Size	Cutter Diameter	Screw Size	No. of Teeth

### Head (WFXC 12000M)

Cat. No.	Stock	Dimensions (mm)										No. of Teeth	Weight (kg)
		DC1	DCX	DCON	CRKS	OAL	LF	LS2	LS	L11	H		
WFXC12025M12Z3	○	25	41,0	12,5	M12	56	32	5	21	10	19	3	0,1
12032M16Z3	○	32	48,0	17,0	M16	63	40	5	23	10	24	3	0,2

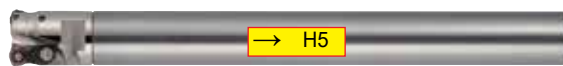

### Inserts

Application	Coated Carbide										Carbide		DLC		RE	Fig.	Applicable Cutters
	K	P	M	P	M	K	K	M	M	K	N	N					
High Speed / Light cut	●	●	●	●	●	●	●	●	●	●	●	●	●	●	●	●	
General Purpose	●	●	●	●	●	●	●	●	●	●	●	●	●	●	●	●	
Roughing	●	●	●	●	●	●	●	●	●	●	●	●	●	●	●	●	
Cat. No.	ACU2500	XCU2500	ACP100	ACP200	ACP300	XCK2000	ACK200	ACK300	ACM200	ACM300	H1	DL1000	RE	Fig.	Applicable Cutters		
SOMT 080304 PZER L	●	○	●	●	○	○	○	●	●	●	●	●	0,4	1	WFXC08000E		
SOMT 080308 PZER L	●	○	●	●	○	○	○	●	●	●	●	●	0,8	1			
SOMT 080304 PZER G	●	○	●	●	○	○	○	●	●	●	●	●	0,4	1			
SOMT 080308 PZER G	●	○	●	●	○	○	○	●	●	●	●	●	0,8	1			
SOMT 080312 PZER G	●	○	●	●	○	○	○	●	●	●	●	●	1,2	1			
SOMT 080308 PZER H	●	○	●	●	○	○	○	●	●	●	●	●	0,8	1			
SOMT 080312 PZER H	●	○	●	●	○	○	○	●	●	●	●	●	1,2	1			
SOET 080304 PZER G	●	○	○	○	○	○	○	○	○	○	○	○	0,4	1			
SOET 080308 PZER G	●	○	○	○	○	○	○	○	○	○	○	○	0,8	1			
SOET 080312 PZER G	●	○	○	○	○	○	○	○	○	○	○	○	1,2	1			
SOET 080302 PZFR S	-	-	-	-	-	-	-	-	-	-	●	●	0,2	1			
SOET 080304 PZFR S	-	-	-	-	-	-	-	-	-	-	●	●	0,4	1			
SOET 080308 PZFR S	-	-	-	-	-	-	-	-	-	-	●	●	0,8	1			
SOMT 120408 PDER L	●	○	●	●	○	○	○	●	●	●	●	●	0,8	2	WFXC12000E		
SOMT 120404 PDER G	●	○	○	●	●	○	○	●	●	●	●	●	0,4	2			
SOMT 120408 PDER G	●	○	○	●	●	○	○	●	●	●	●	●	0,8	2			
SOMT 120412 PDER G	●	○	○	●	●	○	○	●	●	●	●	●	1,2	2			
SOMT 120416 PDER G	●	○	○	●	●	○	○	●	●	●	●	●	1,6	2			
SOMT 120408 PDER H	●	○	●	●	●	○	○	●	●	●	●	●	0,8	2			
SOET 120408 PDER S	●	○	-	-	-	-	-	-	-	-	●	●	0,8	2			

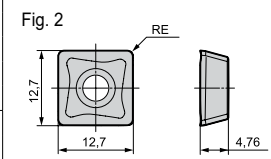
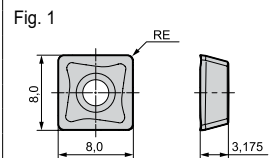

### Spare Parts

Applicable Cutter	Screw		Wrench
	WFXC08000M	BFTX0306IP	2,0
WFXC12000M	BFTX03512IP	3,0	TRDR15IP

### Recommended Cutting Conditions

ISO	Work Material	Hardness (HB)	Cutting Speed	Feed Rate
P	General Steel	180-280	150-200-250	0,05-0,10-0,15
	Soft Steel	≤180	180-265-350	0,10-0,15-0,20
M	Die Steel	200-220	100-150-200	0,05-0,10-0,15
M	Stainless Steel	-	150-200-250	0,05-0,10-0,15
K	Cast Iron	250HB	100-175-250	0,05-0,10-0,15

Min. - Optimum - Max.





# Alnex ANX Series

Expansion



## ■ Features

- **Drastically Reduced Runout Adjustment Time**  
Simple screw-fastening structure enables fine adjustments to be made easily.
- **Blade Through Coolant**  
Secures a supply of coolant to the cutting edge and breaks chips thoroughly.
- **Lightweight Aluminum Alloy Body**  
Utilizing aluminum alloy to achieve a total weight of less than 1,3 kg for a Ø 125 mm cutter with 22 teeth.

## ■ Product Range

Type	Cat. No.	Body Material	Diameter Range (mm) / No of Teeth										
			Ø 25	Ø 30	Ø 32	Ø 40	Ø 50	Ø 63	Ø 80	Ø 100	Ø 125	Ø 160	
Shell	ANXA 16000RS	Aluminum Alloy								6, 10, 14	8, 12, 18	10, 14, 22	12, 20, 28
	ANXA 16000R (Inch)	Aluminum Alloy								6, 10, 14	8, 12, 18	10, 14, 22	12, 20, 28
	ANXS 16000RS	Steel				4, 6	4, 6, 9	6, 8, 12	6, 10, 14	8, 12, 18	10, 14, 22		
	ANXS 16000R (Inch)	Steel						6, 8, 12	6, 10, 14	8, 12, 18	10, 14, 22		
Shank	ANXS 16000E	Steel	2	3, 4	3, 4	4, 6	4, 6, 9						
Modular	ANXS 16000M	Steel	2	3, 4	3, 4	4, 6							

→ M58-M69

Inch Bore

## ■ Blade Selection Guide

Work Material	N								
Applications	Finishing / Light Cutting	General Purpose	Roughing		Combined Milling *1	Corner Radius Milling	Corner Radius Milling	Finishing	Burr-free / Mirror Finishing
Features	Low Cutting Force	Standard	Long Edge	High Strength	High Strength	Corner Radius 0,4	Corner Radius 0,8	Wiper	Wiper
Type	L	G	GX	H	GB	-	-	W	WS
Cutting Edge Shape									
Edge Length(*2)	6,0 mm	6,0 mm	9,0 mm	6,0 mm	6,0 mm	6,0 mm	6,0 mm	2,0 mm	—

\*1 Machining of components combining aluminum alloy and cast iron

## ■ Edge Selection Guide

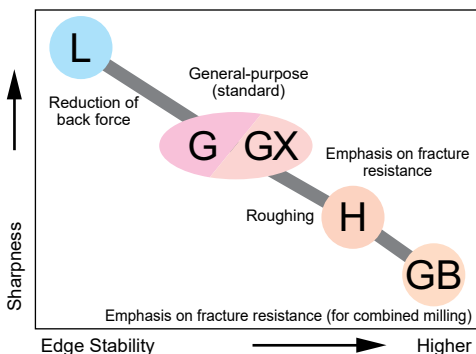

\*2 Edge length  
GX type = 9,0 mm

- **Reduces Running Costs by Drastically Increasing Blade, Insert Regrinding Allowance (to 1,0 mm)**

Assuming 0,2 mm of regrinding each time, an edge can be used up to 6 times. (Peripheral edge cannot be reground.)

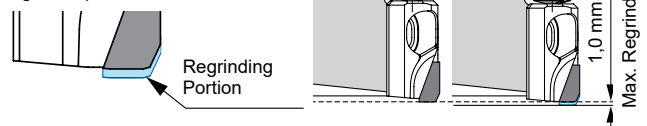

If you wish to use reground blades you shall use sets of blades with matching size of the same level in order to keep the balance.

## ■ Performances

### ● High-Speed / High-Efficiency Cutting

Realizes ultra-high efficiency machining with  $v_f = 30.000$  mm/min



Comparison: Cutter Diameter  $\varnothing$  100 mm

	Spindle Speed min <sup>-1</sup>	Number of Teeth	Feed Rate $v_f$ (mm/min)
ANX Series	18.000	18	32.400
Competitor	9.500	12	11.400

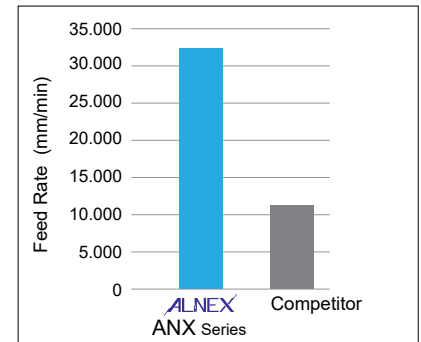

### ● Drastically Reduces Runout Adjustment Time

- Simple screw-fastening structure
- Enables fine adjustments to be made easily
- High-rigidity body

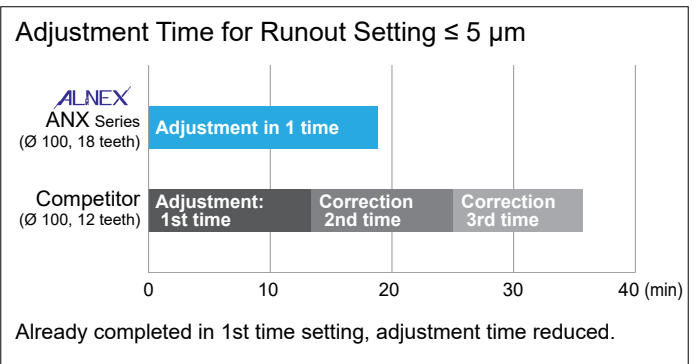
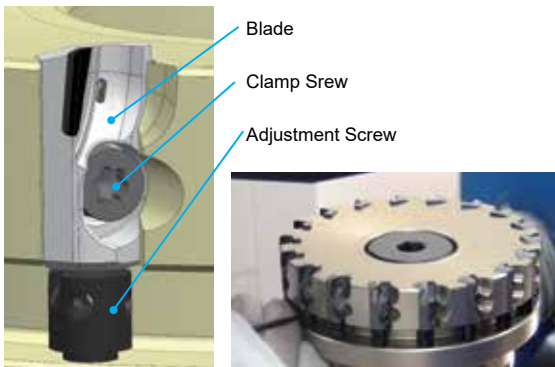

### ● Chip Control

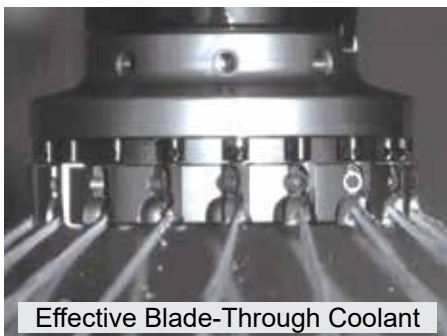

### Blade-Through Coolant Chip Breaking

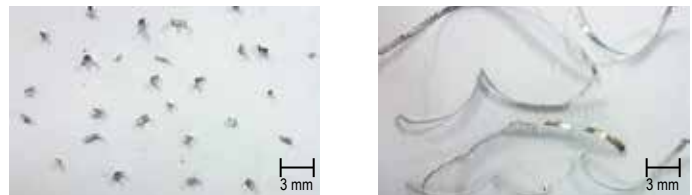

ALNEX ANX Series

Competitor

Work Material: G-AlSi12Cu  
Cutting Conditions:  $v_c = 2500$  m/min,  $f_z = 0,05$  mm/t,  $a_p = 0,5$  mm, wet

## ■ Adjustment of the Blades, Runout Alignment

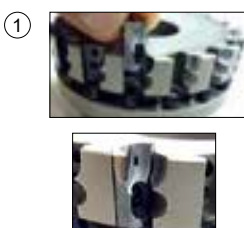

Insert the blade into its seat.

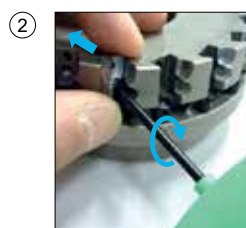

While holding the blade against the seat, install the clamping bolt using the provided wrench, pre-tightening the bolt. (recommended pre-torque is 1 N·m)

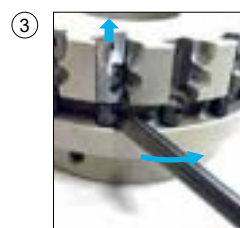

Using the provided wrench for the height adjustment screw, set the height to your predetermined value.



Fully tighten the clamp bolt. (recommended torque is 2 N·m)

# Alnex ANXS 16000 E

Expansion

Rake Angle	Radial	-2 – 0°	3 mm	90°
	Axial	+5°		

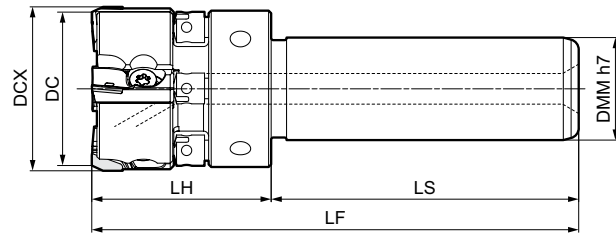

## ■ Body - ANXS (Steel)

Dimensions (mm)

Cat. No.	Stock	DC	DCX	DMM	LH	LS	LF	No. of Teeth	Weight (kg)
ANXS 16025E02	●	23	25	20	35	60	95	2	0,2
16030E03	●	28	30	20	35	60	95	3	0,3
16030E04	●	28	30	20	35	60	95	4	0,3
16032E03	●	30	32	20	35	60	95	3	0,3
16032E04	●	30	32	20	35	60	95	4	0,3
16040E04	●	38	40	20	40	60	100	4	0,4
16040E06	●	38	40	20	40	60	100	6	0,5
16050E04	○	48	50	32	40	80	120	4	1,0
16050E06	●	48	50	32	40	80	120	6	1,0
16050E09	●	48	50	32	40	80	120	9	1,0

Blades are sold separately. If using a blade for corner radius machining (ANB1604R/ANB1608R), DC = DCX.  
The weight includes the weight of the blade and parts.

## ■ Identification Details

<b>ANX</b>	<b>S</b>	<b>16</b>	<b>032</b>	<b>E</b>	<b>04</b>
Cutter Series	Steel Body	Blade Size	Cutter Diameter	Round Shank	Number of Teeth



## Blades

Dimensions (mm)

Application	SUMIDIA	CVD						
High Speed / Light Cut	N	N	→ M60-M61					
General Purpose	N	N						
Roughing	N	N						
Cat. No.	DA1000	DA90	SCV10	Cutting Edge Length	RE	Wiper Edge Shape	Applications	Fig.
ANB 1600R-L	●	—	—	6,0	—	Linear	Low Cutting Force	1
1600R-G	●	—	—	6,0	—	Arc-Shaped	General Purpose	1
1600R-GB	—	●	—	6,0	—	Arc-Shaped	Combined Milling*	1
1600R-H	●	—	—	6,0	—	Arc-Shaped	Strong Edge	1
1600R-GX	○	—	—	9,0	—	Arc-Shaped	Long Edge	2
1604R	○	—	—	6,0	0,4	Linear	Corner Radius	3
1608R	○	—	—	6,0	0,8	Linear	Corner Radius	3
1600R-W	○	—	—	2,0	—	Arc-Shaped	Wiper	4
1600R-WS	—	—	□	—	—	Arc-Shaped	Wiper	5

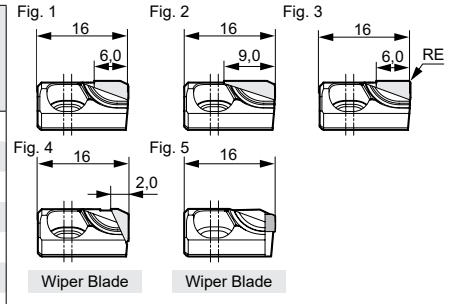

\* Cast Iron/Aluminum Alloy

## Recommended Cutting Conditions

Si content ≤ 12,6 %

Min. - Optimum - Max.

ISO	Work Material	Hardness	Cutting Speed $v_c$ (m/min)	Feed Rate $f_z$ (mm/t)	Grade
N	Aluminum Alloy	—	2.000–2.500–3.000	0,05–0,13–0,20	DA1000

Si content > 12,6 %

Min. - Optimum - Max.

ISO	Work Material	Hardness	Cutting Speed $v_c$ (m/min)	Feed Rate $f_z$ (mm/t)	Grade
N	Aluminum Alloy	—	400–600–800	0,05–0,13–0,20	DA1000 DA90

Combined Milling of Cast Iron/Aluminum Alloy

Min. - Optimum - Max.

ISO	Work Material	Hardness	Cutting Speed $v_c$ (m/min)	Feed Rate $f_z$ (mm/t)	Grade
K N	Cast Iron/ Aluminum Alloy	—	300–400–500	0,05–0,13–0,20	DA90

The above recommended cutting conditions are meant as a guide. Actual conditions will depend on the individual machine rigidity, work clamp rigidity, depth of cut and other factors.

## Max. Allowable Spindle Speed

Cat. No.	n max (min <sup>-1</sup> )
ANXS 16025E02	10.000
16030E03	10.000
16030E04	10.000
16032E03	10.000
16032E04	10.000
16040E04	10.000
16040E06	10.000
16050E04	10.000
16050E06	10.000
16050E09	10.000

## Spare Parts

Sold separately.

Applicable Cutters	Clamp Screw		Adjustment Screw	Wrench	Adjustment Wrench	Assembly Wrench
ANXS 160__E__	BXA0310IP	2,0	HFJ	TRXW10IP	ANT	HFVT

The adjustment spanner (ANT) can also be used for height adjustment of the RF type cutters for high speed machining and the HF type cutters for high efficiency machining.

### Wiper Blade Step Amount

When using the wiper blade, in order to maintain balance, be sure to use a cutter with an even number of cutting edges and place the wiper blades at opposite positions.

# Alnex ANXS 16000 M

**New**

Modular Type

Rake Angle	Radial	-2 - 0°	3 mm	90°
	Axial	+5°		

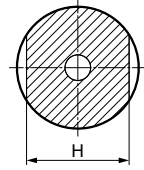
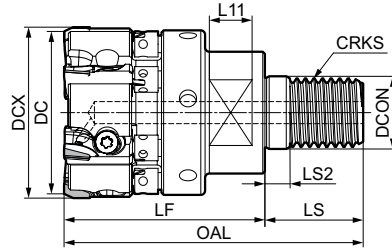
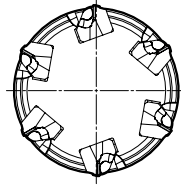

## Body - ANXS (Steel)

Dimensions (mm)

Cat. No.	Stock	DC	DCX	DCON	CRKS	OAL	LF	LS2	LS	L11	H	No. of Teeth	Weight (kg)
ANXS 16025M12Z02	○	23	25	12,5	<b>M12</b>	61	40	5	21	10	19	2	0,1
16030M16Z03	○	28	30	17,0	<b>M16</b>	70	47	5	23	10	24	3	0,2
16030M16Z04	○	28	30	17,0	<b>M16</b>	70	47	5	23	10	24	4	0,2
16032M16Z03	○	30	32	17,0	<b>M16</b>	70	47	5	23	10	24	3	0,3
16032M16Z04	○	30	32	17,0	<b>M16</b>	70	47	5	23	10	24	4	0,3
16040M16Z04	○	38	40	17,0	<b>M16</b>	70	47	5	23	10	24	4	0,4
16040M16Z06	○	38	40	17,0	<b>M16</b>	70	47	5	23	10	24	6	0,4

Blades are sold separately. If using a blade for corner radius machining (ANB1604R/ANB1608R), DC = DCX.  
The weight includes the weight of the blade and parts.

## Identification Details

<b>ANX</b>	<b>S</b>	<b>16</b>	<b>032</b>	<b>M16</b>	<b>Z03</b>
Cutter Series	Steel Body	Blade Size	Cutter Diameter	Screw size	Number of Blades

## Blades

Dimensions (mm)

Application	SUMIDIA	CVD						
High Speed / Light Cut	<b>N</b>	<b>N</b>	→ M60-M61					
General Purpose	<b>N</b>	<b>N</b>						
Roughing	<b>N</b>	<b>N</b>						
Cat. No.	DA1000	DA90	SCV10	Cutting Edge Length	RE	Wiper Edge Shape	Applications	Fig.
ANB 1600R-L	●	—	—	6,0	—	Linear	Low Cutting Force	1
1600R-G	●	—	—	6,0	—	Arc-Shaped	General Purpose	1
1600R-GB	—	●	—	6,0	—	Arc-Shaped	Combined Milling*	1
1600R-H	●	—	—	6,0	—	Arc-Shaped	Strong Edge	1
1600R-GX	○	—	—	9,0	—	Arc-Shaped	Long Edge	2
1604R	○	—	—	6,0	0,4	Linear	Corner Radius	3
1608R	○	—	—	6,0	0,8	Linear	Corner Radius	3
1600R-W	○	—	—	2,0	—	Arc-Shaped	Wiper	4
1600R-WS	—	—	□	—	—	Arc-Shaped	Wiper	5

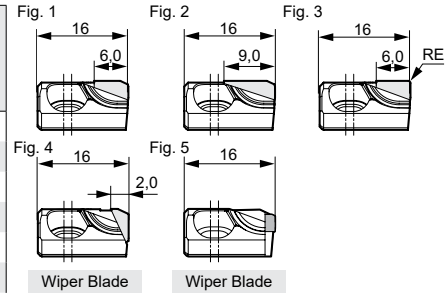

\* Cast Iron/Aluminum Alloy

## Recommended Cutting Conditions

Si content ≤ 12,6 %

Min. - Optimum - Max.

ISO	Work Material	Hardness	Cutting Speed $v_c$ (m/min)	Feed Rate $f_z$ (mm/t)	Grade
<b>N</b>	Aluminum Alloy	—	2.000–2.500–3.000	0,05–0,13–0,20	DA1000

Si content > 12,6 %

Min. - Optimum - Max.

ISO	Work Material	Hardness	Cutting Speed $v_c$ (m/min)	Feed Rate $f_z$ (mm/t)	Grade
<b>N</b>	Aluminum Alloy	—	400–600–800	0,05–0,13–0,20	DA1000 DA90

Combined Milling of Cast Iron/Aluminum Alloy

Min. - Optimum - Max.

ISO	Work Material	Hardness	Cutting Speed $v_c$ (m/min)	Feed Rate $f_z$ (mm/t)	Grade
<b>K</b> <b>N</b>	Cast Iron/ Aluminum Alloy	—	300–400–500	0,05–0,13–0,20	DA90

The above recommended cutting conditions are meant as a guide. Actual conditions will depend on the individual machine rigidity, work clamp rigidity, depth of cut and other factors.

## Max. Allowable Spindle Speed

Cat. No.	n max (min <sup>-1</sup> )
ANXS 16025M12Z02	10.000
16030M16Z03	10.000
16030M16Z04	10.000
16032M16Z03	10.000
16032M16Z04	10.000
16040M16Z04	10.000
16040M16Z06	10.000

## Spare Parts

Sold separately.

Applicable Cutters	Clamp Screw		Adjustment Screw	Wrench	Adjustment Wrench	Assembly Wrench
ANXS160__M_Z__	BXA0310IP	2,0	HFJ	TRXW10IP	ANT	HFVT

The adjustment spanner (ANT) can also be used for height adjustment of the RF type cutters for high speed machining and the HF type cutters for high efficiency machining.

## Wiper Blade Step Amount

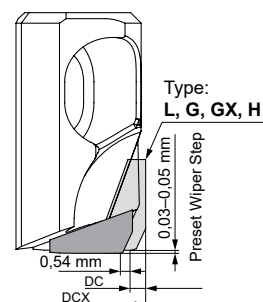

When using the wiper blade, in order to maintain balance, be sure to use a cutter with an even number of cutting edges and place the wiper blades at opposite positions.





# Coated & Solid Endmills

**J1-J44**

# J



## Coated Endmills

Selection Guide	According to Work Materials.....	J 2-3
GSX MILL Series	New <b>GSX</b> Global Standard Endmills .....	J 4-6
GSX MILL Series	<b>GSX</b> 20000 .....	J 7-11
	<b>GSX</b> 30000 .....	J12-13
Slotted Type	<b>GSXSLT</b> 30000.....	J14
	<b>GSX</b> 40000 .....	J15-19
Anti-Vibration Type	<b>GSXVL</b> 40000.....	J20-21
For High-Performance Milling	<b>EPMS</b> 4000/5000/6000 	J22-23
SSEH MILL Series for Exotic Alloys	<b>SSEHVL</b> 4000W-R / <b>SSEH</b> 4000W-R.....	J24-26
GS MILL Series, Roughing Type	<b>GSRE</b> 4000SF.....	J27
Hard Type	<b>GSH</b> 4000/6000/8000SF .....	J28
AURORA COAT MILL Series	<b>ASM</b> 2000/4000DL / DL-R .....	J29-30
SSUP MILL Series	<b>SSUP</b> 4000ZX/ZX-R.....	J32-33
Hard Type	<b>LHHM</b> 4000/6000/8000ZX .....	J31
	<b>EHHM</b> 4000/6000/8000ZX .....	J31
GSX Mills Ball Type	<b>GSXB</b> 20000 .....	J34
AURORA COAT Ball Type	<b>SNB</b> 2000DL.....	J35

## Uncoated Endmills

For Aluminium Cutting	<b>ASM</b> 2000.....	J36
SSEH MILL Series for Exotic Alloys	<b>SSEHVL</b> 4000-R / <b>SSEH</b> 4000-R.....	J37
Standard Type	<b>SSM</b> 2000/4000.....	J38-39
SUMIBORON "Helical Master" for Hardened Steel	<b>BNES</b> 1000.....	J40
SUMIBORON "Mould Finish Master" for Hardened Steel	<b>BNBP</b> 2R...4/6 .....	J41
SUMIDIA "Mould Finish Master" Binderless	<b>NPDRS</b> / <b>NPDB(S)</b> .....	J42-43

Solid Carbide  
Endmills

# Solid Carbide Endmills Selection Guide

## ● According to Work Materials

### Square Type

**General Steel (Common Use)**

Coated Sharp General

Global Endmills Standard  
**GSX Type**  
 ø 1–25 mm  
 • 2 Flutes  
 • 3 Flutes  
 • 4 Flutes  
 ⇨ J7–19

Anti-Vibration Radius Corner Endmills  
**GSXVL Type**  
 ø 2–25 mm  
 • 4 Flutes  
 ⇨ J20–21

### Legend

Grade Edge Type Usage

**General Steel (Special Use)**

Plunge Cut Multi-Purpose  
 Coated Sharp General  
**GSX MILL GSXSLT Type**  
 ø 1–16 mm  
 • 3 Flutes  
 ⇨ J14

High Efficiency  
 Coated Strong High Efficiency  
**UPMILL SSUP-ZX Type**  
 ø 2–20 mm  
 • 4 Flutes  
 ⇨ J32–33

High Efficiency  
 Coated Strong High Efficiency  
**ROUGHING ENDMILL GSRE-SF Type**  
 ø 6–20 mm  
 • 4 Flutes  
 ⇨ J27

**Hardened Steel**

High performance Type  
 Coated Strong High Efficiency  
**GS-MILL-HARD GSH-SF Type**  
 ø 1–20 mm  
 • 4 Flutes  
 • 6 Flutes  
 • 8 Flutes  
 ⇨ J28

High Rigidity Type  
 Coated Strong High Efficiency  
**HARD ENDMILL LHHM...ZX EHHM...ZX**  
 ø 3–32 mm  
 • 4 Flutes  
 • 6 Flutes  
 • 8 Flutes  
 ⇨ J31

SumiBoron Endmill  
 CBN  
 "Helical Master"  
**BNES Type**  
 ø 6–16 mm  
 • 1 Flute  
 ⇨ J40, M74

**Exotic Metals**

For Heat Resistant Steel  
 Coated Sharp High Efficiency  
 Radius Endmills Anti-Vibration  
**EPMS Type** New  
 ø 10–26 mm  
 • 6 Flutes  
 ⇨ J22–23

**Non-ferrous Metal**

SumiDia Endmill  
 PCD  
 SUMIDIA brazed  
**DFE Type**  
 ø 4–13 mm  
 • 1 Flute  
 • 2 Flutes  
 • 4 Flutes  
 ⇨ Stock in Japan

DLC-Coated Endmill  
 Coated Sharp General  
 AURORA COATED  
**ASM-DL Type**  
 ø 2–16 mm  
 • 2 Flutes  
 • 4 Flutes  
 ⇨ J29–30

**Exotic Metals**

For Heat Resistant Steel  
 Coated Sharp General  
 Radius Endmills Standard  
**SSEH Type**  
 ø 4.5–25 mm  
 • 4 Flutes  
 ⇨ J24, J26, J37

Anti-Vibration Radius Endmills  
**SSEHVL Type**  
 ø 4.5–25 mm  
 • 4 Flutes  
 ⇨ J24–25, J37



## ● According to Work Materials













### Ballnose Type

General Steel (Common Use)

Coated	General
<b>GSX MILL BALL</b> <b>GSXB Type</b> R 0,2–12,5 mm •2 Flutes 	
⇒ J34	

General Steel (Short Series)

Coated	Short	General	Coated	Short	General
<b>NEOBALL SHORT FLUTE</b> <b>S-SNB-ZX Type</b> R 1,5–15 mm •2 Flutes 			<b>ZX-COATED SHORT FLUTE</b> <b>S-SSB-ZX Type</b> R 1,5–4 mm •2 Flutes 		
⇒ Stock in Japan			⇒ Stock in Japan		

Hardened Steel	High Rigidity Type	Hardened Steel																	
	<table border="1"> <tr> <td>Coated</td> <td>Strong</td> <td>High Efficiency</td> </tr> <tr> <td colspan="3"> <b>HARDBALL</b>  <b>SHB-ZX Type</b>                      R 0,5–10 mm                      •2 Flutes   </td> </tr> <tr> <td colspan="3" style="text-align: right;">⇒ Stock in Japan</td> </tr> </table>	Coated	Strong	High Efficiency	<b>HARDBALL</b> <b>SHB-ZX Type</b> R 0,5–10 mm •2 Flutes 			⇒ Stock in Japan			<table border="1"> <tr> <td>CBN</td> <td style="text-align: center;"><b>MOULD</b> FINISH MASTER</td> <td>PCD</td> </tr> <tr> <td colspan="3">                     SUMIBORON brazed  <b>BNBP Type</b>                      R 0,2–1,0 mm                      •2 Flutes   </td> </tr> <tr> <td colspan="3" style="text-align: right;">⇒ J41, M75</td> </tr> </table>	CBN	<b>MOULD</b> FINISH MASTER	PCD	SUMIBORON brazed <b>BNBP Type</b> R 0,2–1,0 mm •2 Flutes 			⇒ J41, M75	
Coated	Strong	High Efficiency																	
<b>HARDBALL</b> <b>SHB-ZX Type</b> R 0,5–10 mm •2 Flutes 																			
⇒ Stock in Japan																			
CBN	<b>MOULD</b> FINISH MASTER	PCD																	
SUMIBORON brazed <b>BNBP Type</b> R 0,2–1,0 mm •2 Flutes 																			
⇒ J41, M75																			
		<table border="1"> <tr> <td colspan="2">                     SUMIDIA binderless  <b>NPDRS Type</b>                      R 0,2–2,0 mm                      •1 Flute                      Radius Endmill   </td> </tr> <tr> <td colspan="2" style="text-align: right;">⇒ J42–43, M76–76</td> </tr> </table>	SUMIDIA binderless <b>NPDRS Type</b> R 0,2–2,0 mm •1 Flute Radius Endmill 		⇒ J42–43, M76–76		<table border="1"> <tr> <td colspan="2"> <b>NPDB(S) Type</b>                      R 0,1–1,0 mm                      •1 Flute                      Ballnose Endmill   </td> </tr> <tr> <td colspan="2" style="text-align: right;">⇒ J42–43, M76–76</td> </tr> </table>	<b>NPDB(S) Type</b> R 0,1–1,0 mm •1 Flute Ballnose Endmill 		⇒ J42–43, M76–76									
SUMIDIA binderless <b>NPDRS Type</b> R 0,2–2,0 mm •1 Flute Radius Endmill 																			
⇒ J42–43, M76–76																			
<b>NPDB(S) Type</b> R 0,1–1,0 mm •1 Flute Ballnose Endmill 																			
⇒ J42–43, M76–76																			

Non-ferrous Metal

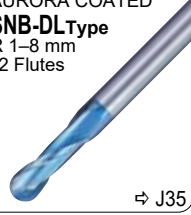
Coated	General
<b>DLC-Coated Endmill</b> <b>AURORA COATED</b> <b>SNB-DL Type</b> R 1–8 mm •2 Flutes 	
⇒ J35	

# GSX MILL Series



## ■ Characteristics and Applications

- ⊗ Wide variation of three flute types and four flute lengths enable use in a wide variety of applications.
- Fine carbide substrate provides high transverse rupture strength and excellent thermal shock resistance improving reliability in wet cutting applications.
- GSX Coating provides improved reliability and longer tool life.
- Large rake angle and unique flute design improve sharpness and chip evacuation.
- Cutting teeth with gash land improves corner flute strength.
- Sharper edge S type and fracture resistant C type added to the 2D size series.

## ● Wear Resistance

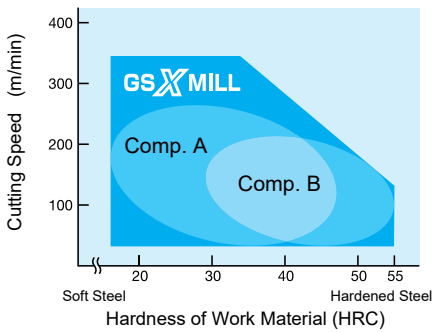

## ● Thermal Resistance

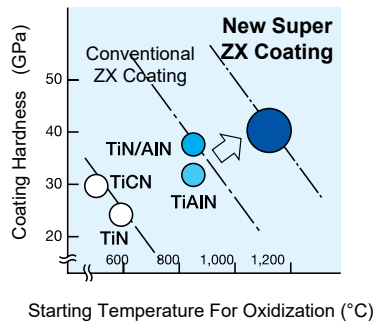

## ● Improved Chip Evacuation

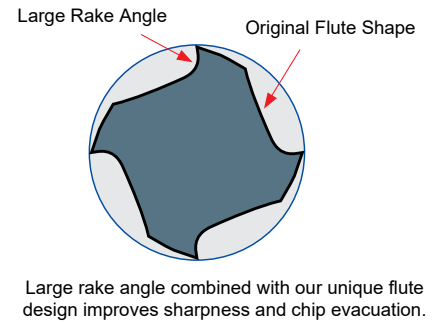

## ■ 2 cutting edge designs expand machining applications

Sharper edge S type and fracture resistant C type added to the 2D size series.

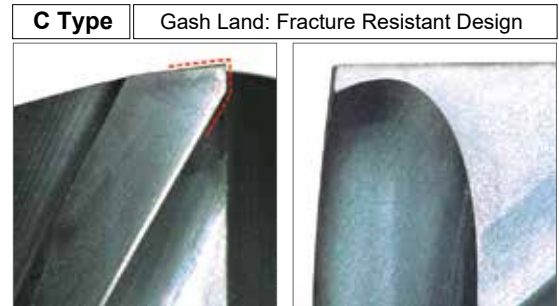
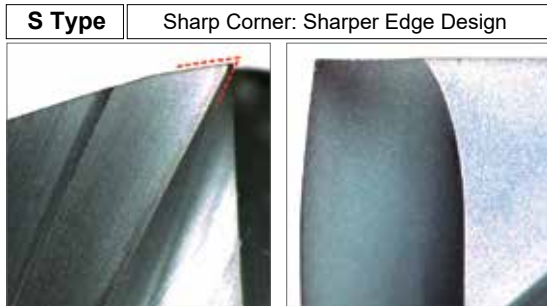

Note: In gash land drilling, some material remains as shown on the right. If you need sharp corners, use the S Type.

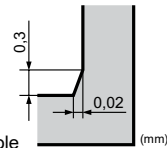

Ex.: Corner on a  $\phi$  10 mm hole (mm)

## ■ Application Range

P					H			M	S	K	N			
General Structure	Rolled Steel	Carbon Steel	Alloy Steel	Pre-hardened Steel	Hardened Steel			Stainless Steel	Ti Alloy	Heat Resistant Alloy	Cast Iron	Al Alloy	Cu Alloy	Graphite
					Tempered Die Steel	45 ~ 55 HRC	55 ~ 60 HRC							
○	○	○	○	○	○	○	○	○	○	○	○	○	○	○
○	○	○	○	○	○	○	○	○	○	○	○	○	○	○

○ : Best  
○ : Good

Blank : Not recommended  
\*1: GSXSLT30000C is recommended for 50 HRC or less

## ■ Recommended Milling Examples

Application	Surface Milling		Grooving		Groove Finishing	
	Rough	Finishing	Rough	Finishing	Rough	Finishing
Form						
<b>S Type</b>		○		○		○
<b>C Type</b>	○	○	○	○	○	○

S Type is best for removing inside corners.

\*2: Use with small depth of cut.

# NEW "Global Standard" Endmills GSX MILL Series



Large rake angle and unique flute design improve sharpness and excellent chip evacuation.

## Product Range

Application	No. of Teeth	Flute Length				
		1,5 D	2 D		3 D	4 D
		C Type	S Type	C Type	C Type	C Type
General Purpose	2 Flutes	GSX20000C-1.5D ⇨ J 7	GSX20000S-2D ⇨ J 8	GSX20000C-2D ⇨ J 9	GSX20000C-3D ⇨ J 10	GSX20000C-4D ⇨ J 11
	3 Flutes	GSX30000C-1.5D ⇨ J 12		GSX30000C-2D ⇨ J 13		
	4 Flutes	GSX40000C-1.5D ⇨ J 15	GSX40000S-2D ⇨ J 16	GSX40000C-2D ⇨ J 17	GSX40000C-3D ⇨ J 18	GSX40000C-4D ⇨ J 19
Compound Endmilling	3 Flutes	GSXSLT30000C-1.5D ⇨ J 14				

## Multi-Purpose "GSX-SLT" Slot Type

- Optimized flute design of slotted 3 flute (1.5D) short type reduces cutting resistance.

- Allows drilling and slot milling and other continuous (compound) applications.
- Perfect for use with thin sheets and small machining centres

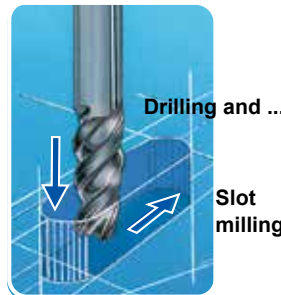

## Application Examples

### Carbon Steel Grooving with GSX20000C

GSX 20000C	Competitor	Gash land for stronger cutting edge.
		Tool dimension: $\phi 6$ (2 Flutes)
		Work material: C50
		Cutting speed: $v_c = 87$ m/min $n = 4615$ rpm
		Feed rate: $f_z = 0,06$ mm/teeth $v_f = 553$ mm/min
		Depth of cut: $a_p = 3$ mm
		Wide of cut: $a_e = 6$ mm
		Cooland: Dry
		Vertical machining centre (BT50)

**Breakage**

### Cast Iron Grooving with GSX20000C

GSX 20000C	Competitor	GSX coating for improved wear resistance.
		Tool dimension: $\phi 10$ (2 Flutes)
		Work material: GGG60
		Cutting speed: $v_c = 66$ m/min $n = 2100$ rpm
		Feed rate: $f_z = 0,072$ mm/teeth $v_f = 302$ mm/min
		Depth of cut: $a_p = 5$ mm, 5 passes
		Wide of cut: $a_e = 10$ mm
		Cooland: Dry
		Vertical machining centre (BT40)

**High Wear**

### Stainless Steel Machining with GSX20000C

GSX 20000C	Competitor	Improved reliability even under wet machining.
		Tool dimension: $\phi 10$ (2 Flutes)
		Work material: X5 CrNi 1812
		Cutting speed: $v_c = 50$ m/min $n = 1591$ rpm
		Feed rate: $f_z = 0,04$ mm/teeth $v_f = 27$ mm/min
		Depth of cut: $a_p = 10$ mm
		Wide of cut: $a_e = 0,5$ mm
		Cooland: Wet
		Vertical machining centre (BT50)

**Coating peel off**

### Surface Milling C50 with GSX20000S

GSX 20000S	Competitor	S type delivers optimum cutting performance.
		Tool dimension: $\phi 6$ (2 Flutes)
		Work material: C50
		Cutting speed: $v_c = 87$ m/min $n = 4615$ rpm
		Feed rate: $f_z = 0,06$ mm/teeth $v_f = 553$ mm/min
		Depth of cut: $a_p = 10$ mm
		Wide of cut: $a_e = 0,3$ mm
		Cooland: Dry
		Vertical machining centre (BT50)

**Chipping**



# GSX MILL Series



⇒ J 20, J 21

## GSX MILL Anti-vibration Type (Square/Radius)

### Characteristics and Applications

- Optimized irregular pitch and lead affords:
  - Drastically improved chattering and fracture resistance !
  - Less cutting force Allows high-speed, high-feed cutting.
- Rounded lands greatly improve machined surface quality (from  $\phi 4$  and up).
- New fine-grained carbide substrate and special coating for better rigidity and thermal and wear resistance.

### Product Range

#### GSX MILL Anti-vibration Square Type

Series	No. of Teeth	Serie	DC (mm)
<b>GSXVL4000-2.5D</b>	4 Flutes		$\phi 2 - \phi 20$ ⇒ J 20

#### GSX MILL Anti-vibration Corner Radius Type

Series	No. of Teeth	Serie	DC (mm)
<b>GSXVL4000-R-2.5D</b>	4 Flutes		$\phi 3 - \phi 20$ ⇒ J 21

### Cutting Range

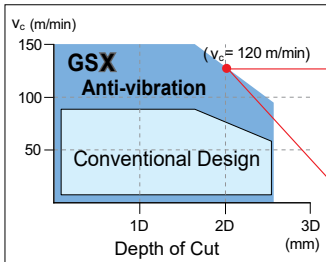

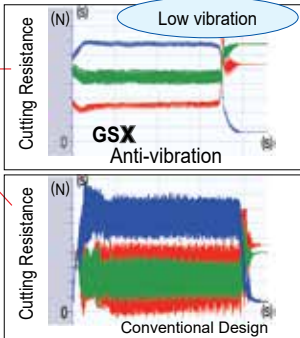

### Cutting Resistance



### Application Range

#### Surface Finish Quality

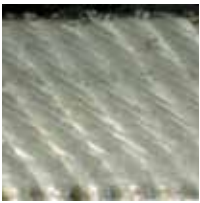
GSX Anti-vibration	Competitor's Anti-vibration	Conventional Design
		
No Chattering Clean Surface	Minute Chattering Poor Surface	Heavy Chattering Poor Surface
Work material: C50 Grooving: $\phi 10$ Tool dimension: $\phi 10$	Cutting Conditions: $n = 4.800 \text{ rpm}$ $v_f = 800 \text{ mm/min}$ $a_p = 10 \text{ mm}$ Equipment: BT50	



⇒ J 34

## GSX MILL Ball

### Characteristics and Applications

- New coating combined with a fine-grained carbide substrate affords better thermal and wear resistance.
  - Large helix angle on cutting edge reduces cutting resistance.
  - Unique pocket design and expanded pocket area promotes better chip evacuation.
- ☒ Expands the range of machineable material from soft to hardened steels, and offers reliability and longer tool life.

### Product Range

Series	No. of Teeth	Serie	DC (mm)
<b>GSX-B 20000</b>	2 Flutes		$R=\phi 0,2 - \phi 15$ (DC= $0,2 - 30$ ) ⇒ J 36

### Application Range

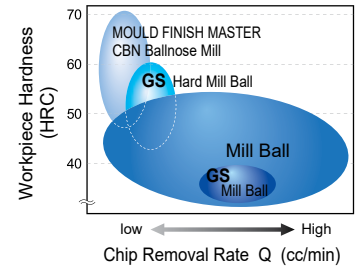

### Application Examples

#### Flank Wear

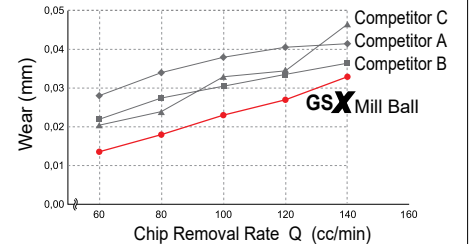

#### GSX Ball (Cutting Length 140 m)



Able to continue

#### Conventional Tool (Cutting Length 80 m)



Unable to continue

Work Material : X40CrVMo5-1 (50HRC)  
Tool Dimensions : R3 (2 Flutes)  
Cutting Conditions :  $v_c = 179 \text{ m/min}$  ( $n = 9.500 \text{ rpm}$ )  
 $v_f = 2.250 \text{ mm/min}$  ( $f_z = 0,12 \text{ mm/t}$ )  
 $a_p = 0,2 \sim 1,0 \text{ mm}$ ,  $a_e = 0,3 \text{ mm}$ , wet  
Equipment Vertical Machining Centre BT40

Chipping in centre  
Heavy wear on flank face



Structural Steel	Carbon Steel	Alloy Steel	Pre-hardened Steel	Tempered D2e Steel	Hardened Steel	Stainless Steel	Ti Alloy / Heat Resistant Alloy	Cast Iron	Al Alloy	Cu Alloy	Graphite
------------------	--------------	-------------	--------------------	--------------------	----------------	-----------------	---------------------------------	-----------	----------	----------	----------

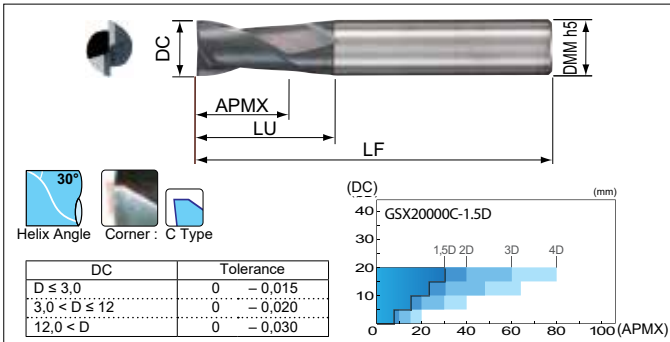

Grade: ACF20

### Endmill Identification (GSX MILL Series)

**GSX 2 0100 C - 1.5D**

Series Code    No. of Teeth    Diameter    Cutting Edge    Cutting Edge Length

S: Sharp Edge  
C: Gash Land Drilling

### Endmills

Cat. No.	Stock	DC	APMX	LU	LF	DMM
GSX 20100C-1.5D	●	1,0	1,5	2,5	40	4
GSX 20150C-1.5D	○	1,5	2,3	3,3	40	4
GSX 20200C-1.5D	●	2,0	3,0	4,0	40	4
GSX 20250C-1.5D	●	2,5	3,8	4,8	40	4
GSX 20300C-1.5D	●	3,0	4,5	6,0	45	6
GSX 20350C-1.5D	●	3,5	5,3	6,8	45	6
GSX 20400C-1.5D	●	4,0	6,0	7,5	45	6
GSX 20450C-1.5D	●	4,5	6,8	8,3	50	6
GSX 20500C-1.5D	●	5,0	7,5	9,5	50	6
GSX 20550C-1.5D	●	5,5	8,3	10,3	50	6
GSX 20600C-1.5D	●	6,0	9,0	-	50	6
GSX 20700C-1.5D	●	7,0	11,0	13,0	60	8
GSX 20800C-1.5D	●	8,0	12,0	-	60	8
GSX 20900C-1.5D	●	9,0	14,0	16,0	70	10
GSX 21000C-1.5D	●	10,0	15,0	-	70	10
GSX 21200C-1.5D	●	12,0	18,0	-	75	12
GSX 21400C-1.5D		14,0	21,0	24,5	90	16
GSX 21500C-1.5D		15,0	23,0	26,5	90	16
GSX 21600C-1.5D		16,0	24,0	-	90	16
GSX 22000C-1.5D		20,0	30,0	-	100	20

### Recommended Cutting Conditions

- For stable machining performance use rigid, high-precision machines and holders.
- Use air blowing when dry machining.
- Use wet machining for stainless steel, heat resistant alloy, and titanium alloy applications.
- If the machine cannot achieve the recommended spindle speed, please use the max. spindle speed available.

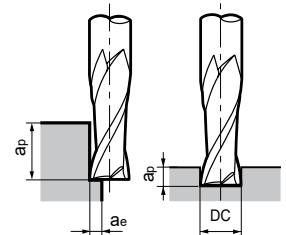

### Shoulder Milling

Work Material	Structural Steel		Carbon Steel (150 to 250HB)		Cast Iron		Alloy Steel (25 to 35HRC)		Tempered Steel, Hardened Steel (35 to 45HRC)		Hardened Steel (45 to 55HRC)		Stainless Steel		Heat Resistant Steel, Titanium Alloy			
	Spindle Speed (rpm)	Feed Rate (mm/min)	Spindle Speed (rpm)	Feed Rate (mm/min)	Spindle Speed (rpm)	Feed Rate (mm/min)	Spindle Speed (rpm)	Feed Rate (mm/min)	Spindle Speed (rpm)	Feed Rate (mm/min)	Spindle Speed (rpm)	Feed Rate (mm/min)	Spindle Speed (rpm)	Feed Rate (mm/min)	Spindle Speed (rpm)	Feed Rate (mm/min)		
1,0	19.600	250	19.600	250	19.600	250	18.300	180	12.700	100	9.000	60	11.000	70	9.000	50		
2,0	11.200	340	11.200	340	11.200	340	10.500	240	7.300	130	5.300	80	6.400	90	5.300	70		
4,0	6.400	460	6.400	460	6.400	460	6.000	320	4.200	180	3.000	110	3.600	120	3.000	90		
6,0	4.600	560	4.600	560	4.600	560	4.300	400	3.000	210	2.200	130	2.700	140	2.200	100		
8,0	3.400	560	3.400	560	3.400	560	3.200	400	2.200	210	1.600	130	2.000	140	1.600	100		
10,0	2.800	560	2.800	560	2.800	560	2.600	400	1.800	210	1.300	130	1.600	140	1.300	100		
12,0	2.300	560	2.300	560	2.300	560	2.200	400	1.500	210	1.100	130	1.300	140	1.100	100		
16,0	1.700	450	1.700	450	1.700	450	1.600	320	1.100	180	800	100	1.000	110	800	85		
20,0	1.350	380	1.350	380	1.350	380	1.300	280	900	160	650	90	800	100	650	75		
Shoulder cutting	ap		1,5 DC								1,0 DC							
	ae		0,05 DC								0,02 DC							

### Grooving

Work Material	Structural Steel		Carbon Steel (150 to 250HB)		Cast Iron		Alloy Steel (25 to 35HRC)		Tempered Steel, Hardened Steel (35 to 45HRC)		Hardened Steel (45 to 55HRC)		Stainless Steel		Heat Resistant Steel, Titanium Alloy	
	Spindle Speed (rpm)	Feed Rate (mm/min)	Spindle Speed (rpm)	Feed Rate (mm/min)	Spindle Speed (rpm)	Feed Rate (mm/min)	Spindle Speed (rpm)	Feed Rate (mm/min)	Spindle Speed (rpm)	Feed Rate (mm/min)	Spindle Speed (rpm)	Feed Rate (mm/min)	Spindle Speed (rpm)	Feed Rate (mm/min)	Spindle Speed (rpm)	Feed Rate (mm/min)
1,0	19.600	200	19.600	250	19.600	250	18.300	180	12.700	100	9.000	60	11.000	50	4.500	20
2,0	11.200	270	11.200	340	11.200	340	10.500	240	7.300	130	5.300	80	6.400	65	2.650	25
4,0	6.400	370	6.400	460	6.400	460	6.000	320	4.200	180	3.000	110	3.600	80	1.500	35
6,0	4.600	450	4.600	560	4.600	560	4.300	400	3.000	210	2.200	130	2.700	100	1.100	40
8,0	3.400	450	3.400	560	3.400	560	3.200	400	2.200	210	1.600	130	2.000	100	800	40
10,0	2.800	450	2.800	560	2.800	560	2.600	400	1.800	210	1.300	130	1.600	100	650	40
12,0	2.300	450	2.300	560	2.300	560	2.200	400	1.500	210	1.100	130	1.300	100	500	40
16,0	1.700	360	1.700	450	1.700	450	1.600	320	1.100	180	800	100	1.000	80	400	35
20,0	1.350	300	1.350	380	1.350	380	1.300	280	900	160	650	90	800	70	320	30
Grooving	ap		0,2 DC				0,5 DC				0,2 DC		0,05 DC		0,2 DC	





Structural Steel	Carbon Steel	Alloy Steel	Pre-hardened Steel	Tempered D2E Steel	Hardened Steel	Stainless Steel	Ti Alloy / Heat Resistant Alloy	Cast Iron	Al Alloy	Cu Alloy	Graphite
○	○	○	○	○	○	○	○	○	○	○	○

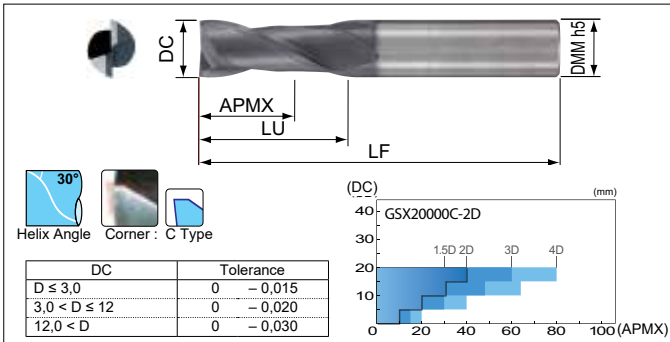

Grade: ACF20

Endmill Identification (GSX MILL Series)

**GSX 2 0050 C - 2D**

Series Code    No. of Teeth    Diameter    Cutting Edge    Cutting Edge Length

S: Sharp Edge  
C: Gash Land Drilling

Endmills

Cat. No.	Stock	DC	APMX	LU	LF	DMM
GSX 20050C-2D	○	0,5	1,0	1,4	40	4
GSX 20100C-2D	●	1,0	2,0	3,0	40	4
GSX 20150C-2D	○	1,5	3,0	4,0	40	4
GSX 20200C-2D	●	2,0	4,0	5,0	40	4
GSX 20250C-2D	●	2,5	5,0	6,0	40	4
GSX 20300C-2D	●	3,0	6,0	7,5	45	6
GSX 20350C-2D	●	3,5	7,0	8,5	45	6
GSX 20400C-2D	●	4,0	8,0	9,5	45	6
GSX 20450C-2D	●	4,5	9,0	10,5	50	6
GSX 20500C-2D	●	5,0	10,0	12,0	50	6
GSX 20550C-2D	●	5,5	11,0	13,0	50	6
GSX 20600C-2D	●	6,0	12,0	—	50	6
GSX 20700C-2D	●	7,0	14,0	16,0	60	8
GSX 20800C-2D	●	8,0	16,0	—	60	8
GSX 20900C-2D	○	9,0	18,0	20,0	70	10
GSX 21000C-2D	●	10,0	20,0	—	70	10
GSX 21200C-2D	●	12,0	24,0	—	75	12
GSX 21400C-2D	●	14,0	28,0	31,5	90	16
GSX 21500C-2D	●	15,0	30,0	33,5	90	16
GSX 21600C-2D	●	16,0	32,0	—	90	16
GSX 22000C-2D	●	20,0	40,0	—	100	20

Recommended Cutting Conditions

- For stable machining performance use rigid, high-precision machines and holders.
- Use air blowing when dry machining.
- Use wet machining for stainless steel, heat resistant alloy, and titanium alloy applications.
- If chattering is a problem, reduce the spindle speed and feed rate indicated in the table below by the same ratio, or reduce the depth of cut.
- If the machine cannot achieve the recommended spindle speed, please use the max. spindle speed available.

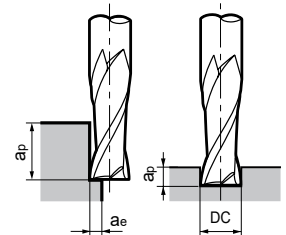

Shoulder Milling

Work Material	Structural Steel		Carbon Steel (150 to 250HB)		Cast Iron		Alloy Steel (25 to 35HRC)		Tempered Steel, Hardened Steel (35 to 45HRC)		Hardened Steel (45 to 55HRC)		Stainless Steel		Heat Resistant Steel, Titanium Alloy	
	Spindle Speed (rpm)	Feed Rate (mm/min)	Spindle Speed (rpm)	Feed Rate (mm/min)	Spindle Speed (rpm)	Feed Rate (mm/min)	Spindle Speed (rpm)	Feed Rate (mm/min)	Spindle Speed (rpm)	Feed Rate (mm/min)	Spindle Speed (rpm)	Feed Rate (mm/min)	Spindle Speed (rpm)	Feed Rate (mm/min)	Spindle Speed (rpm)	Feed Rate (mm/min)
1,0	19.600	250	19.600	250	19.600	250	18.300	180	12.700	100	9.000	60	11.000	70	9.000	50
2,0	11.200	340	11.200	340	11.200	340	10.500	240	7.300	130	5.300	80	6.400	90	5.300	70
4,0	6.400	460	6.400	460	6.400	460	6.000	320	4.200	180	3.000	110	3.600	120	3.000	90
6,0	4.600	560	4.600	560	4.600	560	4.300	400	3.000	210	2.200	130	2.700	140	2.200	100
8,0	3.400	560	3.400	560	3.400	560	3.200	400	2.200	210	1.600	130	2.000	140	1.600	100
10,0	2.800	560	2.800	560	2.800	560	2.600	400	1.800	210	1.300	130	1.600	140	1.300	100
12,0	2.300	560	2.300	560	2.300	560	2.200	400	1.500	210	1.100	130	1.300	140	1.100	100
16,0	1.700	450	1.700	450	1.700	450	1.600	320	1.100	180	800	100	1.000	110	800	85
20,0	1.350	380	1.350	380	1.350	380	1.300	280	900	160	650	90	800	100	650	75
Shoulder cutting	ap		1,5 DC						1,0 DC							
	ae		0,05 DC						0,02 DC							

Grooving

Work Material	Structural Steel		Carbon Steel (150 to 250HB)		Cast Iron		Alloy Steel (25 to 35HRC)		Tempered Steel, Hardened Steel (35 to 45HRC)		Hardened Steel (45 to 55HRC)		Stainless Steel		Heat Resistant Steel, Titanium Alloy	
	Spindle Speed (rpm)	Feed Rate (mm/min)	Spindle Speed (rpm)	Feed Rate (mm/min)	Spindle Speed (rpm)	Feed Rate (mm/min)	Spindle Speed (rpm)	Feed Rate (mm/min)	Spindle Speed (rpm)	Feed Rate (mm/min)	Spindle Speed (rpm)	Feed Rate (mm/min)	Spindle Speed (rpm)	Feed Rate (mm/min)	Spindle Speed (rpm)	Feed Rate (mm/min)
1,0	19.600	200	19.600	250	19.600	250	18.300	180	12.700	100	9.000	60	11.000	50	4.500	20
2,0	11.200	270	11.200	340	11.200	340	10.500	240	7.300	130	5.300	80	6.400	65	2.650	25
4,0	6.400	370	6.400	460	6.400	460	6.000	320	4.200	180	3.000	110	3.600	80	1.500	35
6,0	4.600	450	4.600	560	4.600	560	4.300	400	3.000	210	2.200	130	2.700	100	1.100	40
8,0	3.400	450	3.400	560	3.400	560	3.200	400	2.200	210	1.600	130	2.000	100	800	40
10,0	2.800	450	2.800	560	2.800	560	2.600	400	1.800	210	1.300	130	1.600	100	650	40
12,0	2.300	450	2.300	560	2.300	560	2.200	400	1.500	210	1.100	130	1.300	100	500	40
16,0	1.700	360	1.700	450	1.700	450	1.600	320	1.100	180	800	100	1.000	80	400	35
20,0	1.350	300	1.350	380	1.350	380	1.300	280	900	160	650	90	800	70	320	30
Grooving	ap		0,2 DC				0,5 DC				0,2 DC		0,05 DC		0,2 DC	



# GSX 20000C-3D Type

Coated Carbide

Grades

Coating

Structural Steel	Carbon Steel	Alloy Steel	Pre-hardened Steel	Tempered Die Steel	Hardened Steel	Stainless Steel	Ti Alloy / Heat Resistant Alloy	Cast Iron	Al Alloy	Cu Alloy	Graphite
○	○	○	○	○	○	○	○	○	○	○	○

DC	Tolerance
D ≤ 3,0	0 - 0,015
3,0 < D ≤ 12	0 - 0,020
12,0 < D	0 - 0,030

Grade: ACF20

## Endmills

Cat. No.	Stock	(mm)				
		DC	APMX	LU	LF	DMM
GSX 20100C-3D	●	1,0	3,0	4,0	40	4
GSX 20150C-3D	●	1,5	4,5	5,5	40	4
GSX 20200C-3D	●	2,0	6,0	7,0	40	4
GSX 20250C-3D	●	2,5	7,5	8,5	40	4
GSX 20300C-3D	●	3,0	9,0	10,5	50	6
GSX 20400C-3D	●	4,0	12,0	13,5	50	6
GSX 20500C-3D	●	5,0	15,0	17,0	50	6
GSX 20600C-3D	●	6,0	18,0	—	50	6
GSX 20800C-3D	●	8,0	24,0	—	70	8
GSX 21000C-3D	●	10,0	30,0	—	90	10
GSX 21200C-3D	●	12,0	36,0	—	90	12
GSX 21600C-3D	●	16,0	48,0	—	110	16
GSX 22000C-3D	○	20,0	60,0	—	120	20

## Endmill Identification (GSX MILL Series)

# GSX 2 0100 C - 3D

Series Code    No. of Teeth    Diameter    Cutting Edge    Cutting Edge Length

S: Sharp Edge  
C: Gash Land Drilling

## Recommended Cutting Conditions

- For stable machining performance use rigid, high-precision machines and holders.
- Use air blowing when dry machining.
- Use wet machining for stainless steel, heat resistant alloy, and titanium alloy applications.
- In rare cases, chattering may occur in early milling stages, dissipating after 2m of cutting.
- If chattering is a problem, reduce the spindle speed and feed rate indicated in the table below by the same ratio, or reduce the depth of cut.
- If the machine cannot achieve the recommended spindle speed, please use the max. spindle speed available.

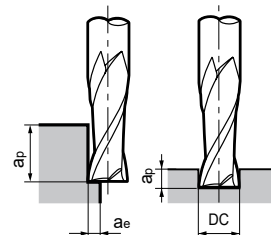

## Shoulder Milling

Work Material	Structural Steel		Carbon Steel (150 to 250HB)		Cast Iron		Alloy Steel (25 to 35HRC)		Tempered Steel, Hardened Steel (35 to 45HRC)		Hardened Steel (45 to 55HRC)		Stainless Steel		Heat Resistant Steel, Titanium Alloy		
	Cond.	Spindle Speed (rpm)	Feed Rate (mm/min)	Spindle Speed (rpm)	Feed Rate (mm/min)	Spindle Speed (rpm)	Feed Rate (mm/min)	Spindle Speed (rpm)	Feed Rate (mm/min)	Spindle Speed (rpm)	Feed Rate (mm/min)	Spindle Speed (rpm)	Feed Rate (mm/min)	Spindle Speed (rpm)	Feed Rate (mm/min)	Spindle Speed (rpm)	Feed Rate (mm/min)
DC (mm)																	
1,0		16.600	190	16.600	190	16.600	190	15.500	140	10.500	70	7.500	45	9.400	50	7.500	35
2,0		9.500	250	9.500	250	9.500	250	9.000	200	6.200	120	4.500	60	5.200	70	4.500	50
4,0		5.200	330	5.200	330	5.200	330	4.800	200	3.400	150	2.250	75	2.600	90	2.250	65
6,0		3.500	360	3.500	360	3.500	360	3.200	250	2.550	170	1.500	90	1.700	100	1.500	80
8,0		2.600	320	2.600	320	2.600	320	2.400	240	1.900	170	1.100	90	1.300	105	1.100	80
10,0		2.100	300	2.100	300	2.100	300	1.900	230	1.500	170	900	90	1.000	100	900	80
12,0		1.750	280	1.750	280	1.750	280	1.600	230	1.250	170	750	90	850	100	750	80
16,0		1.300	240	1.300	240	1.300	240	1.200	200	950	150	550	75	650	85	550	65
20,0		1.050	220	1.050	220	1.050	220	950	180	750	140	450	70	500	75	450	60
Shoulder cutting	ap	2,5 DC								2,0 DC							
	ae	< ø3: 0,05 DC , ≤ ø3: 0,1 DC								0,02 DC							

## Grooving

Work Material	Structural Steel		Carbon Steel (150 to 250HB)		Cast Iron		Alloy Steel (25 to 35HRC)		Tempered Steel, Hardened Steel (35 to 45HRC)		Hardened Steel (45 to 55HRC)		Stainless Steel		Heat Resistant Steel, Titanium Alloy		
	Cond.	Spindle Speed (rpm)	Feed Rate (mm/min)	Spindle Speed (rpm)	Feed Rate (mm/min)	Spindle Speed (rpm)	Feed Rate (mm/min)	Spindle Speed (rpm)	Feed Rate (mm/min)	Spindle Speed (rpm)	Feed Rate (mm/min)	Spindle Speed (rpm)	Feed Rate (mm/min)	Spindle Speed (rpm)	Feed Rate (mm/min)	Spindle Speed (rpm)	Feed Rate (mm/min)
DC (mm)																	
1,0		16.600	70	16.600	80	16.600	80	15.500	50	10.500	50	7.500	35	9.400	30	3.750	10
2,0		9.500	80	9.500	100	9.500	100	9.000	90	6.200	60	4.500	45	5.200	40	2.250	15
4,0		5.200	120	5.200	150	5.200	150	4.800	120	3.400	80	2.200	50	2.600	50	1.250	20
6,0		3.500	140	3.500	170	3.500	170	3.200	130	2.550	100	1.500	50	1.700	60	950	25
8,0		2.600	140	2.600	160	2.600	160	2.400	130	1.900	100	1.100	50	1.300	60	700	25
10,0		2.100	130	2.100	150	2.100	150	1.900	120	1.500	90	900	50	1.000	60	550	25
12,0		1.750	130	1.750	150	1.750	150	1.600	120	1.250	90	750	50	850	60	450	25
16,0		1.300	110	1.300	130	1.300	130	1.200	110	950	80	550	45	650	50	350	20
20,0		1.050	100	1.050	120	1.050	120	950	100	750	70	450	40	500	40	280	15
Grooving	ap	0,1 DC		0,2 DC				0,05 DC				0,1 D					
	ae																

● = Euro stock  
○ = Japan stock

Coated Carbide **GSX**

Grades Coating

Structural Steel	Carbon Steel	Alloy Steel	Pre-hardened Steel	Tempered Die Steel	Hardened Steel	Stainless Steel	Ti Alloy / Heat Resistant Alloy	Cast Iron	Al Alloy	Cu Alloy	Graphite
○	○	○	○	○	○	○	○	○	○	○	○

DC	Tolerance
D ≤ 3,0	0 - 0,015
3,0 < D ≤ 12	0 - 0,020
12,0 < D	0 - 0,030

Grade: ACF20

Endmills

Cat. No.	Stock	DC	APMX	LU	LF	DMM
GSX 20100C-4D	●	1,0	4,0	5,0	40	4
GSX 20150C-4D	●	1,5	6,0	7,0	40	4
GSX 20200C-4D	●	2,0	8,0	9,0	40	4
GSX 20250C-4D	●	2,5	10,0	11,0	50	4
GSX 20300C-4D	●	3,0	12,0	13,5	50	6
GSX 20400C-4D	●	4,0	16,0	17,5	50	6
GSX 20500C-4D	●	5,0	20,0	22,0	60	6
GSX 20600C-4D	●	6,0	24,0	-	60	6
GSX 20800C-4D	●	8,0	32,0	-	80	8
GSX 21000C-4D	●	10,0	40,0	-	90	10
GSX 21200C-4D	○	12,0	48,0	-	100	12
GSX 21600C-4D	○	16,0	64,0	-	120	16
GSX 22000C-4D	○	20,0	80,0	-	140	20

Endmill Identification (GSX MILL Series)

**GSX 2 0100 C - 4D**

Series Code No. of Teeth Diameter Cutting Edge Cutting Length

S: Sharp Edge  
C: Gash Land Drilling

Recommended Cutting Conditions

- For stable machining performance use rigid, high-precision machines and holders.
- Use air blowing when dry machining.
- Use wet machining for stainless steel, heat resistant alloy, and titanium alloy applications.
- In rear cases, chattering may occur in early milling stages, dissipating after 2 m of cutting.
- If chattering is a problem, reduce the spindle speed and feed rate indicated in the table below by the same ratio, or reduce the depth of cut.
- This series is not recommended for grooving.
- If the machine cannot achieve the recommended spindle speed, please use the max. spindle speed available.

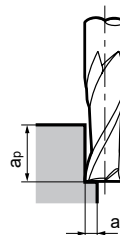

Shoulder Milling

Work Material	Structural Steel		Carbon Steel (150 to 250HB)		Cast Iron		Alloy Steel (25 to 35HRC)		Tempered Steel, Hardened Steel (35 to 45HRC)		Hardened Steel (45 to 55HRC)		Stainless Steel		Heat Resistant Steel, Titanium Alloy	
	Spindle Speed (rpm)	Feed Rate (mm/min)	Spindle Speed (rpm)	Feed Rate (mm/min)	Spindle Speed (rpm)	Feed Rate (mm/min)	Spindle Speed (rpm)	Feed Rate (mm/min)	Spindle Speed (rpm)	Feed Rate (mm/min)	Spindle Speed (rpm)	Feed Rate (mm/min)	Spindle Speed (rpm)	Feed Rate (mm/min)	Spindle Speed (rpm)	Feed Rate (mm/min)
1,0	9.000	130	9.000	130	9.000	130	7.000	95	6.500	50	4.500	30	5.400	40	4.500	25
2,0	4.500	180	4.500	180	4.500	180	3.500	120	3.200	70	2.300	40	2.700	50	2.300	35
4,0	2.250	240	2.250	240	2.250	240	1.750	160	1.600	95	1.200	60	1.350	65	1.200	40
6,0	1.500	300	1.500	300	1.500	300	1.150	170	1.050	110	800	70	900	70	800	50
8,0	1.100	260	1.100	260	1.100	260	850	170	800	110	600	70	660	70	600	50
10,0	900	250	900	250	900	250	700	160	650	110	460	70	540	70	460	50
12,0	750	240	750	240	750	240	580	160	520	110	400	70	450	70	400	50
16,0	550	200	550	200	550	200	440	140	400	95	300	55	330	60	300	45
20,0	450	180	450	180	450	180	350	120	320	85	240	45	270	50	240	40
Shoulder cutting	ap	3,5 DC						3,0 DC								
	ae	0,08 DC						0,04 DC								



# GSX 30000C-1.5D Type

Coated Carbide  
Grades Coating

Structural Steel	Carbon Steel	Alloy Steel	Pre-hardened Steel	Tempered Die Steel	Hardened Steel	Stainless Steel	Ti Alloy / Heat Resistant Alloy	Cast Iron	Al Alloy	Cu Alloy	Graphite
○	○	○	○	○	45-55 HRC	55-60 HRC	60-65 HRC	○	○	○	○

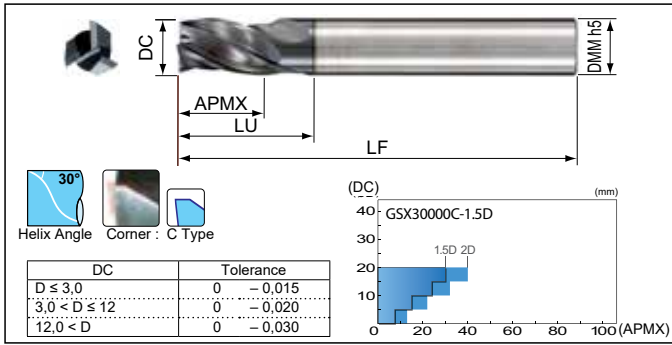

Grade: ACF20

## Endmills

Cat. No.	Stock	DC	APMX	LU	LF	DMM
GSX 30100C-1.5D	●	1,0	1,5	2,5	40	4
GSX 30150C-1.5D	●	1,5	2,3	3,3	40	4
GSX 30200C-1.5D	●	2,0	3,0	4,0	40	4
GSX 30250C-1.5D	●	2,5	3,8	4,8	40	4
GSX 30300C-1.5D	●	3,0	4,5	6,0	45	6
GSX 30400C-1.5D	●	4,0	6,0	7,5	45	6
GSX 30500C-1.5D	●	5,0	7,5	9,5	50	6
GSX 30600C-1.5D	●	6,0	9,0	-	50	6
GSX 30700C-1.5D	●	7,0	11,0	13,0	60	8
GSX 30800C-1.5D	●	8,0	12,0	-	60	8
GSX 30900C-1.5D	○	9,0	14,0	16,0	70	10
GSX 31000C-1.5D	●	10,0	15,0	-	70	10
GSX 31200C-1.5D	●	12,0	18,0	-	75	12
GSX 31600C-1.5D	●	16,0	24,0	-	90	16
GSX 32000C-1.5D	●	20,0	30,0	-	100	20

## Endmill Identification (GSX MILL Series)

# GSX 3 0100 C - 1.5D

Series Code No. of Teeth Diameter Cutting Edge Cutting Edge Length

S: Sharp Edge  
C: Gash Land Drilling

## Recommended Cutting Conditions

- For stable machining performance use rigid, high-precision machines and holders.
- Use air blowing when dry machining.
- Use wet machining for stainless steel, heat resistant alloy, and titanium alloy applications.
- If the machine cannot achieve the recommended spindle speed, please use the max. spindle speed available.

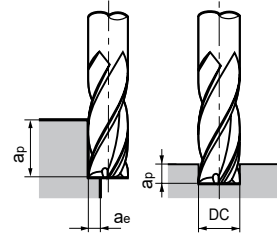

## Shoulder Milling

Work Material Cond.	Structural Steel		Carbon Steel (150 to 250HB)		Cast Iron		Alloy Steel (25 to 35HRC)		Tempered Steel, Hardened Steel (35 to 45HRC)		Hardened Steel (45 to 55HRC)		Stainless Steel		Heat Resistant Steel, Titanium Alloy	
	Spindle Speed (rpm)	Feed Rate (mm/min)	Spindle Speed (rpm)	Feed Rate (mm/min)	Spindle Speed (rpm)	Feed Rate (mm/min)	Spindle Speed (rpm)	Feed Rate (mm/min)	Spindle Speed (rpm)	Feed Rate (mm/min)	Spindle Speed (rpm)	Feed Rate (mm/min)	Spindle Speed (rpm)	Feed Rate (mm/min)	Spindle Speed (rpm)	Feed Rate (mm/min)
1,0	19.600	300	19.600	300	19.600	300	18.300	210	12.700	130	9.000	80	11.000	90	9.000	65
2,0	11.200	410	11.200	410	11.200	410	10.500	280	7.300	170	5.300	100	6.400	120	5.300	90
4,0	6.400	550	6.400	550	6.400	550	6.000	370	4.200	230	3.000	140	3.600	150	3.000	120
6,0	4.600	670	4.600	670	4.600	670	4.300	460	3.000	270	2.200	170	2.700	180	2.200	130
8,0	3.400	670	3.400	670	3.400	670	3.200	460	2.200	270	1.600	170	2.000	180	1.600	130
10,0	2.800	670	2.800	670	2.800	670	2.600	460	1.800	270	1.300	170	1.600	180	1.300	130
12,0	2.300	670	2.300	670	2.300	670	2.200	460	1.500	270	1.100	170	1.300	180	1.100	130
16,0	1.700	550	1.700	550	1.700	550	1.600	370	1.100	230	800	140	1.000	150	800	100
20,0	1.350	490	1.350	490	1.350	490	1.300	330	900	210	650	120	800	130	650	90
Shoulder cutting	ap	1,5 DC						1,0 DC						ap		
	ae	0,05 DC						0,02 DC						ae		

## Grooving

Work Material Cond.	Structural Steel		Carbon Steel (150 to 250HB)		Cast Iron		Alloy Steel (25 to 35HRC)		Tempered Steel, Hardened Steel (35 to 45HRC)		Hardened Steel (45 to 55HRC)		Stainless Steel		Heat Resistant Steel, Titanium Alloy	
	Spindle Speed (rpm)	Feed Rate (mm/min)	Spindle Speed (rpm)	Feed Rate (mm/min)	Spindle Speed (rpm)	Feed Rate (mm/min)	Spindle Speed (rpm)	Feed Rate (mm/min)	Spindle Speed (rpm)	Feed Rate (mm/min)	Spindle Speed (rpm)	Feed Rate (mm/min)	Spindle Speed (rpm)	Feed Rate (mm/min)	Spindle Speed (rpm)	Feed Rate (mm/min)
1,0	19.600	240	19.600	300	19.600	300	18.300	210	12.700	130	9.000	80	11.000	65	4.500	25
2,0	11.200	320	11.200	410	11.200	410	10.500	280	7.300	170	5.300	100	6.400	85	2.650	35
4,0	6.400	450	6.400	550	6.400	550	6.000	370	4.200	230	3.000	140	3.600	100	1.500	50
6,0	4.600	540	4.600	670	4.600	670	4.300	460	3.000	270	2.200	170	2.650	130	1.150	55
8,0	3.400	540	3.400	670	3.400	670	3.200	460	2.200	270	1.600	170	2.000	130	800	55
10,0	2.800	540	2.800	670	2.800	670	2.600	460	1.800	270	1.300	170	1.600	130	650	55
12,0	2.300	540	2.300	670	2.300	670	2.200	460	1.500	270	1.100	170	1.300	130	500	55
16,0	1.700	440	1.700	550	1.700	550	1.600	370	1.100	230	800	140	1.000	110	400	45
20,0	1.350	390	1.350	490	1.350	490	1.300	330	900	210	650	120	800	90	320	40
Grooving	ap	0,2 DC		0,5 DC				0,05 DC				0,2 DC				
	ae															

● = Euro stock  
○ = Japan stock

Coated Carbide **GSX**  
Grades Coating

Structural Steel	Carbon Steel	Alloy Steel	Pre-hardened Steel	Tempered D2e Steel	Hardened Steel	Stainless Steel	Ti Alloy / Heat Resistant Alloy	Cast Iron	Al Alloy	Cu Alloy	Graphite
○	○	○	○	○	○	○	○	○	○	○	○

DC	Tolerance
D ≤ 3,0	0 - 0,015
3,0 < D ≤ 12	0 - 0,020
12,0 < D	0 - 0,030

Grade: ACF20

Endmills

Cat. No.	Stock	DC	APMX	LU	LF	DMM
GSX 30100C-2D	○	1,0	2,5	3,5	40	4
GSX 30150C-2D	●	1,5	3,8	4,8	40	4
GSX 30200C-2D	●	2,0	5,0	6,0	40	4
GSX 30250C-2D	●	2,5	6,3	7,3	40	4
GSX 30300C-2D	●	3,0	7,5	9,0	45	6
GSX 30400C-2D	●	4,0	11,0	12,5	45	6
GSX 30500C-2D	●	5,0	13,0	15,0	50	6
GSX 30600C-2D	●	6,0	13,0	-	50	6
GSX 30700C-2D	●	7,0	16,0	18,0	60	8
GSX 30800C-2D	●	8,0	19,0	-	60	8
GSX 30900C-2D	●	9,0	19,0	21,0	70	10
GSX 31000C-2D	●	10,0	22,0	-	70	10
GSX 31200C-2D	●	12,0	26,0	-	75	12
GSX 31600C-2D		16,0	32,0	-	90	16
GSX 32000C-2D		20,0	40,0	-	100	20

Endmill Identification (GSX MILL Series)

**GSX 3 0100 C - 2D**

Series Code No. of Teeth Diameter Cutting Edge Cutting Edge Length

S: Sharp Edge  
C: Gash Land Drilling

Recommended Cutting Conditions

- For stable machining performance use rigid, high-precision machines and holders.
- Use air blowing when dry machining.
- Use wet machining for stainless steel, heat resistant alloy, and titanium alloy applications.
- If the machine cannot achieve the recommended spindle speed, please use the max. spindle speed available.

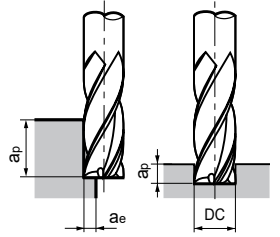

Shoulder Milling

Work Material Cond.	Structural Steel		Carbon Steel (150 to 250HB)		Cast Iron		Alloy Steel (25 to 35HRC)		Tempered Steel, Hardened Steel (35 to 45HRC)		Hardened Steel (45 to 55HRC)		Stainless Steel		Heat Resistant Steel, Titanium Alloy			
	Spindle Speed (rpm)	Feed Rate (mm/min)	Spindle Speed (rpm)	Feed Rate (mm/min)	Spindle Speed (rpm)	Feed Rate (mm/min)	Spindle Speed (rpm)	Feed Rate (mm/min)	Spindle Speed (rpm)	Feed Rate (mm/min)	Spindle Speed (rpm)	Feed Rate (mm/min)	Spindle Speed (rpm)	Feed Rate (mm/min)	Spindle Speed (rpm)	Feed Rate (mm/min)		
DC (mm) 1,0	19.600	300	19.600	300	19.600	300	18.300	210	12.700	130	9.000	80	11.000	90	9.000	65		
2,0	11.200	410	11.200	410	11.200	410	10.500	280	7.300	170	5.300	100	6.400	120	5.300	90		
4,0	6.400	550	6.400	550	6.400	550	6.000	370	4.200	230	3.000	140	3.600	150	3.000	120		
6,0	4.600	670	4.600	670	4.600	670	4.300	460	3.000	270	2.200	170	2.700	180	2.200	130		
8,0	3.400	670	3.400	670	3.400	670	3.200	460	2.200	270	1.600	170	2.000	180	1.600	130		
10,0	2.800	670	2.800	670	2.800	670	2.600	460	1.800	270	1.300	170	1.600	180	1.300	130		
12,0	2.300	670	2.300	670	2.300	670	2.200	460	1.500	270	1.100	170	1.300	180	1.100	130		
16,0	1.700	550	1.700	550	1.700	550	1.600	370	1.100	230	800	140	1.000	150	800	100		
20,0	1.350	490	1.350	490	1.350	490	1.300	330	900	210	650	120	800	130	650	90		
Shoulder cutting	ap		ae		1,5 DC				0,05 DC				1,0 DC				0,02 DC	

Grooving

Work Material Cond.	Structural Steel		Carbon Steel (150 to 250HB)		Cast Iron		Alloy Steel (25 to 35HRC)		Tempered Steel, Hardened Steel (35 to 45HRC)		Hardened Steel (45 to 55HRC)		Stainless Steel		Heat Resistant Steel, Titanium Alloy	
	Spindle Speed (rpm)	Feed Rate (mm/min)	Spindle Speed (rpm)	Feed Rate (mm/min)	Spindle Speed (rpm)	Feed Rate (mm/min)	Spindle Speed (rpm)	Feed Rate (mm/min)	Spindle Speed (rpm)	Feed Rate (mm/min)	Spindle Speed (rpm)	Feed Rate (mm/min)	Spindle Speed (rpm)	Feed Rate (mm/min)	Spindle Speed (rpm)	Feed Rate (mm/min)
DC (mm) 1,0	19.600	240	19.600	300	19.600	300	18.300	210	12.700	130	9.000	80	11.000	65	4.500	25
2,0	11.200	320	11.200	410	11.200	410	10.500	280	7.300	170	5.300	100	6.400	85	2.650	35
4,0	6.400	450	6.400	550	6.400	550	6.000	370	4.200	230	3.000	140	3.600	100	1.500	50
6,0	4.600	540	4.600	670	4.600	670	4.300	460	3.000	270	2.200	170	2.650	130	1.150	55
8,0	3.400	540	3.400	670	3.400	670	3.200	460	2.200	270	1.600	170	2.000	130	800	55
10,0	2.800	540	2.800	670	2.800	670	2.600	460	1.800	270	1.300	170	1.600	130	650	55
12,0	2.300	540	2.300	670	2.300	670	2.200	460	1.500	270	1.100	170	1.300	130	500	55
16,0	1.700	440	1.700	550	1.700	550	1.600	370	1.100	230	800	140	1.000	110	400	45
20,0	1.350	390	1.350	490	1.350	490	1.300	330	900	210	650	120	800	90	320	40
Grooving	ap		0,2 DC		0,5 DC				0,2 DC		0,05 DC		0,2 DC			

Coated Endmills

# GSX MILL Slot Endmills

## GSXSLT 30000C-1.5D Type

### 3 Slotted Short Endmills (3 Flutes)

For Compound Endmilling

Coated Carbide

Grades

Coating

Structural Steel	Carbon Steel	Alloy Steel	Pre-hardened Steel	Tempered Die Steel	Hardened Steel	Stainless Steel	Ti Alloy / Heat Resistant Alloy	Cast Iron	Al Alloy	Cu Alloy	Graphite
○	○	○	○	○	○	○	○	○	○	○	○

Helix Angle: 40°  
Corner: C Type

DC	Tolerance
D ≤ 3.0	0 - 0.015
3.0 < D ≤ 12	0 - 0.020
12.0 < D	0 - 0.030

Grade: ACF20

### Endmills

Cat. No.	Stock	(mm)				
		DC	APMX	LU	LF	DMM
GSXSLT 30100C-1.5D	●	1,0	1,5	2,5	40	4
GSXSLT 30150C-1.5D	●	1,5	2,3	3,3	40	4
GSXSLT 30200C-1.5D	○	2,0	3,0	4,0	40	4
GSXSLT 30250C-1.5D	○	2,5	3,8	4,8	40	4
GSXSLT 30300C-1.5D	●	3,0	4,5	6,0	45	6
GSXSLT 30400C-1.5D	●	4,0	6,0	7,5	45	6
GSXSLT 30500C-1.5D	●	5,0	7,5	9,5	50	6
GSXSLT 30600C-1.5D	●	6,0	9,0	-	50	6
GSXSLT 30700C-1.5D	●	7,0	11,0	13,0	60	8
GSXSLT 30800C-1.5D	●	8,0	12,0	-	60	8
GSXSLT 30900C-1.5D	●	9,0	14,0	16,0	70	10
GSXSLT 31000C-1.5D	●	10,0	15,0	-	70	10
GSXSLT 31200C-1.5D	●	12,0	18,0	-	75	12
GSXSLT 31600C-1.5D	●	16,0	24,0	-	90	16

### Recommended Cutting Conditions

- For stable machining performance use rigid, high-precision machines and holders.
- Use air blowing when dry machining.
- Use wet machining for stainless steel, heat resistant alloy, and titanium alloy applications.
- Use step machining of 0.1Dc when drilling stainless steel, heat resistant alloy, and titanium alloy.
- If the machine cannot achieve the recommended spindle speed, please use the max. spindle speed available.

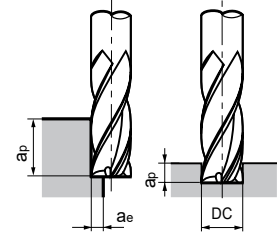

### Shoulder Milling

Work Material Cond.	Structural Steel		Carbon Steel (150 to 250HB)		Cast Iron		Alloy Steel (25 to 35HRC)		Tempered Steel, Hardened Steel (35 to 45HRC)		Hardened Steel (45 to 55HRC)		Stainless Steel		Heat Resistant Steel, Titanium Alloy	
	DC (mm)	Spindle Speed (rpm)	Feed Rate (mm/min)	Spindle Speed (rpm)	Feed Rate (mm/min)	Spindle Speed (rpm)	Feed Rate (mm/min)	Spindle Speed (rpm)	Feed Rate (mm/min)	Spindle Speed (rpm)	Feed Rate (mm/min)	Spindle Speed (rpm)	Feed Rate (mm/min)	Spindle Speed (rpm)	Feed Rate (mm/min)	Spindle Speed (rpm)
1,0	19.600	300	19.600	300	19.600	300	18.300	210	12.700	130	9.000	80	11.000	90	9.000	65
2,0	11.200	410	11.200	410	11.200	410	10.500	280	7.300	170	5.300	100	6.400	120	5.300	90
4,0	6.400	550	6.400	550	6.400	550	6.000	370	4.200	230	3.000	140	3.600	150	3.000	120
6,0	4.600	670	4.600	670	4.600	670	4.300	460	3.000	270	2.200	170	2.700	180	2.200	130
8,0	3.400	670	3.400	670	3.400	670	3.200	460	2.200	270	1.600	170	2.000	180	1.600	130
10,0	2.800	670	2.800	670	2.800	670	2.600	460	1.800	270	1.300	170	1.600	180	1.300	130
12,0	2.300	670	2.300	670	2.300	670	2.200	460	1.500	270	1.100	170	1.300	180	1.100	130
16,0	1.700	550	1.700	550	1.700	550	1.600	370	1.100	230	800	140	1.000	150	800	100
Shoulder cutting	1.5 DC											1.0 DC				
	0.05 DC											0.02 DC				

### Grooving

Work Material Cond.	Structural Steel		Carbon Steel (150 to 250HB)		Cast Iron		Alloy Steel (25 to 35HRC)		Tempered Steel, Hardened Steel (35 to 45HRC)		Hardened Steel (45 to 55HRC)		Stainless Steel		Heat Resistant Steel, Titanium Alloy	
	DC (mm)	Spindle Speed (rpm)	Feed Rate (mm/min)	Spindle Speed (rpm)	Feed Rate (mm/min)	Spindle Speed (rpm)	Feed Rate (mm/min)	Spindle Speed (rpm)	Feed Rate (mm/min)	Spindle Speed (rpm)	Feed Rate (mm/min)	Spindle Speed (rpm)	Feed Rate (mm/min)	Spindle Speed (rpm)	Feed Rate (mm/min)	Spindle Speed (rpm)
1,0	19.600	240	19.600	300	19.600	300	18.300	210	12.700	130	9.000	80	11.000	65	4.500	25
2,0	11.200	320	11.200	410	11.200	410	10.500	280	7.300	170	5.300	100	6.400	85	2.650	35
4,0	6.400	450	6.400	550	6.400	550	6.000	370	4.200	230	3.000	140	3.600	100	1.500	50
6,0	4.600	540	4.600	670	4.600	670	4.300	460	3.000	270	2.200	170	2.650	130	1.150	55
8,0	3.400	540	3.400	670	3.400	670	3.200	460	2.200	270	1.600	170	2.000	130	800	55
10,0	2.800	540	2.800	670	2.800	670	2.600	460	1.800	270	1.300	170	1.600	130	650	55
12,0	2.300	540	2.300	670	2.300	670	2.200	460	1.500	270	1.100	170	1.300	130	500	55
16,0	1.700	440	1.700	550	1.700	550	1.600	370	1.100	230	800	140	1.000	110	400	45
Grooving	0,2 DC		0,5 DC				0,2 DC		0,05 DC		0,2 DC					

### Drilling

Work Material Cond.	Structural Steel		Carbon Steel (150 to 250HB)		Cast Iron		Alloy Steel (25 to 35HRC)		Tempered Steel, Hardened Steel (35 to 45HRC)		Hardened Steel (45 to 55HRC)		Stainless Steel		Heat Resistant Steel, Titanium Alloy	
	DC (mm)	Spindle Speed (rpm)	Feed Rate (mm/min)	Spindle Speed (rpm)	Feed Rate (mm/min)	Spindle Speed (rpm)	Feed Rate (mm/min)	Spindle Speed (rpm)	Feed Rate (mm/min)	Spindle Speed (rpm)	Feed Rate (mm/min)	Spindle Speed (rpm)	Feed Rate (mm/min)	Spindle Speed (rpm)	Feed Rate (mm/min)	Spindle Speed (rpm)
1,0	19.600	70	19.600	90	19.600	90	18.300	60	12.700	40	9.000	25	11.000	20	4.500	10
2,0	11.200	90	11.200	120	11.200	120	10.500	80	7.300	50	5.300	30	6.400	25	2.650	15
4,0	6.400	130	6.400	160	6.400	160	6.000	110	4.200	70	3.000	40	3.600	30	1.500	20
6,0	4.600	160	4.600	200	4.600	200	4.300	130	3.000	80	2.200	50	2.650	40	1.150	20
8,0	3.400	160	3.400	200	3.400	200	3.200	130	2.200	80	1.600	50	2.000	40	800	20
10,0	2.800	160	2.800	200	2.800	200	2.600	130	1.800	80	1.300	50	1.600	40	650	20
12,0	2.300	160	2.300	200	2.300	200	2.200	130	1.500	80	1.100	50	1.300	40	500	20
16,0	1.700	130	1.700	160	1.700	160	1.600	110	1.100	70	800	40	1.000	35	400	15

**Coated Carbide** **GSX**  
Grades Coating

Structural Steel	Carbon Steel	Alloy Steel	Pre-hardened Steel	Tempered D2E Steel	Hardened Steel	Stainless Steel	Ti Alloy / Heat Resistant Alloy	Cast Iron	Al Alloy	Cu Alloy	Graphite
○	○	○	○	○	○	○	○	○	○	○	○

Helix Angle: 30°  
Corner: C Type

DC	Tolerance
D ≤ 3,0	0 - 0,015
3,0 < D ≤ 12	0 - 0,020
12,0 < D	0 - 0,030

Grade: ACF20

Endmills

Cat. No.	Stock	DC	APMX	LU	LF	DMM
GSX 40100C-1.5D	●	1,0	1,5	2,5	40	4
GSX 40150C-1.5D	●	1,5	2,3	3,3	40	4
GSX 40200C-1.5D	●	2,0	3,0	4,0	40	4
GSX 40250C-1.5D	●	2,5	3,8	4,8	40	4
GSX 40300C-1.5D	●	3,0	4,5	6,0	45	6
GSX 40350C-1.5D	●	3,5	5,3	6,8	45	6
GSX 40400C-1.5D	●	4,0	6,0	7,5	45	6
GSX 40450C-1.5D	●	4,5	6,8	8,3	50	6
GSX 40500C-1.5D	●	5,0	7,5	9,5	50	6
GSX 40550C-1.5D	○	5,5	8,3	10,3	50	6
GSX 40600C-1.5D	●	6,0	9,0	-	50	6
GSX 40700C-1.5D	●	7,0	11,0	13,0	60	8
GSX 40800C-1.5D	●	8,0	12,0	-	60	8
GSX 40900C-1.5D	●	9,0	14,0	16,0	70	10
GSX 41000C-1.5D	●	10,0	15,0	-	70	10
GSX 41200C-1.5D	●	12,0	18,0	-	75	12
GSX 41400C-1.5D	○	14,0	21,0	24,5	90	16
GSX 41500C-1.5D	○	15,0	23,0	26,5	90	16
GSX 41600C-1.5D	○	16,0	24,0	-	90	16
GSX 42000C-1.5D	○	20,0	30,0	-	100	20

Recommended Cutting Conditions

- For stable machining performance use rigid, high-precision machines and holders.
- Use air blowing when dry machining.
- Use wet machining for stainless steel, heat resistant alloy, and titanium alloy applications.
- If the machine cannot achieve the recommended spindle speed, please use the max. spindle speed available.

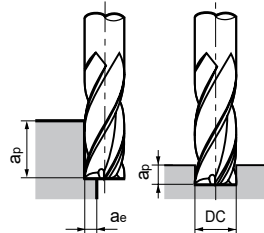

Shoulder Milling

Work Material	Structural Steel		Carbon Steel (150 to 250HB)		Cast Iron		Alloy Steel (25 to 35HRC)		Tempered Steel, Hardened Steel (35 to 45HRC)		Hardened Steel (45 to 55HRC)		Stainless Steel		Heat Resistant Steel, Titanium Alloy	
	Spindle Speed (rpm)	Feed Rate (mm/min)	Spindle Speed (rpm)	Feed Rate (mm/min)	Spindle Speed (rpm)	Feed Rate (mm/min)	Spindle Speed (rpm)	Feed Rate (mm/min)	Spindle Speed (rpm)	Feed Rate (mm/min)	Spindle Speed (rpm)	Feed Rate (mm/min)	Spindle Speed (rpm)	Feed Rate (mm/min)	Spindle Speed (rpm)	Feed Rate (mm/min)
DC (mm)																
1,0	24.000	470	24.000	470	24.000	470	21.000	290	14.500	180	10.500	120	12.600	120	10.500	85
2,0	12.800	570	12.800	570	12.800	570	12.000	380	8.300	230	6.000	150	7.200	160	6.000	110
4,0	6.800	730	6.800	730	6.800	730	6.400	490	4.400	300	3.200	200	3.800	210	3.200	130
6,0	4.600	780	4.600	780	4.600	780	4.300	520	3.000	320	2.200	210	2.650	220	2.200	150
8,0	3.400	780	3.400	780	3.400	780	3.200	520	2.200	320	1.600	210	2.000	220	1.600	150
10,0	2.800	780	2.800	780	2.800	780	2.600	520	1.800	320	1.300	210	1.500	220	1.300	150
12,0	2.300	780	2.300	780	2.300	780	2.200	520	1.500	320	1.100	210	1.300	220	1.100	150
16,0	1.700	650	1.700	650	1.700	650	1.600	420	1.100	280	800	170	1.000	180	800	120
20,0	1.350	600	1.350	600	1.350	600	1.300	380	900	260	650	150	800	160	650	100
Shoulder cutting	ap															
	ae															

Shoulder Milling (High Speed Machining Centre)

Work Material	Structural Steel		Carbon Steel (150 to 250HB)		Cast Iron		Alloy Steel (25 to 35HRC)		Tempered Steel, Hardened Steel (35 to 45HRC)		Hardened Steel (45 to 55HRC)		Stainless Steel		Heat Resistant Steel, Titanium Alloy	
	Spindle Speed (rpm)	Feed Rate (mm/min)	Spindle Speed (rpm)	Feed Rate (mm/min)	Spindle Speed (rpm)	Feed Rate (mm/min)	Spindle Speed (rpm)	Feed Rate (mm/min)	Spindle Speed (rpm)	Feed Rate (mm/min)	Spindle Speed (rpm)	Feed Rate (mm/min)	Spindle Speed (rpm)	Feed Rate (mm/min)	Spindle Speed (rpm)	Feed Rate (mm/min)
DC (mm)																
1,0	60.000	1.200	60.000	1.200	60.000	1.200	60.000	850	60.000	720	48.000	500	32.000	300	-	-
2,0	47.800	2.200	47.800	2.200	47.800	2.200	47.800	1.600	39.800	1.200	31.800	900	15.900	400	-	-
4,0	23.900	2.600	23.900	2.600	23.900	2.600	23.900	1.900	19.900	1.400	15.900	1.100	8.000	490	-	-
6,0	16.000	2.700	16.000	2.700	16.000	2.700	16.000	2.000	13.300	1.500	10.600	1.200	5.300	520	-	-
8,0	12.000	2.700	12.000	2.700	12.000	2.700	12.000	2.000	10.000	1.500	8.000	1.200	4.000	520	-	-
10,0	9.600	2.700	9.600	2.700	9.600	2.700	9.600	2.000	8.000	1.500	6.400	1.200	3.200	520	-	-
12,0	8.000	2.700	8.000	2.700	8.000	2.700	8.000	2.000	6.700	1.500	5.300	1.200	2.700	520	-	-
16,0	6.000	2.200	6.000	2.200	6.000	2.200	6.000	1.600	5.000	1.200	4.000	900	2.000	450	-	-
20,0	4.800	2.000	4.800	2.000	4.800	2.000	4.800	1.400	4.000	1.100	3.200	750	1.600	380	-	-
Shoulder cutting	ap															
	ae															

Grooving

Work Material	Structural Steel		Carbon Steel (150 to 250HB)		Cast Iron		Alloy Steel (25 to 35HRC)		Tempered Steel, Hardened Steel (35 to 45HRC)		Hardened Steel (45 to 55HRC)		Stainless Steel		Heat Resistant Steel, Titanium Alloy	
	Spindle Speed (rpm)	Feed Rate (mm/min)	Spindle Speed (rpm)	Feed Rate (mm/min)	Spindle Speed (rpm)	Feed Rate (mm/min)	Spindle Speed (rpm)	Feed Rate (mm/min)	Spindle Speed (rpm)	Feed Rate (mm/min)	Spindle Speed (rpm)	Feed Rate (mm/min)	Spindle Speed (rpm)	Feed Rate (mm/min)	Spindle Speed (rpm)	Feed Rate (mm/min)
DC (mm)																
1,0	24.000	380	24.000	470	24.000	470	21.000	290	14.500	180	10.500	120	12.600	85	5.200	30
2,0	12.800	460	12.800	570	12.800	570	12.000	380	8.300	230	6.000	150	7.200	110	3.000	40
4,0	6.800	580	6.800	730	6.800	730	5.400	490	4.400	300	3.200	200	3.800	130	1.600	55
6,0	4.600	620	4.600	780	4.600	780	4.300	520	3.000	320	2.200	210	2.650	160	1.100	65
8,0	3.400	620	3.400	780	3.400	780	3.200	520	2.200	320	1.600	210	2.000	160	800	65
10,0	2.800	620	2.800	780	2.800	780	2.600	520	1.800	320	1.300	210	1.600	160	650	65
12,0	2.300	620	2.300	780	2.300	780	2.200	520	1.500	320	1.100	210	1.300	160	550	65
16,0	1.700	520	1.700	560	1.700	560	1.600	420	1.100	280	800	170	1.000	130	400	55
20,0	1.350	480	1.350	600	1.350	600	1.300	380	900	260	650	150	800	110	320	50
Grooving	ap															





Coated Carbide Grades	GSX Coating	Structural Steel	Carbon Steel	Alloy Steel	Pre-hardened Steel	Tempered D2E Steel	Hardened Steel	Stainless Steel	Ti Alloy / Heat Resistant Alloy	Cast Iron	Al Alloy	Cu Alloy	Graphite
		○	○	○	○	○	○	○	○	○	○	○	○

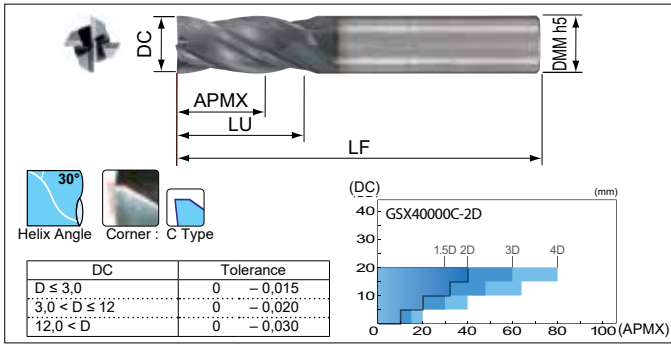

Recommended Cutting Conditions

- For stable machining performance use rigid, high-precision machines and holders.
- Use air blowing when dry machining.
- Use wet machining for stainless steel, heat resistant alloy, and titanium alloy applications.
- If chattering is a problem, reduce the spindle speed and feed rate indicated in the table below by the same ratio, or reduce the depth of cut.
- If the machine cannot achieve the recommended spindle speed, please use the max. spindle speed available.

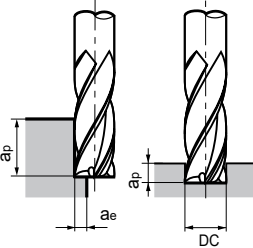

Endmills

Cat. No.	Stock	DC	APMX	LU	LF	DMM
GSX 40100C-2D	●	1,0	2,0	3,0	40	4
GSX 40150C-2D	●	1,5	3,0	4,0	40	4
GSX 40200C-2D	●	2,0	4,0	5,0	40	4
GSX 40250C-2D	●	2,5	5,0	6,0	40	4
GSX 40300C-2D	●	3,0	6,0	7,5	45	6
GSX 40350C-2D	○	3,5	7,0	8,5	45	6
GSX 40400C-2D	●	4,0	8,0	9,5	45	6
GSX 40450C-2D	●	4,5	9,0	10,5	50	6
GSX 40500C-2D	●	5,0	10,0	12,0	50	6
GSX 40550C-2D	●	5,5	11,0	13,0	50	6
GSX 40600C-2D	●	6,0	12,0	-	50	6
GSX 40700C-2D	●	7,0	14,0	16,0	60	8
GSX 40800C-2D	●	8,0	16,0	-	60	8
GSX 40900C-2D	●	9,0	18,0	20,0	70	10
GSX 41000C-2D	●	10,0	20,0	-	70	10
GSX 41200C-2D	●	12,0	24,0	-	75	12
GSX 41400C-2D	○	14,0	28,0	31,5	90	16
GSX 41500C-2D	●	15,0	30,0	33,5	90	16
GSX 41600C-2D	●	16,0	32,0	-	90	16
GSX 42000C-2D	●	20,0	40,0	-	100	20

Shoulder Milling

Work Material Cond.	Structural Steel		Carbon Steel (150 to 250HB)		Cast Iron		Alloy Steel (25 to 35HRC)		Tempered Steel, Hardened Steel (35 to 45HRC)		Hardened Steel (45 to 55HRC)		Stainless Steel		Heat Resistant Steel, Titanium Alloy	
	Spindle Speed (rpm)	Feed Rate (mm/min)	Spindle Speed (rpm)	Feed Rate (mm/min)	Spindle Speed (rpm)	Feed Rate (mm/min)	Spindle Speed (rpm)	Feed Rate (mm/min)	Spindle Speed (rpm)	Feed Rate (mm/min)	Spindle Speed (rpm)	Feed Rate (mm/min)	Spindle Speed (rpm)	Feed Rate (mm/min)	Spindle Speed (rpm)	Feed Rate (mm/min)
DC (mm)																
1,0	24.000	470	24.000	470	24.000	470	21.000	290	14.500	180	10.500	120	12.600	120	10.500	85
2,0	12.800	570	12.800	570	12.800	570	12.000	380	8.300	230	6.000	150	7.200	160	6.000	110
4,0	6.800	730	6.800	730	6.800	730	6.400	490	4.400	300	3.200	200	3.800	210	3.200	130
6,0	4.600	780	4.600	780	4.600	780	4.300	520	3.000	320	2.200	210	2.650	220	2.200	150
8,0	3.400	780	3.400	780	3.400	780	3.200	520	2.200	320	1.600	210	2.000	220	1.600	150
10,0	2.800	780	2.800	780	2.800	780	2.600	520	1.800	320	1.300	210	1.500	220	1.300	150
12,0	2.300	780	2.300	780	2.300	780	2.200	520	1.500	320	1.100	210	1.300	220	1.100	150
16,0	1.700	650	1.700	650	1.700	650	1.600	420	1.100	280	800	170	1.000	180	800	120
20,0	1.350	600	1.350	600	1.350	600	1.300	380	900	260	650	150	800	160	650	100
Shoulder cutting	ap		1,5 DC										1,0 DC			
	ae		0,05 DC										0,02 DC			

Shoulder Milling (High Speed Machining Centre)

Work Material Cond.	Structural Steel		Carbon Steel (150 to 250HB)		Cast Iron		Alloy Steel (25 to 35HRC)		Tempered Steel, Hardened Steel (35 to 45HRC)		Hardened Steel (45 to 55HRC)		Stainless Steel		Heat Resistant Steel, Titanium Alloy	
	Spindle Speed (rpm)	Feed Rate (mm/min)	Spindle Speed (rpm)	Feed Rate (mm/min)	Spindle Speed (rpm)	Feed Rate (mm/min)	Spindle Speed (rpm)	Feed Rate (mm/min)	Spindle Speed (rpm)	Feed Rate (mm/min)	Spindle Speed (rpm)	Feed Rate (mm/min)	Spindle Speed (rpm)	Feed Rate (mm/min)	Spindle Speed (rpm)	Feed Rate (mm/min)
DC (mm)																
1,0	60.000	1.200	60.000	1.200	60.000	1.200	60.000	850	60.000	720	48.000	500	32.000	300	-	-
2,0	47.800	2.200	47.800	2.200	47.800	2.200	47.800	1.600	39.800	1.200	31.800	900	15.900	400	-	-
4,0	23.900	2.600	23.900	2.600	23.900	2.600	23.900	1.900	19.900	1.400	15.900	1.100	8.000	490	-	-
6,0	16.000	2.700	16.000	2.700	16.000	2.700	16.000	2.000	13.300	1.500	10.600	1.200	5.300	520	-	-
8,0	12.000	2.700	12.000	2.700	12.000	2.700	12.000	2.000	10.000	1.500	8.000	1.200	4.000	520	-	-
10,0	9.600	2.700	9.600	2.700	9.600	2.700	9.600	2.000	8.000	1.500	6.400	1.200	3.200	520	-	-
12,0	8.000	2.700	8.000	2.700	8.000	2.700	8.000	2.000	6.700	1.500	5.300	1.200	2.700	520	-	-
16,0	6.000	2.200	6.000	2.200	6.000	2.200	6.000	1.600	5.000	1.200	4.000	900	2.000	450	-	-
20,0	4.800	2.000	4.800	2.000	4.800	2.000	4.800	1.400	4.000	1.100	3.200	750	1.600	380	-	-
Shoulder cutting	ap		1,5 DC										1,0 DC			
	ae		0,05 DC										0,02 DC			

Grooving

Work Material Cond.	Structural Steel		Carbon Steel (150 to 250HB)		Cast Iron		Alloy Steel (25 to 35HRC)		Tempered Steel, Hardened Steel (35 to 45HRC)		Hardened Steel (45 to 55HRC)		Stainless Steel		Heat Resistant Steel, Titanium Alloy	
	Spindle Speed (rpm)	Feed Rate (mm/min)	Spindle Speed (rpm)	Feed Rate (mm/min)	Spindle Speed (rpm)	Feed Rate (mm/min)	Spindle Speed (rpm)	Feed Rate (mm/min)	Spindle Speed (rpm)	Feed Rate (mm/min)	Spindle Speed (rpm)	Feed Rate (mm/min)	Spindle Speed (rpm)	Feed Rate (mm/min)	Spindle Speed (rpm)	Feed Rate (mm/min)
DC (mm)																
1,0	24.000	380	24.000	470	24.000	470	21.000	290	14.500	180	10.500	120	12.600	85	5.200	30
2,0	12.800	460	12.800	570	12.800	570	12.000	380	8.300	230	6.000	150	7.200	110	3.000	40
4,0	6.800	580	6.800	730	6.800	730	6.400	490	4.400	300	3.200	200	3.800	130	1.600	55
6,0	4.600	620	4.600	780	4.600	780	4.300	520	3.000	320	2.200	210	2.650	160	1.100	65
8,0	3.400	620	3.400	780	3.400	780	3.200	520	2.200	320	1.600	210	2.000	160	800	65
10,0	2.800	620	2.800	780	2.800	780	2.600	520	1.800	320	1.300	210	1.600	160	650	65
12,0	2.300	620	2.300	780	2.300	780	2.200	520	1.500	320	1.100	210	1.300	160	550	65
16,0	1.700	520	1.700	560	1.700	560	1.600	420	1.100	280	800	170	1.000	130	400	55
20,0	1.350	480	1.350	600	1.350	600	1.300	380	900	260	650	150	800	110	320	50
Grooving	ap		0,2 DC				0,5 DC				0,2 DC		0,05 DC		0,2 DC	

Coated Endmills



# GSX 40000C-3D Type

Coated Carbide

Grades

Coating

Structural Steel	Carbon Steel	Alloy Steel	Pre-hardened Steel	Tempered Die Steel	Hardened Steel	Stainless Steel	Ti Alloy / Heat Resistant Alloy	Cast Iron	Al Alloy	Cu Alloy	Graphite
○	○	○	○	○	45-55 HRC	55-60 HRC	60-65 HRC	○	○	○	○

Helix Angle: 30°  
Corner: C Type

DC	Tolerance
D ≤ 3.0	0 -0.015
3.0 < D ≤ 12	0 -0.020
12.0 < D	0 -0.030

Grade: ACF20

## Endmills

Cat. No.	Stock	(mm)				
		DC	APMX	LU	LF	DMM
GSX 40100C-3D	○	1,0	3,0	4,0	40	4
GSX 40150C-3D	●	1,5	4,5	5,5	40	4
GSX 40200C-3D	●	2,0	6,0	7,0	40	4
GSX 40250C-3D	○	2,5	7,5	8,5	40	4
GSX 40300C-3D	●	3,0	9,0	10,5	50	6
GSX 40400C-3D	●	4,0	12,0	13,5	50	6
GSX 40500C-3D	●	5,0	15,0	17,0	50	6
GSX 40600C-3D	●	6,0	18,0	-	50	6
GSX 40800C-3D	●	8,0	24,0	-	70	8
GSX 41000C-3D	●	10,0	30,0	-	90	10
GSX 41200C-3D	●	12,0	36,0	-	90	12
GSX 41600C-3D	●	16,0	48,0	-	110	16
GSX 42000C-3D	○	20,0	60,0	-	120	20

## Endmill Identification (GSX MILL Series)

# GSX 4 0100 C - 2D / 3D

Series Code    No. of Teeth    Diameter    Cutting Edge    Cutting Edge Length

S: Sharp Edge  
C: Gash Land Drilling

## Recommended Cutting Conditions

- For stable machining performance use rigid, high-precision machines and holders.
- Use air blowing when dry machining.
- Use wet machining for stainless steel, heat resistant alloy, and titanium alloy applications.
- In rear cases, chattering may occur in early milling stages, dissipating after 2 m of cutting.
- If chattering is a problem, reduce the spindle speed and feed rate indicated in the table below by the same ratio, or reduce the depth of cut.
- If the machine cannot achieve the recommended spindle speed, please use the max. spindle speed available.

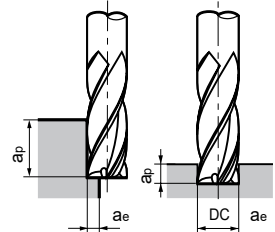

## Shoulder Milling

Work Material	Structural Steel		Carbon Steel (150 to 250HB)		Cast Iron		Alloy Steel (25 to 35HRC)		Tempered Steel, Hardened Steel (35 to 45HRC)		Hardened Steel (45 to 55HRC)		Stainless Steel		Heat Resistant Steel, Titanium Alloy	
	Cond.	Spindle Speed (rpm)	Feed Rate (mm/min)	Spindle Speed (rpm)	Feed Rate (mm/min)	Spindle Speed (rpm)	Feed Rate (mm/min)	Spindle Speed (rpm)	Feed Rate (mm/min)	Spindle Speed (rpm)	Feed Rate (mm/min)	Spindle Speed (rpm)	Feed Rate (mm/min)	Spindle Speed (rpm)	Feed Rate (mm/min)	Spindle Speed (rpm)
1,0	21.000	360	21.000	360	21.000	360	19.000	220	13.000	140	9.000	90	10.500	90	9.000	65
2,0	10.500	360	10.500	360	10.500	360	9.600	290	7.500	180	4.500	110	5.200	120	4.500	85
4,0	5.200	500	5.200	500	5.200	500	4.800	370	4.000	280	2.250	150	2.600	160	2.250	100
6,0	3.500	560	3.500	560	3.500	560	3.200	400	2.700	300	1.500	160	1.700	170	1.500	120
8,0	2.600	520	2.600	520	2.600	520	2.400	400	2.000	300	1.100	160	1.300	170	1.100	120
10,0	2.100	500	2.100	500	2.100	500	1.900	400	1.600	300	900	160	1.000	160	900	120
12,0	1.750	500	1.750	500	1.750	500	1.600	400	1.350	300	750	150	850	160	750	120
16,0	1.300	420	1.300	420	1.300	420	1.200	330	1.000	260	550	120	650	140	550	100
20,0	1.050	380	1.050	380	1.050	380	950	290	800	230	450	110	500	120	450	90
Shoulder cutting	2,5 DC										2,0 DC					
	$< \phi 3: 0,05 DC$ , $\le \phi 3 < \phi 8: 0,1 DC$ , $\le \phi 8: 0,15 DC$										0,02 DC					

## Grooving

Work Material	Structural Steel		Carbon Steel (150 to 250HB)		Cast Iron		Alloy Steel (25 to 35HRC)		Tempered Steel, Hardened Steel (35 to 45HRC)		Hardened Steel (45 to 55HRC)		Stainless Steel		Heat Resistant Steel, Titanium Alloy	
	Cond.	Spindle Speed (rpm)	Feed Rate (mm/min)	Spindle Speed (rpm)	Feed Rate (mm/min)	Spindle Speed (rpm)	Feed Rate (mm/min)	Spindle Speed (rpm)	Feed Rate (mm/min)	Spindle Speed (rpm)	Feed Rate (mm/min)	Spindle Speed (rpm)	Feed Rate (mm/min)	Spindle Speed (rpm)	Feed Rate (mm/min)	Spindle Speed (rpm)
1,0	16.600	140	16.600	140	16.600	140	15.500	100	10.500	100	7.500	70	9.400	60	3.750	20
2,0	9.500	160	9.500	160	9.500	160	9.000	180	6.200	120	4.500	90	5.200	80	2.250	30
4,0	5.200	160	5.200	180	5.200	180	4.800	160	3.400	110	2.200	65	2.600	70	1.250	25
6,0	3.500	160	3.500	200	3.500	200	3.200	160	2.550	120	1.500	65	1.700	70	950	25
8,0	2.600	160	2.600	200	2.600	200	2.400	160	1.900	120	1.100	65	1.300	70	700	25
10,0	2.100	160	2.100	200	2.100	200	1.900	160	1.500	120	900	65	1.000	70	550	25
12,0	1.750	160	1.750	200	1.750	200	1.600	160	1.250	120	750	65	850	70	450	25
16,0	1.300	160	1.300	200	1.300	200	1.200	160	950	120	550	65	650	70	350	25
20,0	1.050	160	1.050	200	1.050	200	950	160	750	120	450	65	500	70	280	25
Grooving	0,1 DC		0,2 DC				0,05 DC				0,1 DC					

Coated Carbide **GSX**  
 Grades Coating

Structural Steel	Carbon Steel	Alloy Steel	Pre-hardened Steel	Tempered D2E Steel	Hardened Steel	Stainless Steel	Ti Alloy / Heat Resistant Alloy	Cast Iron	Al Alloy	Cu Alloy	Graphite
○	○	○	○	○	○	○	○	○	○	○	○

DC	Tolerance
D ≤ 3,0	0 - 0,015
3,0 < D ≤ 12	0 - 0,020
12,0 < D	0 - 0,030

Grade: ACF20

■ Endmills

Cat. No.	Stock	DC	APMX	LU	LF	DMM
GSX 40100C-4D	●	1,0	4,0	5,0	40	4
GSX 40150C-4D	●	1,5	6,0	7,0	40	4
GSX 40200C-4D	●	2,0	8,0	9,0	40	4
GSX 40250C-4D	●	2,5	10,0	11,0	50	4
GSX 40300C-4D	●	3,0	12,0	13,5	50	6
GSX 40400C-4D	●	4,0	16,0	17,5	50	6
GSX 40500C-4D	●	5,0	20,0	22,0	60	6
GSX 40600C-4D	●	6,0	24,0	-	60	6
GSX 40800C-4D	●	8,0	32,0	-	80	8
GSX 41000C-4D	●	10,0	40,0	-	90	10
GSX 41200C-4D	●	12,0	48,0	-	100	12
GSX 41600C-4D	●	16,0	64,0	-	120	16
GSX 42000C-4D	○	20,0	80,0	-	140	20

■ Endmill Identification (GSX MILL Series)

**GSX 4 0100 C - 4D**

Series Code    No. of Teeth    Diameter    Cutting Edge    Cutting Edge Length

S: Sharp Edge  
 C: Gash Land Drilling

■ Recommended Cutting Conditions

1. For stable machining performance use rigid, high-precision machines and holders.
2. Use air blowing when dry machining.
3. Use wet machining for stainless steel, heat resistant alloy, and titanium alloy applications.
4. In rear cases, chattering may occur in early milling stages, dissipating after 2m of cutting.
5. If chattering is a problem, reduce the spindle speed and feed rate indicated in the table below by the same ratio, or reduce the depth of cut.
6. This series is not recommended for grooving.
7. If the machine cannot achieve the recommended spindle speed, please use the max. spindle speed available.

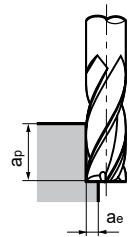

● Shoulder Milling

Work Material	Structural Steel		Carbon Steel (150 to 250HB)		Cast Iron		Alloy Steel (25 to 35HRC)		Tempered Steel, Hardened Steel (35 to 45HRC)		Hardened Steel (45 to 55HRC)		Stainless Steel		Heat Resistant Steel, Titanium Alloy	
	Spindle Speed (rpm)	Feed Rate (mm/min)	Spindle Speed (rpm)	Feed Rate (mm/min)	Spindle Speed (rpm)	Feed Rate (mm/min)	Spindle Speed (rpm)	Feed Rate (mm/min)	Spindle Speed (rpm)	Feed Rate (mm/min)	Spindle Speed (rpm)	Feed Rate (mm/min)	Spindle Speed (rpm)	Feed Rate (mm/min)	Spindle Speed (rpm)	Feed Rate (mm/min)
1,0	9.000	140	9.000	140	9.000	140	7.000	80	6.500	60	4.500	40	5.400	40	4.500	40
2,0	4.500	140	4.500	140	4.500	140	3.500	100	3.200	80	2.300	55	2.700	55	2.300	40
4,0	2.250	200	2.250	200	2.250	200	1.750	120	1.600	100	1.200	60	1.350	50	1.200	35
6,0	1.500	250	1.500	250	1.500	250	1.150	160	1.050	140	800	65	900	45	800	35
8,0	1.100	220	1.100	220	1.100	220	850	160	800	130	600	65	660	45	600	35
10,0	900	210	900	210	900	210	700	140	650	120	460	65	540	45	460	35
12,0	750	200	750	200	750	200	580	140	520	110	400	65	450	45	400	35
16,0	550	170	550	170	550	170	440	120	400	95	300	55	330	45	300	35
20,0	450	150	450	150	450	150	350	100	320	80	240	50	270	45	240	35
Shoulder cutting	ap	3,5 DC										3,0 DC				
	ae	<math>\phi 3: 0,04 DC, 3 \le \phi D < 8: 0,08 DC, 8 \le \phi D: 0,1 DC</math>										0,02 DC				

# Anti-Vibration Typ GSX MILL

## GSXVL 4000-2.5D Type

### SAFE-LOCK™ Applicable Endmills (4 Flutes)



Structural Steel	Carbon Steel	Alloy Steel	Pre-hardened Steel	Tempered Die Steel	Hardened Steel	Stainless Steel	Ti Alloy / Heat Resistant Alloy	Cast Iron	Al Alloy	Cu Alloy	Graphite
○	○	○	○	○	○	○	○	○	○	○	○

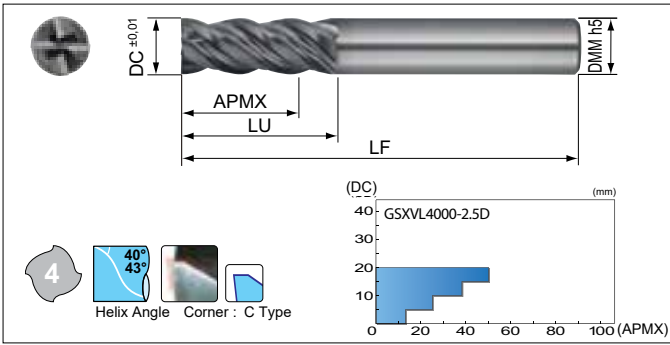

### Endmills

Cat. No.	Stock	DC	APMX	LU	LF	DMM
GSXVL 4020-2.5D	●	2,0	5	6,5	50	4
GSXVL 4030-2.5D	●	3,0	8	9,5	50	6
GSXVL 4040-2.5D	●	4,0	10	11,5	50	6
GSXVL 4050-2.5D	●	5,0	13	14,5	60	6
GSXVL 4060-2.5D	●	6,0	15	-	60	6
GSXVL 4070-2.5D	○	7,0	18	20,0	70	8
GSXVL 4080-2.5D	●	8,0	20	-	80	8
GSXVL 4090-2.5D	●	9,0	23	25,0	90	10
GSXVL 4100-2.5D	●	10,0	25	-	90	10
GSXVL 4110-2.5D	●	11,0	28	30,5	90	12
GSXVL 4120-2.5D	●	12,0	30	-	90	12
GSXVL 4140-2.5D	●	14,0	35	37,5	110	16
GSXVL 4150-2.5D	●	15,0	38	41,0	110	16
GSXVL 4160-2.5D	●	16,0	40	-	115	16
GSXVL 4180-2.5D	●	18,0	45	48,0	120	20
GSXVL 4200-2.5D	●	20,0	50	-	125	20
GSXVL 4250-2.5D	○	25,0	63	-	140	25

### SAFE-LOCK™ Applicable Endmills

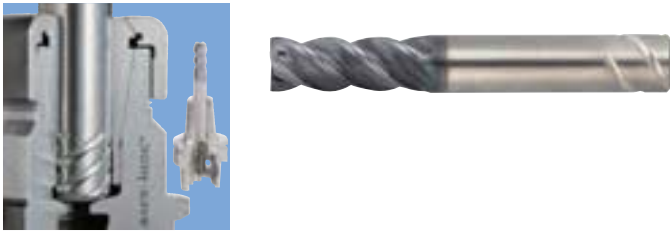

### Endmills

Cat. No.	Stock	DC	APMX	LU	LF	DMM
GSXVL 4120S-2.5D	○	12,0	30	-	90	12
GSXVL 4140S-2.5D	○	14,0	35	37,5	110	16
GSXVL 4150S-2.5D	○	15,0	38	41,0	110	16
GSXVL 4160S-2.5D	○	16,0	40	-	115	16
GSXVL 4180S-2.5D	○	18,0	45	48,0	120	20
GSXVL 4200S-2.5D	○	20,0	50	-	125	20
GSXVL 4250S-2.5D	○	25,0	63	-	140	25

### Recommended Cutting Conditions

1. For stable machining performance use rigid, high-precision machines and holders.
2. Use air blowing when dry machining.
3. Use wet machining for stainless steel, heat resistant alloy, and titanium alloy applications.
4. If the machine cannot achieve the recommended spindle speed, please use the max. spindle speed available.

### Shoulder Milling

Work Material Cond.	Carbon Steel, Cast Iron (150 to 250HB)		Alloy Steel (25 to 35HRC)		Tempered Steel, Hardened Steel (40 to 50HRC)		Stainless Steel		Heat Resistant Steel, Titanium Alloy (20 to 45HRC)	
	Spindle Speed (rpm)	Feed Rate (mm/min)	Spindle Speed (rpm)	Feed Rate (mm/min)	Spindle Speed (rpm)	Feed Rate (mm/min)	Spindle Speed (rpm)	Feed Rate (mm/min)	Spindle Speed (rpm)	Feed Rate (mm/min)
DC (mm)										
2,0	13.000	1.000	10.000	800	8.000	700	10.000	580	5.000	200
4,0	9.600	1.200	8.000	1.000	6.000	800	5.500	650	3.000	230
6,0	6.800	1.500	5.600	1.200	4.200	900	3.800	680	2.100	240
8,0	5.200	1.600	4.400	1.300	3.200	950	2.800	650	1.600	250
10,0	4.200	1.500	3.500	1.200	2.600	800	2.300	600	1.300	210
12,0	3.500	1.400	3.000	1.200	2.200	700	1.900	550	1.100	180
14,0	3.000	1.200	2.600	1.100	1.800	600	1.600	500	900	150
16,0	2.700	1.100	2.200	1.000	1.600	600	1.400	480	760	130
18,0	2.400	1.000	2.000	900	1.400	570	1.300	450	680	120
20,0	2.200	900	1.700	800	1.200	550	1.100	400	600	100
25,0	1.700	680	1.400	630	1.000	450	890	310	480	82
Shoulder cutting	$a_p$		1,5 DC		0,05 DC		0,1 DC		0,05 DC	
	$a_e$		0,1 DC		0,05 DC		0,1 DC		0,05 DC	

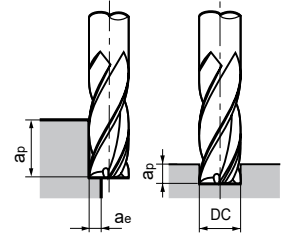

### Shoulder Milling

Work Material Cond.	Carbon Steel, Cast Iron (150 to 250HB)		Alloy Steel (25 to 35HRC)		Tempered Steel, Hardened Steel (40 to 50HRC)		Stainless Steel		Heat Resistant Steel, Titanium Alloy (20 to 45HRC)	
	Spindle Speed (rpm)	Feed Rate (mm/min)	Spindle Speed (rpm)	Feed Rate (mm/min)	Spindle Speed (rpm)	Feed Rate (mm/min)	Spindle Speed (rpm)	Feed Rate (mm/min)	Spindle Speed (rpm)	Feed Rate (mm/min)
DC (mm)										
2,0	13.000	750	10.000	550	8.400	500	6.500	300	4.000	140
4,0	8.200	800	6.000	600	5.200	500	4.000	330	2.000	130
6,0	6.100	1.100	4.000	600	3.500	580	2.700	350	1.350	150
8,0	4.600	1.000	3.000	580	2.600	570	2.000	330	1.000	140
10,0	3.600	1.000	2.400	550	2.100	510	1.600	200	800	130
12,0	3.100	920	2.000	500	1.700	450	1.300	280	660	110
14,0	2.600	750	1.700	450	1.500	400	1.100	250	570	100
16,0	2.300	670	1.500	420	1.300	350	1.000	230	500	90
18,0	2.000	620	1.300	380	1.100	330	900	200	430	80
20,0	1.900	600	1.200	360	1.000	320	800	180	380	70
25,0	1.500	470	1.000	300	790	250	640	140	300	55
Grooving	$a_p$		1,0 DC		0,2 DC		0,3 DC		0,2 DC	

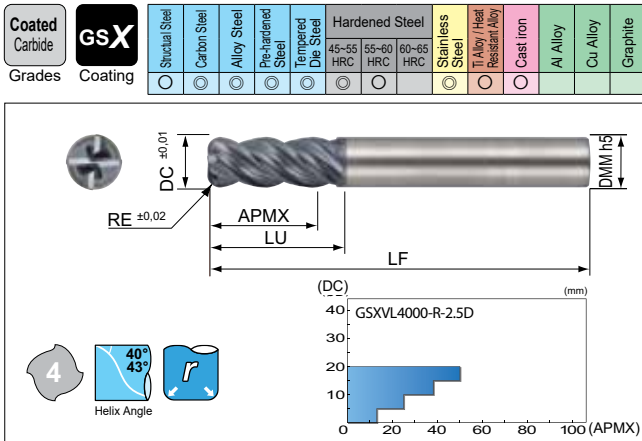

**Endmills** (mm)

Cat. No.	Stock	DC	RE	APMX	LU	LF	DMM
GSXVL 4030-R02-2.5D	●	3,0	0,2	8	9,5	50	6
GSXVL 4030-R05-2.5D	●	3,0	0,5	8	9,5	50	6
GSXVL 4040-R02-2.5D	○	4,0	0,2	10	11,5	50	6
GSXVL 4040-R05-2.5D	○	4,0	0,5	10	11,5	50	6
GSXVL 4040-R10-2.5D	○	4,0	1,0	10	11,5	50	6
GSXVL 4050-R02-2.5D	●	5,0	0,2	13	14,5	60	6
GSXVL 4050-R05-2.5D	●	5,0	0,5	13	14,5	60	6
GSXVL 4050-R10-2.5D	●	5,0	1,0	13	14,5	60	6
GSXVL 4060-R03-2.5D	○	6,0	0,3	15	—	60	6
GSXVL 4060-R05-2.5D	●	6,0	0,5	15	—	60	6
GSXVL 4060-R10-2.5D	●	6,0	1,0	15	—	60	6
GSXVL 4060-R15-2.5D	○	6,0	1,5	15	—	60	6
GSXVL 4080-R03-2.5D	●	8,0	0,3	20	—	80	8
GSXVL 4080-R05-2.5D	●	8,0	0,5	20	—	80	8
GSXVL 4080-R10-2.5D	●	8,0	1,0	20	—	80	8
GSXVL 4080-R15-2.5D	●	8,0	1,5	20	—	80	8
GSXVL 4080-R20-2.5D	○	8,0	2,0	20	—	80	8
GSXVL 4100-R03-2.5D	●	10,0	0,3	25	—	90	10
GSXVL 4100-R05-2.5D	●	10,0	0,5	25	—	90	10
GSXVL 4100-R10-2.5D	●	10,0	1,0	25	—	90	10
GSXVL 4100-R15-2.5D	○	10,0	1,5	25	—	90	10
GSXVL 4100-R20-2.5D	○	10,0	2,0	25	—	90	10
GSXVL 4120-R05-2.5D	●	12,0	0,5	30	—	90	12
GSXVL 4120-R10-2.5D	●	12,0	1,0	30	—	90	12
GSXVL 4120-R15-2.5D	●	12,0	1,5	30	—	90	12
GSXVL 4120-R20-2.5D	○	12,0	2,0	30	—	90	12
GSXVL 4120-R30-2.5D	○	12,0	3,0	30	—	90	12
GSXVL 4160-R10-2.5D	●	16,0	1,0	40	—	115	16
GSXVL 4160-R15-2.5D	●	16,0	1,5	40	—	115	16
GSXVL 4160-R20-2.5D	●	16,0	2,0	40	—	115	16
GSXVL 4160-R30-2.5D	○	16,0	3,0	40	—	115	16
GSXVL 4200-R10-2.5D	●	20,0	1,0	50	—	125	20
GSXVL 4200-R15-2.5D	○	20,0	1,5	50	—	125	20
GSXVL 4200-R20-2.5D	○	20,0	2,0	50	—	125	20
GSXVL 4200-R30-2.5D	●	20,0	3,0	50	—	125	20
GSXVL 4250-R10-2.5D	○	25,0	1,0	63	—	140	25
GSXVL 4250-R15-2.5D	○	25,0	1,5	63	—	140	25
GSXVL 4250-R20-2.5D	○	25,0	2,0	63	—	140	25
GSXVL 4250-R30-2.5D	○	25,0	3,0	63	—	140	25

Grade: ACF20

● Shoulder Milling and Grooving

Work Material	Carbon Steel, Cast Iron (150 to 250HB)		Alloy Steel (25 to 35HRC)		Tempered Steel, Hardened Steel (40 to 50HRC)		Stainless Steel		Heat Resistant Steel, Titanium Alloy (20 to 45HRC)		
	DC (mm)	Spindle Speed (rpm)	Feed Rate (mm/min)	Spindle Speed (rpm)	Feed Rate (mm/min)	Spindle Speed (rpm)	Feed Rate (mm/min)	Spindle Speed (rpm)	Feed Rate (mm/min)	Spindle Speed (rpm)	Feed Rate (mm/min)
2,0	9.000	720	6.000	430	4.000	320	5.500	320	2.600	120	
4,0	6.600	800	4.500	450	3.000	380	4.000	320	2.000	120	
6,0	4.800	960	3.000	480	2.500	380	3.000	480	1.200	120	
8,0	3.600	1.000	2.200	610	2.000	400	2.000	520	1.000	140	
10,0	2.800	1.000	1.800	610	1.500	400	1.700	550	800	160	
12,0	2.400	950	1.500	550	1.200	380	1.500	500	700	140	
14,0	2.200	880	1.300	490	1.000	360	1.200	430	600	130	
16,0	1.800	650	1.100	420	800	300	1.000	360	500	120	
18,0	1.600	580	1.000	360	750	270	900	340	450	110	
20,0	1.400	500	900	330	700	250	820	300	400	100	
Shoulder cutting	a <sub>p</sub>					1,5 DC					
	a <sub>e</sub>	0,1 DC			0,05 DC		0,1 DC		0,05 DC		
Grooving	a <sub>p</sub>	1,0 DC			0,2 DC		0,3 DC		0,2 DC		

Endmills

**SAFE-LOCK™**

Applicable Endmills



Endmills

Cat. No.	Stock	DC	RE	APMX	LU	LF	DMM
GSXVL 4120S-R05-2.5D	○	12,0	0,5	30	—	90	12
GSXVL 4120S-R10-2.5D	□	12,0	1,0	30	—	90	12
GSXVL 4120S-R15-2.5D	□	12,0	1,5	30	—	90	12
GSXVL 4120S-R20-2.5D	□	12,0	2,0	30	—	90	12
GSXVL 4120S-R30-2.5D	□	12,0	3,0	30	—	90	12
GSXVL 4160S-R10-2.5D	□	16,0	1,0	40	—	115	16
GSXVL 4160S-R15-2.5D	□	16,0	1,5	40	—	115	16
GSXVL 4160S-R20-2.5D	□	16,0	2,0	40	—	115	16
GSXVL 4160S-R30-2.5D	□	16,0	3,0	40	—	115	16
GSXVL 4200S-R10-2.5D	□	20,0	1,0	50	—	125	20
GSXVL 4200S-R15-2.5D	□	20,0	1,5	50	—	125	20
GSXVL 4200S-R20-2.5D	□	20,0	2,0	50	—	125	20
GSXVL 4200S-R30-2.5D	□	20,0	3,0	50	—	125	20
GSXVL 4250S-R10-2.5D	□	25,0	1,0	63	—	140	25
GSXVL 4250S-R15-2.5D	□	25,0	1,5	63	—	140	25
GSXVL 4250S-R20-2.5D	□	25,0	2,0	63	—	140	25
GSXVL 4250S-R30-2.5D	□	25,0	3,0	63	—	140	25

Grade: ACF20

■ Recommended Cutting Conditions

- For stable machining performance use rigid, high-precision machines and holders.
- Use air blowing when dry machining.
- Use wet machining for stainless steel, heat resistant alloy, and titanium alloy applications.
- If the machine cannot achieve the recommended spindle speed, please use the max. spindle speed available.

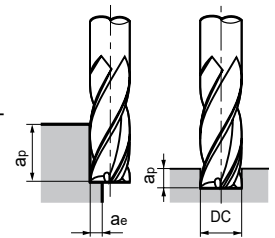

■ Corner Radius Selection

DC	RE0,2	RE0,3	RE0,5	RE1,0	RE1,5	RE2,0	RE3,0
3	□		□				
4	□		□				
5	□		□				
6		□	□	□			
8		□	□	□	□		
10		□	□	□	□	□	
12			□	□	□	□	□
16				□	□	□	□
20					□	□	□
25						□	□



### ■ Features

- Solid endmill EPMS-Series (**Ex Press Mill S**) for high-performance milling applications
- Higher efficiency and tool life due to new technology of latest developed carbide substrate and coating combined with the new optimized tool design
- Available with 4/5/6 flutes, different diameters and edge radii
- Excellent performance in machining of exotic alloys like Ti-alloys, super alloys and heat resistant steels
- Suitable for Titanium structure parts for airplane
- Anti-vibration design for reliable and efficient machining in a wide application range

### ■ Anti-Vibration Design

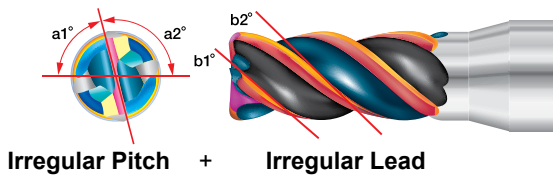

Reduce the vibration dramatically, especially for poor clamping and thin wall geometry, increase the parts accuracy and tool life for customers

### ■ Optimized Flute Geometry

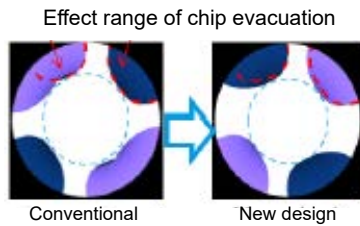

Smooth chip evacuation is realized to ensure stable and safe milling process for customers.

### ■ Comparison with other Milling Cutters

Description	Coating	Diameter	Peripheral Rake	Peripheral Relief	Helix Angle	Core Diameter	No. Edge	Radius Tolerance
GSXVL4000-R	GXS (TiAlCrN)	1–25	3–5	16	40/43	0,6D	4	-0,01/0,01
SSEHVL4000-R	GS Hard (TiAlCrSiCN)	4,5–25	5–7	17	42/45	0,65D	5	-0,01/0,01
EPMS4000-R	TiAlSiN	10–26	5–7	14	42/45	0,7D	6	-0,01/0,01

### ■ Suitable Applications

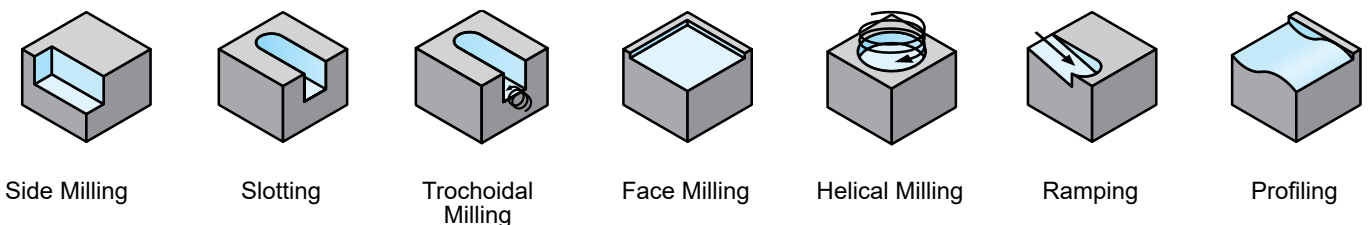



## Body

### EPMS 4000 Type

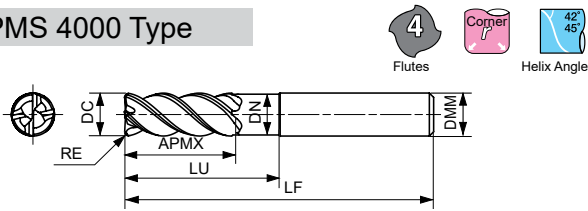

Cat. No.	Stock	DC	RE	APMX	LU	DN	LF	DMM
EPMS 4100U2.5R10	●	10	1,0	25	32	9,5	72	10
4100U2.5R30	●	10	3,0	25	32	9,5	72	10
EPMS 4120U2.5R10	●	12	1,0	30	38	11,5	83	12
4120U2.5R30	●	12	3,0	30	38	11,5	83	12
4120U2.5R40	●	12	4,0	30	38	11,5	83	12
EPMS 4160U2.5R30	●	16	3,0	40	50	15,5	100	16
4160U2.5R40	●	16	4,0	40	50	15,5	100	16

Grade: ECS300

### EPMS 5000 Type

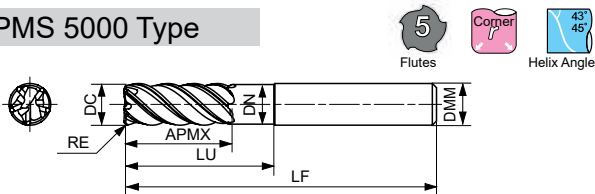

Cat. No.	Stock	DC	RE	APMX	LU	DN	LF	DMM
EPMS 5100U2.5R025	●	10	0,25	25	32	9,5	72	10
5100U2.5R15	●	10	1,5	25	32	9,5	72	10
5100U2.5R25	●	10	2,5	25	32	9,5	72	10
EPMS 5120U2.5R025	●	12	0,25	30	38	11,5	83	12
5120U2.5R05	●	12	0,5	30	38	11,5	83	12
5120U2.5R15	●	12	1,5	30	38	11,5	83	12
5120U2.5R20	●	12	2,0	30	38	11,5	83	12
5120U2.5R25	●	12	2,5	30	38	11,5	83	12
EPMS 5160U2.5R30	●	16	3,0	40	50	15,5	100	16
5160U2.5R40	●	16	4,0	40	50	15,5	100	16
EPMS 5200U2.5R30	●	20	3,0	50	62	19,5	125	20
5200U2.5R40	●	20	4,0	50	62	19,5	125	20

Grade: ECS300

### EPMS 6000 Type

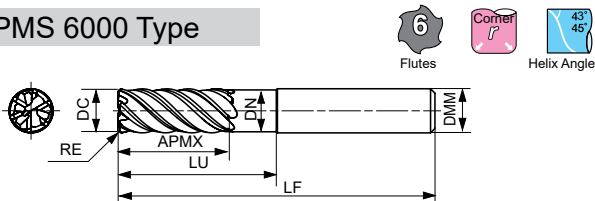

Cat. No.	Stock	DC	RE	APMX	LU	DN	LF	DMM
EPMS 6100U2.5R10	●	10	1,0	25	32	9,5	72	10
6100U2.5R30	●	10	3,0	25	32	9,5	72	10
EPMS 6120U2.5R10	●	12	1,0	30	38	11,5	83	12
6120U2.5R30	●	12	3,0	30	38	11,5	83	12
6120U2.5R40	●	12	4,0	30	38	11,5	83	12
EPMS 6160U2.5R15	●	16	1,5	40	50	15,5	100	16
6160U2.5R30	●	16	3,0	40	50	15,5	100	16
6160U2.5R40	●	16	4,0	40	50	15,5	100	16
EPMS 6200U2.5R30	●	20	3,0	50	62	19,5	125	20
6200U2.5R40	●	20	4,0	50	62	19,5	125	20

Grade: ECS300

## Identification Details

**EPMS 4 100 U2.5 R10 CS300**

Series Code	Number of Teeth	Diameter	Neck Type	Other Options*	Corner Radius	Grade
			U: Under Neck S: Straight+LxD	W: Weldon B: Chip Breaker	R10: = 1 mm C: Chamfer	

\* On request

## Cutting Conditions

### Side Milling

Work Material	Titanium Alloy, Stainless Steel				
	Cond.	Spindle Speed (min <sup>-1</sup> )	Feed Rate (mm/min)		
DC (mm)		EPMS4000	EPMS5000	EPMS6000	
10,0	3.200	1.280	1.920	3.840	
12,0	2.700	1.080	1.620	3.240	
16,0	2.000	800	1.200	2.400	
20,0	1.600	640	960	1.920	
a <sub>e</sub> (mm), <b>Standard</b> -Max.		0,2-0,4 DC	0,1-0,3 DC	0,06-0,1 DC	
a <sub>p</sub> (mm), <b>Standard</b> -Max.		2,0-2,5 DC			

Work Material	Heat-resistant Alloy				
	Cond.	Spindle Speed (min <sup>-1</sup> )	Feed Rate (mm/min)		
DC (mm)		EPMS4000	EPMS5000	EPMS6000	
10,0	1.600	380	640	960	
12,0	1.300	310	520	780	
16,0	1.000	240	400	600	
20,0	800	190	320	480	
a <sub>e</sub> (mm), <b>Standard</b> -Max.		0,2-0,4 DC	0,1-0,3 DC	0,06-0,1 DC	
a <sub>p</sub> (mm), <b>Standard</b> -Max.		2,0-2,5 DC			

### Slotting

Work Material	Titanium Alloy, Stainless Steel				
	Cond.	Spindle Speed (min <sup>-1</sup> )	Feed Rate (mm/min)		
DC (mm)		EPMS4000	EPMS5000	EPMS6000	
10,0	1.900	460	570	Not recommended	
12,0	1.600	380	480		
16,0	1.200	290	360		
20,0	960	230	290		
a <sub>p</sub> (mm), <b>Standard</b> -Max.		1,0-1,5 DC	0,5-1,0 DC		

Work Material	Heat-resistant Alloy				
	Cond.	Spindle Speed (min <sup>-1</sup> )	Feed Rate (mm/min)		
DC (mm)		EPMS4000	EPMS5000	EPMS6000	
10,0	960	230	290	Not recommended	
12,0	800	190	240		
16,0	600	140	180		
20,0	480	120	140		
a <sub>p</sub> (mm), <b>Standard</b> -Max.		0,3-0,5 DC	0,2-0,4 DC		

### Ramping / Helical Milling

Body Type	EPMS4000	EPMS5000	EPMS6000
RPMX, <b>Standard</b> -Max.	2,0°-3,0°		

#### Side Milling

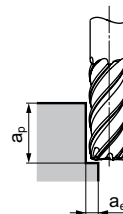

#### Slotting

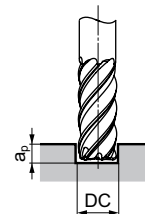

#### Ramping

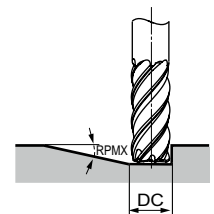



# SSEH Series



## SSEH Radius

### ■ Characteristics and Applications

- Steep helix (45° helix) improves sharpness.
- Combination of unique flute design and semi-mirrored surface improves chip evacuation and adhesion resistance.
- Ultra-smooth coating with improved hardness and heat resistance combined with tough carbide substrate improves tool life when working with heat resistant alloys.
- Unique, smooth radius shape mitigates cutting impact and improves fracture resistance.
- Both coated and uncoated types are available in stock to meet various conditions.

### ■ Application Examples

#### ● Inconel 718 (Side Milling)

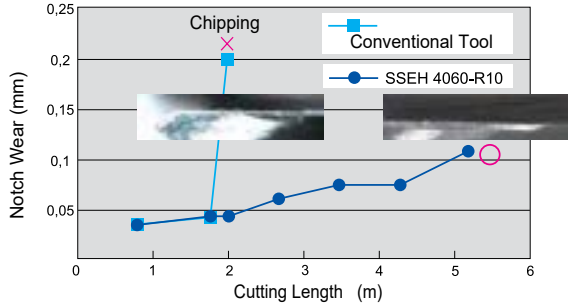

Tool Diameter:  $\varnothing 6 \times R1$   
 Cutting Conditions:  $v_c = 20 \text{ m/min}$ ,  $f_z = 0,025 \text{ mm/t}$ ,  
 $a_p = 5 \text{ mm}$ ,  $a_e = 0,5 \text{ mm}$ , wet

#### ● Inconel 713 (Side Milling)

SSEH 4100W-R10	Competitor's Product
Tool Diameter : $\varnothing 10 \times R1$ Cutting Conditions : $v_c = 32 \text{ m/min}$ , $f_z = 0,018 \text{ mm/t}$ $a_p = 20 \text{ mm}$ , $a_e = 0,8 \text{ m}$ , Dry	

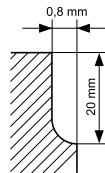

In Sumitomo Electric Hardmetal tests, the special coating with excellent adhesion resistance provided less cutting edge adhesion than the competitor's product and enabled fracturefree machining. The competitor's product suffered from edge adhesion leading to breakage.

Unique, smooth radius design

- = Euro stock
- = Japan stock

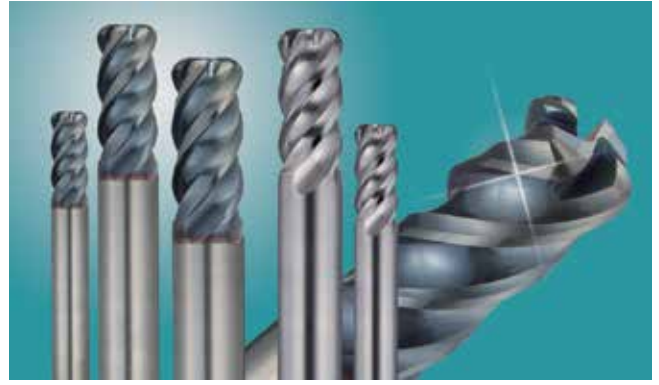

## SSEH Radius Anti-vibration Type

### ■ Characteristics and Applications

- New anti-vibration type added to the SSEH type endmill for exotic alloys.
- Builds on the same features of existing endmills by adding an irregular lead for exceptionally good anti-vibration performance.
- Compatible with wide range of milling for exotic alloys including SUS, Inconel, and titanium.
- Reduces chattering for high-speed, high-feed cutting.
- Both coated and uncoated types are available in stock to meet various conditions.

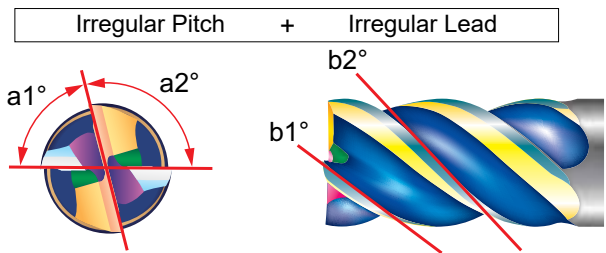

### ■ Application Examples

#### ● Surface Roughness Comparison

##### SSEH Anti-vibration Type



Good Surface Quality

Ra 0,37  $\mu\text{m}$  Rz 1,86  $\mu\text{m}$

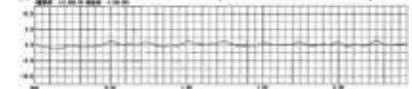

##### Conventional Tool



Surface shows chattering

Ra 1,52  $\mu\text{m}$  Rz 6,45  $\mu\text{m}$

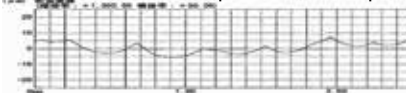

Work Material:

X5CrNi1810 (Surface Milling)

Tool Diameter:

$\varnothing 12 \text{ mm}$

Cutting Conditions:

$n = 1.300 \text{ rpm}$ ,  $v_f = 300 \text{ mm/min}$

$a_p = 18 \text{ mm}$ ,  $a_e = 1,2 \text{ mm}$

Equipment: BT50

□ = Delivery on request

and HAIMER's SAFE-LOCK™ Applicable Endmills

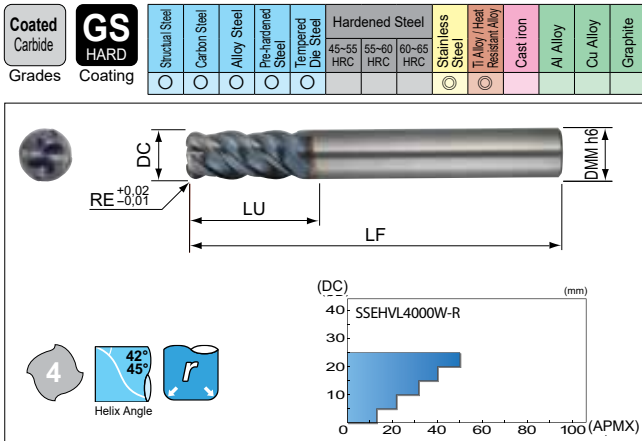

Grade: ACW52

■ Endmills

Cat. No.	Stock	DC	RE	LU	LF	DMM
SSEHVL 4045W-R05	●	4,5	0,5	12	50	6
SSEHVL 4045W-R10	○	4,5	1,0	12	50	6
SSEHVL 4050W-R05	●	5,0	0,5	13	60	6
SSEHVL 4050W-R10	○	5,0	1,0	13	60	6
SSEHVL 4060W-R10	○	6,0	1,0	13	60	6
SSEHVL 4080W-R10	●	8,0	1,0	19	80	8
SSEHVL 4100W-R10	●	10,0	1,0	22	90	10
SSEHVL 4100W-R30	●	10,0	3,0	22	90	10
SSEHVL 4120W-R10	●	12,0	1,0	26	90	12
SSEHVL 4120W-R30	●	12,0	3,0	26	90	12
SSEHVL 4160W-R10	●	16,0	1,0	32	115	16
SSEHVL 4160W-R30	●	16,0	3,0	32	115	16
SSEHVL 4200W-R10	○	20,0	1,0	40	125	20
SSEHVL 4200W-R30	○	20,0	3,0	40	125	20
SSEHVL 4250W-R10	○	25,0	1,0	50	140	25
SSEHVL 4250W-R30	○	25,0	3,0	50	140	25

SAFE-LOCK™

Applicable Endmills



■ Endmills

Cat. No.	Stock	DC	RE	LU	LF	DMM
SSEHVL 4120WS-R10	□	12,0	1,0	26	90	12
SSEHVL 4120WS-R30	□	12,0	3,0	26	90	12
SSEHVL 4160WS-R10	□	16,0	1,0	32	115	16
SSEHVL 4160WS-R30	□	16,0	3,0	32	115	16
SSEHVL 4200WS-R10	□	20,0	1,0	40	125	20
SSEHVL 4200WS-R30	□	20,0	3,0	40	125	20
SSEHVL 4250WS-R10	□	25,0	1,0	50	140	25
SSEHVL 4250WS-R30	□	25,0	3,0	50	140	25

■ Diameter and Corner Radius Selection Range

DC	RE0,5	RE1,0	RE3,0
4,5	●	○	
5		●	
6		○	
8		●	
10		●	●
12		●	●
16		●	●
20			□
25			□

■ Recommended Cutting Conditions

- For stable machining, a more rigid machine is recommended.
- Wet machining is recommended for stainless steel and heat resistant alloy applications.
- If cutting noise and vibration are present, please change the cutting conditions accordingly.

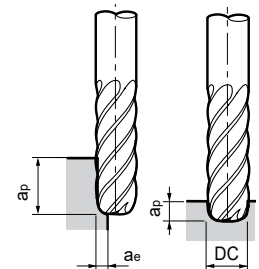

● Shoulder Milling

Work Material	Stainless Steel		Titanium Alloy		Heat Resistant Steel	
	Spindle Speed (rpm)	Feed Rate (mm/min)	Spindle Speed (rpm)	Feed Rate (mm/min)	Spindle Speed (rpm)	Feed Rate (mm/min)
DC (mm)						
4,5	3.500	350	3.500	280	2.100	170
5,0	3.200	380	3.200	320	1.900	190
6,0	2.700	430	2.700	320	1.600	190
8,0	2.000	400	2.000	280	1.200	170
10,0	1.600	380	1.600	260	1.000	160
12,0	1.300	360	1.300	230	800	140
16,0	1.000	320	1.000	200	600	120
20,0	800	260	800	160	480	100
25,0	640	200	640	130	380	80
Shoulder cutting	\$a_p\$	1,5 DC				
	\$a_e\$	0,1 DC	0,05 DC	0,05 DC		

● Grooving

Work Material	Stainless Steel		Titanium Alloy		Heat Resistant Steel	
	Spindle Speed (rpm)	Feed Rate (mm/min)	Spindle Speed (rpm)	Feed Rate (mm/min)	Spindle Speed (rpm)	Feed Rate (mm/min)
DC (mm)						
4,5	4.200	200	3.900	270	1.400	100
5,0	3.800	240	3.500	300	1.300	120
6,0	3.200	260	2.900	300	1.100	140
8,0	2.400	240	2.200	270	800	120
10,0	1.900	220	1.700	250	650	110
12,0	1.600	200	1.400	230	550	100
16,0	1.200	130	1.100	200	400	80
20,0	950	95	890	90	320	60
25,0	760	75	700	70	250	50
Grooving	\$a_p\$	0,3 DC	0,2 DC	0,15 DC		

# Radius Endmill for Exotic Alloys

## SSEH 4000W-R Type

4

4 Flutes Endmills with Radius Corner and

HAIMER's SAFE-LOCK™ Applicable Endmills

Coated Carbide	<b>GS</b> HARD	Structural Steel	Carbon Steel	Alloy Steel	Pre-hardened Steel	Tempered Die Steel	Hardened Steel	45-55 HRC	55-60 HRC	60-65 HRC	Stainless Steel	Ti Alloy / Heat Resistant Alloy	Cast Iron	Al Alloy	Cu Alloy	Graphite
Grades	Coating	○	○	○	○	○	○	○	○	○	○	○	○	○	○	○

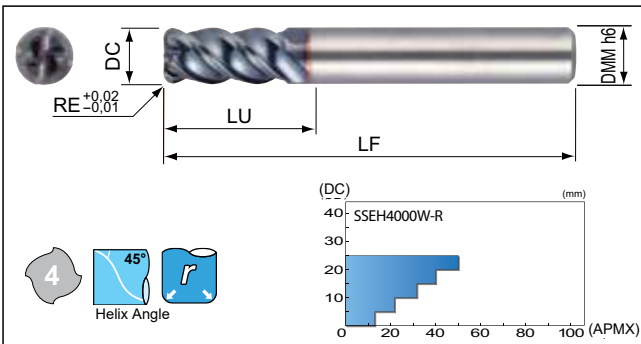

Grade: ACW52

### SAFE-LOCK™

Applicable Endmills



### Endmills

(mm)

Cat. No.	Stock	DC	APMX	LU	LF	DMM
SSEH 4045W-R05		4,5	0,5	12	50	6
SSEH 4050W-R05	○	5,0	0,5	13	60	6
SSEH 4060W-R10	●	6,0	1,0	13	60	6
SSEH 4080W-R10	●	8,0	1,0	19	80	8
SSEH 4100W-R10	●	10,0	1,0	22	90	10
SSEH 4100W-R30	○	10,0	3,0	22	90	10
SSEH 4120W-R10	●	12,0	1,0	26	90	12
SSEH 4120W-R30		12,0	3,0	26	90	12
SSEH 4160W-R10	●	16,0	1,0	32	115	16
SSEH 4160W-R30		16,0	3,0	32	115	16
SSEH 4200W-R10	○	20,0	1,0	40	125	20
SSEH 4200W-R30	○	20,0	3,0	40	125	20
SSEH 4250W-R10		25,0	1,0	50	140	25
SSEH 4250W-R30	○	25,0	3,0	50	140	25

### Endmills

(mm)

Cat. No.	Stock	DC	APMX	LU	LF	DMM
SSEH 4120WS-R10	□	12,0	1,0	26	90	12
SSEH 4120WS-R30	□	12,0	3,0	26	90	12
SSEH 4160WS-R10	□	16,0	1,0	32	115	16
SSEH 4160WS-R30	□	16,0	3,0	32	115	16
SSEH 4200WS-R10	□	20,0	1,0	40	125	20
SSEH 4200WS-R30	□	20,0	3,0	40	125	20
SSEH 4250WS-R10	□	25,0	1,0	50	140	25
SSEH 4250WS-R30	□	25,0	3,0	50	140	25

### Diameter and Corner Radius Selection Range

DC	RE0,5	RE1,0	RE3,0
4,5			
5	○		
6		●	
8		●	
10		●	○
12		●	
16		●	
20		○	○
25			○

### Recommended Cutting Conditions

- For stable machining, a more rigid machine is recommended.
- Wet machining is recommended for stainless steel and heat resistant alloy applications.
- If cutting noise and vibration are present, please change the cutting conditions accordingly.

### Shoulder Milling

Work Material	Stainless Steel		Titanium Alloy		Heat Resistant Steel	
	Spindle Speed (rpm)	Feed Rate (mm/min)	Spindle Speed (rpm)	Feed Rate (mm/min)	Spindle Speed (rpm)	Feed Rate (mm/min)
DC (mm) 4,5	3.500	350	3.500	280	2.100	170
5,0	3.200	380	3.200	320	1.900	190
6,0	2.700	430	2.700	320	1.600	190
8,0	2.000	400	2.000	280	1.200	170
10,0	1.600	380	1.600	260	1.000	160
12,0	1.300	360	1.300	230	800	140
16,0	1.000	320	1.000	200	600	120
20,0	800	260	800	160	480	100
25,0	640	200	640	130	380	80
Shoulder cutting	1,5 DC		1,5 DC		1,5 DC	
	$a_p$	0,1 DC	$a_p$	0,05 DC	$a_p$	0,05 DC
	$a_e$		$a_e$		$a_e$	

### Grooving

Work Material	Stainless Steel		Titanium Alloy		Heat Resistant Steel	
	Spindle Speed (rpm)	Feed Rate (mm/min)	Spindle Speed (rpm)	Feed Rate (mm/min)	Spindle Speed (rpm)	Feed Rate (mm/min)
DC (mm) 4,5	4,200	200	3,900	270	1,400	100
5,0	3,800	240	3,500	300	1,300	120
6,0	3,200	260	2,900	300	1,100	140
8,0	2,400	240	2,200	270	800	120
10,0	1,900	220	1,700	250	650	110
12,0	1,600	200	1,400	230	550	100
16,0	1,200	130	1,100	200	400	80
20,0	950	95	890	90	320	60
25,0	760	75	700	70	250	50
Grooving	0,3 DC		0,2 DC		0,15 DC	
	$a_p$		$a_p$		$a_p$	

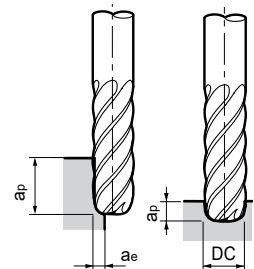

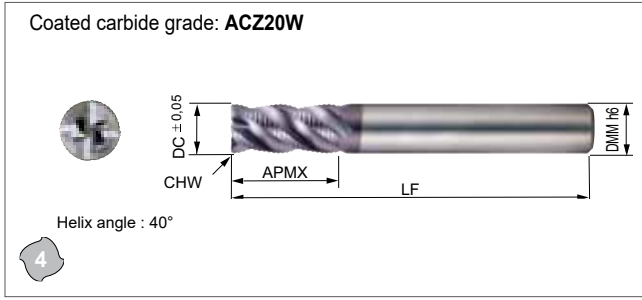

## Endmills (mm)

Cat. No.	Stock	DC	APMX	LF	CHW	DMM
GSRE 4060 SF	●	6,0	13	50	0,3	6
4070 SF	●	7,0	16	60	0,3	8
4080 SF	●	8,0	19	60	0,4	8
4090 SF	●	9,0	19	70	0,4	10
4100 SF	●	10,0	22	70	0,5	10
GSRE 4110 SF	●	11,0	22	75	0,5	12
4120 SF	●	12,0	26	75	0,6	12
4140 SF	●	14,0	26	90	0,6	16
4160 SF	●	16,0	32	90	0,8	16
4180 SF	●	18,0	32	100	0,8	20
GSRE 4200 SF	●	20,0	38	100	1,0	20

Recommended :

- (1) Cutting performance is improved when using a high rigidity machine.
- (2) Speeds and feeds should be reduced when there is any excessive vibration or strange noise during the operation.

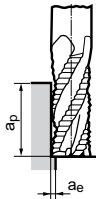

## Recommended Cutting Conditions

### Shoulder cutting

Material Cutting data Tool Dia. (mm)	Carbon steel ( HB150–250)		Cast iron		Alloy steel, Prehardened steel (HRC25–35)		Hardened steel (HRC40–50)		Stainless steel		Heat resistant alloys Titanium alloy		
	Speed (rpm)	Feed (mm/min)	Speed (rpm)	Feed (mm/min)	Speed (rpm)	Feed (mm/min)	Speed (rpm)	Feed (mm/min)	Speed (rpm)	Feed (mm/min)	Speed (rpm)	Feed (mm/min)	
1	4.800	1.200	5.800	1.500	3.200	380	2.600	400	4.300	250	1.600	90	
2	4.100	1.200	5.000	1.500	2.700	380	2.200	400	4.500	250	1.350	90	
3	3.600	1.200	4.500	1.500	2.400	380	2.000	400	4.000	250	1.250	90	
4	3.200	1.200	4.000	1.500	2.100	380	1.800	400	3.500	250	1.050	90	
5	2.800	1.200	2.500	1.500	1.900	380	1.600	400	3.200	250	1.000	100	
6	2.600	1.200	3.000	1.400	1.700	380	1.500	400	2.900	250	900	100	
8	2.400	1.200	2.900	1.400	1.600	400	1.300	400	2.600	250	800	100	
10	2.200	1.100	2.600	1.300	1.300	380	1.100	350	2.200	200	700	100	
12	1.800	900	2.200	1.100	1.200	380	1.000	350	2.000	180	600	100	
16	1.400	700	1.800	900	1.000	380	900	350	1.800	150	550	100	
20	1.400	700	1.700	800	850	380	800	350	1.600	150	500	100	
Shoulder cutting	$a_p$	1,5 DC				1,5 DC				1,5 DC			
	$a_e$	0,5 DC				0,3 DC				0,3 DC			

### Slotting

Material Cutting data Tool Dia. (mm)	Carbon steel ( HB150–250)		Cast iron		Alloy steel, Prehardened steel (HRC25–35)		Hardened steel (HRC40–50)		Stainless steel		Heat resistant alloys Titanium alloy		
	Speed (rpm)	Feed (mm/min)	Speed (rpm)	Feed (mm/min)	Speed (rpm)	Feed (mm/min)	Speed (rpm)	Feed (mm/min)	Speed (rpm)	Feed (mm/min)	Speed (rpm)	Feed (mm/min)	
1	3.600	900	4.300	1.100	2.400	300	1.700	260	4.200	250	1.100	60	
2	3.000	900	3.700	1.100	2.000	280	1.500	260	3.600	250	900	60	
3	2.700	900	3.400	1.100	1.800	280	1.350	260	3.200	250	800	60	
4	2.400	900	3.000	1.100	1.600	280	1.200	260	2.800	250	700	60	
5	2.100	900	2.600	1.100	1.400	280	1.100	270	2.500	250	650	65	
6	2.000	900	2.300	1.100	1.300	280	1.000	270	2.300	250	600	70	
8	1.800	900	2.200	1.100	1.200	300	900	270	2.100	250	550	70	
10	1.600	800	2.000	1.100	1.000	290	750	240	1.800	180	450	65	
12	1.350	650	1.650	850	900	280	700	240	1.600	160	400	65	
16	1.200	550	1.500	750	800	280	600	230	1.400	140	350	60	
20	1.050	500	1.350	700	700	280	550	210	1.250	125	300	60	
Slotting	$a_p$	1,0 DC				0,5 DC				0,5 DC			

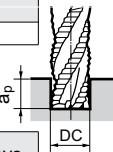

Coated Endmills

# GS MILL Series

## GSH 4000/6000/8000 SF Type

TiAlN Coated Fast Helix Endmills

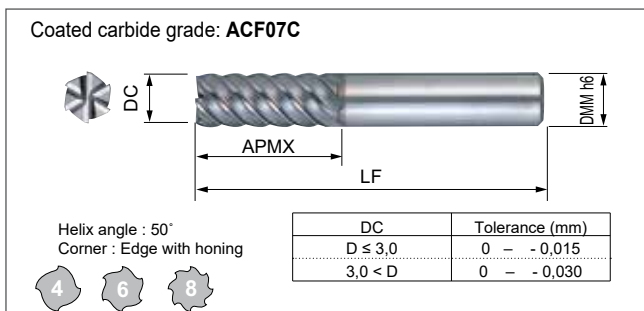

### Endmills (mm)

Cat. No.	Stock	DC	APMX	LF	DMM
GSH 4010 SF	●	1,0	3	50	6
4015 SF	●	1,5	4	50	6
4020 SF	●	2,0	6	50	6
GSH 6030 SF	●	3,0	8	50	6
6040 SF	●	4,0	11	50	6
6050 SF	●	5,0	12	50	6
6060 SF	●	6,0	13	50	6
6080 SF	●	8,0	19	60	8
6100 SF	●	10,0	22	70	10
6120 SF	●	12,0	26	75	12
GSH 8160 SF	●	16,0	32	90	16
8200 SF	●	20,0	38	100	20

Recommended :

- (1) Cutting performance is improved when using a high rigidity machine.
- (2) Speeds and feeds should be reduced when there is any excessive vibration or strange noise during the operation.

### Recommended Cutting Conditions

#### Conventional Milling Operations

Material Cutting data	Alloy steel, Prehardened steel (-HRC35)		Heat treated alloy steel, hardened steel (HRC35-45)		Hardened steel (HRC45-55)		Hardened steel (HRC55-60)		Hardened steel (HRC60-65)		Hardened steel (HRC65-)	
	Speed (rpm)	Feed (mm/min)	Speed (rpm)	Feed (mm/min)	Speed (rpm)	Feed (mm/min)	Speed (rpm)	Feed (mm/min)	Speed (rpm)	Feed (mm/min)	Speed (rpm)	Feed (mm/min)
1	20.000	540	20.000	390	15.600	260	12.300	160	11.100	140	7.800	95
2	19.000	1.100	17.200	770	13.400	530	10.500	320	9.500	270	6.700	190
3	15.000	2.150	13.400	1.540	10.400	1.050	8.200	650	7.400	540	5.200	380
4	11.200	2.400	10.000	1.740	7.800	1.180	6.100	730	5.600	600	3.900	420
5	9.000	2.700	8.000	1.930	6.200	1.300	4.900	810	4.400	670	3.100	470
6	7.500	2.700	6.700	1.930	5.200	1.300	4.100	810	3.700	670	2.600	470
8	5.600	2.700	5.000	1.930	3.900	1.300	3.050	810	2.800	670	1.950	470
10	4.500	2.700	4.000	1.930	3.100	1.300	2.450	810	2.200	670	1.550	470
12	3.750	2.700	3.350	1.930	2.600	1.300	2.050	810	1.850	670	1.300	470
16	2.800	2.500	2.500	1.800	1.950	1.220	1.530	760	1.400	630	980	440
20	2.250	2.100	2.000	1.540	1.550	1.050	1.230	650	1.100	540	780	380
Shoulder cutting	$a_p$	1-1,5 DC		1-1,5 DC		1-1,5 DC		1-1,5 DC		1-1,5 DC		
	$a_e$	0,1 DC		0,05 DC		0,05 DC		0,05 DC		0,02 DC		
Slotting	$a_p$	0,1 DC		0,05 DC		0,05 DC		0,05 DC		-0,05 DC (Max 0,5)		

#### HSC Machining Centre Operations

Material Cutting data	Alloy steel, Prehardened steel (-HRC35)		Heat treated alloy steel, hardened steel (HRC35-45)		Hardened steel (HRC45-55)		Hardened steel (HRC55-60)		Hardened steel (HRC60-65)			
	Speed (rpm)	Feed (mm/min)	Speed (rpm)	Feed (mm/min)	Speed (rpm)	Feed (mm/min)	Speed (rpm)	Feed (mm/min)	Speed (rpm)	Feed (mm/min)		
1	48.000	1.250	48.000	1.250	48.000	1.250	48.000	930	38.000	700		
2	48.000	2.850	48.000	2.850	48.000	2.850	36.000	1.600	24.000	1.000		
3	32.000	4.900	32.000	4.900	32.000	4.900	24.000	2.740	16.000	1.700		
4	24.000	5.200	24.000	5.200	24.000	5.200	18.000	2.900	12.000	1.800		
5	19.200	5.800	19.200	5.800	19.200	5.800	14.300	3.200	9.600	2.000		
6	16.000	5.800	16.000	5.800	16.000	5.800	12.000	3.200	8.000	2.000		
8	12.000	5.800	12.000	5.800	12.000	5.800	9.000	3.200	6.000	2.000		
10	9.600	5.800	9.600	5.800	9.600	5.800	7.200	3.200	4.800	2.000		
12	8.000	5.800	8.000	5.800	8.000	5.800	6.000	3.200	4.000	2.000		
16	6.000	5.400	6.000	5.400	6.000	5.400	4.500	3.000	3.000	1.900		
20	4.800	4.600	4.800	4.600	4.800	4.600	3.600	2.580	2.400	1.600		
Shoulder cutting	$a_p$	1-1,5 DC		1-1,5 DC		1-1,5 DC		1-1,5 DC		1-1,5 DC		
	$a_e$	0,1 DC		0,05 DC		0,02 DC		0,12 DC		0,12 DC		

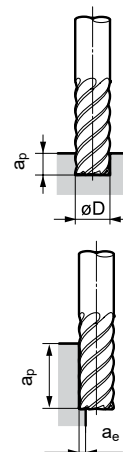

● = Euro stock



# DLC (Diamond Like Carbon) Coating AURORA COAT Series



## ■ Features



Sumitomo Electric's "AURORA" COAT is a high hardness, low coefficient layer of "Diamond Like Carbon" (DLC).

Other than producing excellent surface finish for machining of Aluminium and non-ferrous metals, DLC coat can be used for dry cutting and is environmental friendly.

## ■ Characteristics / Application

- Very smooth AURORA COAT results in low adhesion as well as good surface finish
- With lower cutting forces and high rigidity, this series is suitable for low rigidity machine
- Available in 2 and 4 flutes square type as well as ballnose type endmills

## ■ Product Range

Series	No. of teeth	Shape	Diameter
ASM2000DL	2	Square 	ø 2 – ø 16
ASM4000DL	4	Square 	ø 2 – ø 16
SNB2000DL	2	Ballnose 	ø 2 – ø 16 (R1 – R8)

## ■ Efficiency

### ● Performance Comparison

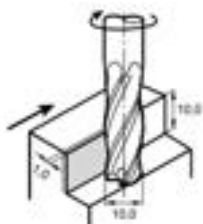
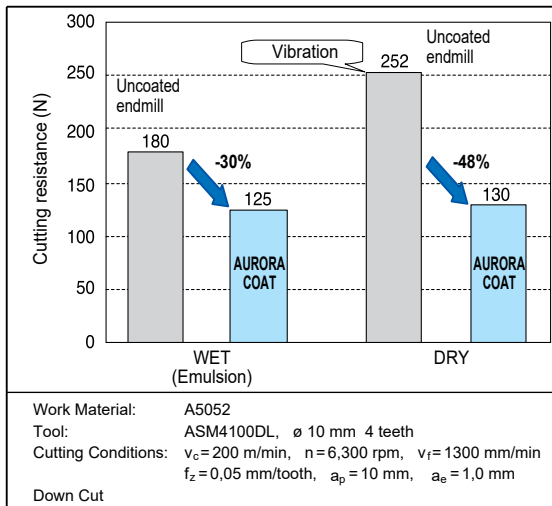

### ● Surface Finish Comparison

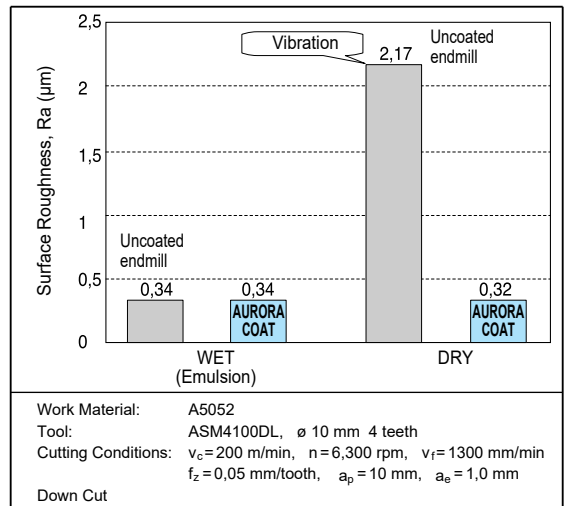



# AURORA Coated Spiral Endmills ASM 2000/4000 DL Type

# AURORA Coated Spiral Endmills ASM 2000/4000 DL-R Type

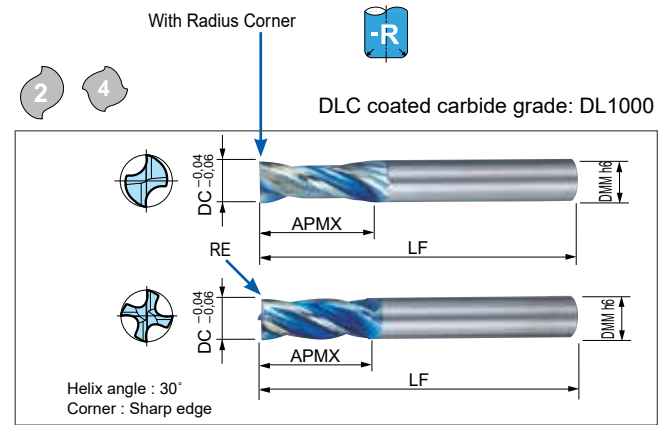
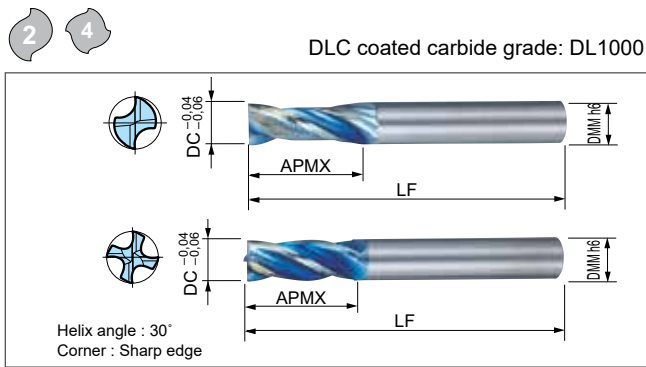

## Endmills (mm)

Cat. No.	Stock	DC	APMX	LF	DMM
ASM 2020 DL	●	2,0	6	40	4
2030 DL	●	3,0	10	45	6
2040 DL	●	4,0	12	45	6
2050 DL	●	5,0	15	50	6
ASM 2060 DL	●	6,0	15	50	6
2080 DL	●	8,0	18	60	8
2100 DL	●	10,0	22	71	10
ASM 2120 DL	●	12,0	25	75	12
2160 DL	●	16,0	32	90	16

ASM 4020 DL	●	2,0	6	40	4
4030 DL	●	3,0	10	45	6
4040 DL	●	4,0	12	45	6
4050 DL	●	5,0	15	50	6
ASM 4060 DL	●	6,0	15	50	6
4080 DL	●	8,0	18	60	8
4100 DL	●	10,0	22	71	10
ASM 4120 DL	●	12,0	25	75	12
4160 DL	●	16,0	32	90	16

## Endmills (mm)

Cat. No.	Stock	DC	RE	APMX	LF	DMM
ASM 2080 DL-R10	●	8,0	1,0	18	60	8
2080 DL-R20	□	8,0	2,0	18	60	8
ASM 2100 DL-R10	□	10,0	1,0	22	71	10
2100 DL-R20	□	10,0	2,0	22	71	10
ASM 2120 DL-R20	□	12,0	2,0	25	75	12
2120 DL-R30	□	12,0	3,0	25	75	12
ASM 2160 DL-R30	□	16,0	3,0	32	90	16

ASM 4080 DL-R10	□	8,0	1,0	18	60	8
4080 DL-R20	□	8,0	2,0	18	60	8
ASM 4100 DL-R10	●	10,0	1,0	22	71	10
4100 DL-R20	□	10,0	2,0	22	71	10
ASM 4120 DL-R20	□	12,0	2,0	25	75	12
4120 DL-R30	□	12,0	3,0	25	75	12
ASM 4160 DL-R30	●	16,0	3,0	32	90	16

## Recommended Cutting Conditions

Recommended :

- (1) Cutting performance is improved when using a high rigidity machine.
- (2) Speeds and feeds should be reduced when there is any excessive vibration or strange noise during the operation.
- (3) In case of chatter first check the cutting conditions.

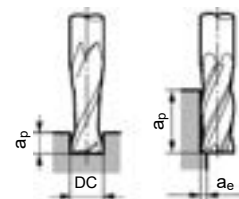

Work Material		Aluminium Alloy							
Cutting data DC (mm)		Wet (Emulsion)				Dry			
		Side Milling (4 teeth)		Groove Milling (4 teeth)		Side Milling (4 teeth)		Groove Milling (4 teeth)	
		Speed (rpm)	Feed (mm/min)	Speed (rpm)	Feed (mm/min)	Speed (rpm)	Feed (mm/min)	Speed (rpm)	Feed (mm/min)
2,0		40.000	1.400	28.000	280	40.000	980	28.000	200
3,0		32.000	2.000	22.000	400	32.000	1.400	22.000	280
4,0		26.000	2.600	18.000	520	26.000	1.800	18.000	360
5,0		20.000	2.600	14.000	520	20.000	1.800	14.000	360
6,0		17.000	2.700	12.000	540	17.000	1.900	12.000	370
8,0		13.000	2.700	9.000	540	13.000	1.900	9.000	370
10,0		11.000	2.800	7.200	560	11.000	2.000	7.200	390
12,0		8.500	2.800	6.000	560	8.500	2.000	6.000	390
16,0		6.400	2.800	4.500	560	6.400	2.000	4.500	390
Depth and wide of cut	a <sub>p</sub>	1,5 DC		1,0 DC		1,5 DC		0,5 DC	
	a <sub>e</sub>	0,2 DC		(DC)		0,2 DC		(DC)	

● = Euro stock  
○ = Japan stock

□ = Delivery on request

# ZX Coated Long Fast Helix Endmills

## LHHM 4000/6000/8000 ZX Type

# ZX Coated Extra Long Fast Helix Endmills

## EHHM 4000/6000/8000 ZX Type



Coated carbide grade: ACZ10M

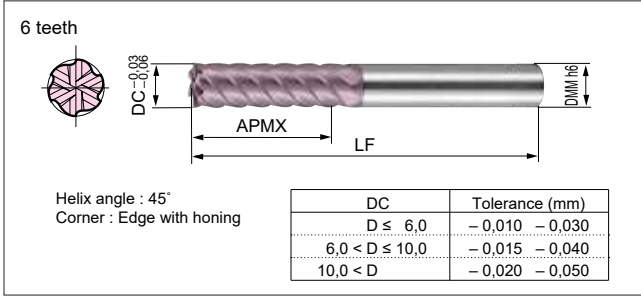

Coated carbide grade: ACZ10M

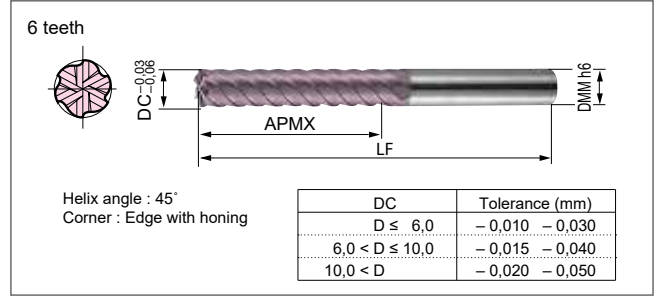

### Endmills (mm)

Cat. No.	Stock	DC	APMX	LF	DMM
LHHM 4030 ZX	○	3,0	12	55	6
4040 ZX	○	4,0	15	60	6
4050 ZX	○	5,0	18	60	6

LHHM 6060 ZX	○	6,0	18	60	6
6080 ZX	○	8,0	25	75	8
6100 ZX	○	10,0	30	80	10
6120 ZX	○	12,0	30	100	12

LHHM 8160 ZX	○	16,0	50	105	16
8200 ZX	○	20,0	55	120	20
8250 ZX	○	25,0	65	140	25
8300 ZX	□	30,0	75	160	32

### Endmills (mm)

Cat. No.	Stock	DC	APMX	LF	DMM
EHHM 4030 ZX	○	3,0	20	60	6
4040 ZX	○	4,0	25	65	6
4050 ZX	○	5,0	30	70	6

EHHM 6060 ZX	○	6,0	30	70	6
6080 ZX	○	8,0	40	90	8
6100 ZX	○	10,0	50	100	10
6120 ZX	○	12,0	50	120	12

EHHM 8160 ZX	○	16,0	70	140	16
8200 ZX	○	20,0	85	165	20
8250 ZX	○	25,0	100	185	25
8300 ZX	○	30,0	110	205	32
8320 ZX	○	32,0	110	205	32

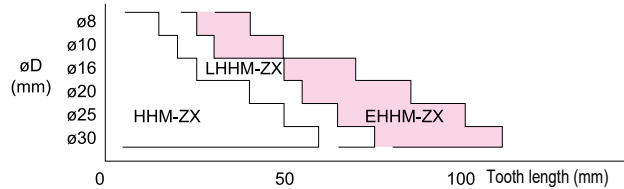
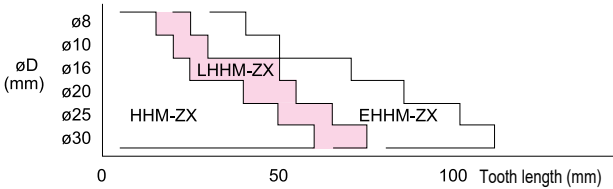

Recommended conditions (Shoulder processing)  $a_p = 1,5 \times \phi D$   
 $a_e = 0,025(\text{HRC}56-65) \sim 0,2(\text{below HRC}25) \times \phi D$

DC	Material	Carbon steel, Alloy steel		Hardened steel	Cast iron
		(BelowHRC25)	(BelowHRC45)	(BelowHRC65)	
3,0-5,0	$v_c$	200-250-300	100-150-200	80-100-120	60-75-90
	$f_z$	0,030-0,060	0,022-0,037	0,007-0,015	0,030-0,060
6,0-12,0	$v_c$	200-250-300	100-150-200	80-100-120	40-50-60
	$f_z$	0,061-0,090	0,037-0,067	0,015-0,028	0,060-0,165
16,0-32,0	$v_c$	200-250-300	100-150-200	80-100-120	40-50-60
	$f_z$	0,090-0,098	0,067-0,075	0,028-0,038	0,187-0,262

$v_c = \text{m/min}$   $f_z = \text{mm/tooth}$

Recommended conditions (Shoulder processing)  $a_p = 1,5 \times \phi D$   
 $a_e = 0,025(\text{HRC}56-65) \sim 0,2(\text{below HRC}25) \times \phi D$

DC	Material	Carbon steel, Alloy steel		Hardened steel	Cast iron
		(BelowHRC25)	(BelowHRC45)	(BelowHRC65)	
3,0-5,0	$v_c$	200-250-300	100-150-200	80-100-120	100-120-150
	$f_z$	0,020-0,040	0,015-0,025	0,005-0,010	0,020-0,040
6,0-12,0	$v_c$	200-250-300	100-150-200	80-100-120	100-120-150
	$f_z$	0,041-0,060	0,025-0,045	0,010-0,019	0,040-0,110
16,0-32,0	$v_c$	200-250-300	100-150-200	80-100-120	100-120-150
	$f_z$	0,060-0,065	0,045-0,050	0,019-0,025	0,125-0,175

$v_c = \text{m/min}$   $f_z = \text{mm/tooth}$

# High Efficient Endmills SSUP MILL Series



## ■ Features

ZX coated general use endmill for high efficient slotting and side cutting of steels, stainless steels, high temperature alloys and cast irons.

Unique flute design and strong cutting edge ensure excellent chip control even when rough machining slots.

Feed rate up to 2000 mm/min with and without coolant

## ■ Advantages

- Unique flute design for excellent chip removal
- Extra strong cutting edge
- 40° high helix angle for high feed rates
- New ZX coating for excellent wear resistance
- Smooth cutting
- Excellent rigid wide cutting land



SSUP 4000ZX-R Series  
Diameter and Corner Radius Range

DC	RE	RE0,2	RE0,3	RE0,5	RE1,0	RE1,5	RE2,0	RE3,0
3	●			●				
4	●				●			
5	●			●	●			
6			●	●	●	●		
8			●	●	●	●		
10			●	●	●	●	●	
12				●	●	●	●	●
16					●	●	●	●
20						●	●	●

## ■ Performance

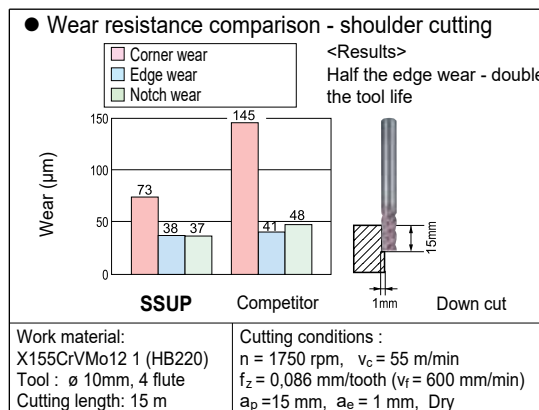
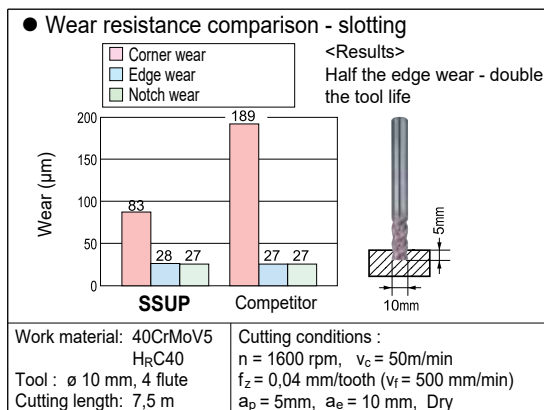
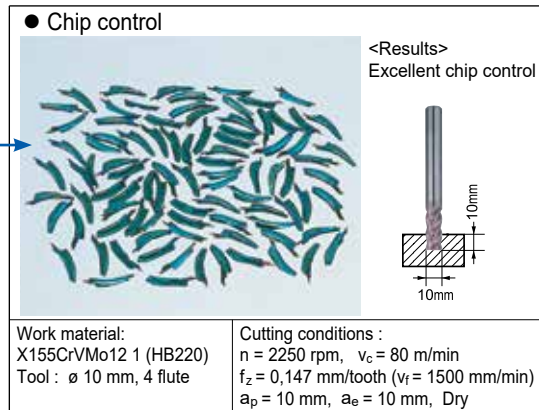
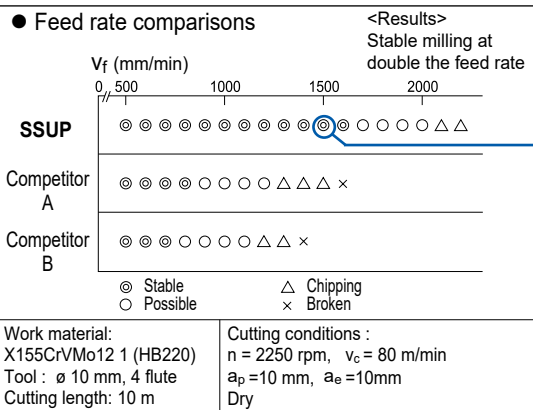

# ZX Coated SSUP MILL SSUP 4000ZX Type

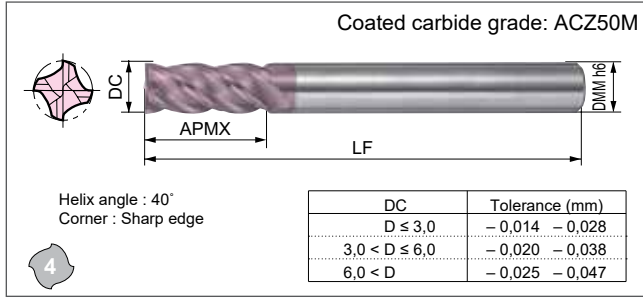

# ZX Coated SSUP MILL SSUP 4000ZX-R Type

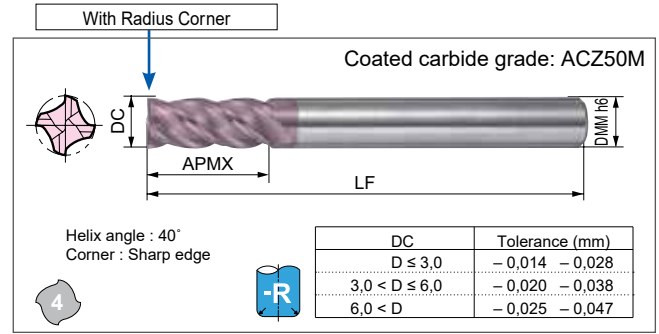

## Endmills (mm)

Cat. No.	Stock	DC	APMX	LF	DMM
SSUP 4020 ZX	●	2,0	6	50	4
4030 ZX	●	3,0	8	50	6
4040 ZX	●	4,0	11	50	6
4050 ZX	●	5,0	13	60	6
SSUP 4060 ZX	●	6,0	13	60	6
4070 ZX	●	7,0	16	70	8
4080 ZX	●	8,0	19	80	8
4090 ZX	●	9,0	19	90	10
4100 ZX	●	10,0	22	90	10
SSUP 4110 ZX	●	11,0	22	90	12
4120 ZX	●	12,0	26	90	12
4140 ZX	●	14,0	26	110	16
4150 ZX	○	15,0	26	110	16
SSUP 4160 ZX	●	16,0	32	115	16
4180 ZX	○	18,0	32	120	20
4200 ZX	●	20,0	38	125	20

## Endmills (mm)

Cat. No.	Stock	DC	RE	APMX	LF	DMM
SSUP 4030 ZX-R02	●	3,0	0,2	8	50	6
4030 ZX-R05	○	3,0	0,5	8	50	6
SSUP 4040 ZX-R02	●	4,0	0,2	11	50	6
4040 ZX-R05	●	4,0	0,5	11	50	6
4040 ZX-R10	○	4,0	1,0	11	50	6
SSUP 4050 ZX-R02	●	5,0	0,2	13	60	6
4050 ZX-R05	●	5,0	0,5	13	60	6
4050 ZX-R10	○	5,0	1,0	13	60	6
SSUP 4060 ZX-R03	●	6,0	0,3	13	60	6
4060 ZX-R05	●	6,0	0,5	13	60	6
4060 ZX-R10	●	6,0	1,0	13	60	6
4060 ZX-R15	○	6,0	1,5	13	60	6
SSUP 4080 ZX-R03	●	8,0	0,3	13	80	8
4080 ZX-R05	●	8,0	0,5	13	80	8
4080 ZX-R10	●	8,0	1,0	19	80	8
4080 ZX-R15	○	8,0	1,5	19	80	8
4080 ZX-R20	○	8,0	2,0	19	80	8
SSUP 4100 ZX-R03	●	10,0	0,3	22	90	10
4100 ZX-R05	●	10,0	0,5	22	90	10
4100 ZX-R10	●	10,0	1,0	22	90	10
4100 ZX-R15	○	10,0	1,5	22	90	10
4100 ZX-R20	○	10,0	2,0	22	90	10
SSUP 4120 ZX-R05	●	12,0	0,5	26	90	12
4120 ZX-R10	●	12,0	1,0	26	90	12
4120 ZX-R15	●	12,0	1,5	26	90	12
4120 ZX-R20	○	12,0	2,0	26	90	12
4120 ZX-R30	○	12,0	3,0	26	90	12
SSUP 4160 ZX-R10	●	16,0	1,0	32	115	16
4160 ZX-R15	●	16,0	1,5	32	115	16
4160 ZX-R20	○	16,0	2,0	32	115	16
4160 ZX-R30	○	16,0	3,0	32	115	16
SSUP 4200 ZX-R10	●	20,0	1,0	38	125	20
4200 ZX-R15	○	20,0	1,5	38	125	20
4200 ZX-R20	○	20,0	2,0	38	125	20
4200 ZX-R30	○	20,0	3,0	38	125	20

## Recommended Cutting Conditions

Material	Carbon steel, Cast iron (Hb150-250)		Alloy steel, Prehardened steel (HRC25-35)		Hardened steel (HRC40-50)		Stainless steel		Heat resistant alloys Titanium alloy (HRC20-45)	
	Speed (rpm)	Feed (mm/min)	Speed (rpm)	Feed (mm/min)	Speed (rpm)	Feed (mm/min)	Speed (rpm)	Feed (mm/min)	Speed (rpm)	Feed (mm/min)
2	9000	720	6000	430	4000	320	5500	320	2600	120
4	6600	800	4500	450	3000	380	4000	320	2000	120
6	4800	960	3000	480	2500	380	3000	480	1200	120
8	3600	1000	2200	610	2000	400	2000	520	1000	140
10	2800	1000	1800	610	1500	400	1700	550	800	160
12	2400	950	1500	550	1200	380	1500	500	700	140
14	2200	880	1300	490	1000	360	1200	430	600	130
16	1800	650	1100	420	800	300	1000	360	500	120
18	1600	580	1000	360	750	270	900	340	450	110
20	1400	500	900	330	700	250	820	300	400	100
Shoulder cutting	$a_p$	1,5 DC								
	$a_e$	0,1 DC		0,05 DC		0,1 DC		0,05 DC		
Slotting	$a_p$	1,0 DC								

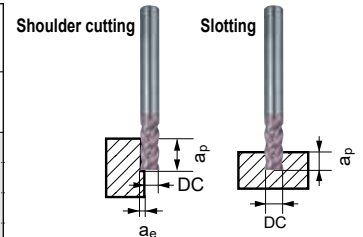

- (1) Cutting performance is improved when using a high rigidity machine.
- (2) Speeds and feeds should be reduced when slotting some stainless steels.
- (3) In case of chatter first check the cutting conditions.

# GSX MILL Ball Endmills GSXB 20000 Type



Structural Steel	Carbon Steel	Alloy Steel	Pre-hardened Steel	Tempered Die Steel	Hardened Steel	45-55 HRC	55-60 HRC	60-65 HRC	Stainless Steel	Ti Alloy / Heat Resistant Alloy	Cast Iron	Al Alloy	Cu Alloy	Graphite
○	○	○	○	○	○	○	○	○	○	○	○	○	○	○

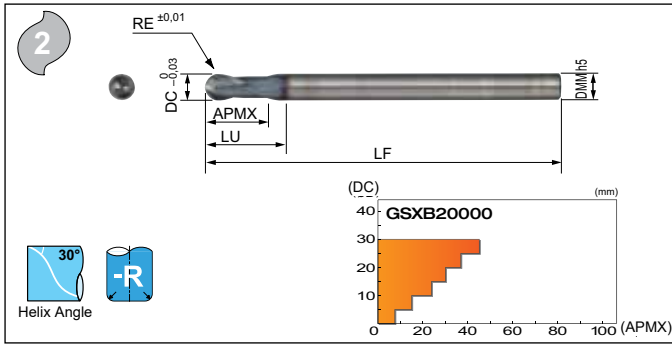

Coated carbide grade: **ACB20**

## Endmill Identification (GSXB Type)

### GSXB 2 0200

Series Code: GSXB 2 0200  
No. of Teeth: 2  
Radius of Ballnose: 2.00

## Endmills

Cat. No.	Stock	RE	DC	APMX	LU	LF	DMM
GSXB 20020	●	0,20	0,4	0,6	0,8	50	4
GSXB 20030	●	0,30	0,6	0,9	1,2	50	4
GSXB 20050	●	0,50	1,0	1,5	2,0	50	4
GSXB 20075	●	0,75	1,5	2,5	3,0	50	4
GSXB 20100	●	1,00	2,0	3,0	4,0	60	6
GSXB 20125	●	1,25	2,5	4,0	5,0	60	6
GSXB 20150	●	1,50	3,0	4,5	6,0	60	6
GSXB 20200	●	2,00	4,0	6,0	8,0	70	6
GSXB 20250	●	2,50	5,0	7,5	10,0	80	6
GSXB 20300	●	3,00	6,0	9,0	-	80	6
GSXB 20350	●	3,50	7,0	11,0	20,0	90	8
GSXB 20400	●	4,00	8,0	12,0	-	90	8
GSXB 20500	●	5,00	10,0	15,0	-	100	10
GSXB 20600	●	6,00	12,0	18,0	-	110	12
GSXB 20700	●	7,00	14,0	21,0	38,0	110	16
GSXB 20800	●	8,00	16,0	24,0	-	140	16
GSXB 20900	●	9,00	18,0	27,0	50,0	140	20
GSXB 21000	○	10,00	20,0	30,0	-	160	20
GSXB 21250	○	12,50	25,0	38,0	-	180	25
GSXB 21500	○	15,00	30,0	45,0	80,0	180	32



New "Global Standard" Mills  
Ball nose type with 2 teeth

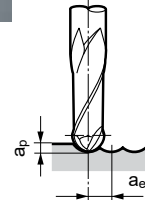

## Recommended Cutting Conditions

- (1) If cutting noise and vibration are present, please change the cutting conditions accordingly.
- (2) If the machine is not designed to achieve the recommended spindle speed, please use the max. spindle speed available.

## Radius Milling

Work Material	Carbon Steel, Alloy Steel (Below 25HRC)		Carbon Steel, Alloy Steel (Below 50HRC)		Cast Iron Special Cast Iron		Stainless Steel Titanium Alloy	
	Spindle Speed (rpm)	Feed Rate (mm/min)	Spindle Speed (rpm)	Feed Rate (mm/min)	Spindle Speed (rpm)	Feed Rate (mm/min)	Spindle Speed (rpm)	Feed Rate (mm/min)
RE (mm) 0,20	50.000	2.100	35.000	1.150	50.000	2.100	50.000	1.750
0,30	50.000	2.500	35.000	1.350	50.000	2.500	50.000	2.100
0,50	50.000	3.000	35.000	1.600	50.000	3.000	50.000	2.500
0,75	35.000	3.000	24.000	1.650	35.000	3.200	34.000	2.500
1,00	27.500	3.000	19.000	1.700	35.000	3.900	26.000	2.500
1,25	22.500	3.000	15.500	1.700	28.000	3.900	21.000	2.500
1,50	19.000	3.000	13.000	1.700	24.000	3.900	17.500	2.500
2,00	17.000	3.800	12.000	2.100	20.000	4.100	15.000	2.700
2,50	15.500	4.300	11.000	2.200	18.000	4.600	12.000	2.500
3,00	14.000	4.700	10.500	2.500	16.500	5.300	10.500	2.500
3,50	12.500	4.200	9.000	2.100	14.000	4.500	9.000	2.200
4,00	11.000	3.500	7.900	1.900	12.500	4.000	7.800	1.900
5,00	9.000	2.800	6.300	1.500	10.500	3.300	6.300	1.500
6,00	7.500	2.400	5.200	1.250	8.700	2.800	5.200	1.250
7,00	6.400	2.100	4.500	1.100	7.400	2.400	4.500	1.100
8,00	5.600	1.800	3.900	950	6.500	2.100	3.900	950
9,00	5.000	1.600	3.500	850	5.800	1.900	3.500	850
10,00	4.500	1.450	3.100	750	5.200	1.700	3.150	750
12,50	3.600	1.150	2.500	600	4.200	1.350	2.500	600
15,00	3.000	960	2.100	500	3.500	1.150	2.100	500
Depth and wide of cut	ap	0,02 DC	0,02 DC	0,02 DC	0,02 DC	0,02 DC	0,02 DC	0,02 DC
	ae	0,05 DC	0,05 DC	0,05 DC	0,05 DC	0,05 DC	0,05 DC	0,05 DC

● = Euro stock  
○ = Japan stock

## DLC (Diamond Like Carbon) Coating

2

DLC coated carbide grade: DL1200

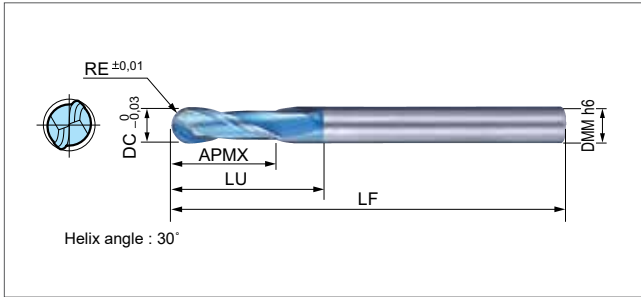

### Endmills (mm)

Cat. No.	Stock	RE	DC	APMX	LU	LF	DMM
SNB 2020 DL	●	1,0	2,0	3	5	60	6
2030 DL	●	1,5	3,0	4,5	8	80	6
SNB 2040 DL	●	2,0	4,0	6	12	80	6
2050 DL	●	2,5	5,0	7,5	14	90	6
SNB 2060 DL	●	3,0	6,0	9	-	100	6
2080 DL	●	4,0	8,0	12	-	100	8
2100 DL	●	5,0	10,0	15	-	120	10
SNB 2120 DL	●	6,0	12,0	18	-	120	12
2160 DL	●	8,0	16,0	24	-	160	16

### Characteristics / Application

- Very smooth AURORA COAT results in low adhesion as well as good surface finish
- With lower cutting forces and high rigidity, this series is suitable for low rigidity machine

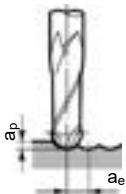

### Recommended Cutting Conditions

Work Material	Aluminum Alloy				
	Cutting data	Wet (Emulsion)		Dry	
		Speed (rpm)	Feed (mm/min)	Speed (rpm)	Feed (mm/min)
RE (mm)					
1,0	48.000	1.500	48.000	1.000	
1,5	48.000	2.100	48.000	1.500	
2,0	31.000	2.800	31.000	2.000	
2,5	24.000	2.800	24.000	2.000	
3,0	20.000	2.800	20.000	2.000	
4,0	15.000	2.800	15.000	2.000	
5,0	13.000	3.000	13.000	2.100	
6,0	10.000	3.000	10.000	2.100	
8,0	7.700	3.000	7.700	2.100	
Depth and wide of cut	$a_p$	1,5 DC	1,0 DC		
	$a_e$	0,2 DC	(DC)		



# Spiral Endmills for Non-Ferrous Cutting

## ASM 2000 Type

2

Carbide grade: H1 (Micrograin)

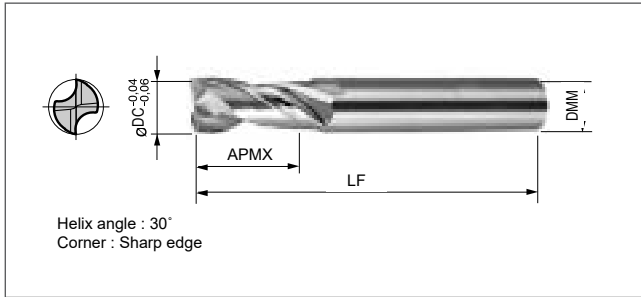

### Endmills (mm)

Cat. No.	Stock	DC	APMX	LF	DMM
ASM 2020	○	2,0	6	40	4
2030	○	3,0	10	45	6
2040	○	4,0	12	45	6
2050	○	5,0	15	50	6
ASM 2060	○	6,0	15	50	6
2080	○	8,0	18	60	8
2100	○	10,0	22	71	10
ASM 2120	○	12,0	25	75	12
2140	○	14,0	32	90	16
2150	○	15,0	32	90	16
2160	○	16,0	32	90	16

Uncoated  
Endmills

### Recommended Conditions

(Shoulder processing)  $a_p = 1,5 \times DC$   
 $a_e = 0,1 \times DC$

DC	Material	
	Al-alloy	Cast iron
1 – 2,5	$v_c$	100-200-300
	$f_z$	0,004–0,017
3 – 5	$v_c$	100-200-300
	$f_z$	0,018–0,036
6 – 12	$v_c$	100-200-300
	$f_z$	0,038–0,070
14 – 16	$v_c$	100-200-300
	$f_z$	0,075–0,125

$v_c = \text{m/min}$   $f_z = \text{mm/tooth}$

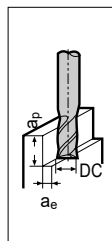

# SSEHVL 4000-R Type

Uncoated Carbide	4	Structural Steel	Carbon Steel	Alloy Steel	Pre-hardened Steel	Tempered Die Steel	Hardened Steel			Stainless Steel	Ti Alloy / Heat Resistant Alloy	Cast Iron	Al Alloy	Cu Alloy	Graphite
							45-55 HRC	55-60 HRC	60-65 HRC						

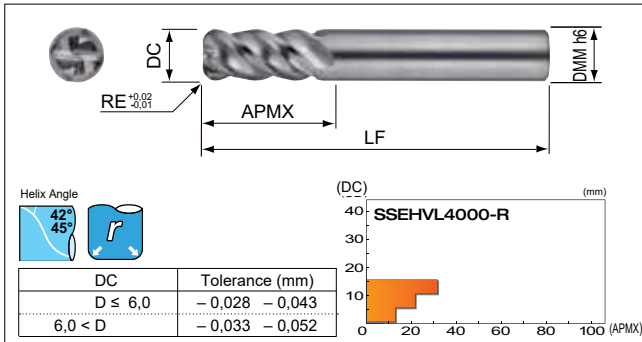

Carbide grade: EH520

# SSEH 4000-R Type

Uncoated Carbide	4	Structural Steel	Carbon Steel	Alloy Steel	Pre-hardened Steel	Tempered Die Steel	Hardened Steel			Stainless Steel	Ti Alloy / Heat Resistant Alloy	Cast Iron	Al Alloy	Cu Alloy	Graphite
							45-55 HRC	55-60 HRC	60-65 HRC						

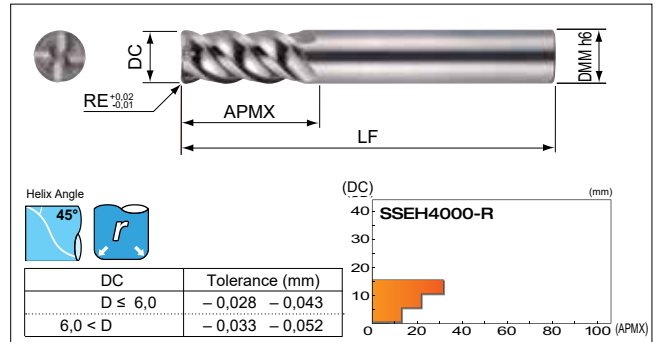

Carbide grade: EH520

## Endmills

(mm)

Cat. No.	Stock	DC	APMX	LU	LF	DMM
SSEHVL 4045-R05		4,5	0,5	12	50	6
SSEHVL 4045-R10		4,5	1,0	12	50	6
SSEHVL 4050-R05		5,0	0,5	13	60	6
SSEHVL 4050-R10	○	5,0	1,0	13	60	6
SSEHVL 4060-R10	○	6,0	1,0	13	60	6
SSEHVL 4080-R10	○	8,0	1,0	19	80	8
SSEHVL 4100-R10	○	10,0	1,0	22	90	10
SSEHVL 4100-R30	○	10,0	3,0	22	90	10
SSEHVL 4120-R10	●	12,0	1,0	26	90	12
SSEHVL 4120-R30	●	12,0	3,0	26	90	12
SSEHVL 4160-R10	○	16,0	1,0	32	115	16
SSEHVL 4160-R30	●	16,0	3,0	32	115	16

## Endmills

(mm)

Cat. No.	Stock	DC	APMX	LU	LF	DMM
SSEH 4045-R05		4,5	0,5	12	50	6
SSEH 4045-R10		4,5	1,0	12	50	6
SSEH 4050-R05		5,0	0,5	13	60	6
SSEH 4050-R10		5,0	1,0	13	60	6
SSEH 4060-R10	○	6,0	1,0	13	60	6
SSEH 4080-R10		8,0	1,0	19	80	8
SSEH 4100-R10		10,0	1,0	22	90	10
SSEH 4100-R30	○	10,0	3,0	22	90	10
SSEH 4120-R10	○	12,0	1,0	26	90	12
SSEH 4120-R30	○	12,0	3,0	26	90	12
SSEH 4160-R10		16,0	1,0	32	115	16
SSEH 4160-R30	●	16,0	3,0	32	115	16

## Characteristics / Application

- For stable machining, a more rigid machine is recommended.
- Wet machining is recommended for stainless steel and heat resistant alloy applications.
- If cutting noise and vibration are present, please change the cutting conditions accordingly.

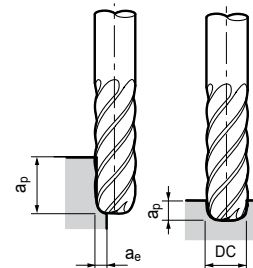

### Shoulder Milling

Work Material	Stainless Steel		Titanium Alloy		Heat Resisive Steel	
	Spindle Speed (rpm)	Feed Rate (mm/min)	Spindle Speed (rpm)	Feed Rate (mm/min)	Spindle Speed (rpm)	Feed Rate (mm/min)
DC (mm)						
4,5	2.300	120	4.600	370	1.600	130
5,0	2.000	130	4.100	410	1.500	150
6,0	1.700	130	3.400	400	1.200	140
8,0	1.300	130	2.600	360	900	130
10,0	1.000	130	2.100	340	700	110
12,0	800	110	1.700	300	600	100
16,0	600	90	1.300	260	500	100
Shoulder cutting	ap		1,5 DC			
	ae	0,1 DC	0,05 DC		0,05 DC	

### Shoulder Milling

Work Material	Stainless Steel		Titanium Alloy		Heat Resisive Steel	
	Spindle Speed (rpm)	Feed Rate (mm/min)	Spindle Speed (rpm)	Feed Rate (mm/min)	Spindle Speed (rpm)	Feed Rate (mm/min)
DC (mm)						
4,5	1.800	90	3.500	280	1.400	110
5,0	1.600	100	3.200	320	1.300	130
6,0	1.300	100	2.700	320	1.100	130
8,0	1.000	100	2.000	280	800	110
10,0	800	100	1.600	260	600	100
12,0	700	100	1.300	230	500	90
16,0	500	80	1.000	200	400	80
Shoulder cutting	ap		1,5 DC			
	ae	0,1 DC	0,05 DC		0,05 DC	

### Grooving

Work Material	Stainless Steel		Titanium Alloy		Heat Resisive Steel	
	Spindle Speed (rpm)	Feed Rate (mm/min)	Spindle Speed (rpm)	Feed Rate (mm/min)	Spindle Speed (rpm)	Feed Rate (mm/min)
DC (mm)						
4,5	1.800	50	3.200	250	1.300	110
5,0	1.600	50	2.900	290	1.200	120
6,0	1.400	50	2.400	290	1.000	120
8,0	1.000	50	1.800	250	700	90
10,0	800	50	1.400	230	600	100
12,0	600	50	1.200	210	500	90
16,0	500	40	900	180	400	80
Grooving	ap	0,3 DC	0,2 DC		0,15 DC	

### Grooving

Work Material	Stainless Steel		Titanium Alloy		Heat Resisive Steel	
	Spindle Speed (rpm)	Feed Rate (mm/min)	Spindle Speed (rpm)	Feed Rate (mm/min)	Spindle Speed (rpm)	Feed Rate (mm/min)
DC (mm)						
4,5	1.400	40	2.500	200	1.100	90
5,0	1.300	40	2.200	220	1.000	100
6,0	1.100	40	1.900	230	800	100
8,0	800	40	1.400	200	600	80
10,0	600	40	1.100	180	500	80
12,0	500	40	900	160	400	70
16,0	400	30	700	140	300	60
Grooving	ap	0,3 DC	0,2 DC		0,15 DC	

# Solid Carbide Spiral Endmills SSM 2000 Type ( $\phi 0,2-\phi 4,3$ )

# Solid Carbide Spiral Endmills SSM 2000 Type ( $\phi 4,4-\phi 8,5$ )

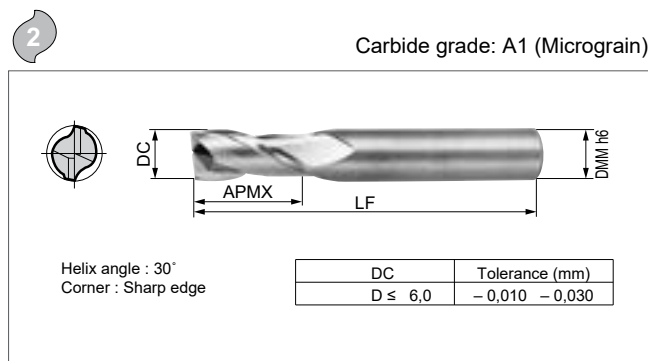
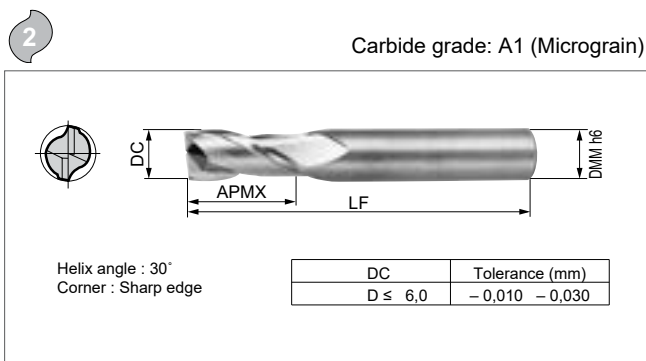

## Endmills (mm)

## Endmills (mm)

Cat. No.	Stock	DC	APMX	LF	DMM
SSM 2002	○	0,2	0,5	40	3
2003	●	0,3	1,0	40	3
2004	●	0,4	1,0	40	3
2005	●	0,5	1,5	40	3
SSM 2006	●	0,6	1,5	40	3
2007	●	0,7	1,5	40	3
2008	●	0,8	2,0	40	3
2009	○	0,9	2,0	40	3
2010	●	1,0	3,0	40	4
SSM 2011	○	1,1	3,0	40	4
2012	○	1,2	3,0	40	4
2013	○	1,3	3,0	40	4
2014	○	1,4	3,0	40	4
2015	●	1,5	5,0	40	4
SSM 2016	○	1,6	5,0	40	4
2017	○	1,7	5,0	40	4
2018	○	1,8	5,0	40	4
2019	○	1,9	5,0	40	4
2020	●	2,0	6,0	40	4
SSM 2021	○	2,1	6,0	40	4
2022	○	2,2	6,0	40	4
2023	○	2,3	6,0	40	4
2024	○	2,4	6,0	40	4
2025	●	2,5	8,0	40	4
SSM 2026	○	2,6	8,0	40	4
2027	●	2,7	8,0	40	4
2028	○	2,8	8,0	40	4
2029	○	2,9	8,0	40	4
2030	●	3,0	8,0	45	6
SSM 2031	○	3,1	8,0	45	6
2032	○	3,2	8,0	45	6
2033	○	3,3	8,0	45	6
2034	○	3,4	8,0	45	6
2035	●	3,5	8,0	45	6
SSM 2036	○	3,6	10,0	45	6
2037	○	3,7	10,0	45	6
2038	○	3,8	10,0	45	6
2039	○	3,9	10,0	45	6
2040	●	4,0	10,0	45	6
SSM 2041	○	4,1	10,0	45	6
2042	○	4,2	10,0	45	6
2043	○	4,3	10,0	45	6

Cat. No.	Stock	DC	APMX	LF	DMM
SSM 2044	○	4,4	10	45	6
2045	○	4,5	10	45	6
SSM 2046	○	4,6	12	50	6
2047	○	4,7	12	50	6
2048	○	4,8	12	50	6
2049	○	4,9	12	50	6
2050	●	5,0	12	50	6
SSM 2051	○	5,1	12	50	6
2052	○	5,2	12	50	6
2053	○	5,3	12	50	6
2054	○	5,4	12	50	6
2055	○	5,5	12	50	6
SSM 2056	○	5,6	12	50	6
2057	○	5,7	12	50	6
2058	○	5,8	12	50	6
2059	○	5,9	12	50	6
2060	●	6,0	12	50	6
SSM 2061	○	6,1	12	50	6
2062	○	6,2	12	50	6
2063	○	6,3	12	50	6
2064	○	6,4	12	50	6
2065	○	6,5	12	50	8
SSM 2066	○	6,6	15	55	8
2067	○	6,7	15	55	8
2068	○	6,8	15	55	8
2069	○	6,9	15	55	8
2070	●	7,0	15	55	8
SSM 2071	○	7,1	15	55	8
2072	○	7,2	15	55	8
2073	○	7,3	15	55	8
2074	○	7,4	15	55	8
2075	●	7,5	15	55	8
SSM 2076	○	7,6	15	55	8
2077	○	7,7	15	55	8
2078	○	7,8	15	55	8
2079	○	7,9	15	55	8
2080	●	8,0	15	55	8
SSM 2081	○	8,1	15	55	8
2082	○	8,2	15	55	8
2083	○	8,3	15	55	8
2084	○	8,4	15	55	8
2085	●	8,5	15	55	10

Uncoated Endmills

Recommended Conditions (Slotting) DC <  $\phi 3$ ;  $a_p = 0,5 \times DC$   
DC  $\geq \phi 3$ ;  $a_p = 1,0 \times DC$

DC	Material	Carbon steel, Alloy steel			Cast iron
		(BelowHRC30)	(BelowHRC40)	(BelowHRC45)	
0,2-0,9	$v_c$	40-50-60	30-40-50	20-30-40	40-50-60
	$f_z$	-0,002	-0,002	-0,001	0,002-0,004
1,0-2,9	$v_c$	40-50-60	30-40-50	20-30-40	40-50-60
	$f_z$	0,003-0,010	0,003-0,010	0,002-0,005	0,005-0,017
3,0-4,9	$v_c$	40-50-60	30-40-50	20-30-40	40-50-60
	$f_z$	0,012-0,024	0,012-0,024	0,006-0,011	0,018-0,040

$v_c = m/min$   $f_z = mm/tooth$

Recommended Conditions (Slotting) DC  $\geq \phi 3$ ;  $a_p = 1,0 \times DC$

DC	Material	Carbon steel, Alloy steel			Cast iron
		(BelowHRC30)	(BelowHRC40)	(BelowHRC45)	
5-5,9	$v_c$	40-50-60	30-40-50	20-30-40	40-50-60
	$f_z$	0,012-0,024	0,012-0,024	0,006-0,011	0,018-0,040
6-8,9	$v_c$	40-50-60	30-40-50	20-30-40	40-50-60
	$f_z$	0,025-0,050	0,025-0,050	0,013-0,025	0,045-0,105

$v_c = m/min$   $f_z = mm/tooth$

# Solid Carbide Spiral Endmills SSM 2000 Type (ø8,6-ø30)

2

Carbide grade: A1 (Micrograin)

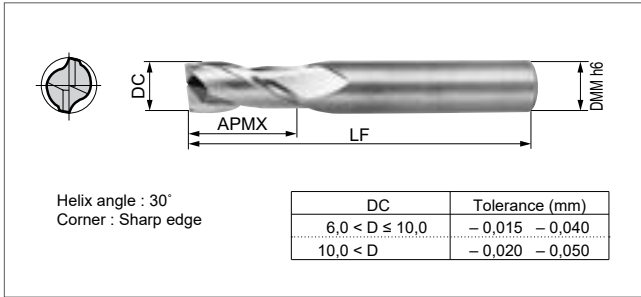

## Endmills

(mm)

Cat. No.	Stock	DC	APMX	LF	DMM
SSM 2086	○	8,6	15	55	10
2087		8,7	15	55	10
2088		8,8	15	55	10
2089		8,9	15	55	10
2090	●	9,0	15	55	10
SSM 2091		9,1	15	55	10
2092	○	9,2	15	55	10
2093		9,3	15	55	10
2094		9,4	15	55	10
2095		9,5	15	55	10
SSM 2096		9,6	18	65	10
2097		9,7	18	65	10
2098		9,8	18	65	10
2099		9,9	18	65	10
2100	●	10,0	18	65	10
SSM 2105		10,5	18	70	12
2110		11,0	18	70	12
2115	○	11,5	18	70	12
2120	●	12,0	18	70	12
2125		12,5	20	80	16
SSM 2130		13,0	20	80	16
2135	○	13,5		80	16
2140	●	14,0	20	80	16
2145		14,5	25	80	16
2150		15,0	25	80	16
SSM 2155		15,5	35	90	16
2160	●	16,0	35	90	16
2165		16,5	35	90	20
2170	●	17,0	35	90	20
2175	○	17,5	40	105	20
SSM 2180		18,0	40	105	20
2185		18,5	40	105	20
2190		19,0	40	105	20
2195		19,5	40	105	20
2200	●	20,0	40	105	20
SSM 2210	○	21,0	40	105	25
2220		22,0	40		25
2230			45	115	25
2240		24,0	45	115	25
2250	○		50		25
SSM 2300			55	130	32

## Recommended Conditions

(Slotting) DC ≥ ø3; a<sub>p</sub> = 1,0 x DC

DC	Material	Carbon steel, Alloy steel			Cast iron
		(BelowHRC30)	(BelowHRC40)	(BelowHRC45)	
9-12,5	v <sub>c</sub>	40-50-60	30-40-50	20-30-40	40-50-60
	f <sub>z</sub>	0,025-0,050	0,025-0,050	0,013-0,025	0,045-0,105
13-19,5	v <sub>c</sub>	40-50-60	30-40-50	20-30-40	40-50-60
	f <sub>z</sub>	0,055-0,085	0,055-0,085	0,030-0,050	0,110-0,170
20-30	v <sub>c</sub>	40-50-60	30-40-50	20-30-40	40-50-60
	f <sub>z</sub>	0,095-0,120	0,095-0,120	0,055-0,070	0,185-0,260

v<sub>c</sub> = m/min f<sub>z</sub> = mm/tooth

# Solid Carbide Spiral Endmills SSM 4000 Type (ø1,5-ø25)

4

Carbide grade: A1 (Micrograin)

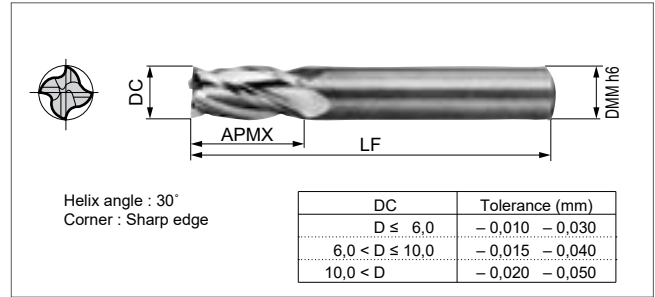

## Endmills

(mm)

Cat. No.	Stock	DC	APMX	LF	DMM
SSM 4015	●	1,5	5	40	4
4020	●	2,0	6	40	4
4025	○	2,5	8	40	4
4030	●	3,0	8	45	6
4035		3,5	8	45	6
SSM 4040	●	4,0	10	45	6
4045		4,5	10	45	6
4050	●	5,0	12	50	6
4055		5,5	12	50	6
4060	●	6,0	12	50	6
SSM 4065		6,5	12	50	8
4070	●	7,0	15	55	8
4075	●	7,5	15	55	8
4080	●	8,0	15	55	8
4085	○	8,5	15	55	10
SSM 4090	●	9,0	15	55	10
4095	●	9,5	15	55	10
4100	●	10,0	18	65	10
4105		10,5	18	65	12
4110		11,0	18	70	12
SSM 4120	●	12,0	18	70	12
4130		13,0	20	80	16
4140	●	14,0	20	80	16
4150		15,0	25	80	16
4160	●	16,0	35	90	16
SSM 4170		17,0	35	90	20
4180		18,0	40	105	20
4190		19,0	40	105	20
4200	●	20,0	40	105	20
4210		21,0	40	105	25
SSM 4220		22,0	40	105	25
4230		23,0	45	115	25
4240		24,0	45	115	25
4250		25,0	50	120	25

## Recommended Conditions

(Shoulder processing) a<sub>p</sub> = 1,5 x DC

a<sub>e</sub> = 0,1 x DC

DC	Material	Carbon steel, Alloy steel			Cast iron
		(BelowHRC30)	(BelowHRC40)	(BelowHRC45)	
1 ~ 2,9	v <sub>c</sub>	40-50-60	30-40-50	20-30-40	40-50-60
	f <sub>z</sub>	0,004-0,017	0,004-0,017	0,002-0,008	0,008-0,020
3 ~ 5,9	v <sub>c</sub>	40-50-60	30-40-50	20-30-40	40-50-60
	f <sub>z</sub>	0,018-0,036	0,018-0,036	0,009-0,018	0,027-0,060
6 ~ 12,9	v <sub>c</sub>	40-50-60	30-40-50	20-30-40	40-50-60
	f <sub>z</sub>	0,038-0,070	0,038-0,070	0,019-0,035	0,065-0,157
13 ~ 19,9	v <sub>c</sub>	40-50-60	30-40-50	20-30-40	40-50-60
	f <sub>z</sub>	0,075-0,125	0,075-0,125	0,040-0,075	0,160-0,250
20 ~	v <sub>c</sub>	40-50-60	30-40-50	20-30-40	40-50-60
	f <sub>z</sub>	0,135-0,170	0,135-0,170	0,085-0,110	0,257-0,390

v<sub>c</sub> = m/min f<sub>z</sub> = mm/tooth

Uncoated Endmills

# SUMIBORON "Helical Master" BNES Type

Spiral CBN Endmill for Hardened Steel

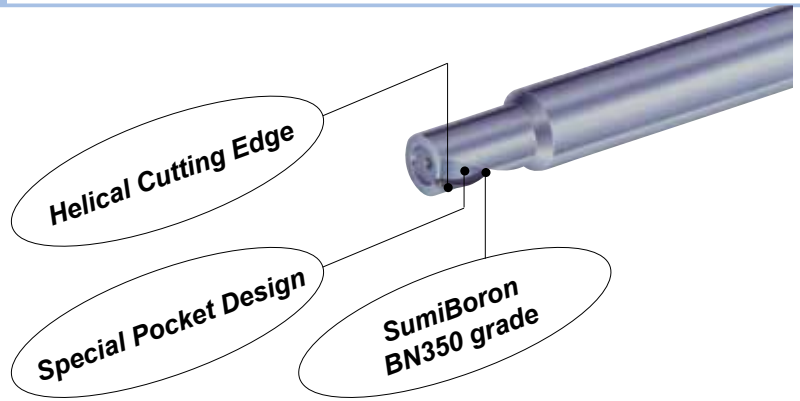

## Endmills BNES Type with 1 Spiral Flute

Cat. No.	Stock	Dimensions (mm)				
	BN350	DC	DMM	APMX	LU	LF
BNES 1060	○	6,0	10	7,0	11	60
1080	○	8,0	10	10,0	14	70
1100	○	10,0	12	12,0	17	75
1120	○	12,0	12	14,0	20	80
1140	○	14,0	16	16,0	21,5	80

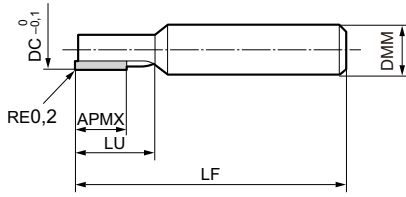

Helix angle : 15°  
right-hand cut, right-hand helix

## Recommended Cutting Conditions

Cutting speed:  $v_c$  (m/min), Spindle revolutions:  $n$  (rpm), Feed per tooth:  $f_z$  (mm/tooth), Feed speed:  $v_f$  (mm/min)

Tooling example	DC	Hardened steel (HRC 50–57)				Hardened steel (HRC 58–65)		
		$v_c = 100\text{--}170$ m/min				$v_c = 80\text{--}150$ m/min		
		$a_e \leq 0,1$ mm	$n = 4000\text{--}9000$	$V_f$ (mm/min) = 240–540		$a_e \leq 0,08$ mm	$n = 3200\text{--}8000$	$V_f$ (mm/min) = 150–370
	6–8	$a_e \leq 0,15$ mm	$n = 2700\text{--}5400$	$V_f$ (mm/min) = 180–360	$a_e \leq 0,12$ mm	$n = 2100\text{--}4800$	$V_f$ (mm/min) = 120–270	
	10–12	$a_e \leq 0,2$ mm	$n = 2000\text{--}3800$	$V_f$ (mm/min) = 140–260	$a_e \leq 0,15$ mm	$n = 1600\text{--}3400$	$V_f$ (mm/min) = 110–230	
	14–16							

Recommendation: Dry cutting (Air coolant)  
Down-cut milling  
Minimise the overhang  
Use a rigid machine

## Performance

### Long Tool Life and High Efficiency

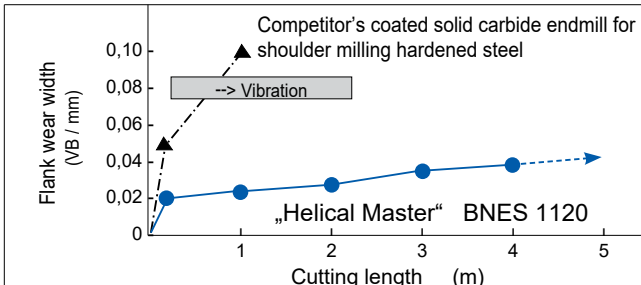

Work material: X155CrVMo12-1  
Hardness: HRC 60

Cutting data:  
 $v_c = 100$  m/min (**Helical Master**)  
 $v_c = 40$  m/min (Competitor's coated solid carbide endmill)  
 $v_f = 186$  mm/min

Down-cut milling  
Dry cutting

### Excellent Surface Roughness

"Helical Master" BNES 1080  $\phi 8,0$

Conventional straight flute CBN endmill,  $\phi 8,0$

Work material: 15Cr3  
Hardness: HRC 55–58  
Cutting data:  $v_c = 130$  m/min  
 $v_f = 310$  mm/min

Down-cut milling  
Dry cutting

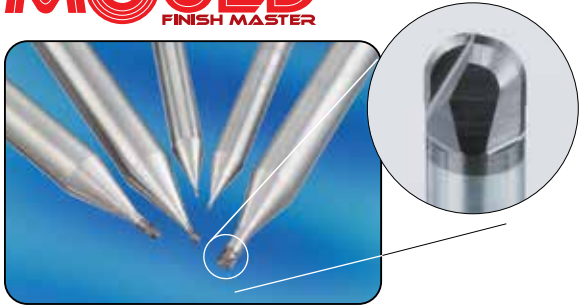

■ Characteristics / Application

- High precision machining of hardened steels < HRC70 with long tool life
- Super tough grade SUMIBORON BN350 prevents chipping of the cutting edge
- RE accuracy : ±0,005 mm

■ Endmills

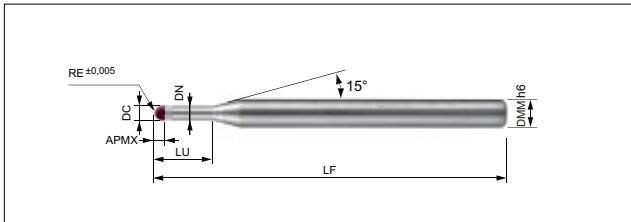

■ Identification Details

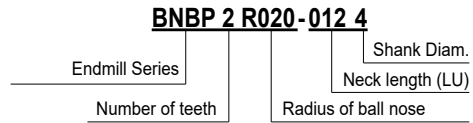

Dimensions (mm)

Cat. No.	Stock	RE	DC	APMX	LU	LF	DN	DMM
BNBP 2R0200124	●	0,20	0,4	0,3	1,2	50	0,37	4
2R0200126	●	0,20	0,4	0,3	1,2	50	0,37	6
2R0200204	○	0,20	0,4	0,3	2,0	50	0,37	4
2R0200304	○	0,20	0,4	0,3	3,0	50	0,37	4
2R0200404	○	0,20	0,4	0,3	4,0	50	0,37	4
BNBP 2R0300154	●	0,30	0,6	0,4	1,5	50	0,57	4
2R0300156	●	0,30	0,6	0,4	1,5	50	0,57	6
2R0300304	○	0,30	0,6	0,4	3,0	50	0,57	4
2R0300404	○	0,30	0,6	0,4	4,0	50	0,57	4
2R0300504	○	0,30	0,6	0,4	5,0	50	0,57	4
2R0300604	○	0,30	0,6	0,4	0,6	50	0,57	4
BNBP 2R0500254	●	0,50	1,0	0,6	2,5	50	0,97	4
2R0500256	●	0,50	1,0	0,6	2,5	50	0,97	6
2R0500304	○	0,50	1,0	0,6	3,0	50	0,97	4
2R0500404	○	0,50	1,0	0,6	4,0	50	0,97	4
2R0500604	○	0,50	1,0	0,6	0,6	50	0,97	4
2R0500804	○	0,50	1,0	0,6	8,0	50	0,97	4
BNBP 2R0750404	○	0,75	1,5	0,9	4,0	50	1,47	4
2R0750406	●	0,75	1,5	0,9	4,0	50	1,47	6
BNBP 2R1000554	●	1,00	2,0	1,4	5,5	50	1,97	4
2R1000556	●	1,00	2,0	1,4	5,5	50	1,97	6
2R1000804	○	1,00	2,0	1,4	8,0	50	1,97	4

Grade: BN350

■ Recommended Cutting Conditions

Work Material	STAVAX, NAK80, SKD61 (< 52HRC)					ELMAX, DC53, SKD11 (< 62HRC)				YXR3, SKH (< 70HRC)			
	RE (mm)	LU (mm)	Spindle Speed (min <sup>-1</sup> )	Feed Rate (mm/min)	ap (mm)	pf (mm)	Spindle Speed (min <sup>-1</sup> )	Feed Rate (mm/min)	ap (mm)	pf (mm)	Spindle Speed (min <sup>-1</sup> )	Feed Rate (mm/min)	ap (mm)
0,2	1,2	40.000	1.000	0,005	0,010	40.000	800	0,005	0,010	40.000	600	0,005	0,005
	2,0	40.000	800	0,005	0,010	40.000	600	0,005	0,010	40.000	400	0,005	0,005
	3,0	40.000	600	0,005	0,010	40.000	500	0,005	0,010	40.000	300	0,005	0,005
	4,0	40.000	500	0,005	0,010	40.000	400	0,005	0,005	40.000	200	0,005	0,005
0,3	1,5	40.000	1.600	0,020	0,020	40.000	1.400	0,010	0,020	40.000	1.200	0,010	0,020
	2,0	40.000	1.500	0,010	0,020	40.000	1.300	0,010	0,020	40.000	1.100	0,010	0,010
	3,0	40.000	1.400	0,010	0,020	40.000	1.200	0,010	0,020	40.000	1.000	0,010	0,010
	4,0	30.000	1.200	0,010	0,010	30.000	1.000	0,010	0,010	30.000	700	0,005	0,010
	5,0	30.000	800	0,010	0,010	30.000	700	0,005	0,010	30.000	600	0,005	0,005
0,5	2,5	40.000	2.800	0,040	0,050	40.000	2.800	0,030	0,040	40.000	2.200	0,020	0,030
	3,0	40.000	2.600	0,040	0,050	40.000	2.600	0,030	0,040	40.000	2.100	0,020	0,030
	4,0	40.000	2.400	0,030	0,050	40.000	2.400	0,020	0,030	40.000	2.000	0,020	0,020
	6,0	25.000	1.500	0,020	0,030	25.000	1.500	0,010	0,020	25.000	1.300	0,010	0,010
	8,0	16.000	1.200	0,020	0,020	16.000	1.100	0,010	0,020	16.000	850	0,010	0,010
0,75	4,0	32.000	2.400	0,030	0,030	32.000	2.200	0,020	0,030	32.000	2.000	0,020	0,020
	1,0	5,5	40.000	4.000	0,050	0,050	40.000	4.000	0,030	0,030	40.000	3.000	0,020
1,0	8,0	32.000	3.000	0,030	0,050	32.000	2.600	0,020	0,030	32.000	2.200	0,010	0,020

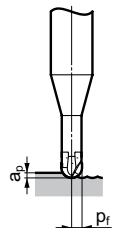

Important Notes

- (1) For stable machining, a more rigid machine is recommended.
- (2) Air blast or oil mist coolant is recommended.
- (3) Shorten overhang as much as possible.

Uncoated Endmills



# SUMIDIA "MOULD Finish Master" NPDRS Type

## SUMIDIA Binderless Radius Endmill NPDRS Type

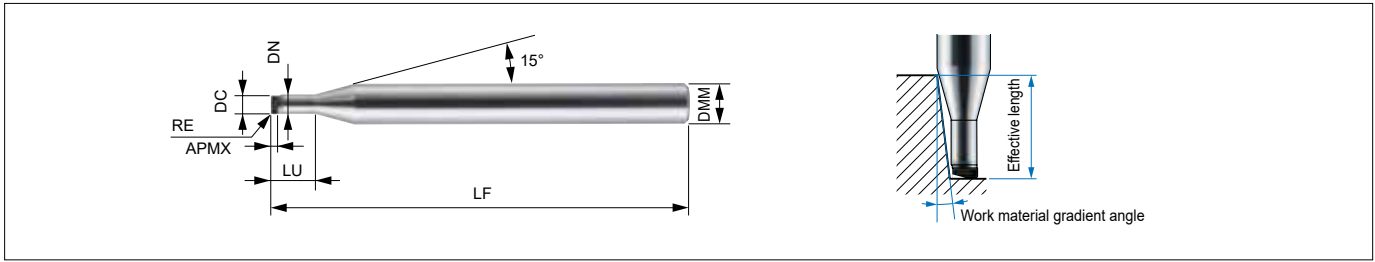

### NPDRS Type Body (for Standard Finishing)

Cat. No.	Stock	Dimensions (mm)							Real effective length with respect to work material gradient angle				
	NPD10	DC	RE	APMX	LU	LF	DN	DMM	0,5°	1°	1,5°	2°	3°
NPDRS 1020 R002-006	○	0,2	0,02	0,10	0,6	40	0,175	4	0,61	0,62	0,63	0,64	0,66
1020 R005-006	○	0,2	0,05	0,10	0,6	40	0,175	4	0,61	0,62	0,63	0,64	0,66
1030 R002-010	○	0,3	0,02	0,15	1,0	40	0,27	4	1,01	1,03	1,04	1,06	1,09
1030 R005-010	○	0,3	0,05	0,15	1,0	40	0,27	4	1,01	1,03	1,04	1,06	1,09
1050 R005-015	○	0,5	0,05	0,25	1,5	40	0,47	4	1,61	1,66	1,72	1,78	1,92
NPDRS 1050 R010-015	○	0,5	0,10	0,25	1,5	40	0,47	4	1,61	1,66	1,71	1,77	1,91
1100 R005-030	○	1,0	0,05	0,55	3,0	40	0,95	4	3,40	3,52	3,65	3,78	4,08
1100 R010-030	○	1,0	0,10	0,55	3,0	40	0,95	4	3,40	3,52	3,64	3,77	4,07
1100 R020-030	○	1,0	0,20	0,55	3,0	40	0,95	4	3,40	3,51	3,63	3,76	4,05
1200 R005-040	○	2,0	0,05	0,55	4,0	40	1,95	4	4,44	4,59	4,75	4,93	5,33
NPDRS 1200 R010-040	○	2,0	0,10	0,55	4,0	40	1,95	4	4,43	4,59	4,75	4,92	5,31
1200 R020-040	○	2,0	0,20	0,55	4,0	40	1,95	4	4,43	4,58	4,74	4,91	5,29

### Identification Details

<b>NPDR</b>	<b>S</b>	<b>1</b>	<b>020</b>	<b>R002</b>	<b>- 006</b>
Series Code	For standard finishing	No. of flutes	Cutting diameter	Corner radius	Length below neck

### Cutting Diameter and Nose Radius Combinations

DC	RE 0,02	RE 0,05	RE 0,1	RE 0,2
0,2	○	○		
0,3	○	○		
0,5		○	○	
1,0		○	○	○
2,0		○	○	○

### Recommended Cutting Conditions

- Use a machine with high rigidity for stable cutting.
- Non-water soluble coolant recommended. Supply as a mist or external coolant. Take fire prevention precautions to avoid fire hazards caused by sparks igniting during machining or tool breakage.
- Shorten overhang as much as possible.
- Adjust cutting conditions as necessary as machine rigidity and other conditions may vary.
- Depth of cut shown in the table of conditions are maximum depths. Adjust the actual depth of cut to the desired machined surface finish.

Work Material		Carbide			
DC (mm)	LU (mm)	Spindle Speed (min <sup>-1</sup> )	Feed Rate (mm/min)	a <sub>p</sub> (mm)	Pr (mm)
0,2	0,10	40.000	100	0,001	0,001
0,3	0,15	40.000	150	0,002	0,001
0,5	0,25	40.000	200	0,003	0,001
1,0	0,55	40.000	400	0,005	0,003
2,0	0,55	40.000	600	0,010	0,005



○ = Japan stock

# SUMIDIA "MOULD Finish Master" NPDB(S) Type

## SUMIDIA Binderless Ballnose Endmill NPDBS Type / NPDB Type

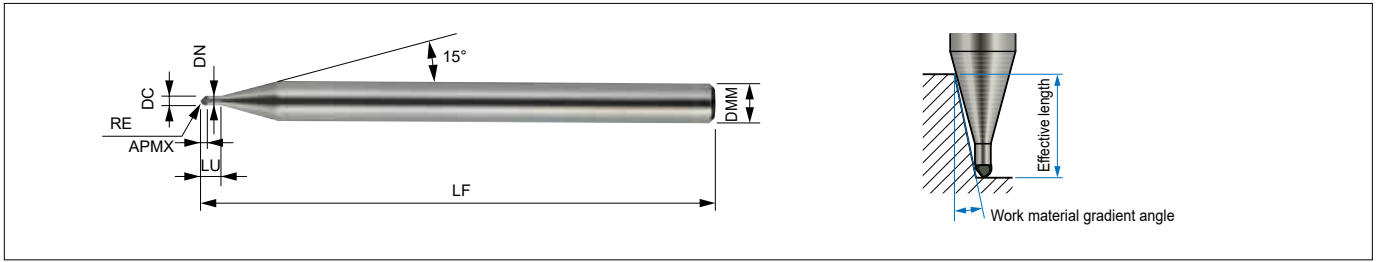

### NPDBS Type Body (for Standard Finishing)

Cat. No.	Stock NPD10	Dimensions (mm)							Real effective length with respect to work material gradient angle				
		RE	DC	APMX	LU	LF	DN	DMM	0,5°	1°	1,5°	2°	3°
NPDBS 1010-004	○	0,1	0,2	0,1	0,4	40	0,18	4	0,44	0,45	0,46	0,47	0,49
1020-008	○	0,2	0,4	0,2	0,8	40	0,38	4	0,83	0,84	0,85	0,86	0,89
1030-010	○	0,3	0,6	0,3	1,0	40	0,58	4	1,05	1,08	1,10	1,13	1,20
1050-020	○	0,5	1,0	0,5	2,0	40	0,95	4	2,08	2,13	2,19	2,24	2,38
1100-030	○	1,0	2,0	1,0	3,0	40	1,95	4	3,13	3,20	3,27	3,35	3,53

### NPDB Type Body (for Precision Finishing)

Cat. No.	Stock NPD10	Dimensions (mm)							Real effective length with respect to work material gradient angle				
		RE	DC	APMX	LU	LF	DN	DMM	0,5°	1°	1,5°	2°	3°
NPDB 1010-004	○	0,1	0,2	0,1	0,4	40	0,18	4	0,44	0,45	0,46	0,47	0,49
1020-008	○	0,2	0,4	0,2	0,8	40	0,38	4	0,83	0,84	0,85	0,86	0,89
1030-010	○	0,3	0,6	0,3	1,0	40	0,58	4	1,05	1,08	1,10	1,13	1,20
1050-020	○	0,5	1,0	0,5	2,0	40	0,95	4	2,08	2,13	2,19	2,24	2,38
1100-030	○	1,0	2,0	1,0	3,0	40	1,95	4	3,13	3,20	3,27	3,35	3,53

### Identification Details

**NPDB (S) 1 030 - 010**

Series Code      For standard finishing      No. of flutes      Ballnose radius      Length below neck

### Recommended Cutting Conditions

- Use a machine with high rigidity for stable cutting.
- Non-water soluble coolant recommended. Supply as a mist or external coolant.  
Take fire prevention precautions to avoid fire hazards caused by sparks igniting during machining or tool breakage.
- Shorten overhang as much as possible.
- Adjust cutting conditions as necessary as machine rigidity and other conditions may vary.
- Depth of cut shown in the table of conditions are maximum depths. Adjust the actual depth of cut to the desired machined surface finish.

#### ● Flat Surface Finishing

Work Material		Carbide			
RE (mm)	LU (mm)	Spindle Speed (min <sup>-1</sup> )	Feed Rate (mm/min)	a <sub>p</sub> (mm)	ρ <sub>f</sub> (mm)
0,1	0,4	40.000	100	0,001	0,001
0,2	0,8	40.000	150	0,001	0,001
0,3	1,0	40.000	200	0,001	0,001
0,5	2,0	40.000	400	0,001	0,003
1,0	3,0	40.000	600	0,001	0,005

#### ● Copy Finishing

Work Material		Carbide			
RE (mm)	LU (mm)	Spindle Speed (min <sup>-1</sup> )	Feed Rate (mm/min)	a <sub>p</sub> (mm)	ρ <sub>f</sub> (mm)
0,1	0,4	40.000	100	0,001	0,001
0,2	0,8	40.000	150	0,002	0,001
0,3	1,0	40.000	200	0,003	0,001
0,5	2,0	40.000	400	0,005	0,003
1,0	3,0	40.000	600	0,010	0,005

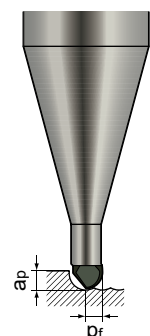



# K



# Multi-Drills

K1-K68



Selection Guide	<b>MULTI-DRILLS</b> .....	K2-5
<b>Solid Type Drills</b>	<b>SDP</b> ... U3/5/7-HAK .....	K6-13
	<b>SDM</b> ... U3/5-HAK .....	K14-19
	<b>MDW</b> ... GS 2/4 .....	K20-23
Flat MultiDrill	<b>MDF</b> .....	K24-31
Deep Hole Drills	<b>MDW</b> ... XHG S / PHT .....	K32-33
for Steels	<b>MDW</b> ... XHG S .....	K34
for Aluminium	<b>MDW</b> ... XHT A .....	K35
Pilot Hole Drills	<b>MDW</b> ... PHT .....	K34-35
AURORA COAT Drills	<b>MDW</b> ... NHGS .....	K36-37
MINI-Drills	<b>MLDH</b> ... L/P .....	K38-39
	<b>MDUS / MDSS</b> .....	K40
SUMIDIA Coated Drills	<b>MDS</b> ... SDC .....	K41
<b>Replaceable Head Type Drills</b>	<b>SMD</b> .....	K43
Drill Holder	<b>SMDH</b> ... (D) .....	K44/48/51
Drill Head for Steels	<b>SMDT</b> ... D MTL .....	K45
for Stainless Steels	<b>SMDT</b> ... D MEL .....	K46-47
for Spot Facing	<b>SMDT</b> ... MFS .....	K48-49
Large Holes	<b>SMDT</b> ... MTL .....	K50-51
<b>Insert Type Drills</b>	<b>WDX</b> (2D, 3D, 4D, 5D) .....	K52-64
Eccentric Sleeve	<b>WAS</b> .....	K65
Plunge Drills	<b>PDL</b> (2D, 3D) .....	K66-68
Multi-Function Mills	<b>PCT</b> (3D, 5D) .....	K67-68

# Multi-Drill Series



## ■ General Features

MultiDrill series is Sumitomo's original brand of high performance drills that have a special cutting edge design coupled with an advance carbide substrate.

The series has a comprehensive selection of diameters and drill lengths to cover a wide range of work materials and requirements, providing high efficiency, high precision and cost effectiveness.

## ■ Solid Carbide Type Multi-Drills Selection

	SDP ...	SDM ...	MDW ...	MDF ...	MDW ... ○○○			MLDH	MDUS / MDSS	MDS ...	
Type	...U3/5/7 -HAK (DIN)	...U3/5 -HAK (DIN)	GS 2/4	...S2D, L2D ...H3D, H5D	... PHT	... XHGS ... XHTA	... NHGS	... P / L	–	... SDC	
Page	⇒ K 6–13	⇒ K 14–19	⇒ K20–23	⇒ K24–31	⇒ K32–35		⇒ K36–37	⇒ K38–39	⇒ K40	⇒ K41	
Application	<b>PK</b>	<b>PM</b>	<b>P</b>	<b>P</b>	<b>PMKN</b>		<b>N</b>	<b>PMK</b>	<b>PMKH</b>	<b>N</b>	
Form	m7 drill DIN type		h8 drill cylindric	h8 drill cylindric		Extra long DIN type		Super Multi-Drill	Long Micro Drill	Mini Multi-Drill	Diamond Coated
Length (The ratio to øD)	3D/5D/7D	3D / 5D	2 / 4D	S2D/ L2D	H3D/ H5D	3D	10D–30D	3D/5D/10D	5/12/20/30 D	10D	3D
Coolant holes	Yes		No	No	Yes	Yes		Yes	Yes	No	No
Coating	AlCrTiN		DEX (TiAlCr/TiSi)	PVD		TiAlN	–	DLC	TiAlN	TiAlN / ZX	SUMIDIA
Diameter range	3,0–16,0		2,0–16,0	0,3–20,0	3,0–16,0	4,0–8,0	3,0–12,0	3,0–16,0	0,8–2,0	0,03–1,0	2,0–10,0

# Multi-Drill Series

## Advantages

- Unique curved flute design with proven enhanced chip formation and removal, resulting in better hole accuracy.
- High speed and high efficient drilling is made possible with the combination of a special substrate with an advanced PVD coating. (10x tool life of HSS drills, 5x the efficiency)
- Wide selection range (Diameter: 0,03–65 mm, Drilling depths L/D: 2–30)
- Other diameters and length can be asked and offered





## Brazed Carbide Type and Insert Type Multi-Drills Selection

	SMD ... ⇨ K43	WDX ...00	PDL ...00	PCT ...00
Type	 SMDT ... (D) MTL ⇨ K45, K59	WAS ....-... ⇨ K65		
Page	 SMDT ... D MEL ⇨ K46–47	⇨ K52–66	⇨ K66–68	⇨ K67–68
	 SMDT ... MFS ⇨ K49			
	 SMDH ... M-3/5/8 ⇨ K44, K48			
	 SMDH ... M/L/D ⇨ K51			
				
Application	<b>P M K</b>	<b>P M K N</b>		
Form	SMDT type carbide head	Indexable insert drill	Straight flute insert drill	Insert mill
Length (The ratio to øD)	1.5D / 3D / 5D / 8D / 12D	2D / 3D / 4D / 5D	2D / 3D	3D / 5D
Coolant holes	Yes	Yes		
Coating	TiAlN	WDXT type insert		
Diameter range	12,0–42,5	13,0–65,0	16,0–40,0	





# Multi-Drill Series Selection Guide

## ● According to Drill Types / Applications

Application		General	↔	Special
Solid Type	"Super Multi-Drill" MDS / MDW Type	m7 DIN Type "Super Multi-Drill" <b>SDP...U HAK Type</b> AlCrTiN coated general purpose drill with coolant holes  Ø 3,0–16 mm L/D: 3, 5, 7 ⇒ K6–13	"Super Multi-Drill" <b>MDW...GS Type</b> DEX (TiAlCr/TiSi) coated general purpose drill without coolant holes  Ø 2,0–16 mm L/D: –2, –4 ⇒ K20–23	—
		—	—	"Super Multi-Drill" <b>MDS...D Type</b> Hardened Steel Exotic Metals  Ø 1,0–16,1 mm L/D: –3 (Stock in Japan)

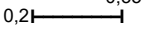
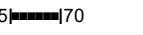
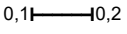
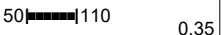
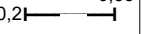
## ■ Recommended Cutting Conditions by Work Materials



Drill		Work			
		Steel	Stainless Steel	Cast Iron	Non-ferrous Metals
Solid Type	<b>SDP...U HAK</b> <b>MDW...GS</b>	50  120 0,2  0,35	15  70 0,1  0,2	50  110 0,2  0,35	—

 Cutting speed  $v_c$  (m/min)  
 Feed  $f$  (mm/rev)



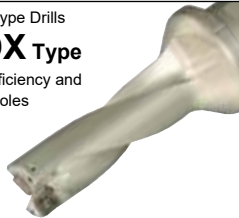
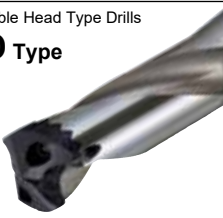

# Multi-Drill Series Selection Guide

## ● According to Drill Types / Applications



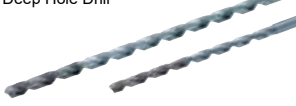
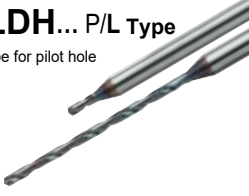

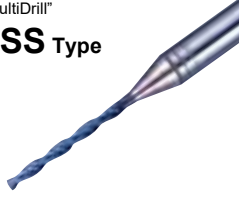

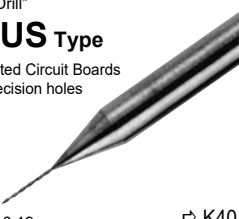



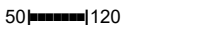
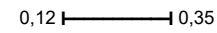

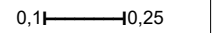

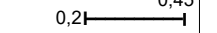
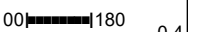
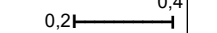

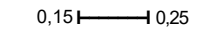

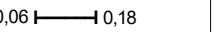
Application	General	↔	Special
-------------	---------	---	---------

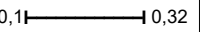

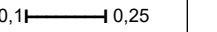
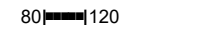
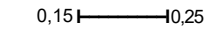
Indexable Drills	Insert Type Drills <b>WDX Type</b> High Efficiency and Deep Holes  Ø 13,0–65,0 mm L/D: 2, 3, 4, 5 ⇨ K52–64	Replaceable Head Type Drills <b>SMD Type</b>  Ø 12,0–42,5 mm L/D: 3, 5, 8 ⇨ K43–51	"Multi-Function" Types <b>PDL &amp; PCT</b> Plunge Drills and Plunge Mills  Ø 16,0–40,0 mm L/D: 2, 3, 5 ⇨ K66–68
------------------	---	---	---

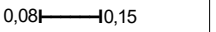
Application	Deep Hole	Very Small Hole	Precision Hole
-------------	-----------	-----------------	----------------

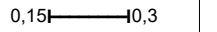
Special Purpose Drills	"Super Long Multi-Drill" <b>MDW...XHGS/XHTA Type</b> New General Purpose Deep Hole Drill  Ø 4,0–12,0 mm L/D: 10/15/20/25/30 ⇨ K32–35	"Long Micro Drill" <b>MLDH... P/L Type</b> "P" type for pilot hole  Ø 0,8–2,0 mm L/D: 5/12/20/30 ⇨ K38–39	AURORA-Coat Drill <b>MDW...NHGS Type</b> For Aluminium Alloy  Ø 3,0–16,0 mm L/D: 3 / 5 / 10 ⇨ K36–37
	—	"Mini-MultiDrill" <b>MDSS Type</b>  Ø 0,20–1,00 mm L/D: 10 ⇨ K40	"SUMI-DIA" coated Drill <b>MDS...SDC Type</b> For Aluminium & CFRP*  CFRP* (Carbon Fibre Reinforced Plastic) Ø 2–10 mm L/D: –3 ⇨ K41
	—	"Micro Drill" <b>MDUS Type</b> For Printed Circuit Boards High precision holes  Ø 0,05–0,19 mm L/D: –8 ⇨ K40	—

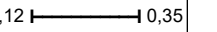
## ■ Recommended Cutting Conditions by Work Materials

Drill \ Work	Steel	Stainless Steel	Cast Iron	Non-ferrous Metals
<b>SMD (Ø 20)</b>	50  120 0,12  0,35	50  90 0,1  0,25	50  100 0,2  0,45	100  180 0,2  0,4
<b>WDX (Ø 18)</b>	100  220 0,15  0,25	80  180 0,06  0,18	120  200 0,1  0,32	100  200 0,1  0,25
<b>MDW...XHT (Ø 5)</b>	80  120 0,15  0,25	30  60 0,08  0,15	50  90 0,15  0,3	80  160 0,12  0,35

 Cutting speed  $v_c$  (m/min)  
 Feed  $f$  (mm/rev)

# SumiDrill Power Series SDP Type (DIN)

AlCrTiN Coated Solid Carbide Drills to DIN 6537

## General Features

New designed double margin  
Excellent hole accuracy

Shank

DIN 6535 HAK

Sumi-Power Coating

Excellent wear resistance  
and anti-adhesion

Elliptical flute design

Improved chip formation  
and chip evacuation

Curved cutting edge,  
optimized edge preparation

Low cutting force

Coating Structure



Improved anti-adhesion  
AlCrTiN lubricant layer  
coating with high Al content  
improves friction condition.

High wear resistance  
Tough and hard  
AlCrTiN super multilayer

Substrate

Stock Size

Ø 3,0 – Ø 12,0  
Increment 0,1 mm

Ø 12,1 – Ø 16,0  
Standard diameter





## Advantages

- The specific and optimum solution for a wide range of application conditions
- Top performance parameters, maximum feed and stable long tool life
- Double margin design for high-precision holes
- Good balance of high wear resistance and toughness
- Curved cutting edge - ideal for removing chips
- Reliable and high productivity performance

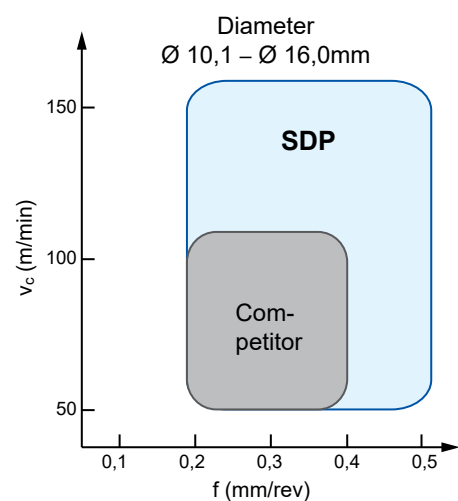
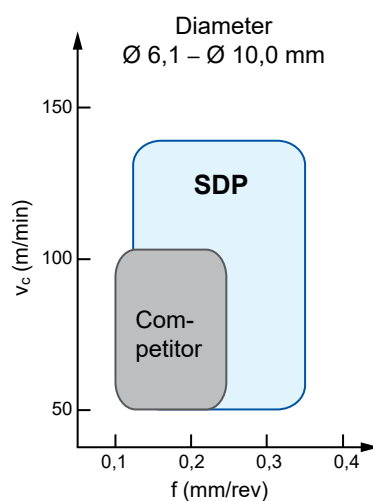
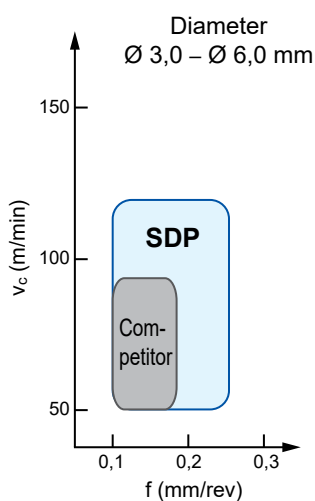
## Application Range



## Maximum Feed Rate Result

Feed Rate (mm/rev)	0,30	0,40	0,50	0,55	0,60	0,65	0,70	0,75	0,80
SDP Type	OK	OK	OK	OK	OK				
Competitor	OK	 Breakage!							

Internal test conditions

Drill: Ø 4, L/D = 5  
Work Material: Carbon Steel (C50)  
Cutting Data:  $v_c = 80$  m/rev,  $a_p = 18$  mm

## Comparison of Tool Life

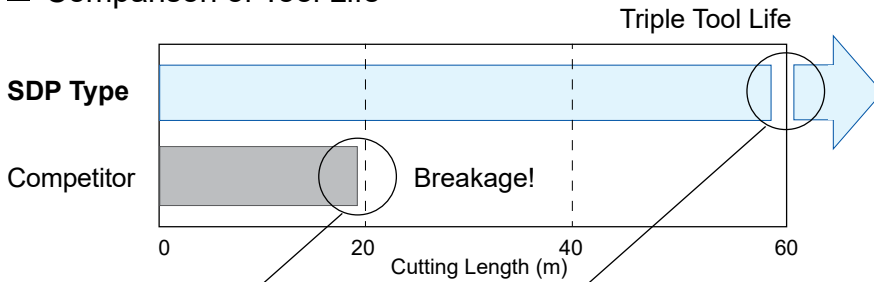

Drill: Ø 8, L/D = 5  
Work Material: Carbon Steel (C50)  
Cutting Data:  $v_c = 80$  m/min,  $f = 0,15$  mm/rev,  $a_p = 38$  mm, Through hole, Internal coolant

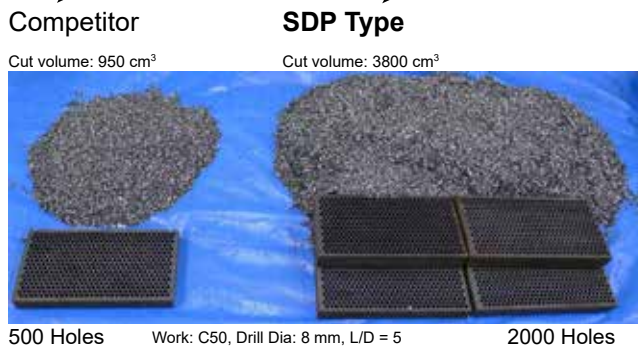





### SDP Type



### Competitor

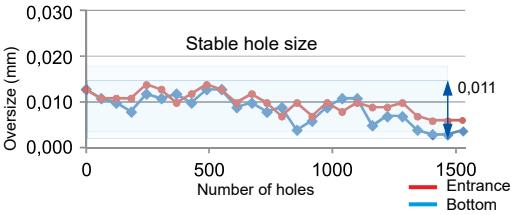

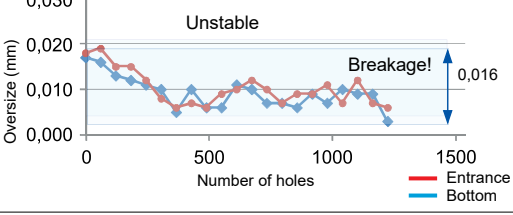
## Excellent Hole Accuracy

	Hole Accuracy	Chip Shape
SDP Type	 	Compact cutting chips 
Competitor	 	Longer cutting chips 

Drill: Ø 8, L/D = 5  
Workpiece: Carbon Steel (C50)  
Cutting Data:  $v_c = 80$  m/min,  $f = 0,25$  mm/rev,  $a_p = 24$  mm, Blind-hole, Internal coolant

# SumiDrill Power Series SDP (DIN) Type

AlCrTiN Coated Solid Carbide Drills to DIN 6537

## ■ Solid Carbide Drill with Internal Coolant Supply, Ø 3,0–5,6 mm, 3D / 5D / 7D

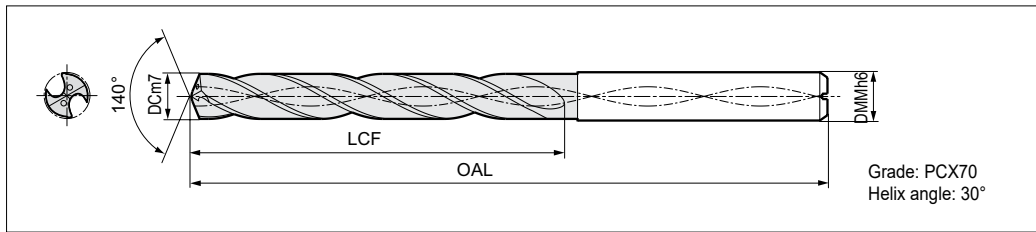

DC	L/D	Cat. No.	Stock	LU	LCF	OAL	PL	DCON
3,0	3	SDP 0300 U3 HAK	●	15,0	19,5	61,5	0,5	6,0
	5	0300 U5 HAK	●	22,0	26,5	65,5		
	7	0300 U7 HAK	●	26,0	30,5	69,5		
3,1	3	SDP 0310 U3 HAK	●	15,0	19,6	61,6	0,6	6,0
	5	0310 U5 HAK	●	22,0	26,6	65,6		
	7	0310 U7 HAK	●	26,0	30,6	69,6		
3,2	3	SDP 0320 U3 HAK	●	14,8	19,6	61,6	0,6	6,0
	5	0320 U5 HAK	●	21,8	26,6	65,6		
	7	0320 U7 HAK	●	25,8	30,6	69,6		
3,25	3	SDP 0325 U3 HAK	●	14,7	19,6	61,6	0,6	6,0
	5	0325 U5 HAK	●	21,7	26,6	65,6		
	7	0325 U7 HAK	●	25,7	30,6	69,6		
3,3	3	SDP 0330 U3 HAK	●	14,7	19,6	61,6	0,6	6,0
	5	0330 U5 HAK	●	21,7	26,6	65,6		
	7	0330 U7 HAK	●	25,7	30,6	69,6		
3,4	3	SDP 0340 U3 HAK	●	14,5	19,6	61,6	0,6	6,0
	5	0340 U5 HAK	●	21,5	26,6	65,6		
	7	0340 U7 HAK	●	31,0	36,1	74,6		
3,5	3	SDP 0350 U3 HAK	●	14,4	19,6	61,6	0,6	6,0
	5	0350 U5 HAK	●	21,4	26,6	65,6		
	7	0350 U7 HAK	●	30,9	36,1	74,6		
3,6	3	SDP 0360 U3 HAK	●	14,3	19,7	61,7	0,7	6,0
	5	0360 U5 HAK	●	21,3	26,7	65,7		
	7	0360 U7 HAK	●	30,8	36,2	74,7		
3,7	3	SDP 0370 U3 HAK	●	14,2	19,7	61,7	0,7	6,0
	5	0370 U5 HAK	●	21,2	26,7	65,7		
	7	0370 U7 HAK	●	30,7	36,2	74,7		
3,8	3	SDP 0380 U3 HAK	●	18,0	23,7	65,7	0,7	6,0
	5	0380 U5 HAK	●	30,0	35,7	73,7		
	7	0380 U7 HAK	●	32,5	38,2	74,7		
3,9	3	SDP 0390 U3 HAK	●	17,9	23,7	65,7	0,7	6,0
	5	0390 U5 HAK	●	29,9	35,7	73,7		
	7	0390 U7 HAK	●	32,4	38,2	74,7		
4,0	3	SDP 0400 U3 HAK	●	17,7	23,7	65,7	0,7	6,0
	5	0400 U5 HAK	●	29,7	35,7	73,7		
	7	0400 U7 HAK	●	32,2	38,2	74,7		
4,1	3	SDP 0410 U3 HAK	●	17,6	23,7	65,7	0,7	6,0
	5	0410 U5 HAK	●	29,6	35,7	73,7		
	7	0410 U7 HAK	●	32,1	38,2	74,7		
4,2	3	SDP 0420 U3 HAK	●	17,5	23,8	65,8	0,8	6,0
	5	0420 U5 HAK	●	29,5	35,8	73,8		
	7	0420 U7 HAK	●	32,0	38,3	74,8		
4,3	3	SDP 0430 U3 HAK	●	17,4	23,8	65,8	0,8	6,0
	5	0430 U5 HAK	●	29,4	35,8	73,8		
	7	0430 U7 HAK	●	40,4	46,8	84,8		

DC	L/D	Cat. No.	Stock	LU	LCF	OAL	PL	DCON
4,4	3	SDP 0440 U3 HAK	●	17,2	23,8	65,8	0,8	6,0
	5	0440 U5 HAK	●	29,2	35,8	73,8		
	7	0440 U7 HAK	●	40,2	46,8	84,8		
4,5	3	SDP 0450 U3 HAK	●	17,1	23,8	65,8	0,8	6,0
	5	0450 U5 HAK	●	29,1	35,8	73,8		
	7	0450 U7 HAK	●	40,1	46,8	84,8		
4,6	3	SDP 0460 U3 HAK	●	16,9	23,8	65,8	0,8	6,0
	5	0460 U5 HAK	●	28,9	35,8	73,8		
	7	0460 U7 HAK	●	39,9	46,8	84,8		
4,65	3	SDP 0465 U3 HAK	●	16,8	23,8	65,8	0,8	6,0
	5	0465 U5 HAK	●	28,8	35,8	73,8		
	7	0465 U7 HAK	●	39,8	46,8	84,8		
4,7	3	SDP 0470 U3 HAK	●	16,9	23,9	65,9	0,9	6,0
	5	0470 U5 HAK	●	28,9	35,9	73,9		
	7	0470 U7 HAK	●	39,9	46,9	84,9		
4,8	3	SDP 0480 U3 HAK	●	20,7	27,9	65,9	0,9	6,0
	5	0480 U5 HAK	●	36,7	43,9	81,9		
	7	0480 U7 HAK	●	44,7	51,9	89,		
4,9	3	SDP 0490 U3 HAK	●	20,6	27,9	65,9	0,9	6,0
	5	0490 U5 HAK	●	36,6	43,9	81,9		
	7	0490 U7 HAK	●	44,6	51,9	89,9		
5,0	3	SDP 0500 U3 HAK	●	20,4	27,9	65,9	0,9	6,0
	5	0500 U5 HAK	●	36,4	43,9	81,9		
	7	0500 U7 HAK	●	44,4	51,9	89,9		
5,1	3	SDP 0510 U3 HAK	●	20,3	27,9	65,9	0,9	6,0
	5	0510 U5 HAK	●	36,3	43,9	81,9		
	7	0510 U7 HAK	●	44,3	51,9	89,9		
5,2	3	SDP 0520 U3 HAK	●	20,1	27,9	65,9	0,9	6,0
	5	0520 U5 HAK	●	36,1	43,9	81,9		
	7	0520 U7 HAK	●	44,1	51,9	89,9		
5,3	3	SDP 0530 U3 HAK	●	20,1	28,0	66,0	1,0	6,0
	5	0530 U5 HAK	●	36,1	44,0	82,0		
	7	0530 U7 HAK	●	44,1	52,0	90,0		
5,4	3	SDP 0540 U3 HAK	●	19,9	28,0	66,0	1,0	6,0
	5	0540 U5 HAK	●	35,9	44,0	82,0		
	7	0540 U7 HAK	●	50,9	59,0	97,0		
5,5	3	SDP 0550 U3 HAK	●	19,8	28,0	66,0	1,0	6,0
	5	0550 U5 HAK	●	35,8	44,0	82,0		
	7	0550 U7 HAK	●	50,8	59,0	97,0		
5,55	3	SDP 0555 U3 HAK	●	19,7	28,0	66,0	1,0	6,0
	5	0555 U5 HAK	●	35,7	44,0	82,0		
	7	0555 U7 HAK	●	50,7	59,0	97,0		
5,6	3	SDP 0560 U3 HAK	●	19,6	28,0	66,0	1,0	6,0
	5	0560 U5 HAK	●	35,6	44,0	82,0		
	7	0560 U7 HAK	●	50,6	59,0	97,0		

※ Remarks:

Non-Stock Items will be required minimum order quantity for 30 pcs.

● = Euro stock

### ■ Solid Carbide Drill with Internal Coolant Supply, Ø 5,7–8,6 mm, 3D / 5D / 7D

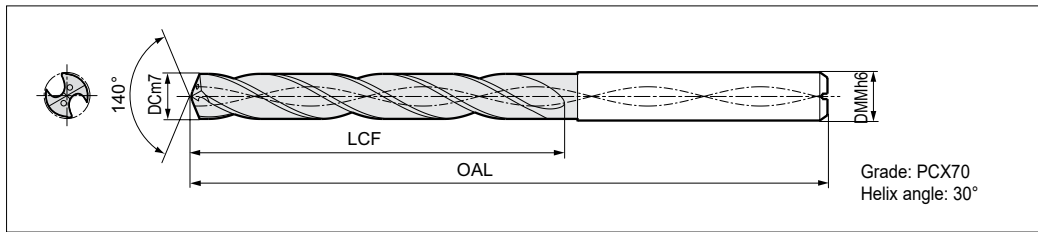

DC	L/D	Cat. No.	Stock	LU	LCF	OAL	PL	DCON
5,7	3	SDP 0570 U3 HAK	●	19,5	28,0	66,0		
	5	0570 U5 HAK	●	35,5	44,0	82,0	1,0	6,0
	7	0570 U7 HAK	●	50,5	59,0	97,0		
5,8	3	SDP 0580 U3 HAK	●	19,4	28,1	66,1		
	5	0580 U5 HAK	●	35,4	44,1	82,1	1,1	6,0
	7	0580 U7 HAK	●	50,4	59,1	97,1		
5,9	3	SDP 0590 U3 HAK	●	19,3	28,1	66,1		
	5	0590 U5 HAK	●	35,3	44,1	82,1	1,1	6,0
	7	0590 U7 HAK	●	50,3	59,1	97,1		
6,0	3	SDP 0600 U3 HAK	●	19,1	28,1	66,1		
	5	0600 U5 HAK	●	35,1	44,1	82,1	1,1	6,0
	7	0600 U7 HAK	●	50,1	59,1	97,1		
6,1	3	SDP 0610 U3 HAK	●	25,0	34,1	79,1		
	5	0610 U5 HAK	●	44,0	53,1	91,1	1,1	8,0
	7	0610 U7 HAK	●	59,0	68,1	106,1		
6,2	3	SDP 0620 U3 HAK	●	24,8	34,1	79,1		
	5	0620 U5 HAK	●	43,8	53,1	91,1	1,1	8,0
	7	0620 U7 HAK	●	58,8	68,1	106,1		
6,3	3	SDP 0630 U3 HAK	●	24,7	34,1	79,1		
	5	0630 U5 HAK	●	43,7	53,1	91,1	1,1	8,0
	7	0630 U7 HAK	●	58,7	68,1	106,1		
6,4	3	SDP 0640 U3 HAK	●	24,6	34,2	79,2		
	5	0640 U5 HAK	●	43,6	53,2	91,2	1,2	8,0
	7	0640 U7 HAK	●	58,6	68,2	106,2		
6,5	3	SDP 0650 U3 HAK	●	24,5	34,2	79,2		
	5	0650 U5 HAK	●	43,5	53,2	91,2	1,2	8,0
	7	0650 U7 HAK	●	58,5	68,2	106,2		
6,6	3	SDP 0660 U3 HAK	●	24,3	34,2	79,2		
	5	0660 U5 HAK	●	43,3	53,2	91,2	1,2	8,0
	7	0660 U7 HAK	●	58,3	68,2	106,2		
6,7	3	SDP 0670 U3 HAK	●	24,2	34,2	79,2		
	5	0670 U5 HAK	●	43,2	53,2	91,2	1,2	8,0
	7	0670 U7 HAK	●	58,2	68,2	106,2		
6,8	3	SDP 0680 U3 HAK	●	24,0	34,2	79,2		
	5	0680 U5 HAK	●	43,0	53,2	91,2	1,2	8,0
	7	0680 U7 HAK	●	58,0	68,2	106,2		
6,9	3	SDP 0690 U3 HAK	●	24,0	34,3	79,3		
	5	0690 U5 HAK	●	43,0	53,3	91,3	1,3	8,0
	7	0690 U7 HAK	●	68,0	78,3	116,3		
7,0	3	SDP 0700 U3 HAK	●	23,8	34,3	79,3		
	5	0700 U5 HAK	●	42,8	53,3	91,3	1,3	8,0
	7	0700 U7 HAK	●	67,8	78,3	116,3		
7,1	3	SDP 0710 U3 HAK	●	29,7	40,3	79,3		
	5	0710 U5 HAK	●	42,7	53,3	91,3	1,3	8,0
	7	0710 U7 HAK	●	67,7	78,3	116,3		

DC	L/D	Cat. No.	Stock	LU	LCF	OAL	PL	DCON
7,2	3	SDP 0720 U3 HAK	●	29,5	40,3	79,3		
	5	0720 U5 HAK	●	42,5	53,3	91,3	1,3	8,0
	7	0720 U7 HAK	●	67,5	78,3	116,3		
7,3	3	SDP 0730 U3 HAK	●	29,4	40,3	79,3		
	5	0730 U5 HAK	●	42,4	53,3	91,3	1,3	8,0
	7	0730 U7 HAK	●	67,4	78,3	116,3		
7,4	3	SDP 0740 U3 HAK	●	29,2	40,3	79,3		
	5	0740 U5 HAK	●	42,2	53,3	91,3	1,3	8,0
	7	0740 U7 HAK	●	67,2	78,3	116,3		
7,5	3	SDP 0750 U3 HAK	●	29,2	40,4	79,4		
	5	0750 U5 HAK	●	42,2	53,4	91,4	1,4	8,0
	7	0750 U7 HAK	●	67,2	78,4	116,4		
7,6	3	SDP 0760 U3 HAK	●	29,0	40,4	79,4		
	5	0760 U5 HAK	●	42,0	53,4	91,4	1,4	8,0
	7	0760 U7 HAK	●	67,0	78,4	116,4		
7,7	3	SDP 0770 U3 HAK	●	28,9	40,4	79,4		
	5	0770 U5 HAK	●	41,9	53,4	91,4	1,4	8,0
	7	0770 U7 HAK	●	66,9	78,4	116,4		
7,8	3	SDP 0780 U3 HAK	●	28,7	40,4	79,4		
	5	0780 U5 HAK	●	41,7	53,4	91,4	1,4	8,0
	7	0780 U7 HAK	●	66,7	78,4	116,4		
7,9	3	SDP 0790 U3 HAK	●	28,6	40,4	79,4		
	5	0790 U5 HAK	●	41,6	53,4	91,4	1,4	8,0
	7	0790 U7 HAK	●	66,6	78,4	116,4		
8,0	3	SDP 0800 U3 HAK	●	28,5	40,5	79,5		
	5	0800 U5 HAK	●	41,5	53,5	91,5	1,5	8,0
	7	0800 U7 HAK	●	66,5	78,5	116,5		
8,1	3	SDP 0810 U3 HAK	●	34,4	46,5	88,5		
	5	0810 U5 HAK	●	48,4	60,5	102,5	1,5	10,0
	7	0810 U7 HAK	●	76,4	88,5	130,5		
8,2	3	SDP 0820 U3 HAK	●	34,2	46,5	88,5		
	5	0820 U5 HAK	●	48,2	60,5	102,5	1,5	10,0
	7	0820 U7 HAK	●	76,2	88,5	130,5		
8,3	3	SDP 0830 U3 HAK	●	34,1	46,5	88,5		
	5	0830 U5 HAK	●	48,1	60,5	102,5	1,5	10,0
	7	0830 U7 HAK	●	76,1	88,5	130,5		
8,4	3	SDP 0840 U3 HAK	●	33,9	46,5	88,5		
	5	0840 U5 HAK	●	47,9	60,5	102,5	1,5	10,0
	7	0840 U7 HAK	●	75,9	88,5	130,5		
8,5	3	SDP 0850 U3 HAK	●	33,8	46,5	88,5		
	5	0850 U5 HAK	●	47,8	60,5	102,5	1,5	10,0
	7	0850 U7 HAK	●	75,8	88,5	130,5		
8,6	3	SDP 0860 U3 HAK	●	33,7	46,6	88,6		
	5	0860 U5 HAK	●	47,7	60,6	102,6	1,6	10,0
	7	0860 U7 HAK	●	75,7	88,6	130,6		

※ Remarks:

Non-Stock Items will be required minimum order quantity for 30 pcs.



# SumiDrill Power Series SDP (DIN) Type

AlCrTiN Coated Solid Carbide Drills to DIN 6537

## ■ Solid Carbide Drill with Internal Coolant Supply, Ø 8,7–11,5 mm, 3D / 5D / 7D

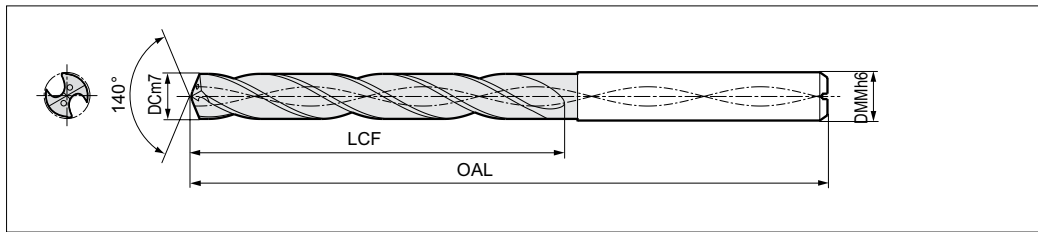

DC	L/D	Cat. No.	Stock	LU	LCF	OAL	PL	DCON
8,7	3	SDP 0870 U3 HAK	●	33,6	46,6	88,6		
	5	0870 U5 HAK	●	47,6	60,6	102,6	1,6	10,0
	7	0870 U7 HAK	●	75,6	88,6	130,6		
8,8	3	SDP 0880 U3 HAK	●	33,4	46,6	88,6		
	5	0880 U5 HAK	●	47,4	60,6	102,6	1,6	10,0
	7	0880 U7 HAK	●	75,4	88,6	130,6		
8,9	3	SDP 0890 U3 HAK	●	33,3	46,6	88,6		
	5	0890 U5 HAK	●	47,3	60,6	102,6	1,6	10,0
	7	0890 U7 HAK	●	75,3	88,6	130,6		
9,0	3	SDP 0900 U3 HAK	●	33,1	46,6	88,6		
	5	0900 U5 HAK	●	47,1	60,6	102,6	1,6	10,0
	7	0900 U7 HAK	●	75,1	88,6	130,6		
9,1	3	SDP 0910 U3 HAK	●	33,1	46,7	88,7		
	5	0910 U5 HAK	●	47,1	60,7	102,7	1,7	10,0
	7	0910 U7 HAK	●	83,1	96,7	138,7		
9,2	3	SDP 0920 U3 HAK	●	32,9	46,7	88,7		
	5	0920 U5 HAK	●	46,9	60,7	102,7	1,7	10,0
	7	0920 U7 HAK	●	82,9	96,7	138,7		
9,25	3	SDP 0925 U3 HAK	●	32,8	46,7	88,7		
	5	0925 U5 HAK	●	46,8	60,7	102,7	1,7	10,0
	7	0925 U7 HAK	●	82,8	96,7	138,7		
9,3	3	SDP 0930 U3 HAK	●	32,8	46,7	88,7		
	5	0930 U5 HAK	●	46,8	60,7	102,7	1,7	10,0
	7	0930 U7 HAK	●	82,8	96,7	138,7		
9,4	3	SDP 0940 U3 HAK	●	32,6	46,7	88,7		
	5	0940 U5 HAK	●	46,6	60,7	102,7	1,7	10,0
	7	0940 U7 HAK	●	82,6	96,7	138,7		
9,5	3	SDP 0950 U3 HAK	●	32,5	46,7	88,7		
	5	0950 U5 HAK	●	46,5	60,7	102,7	1,7	10,0
	7	0950 U7 HAK	●	82,5	96,7	138,7		
9,6	3	SDP 0960 U3 HAK	●	32,3	46,7	88,7		
	5	0960 U5 HAK	●	46,3	60,7	102,7	1,7	10,0
	7	0960 U7 HAK	●	82,3	96,7	138,7		
9,7	3	SDP 0970 U3 HAK	●	32,3	46,8	88,8		
	5	0970 U5 HAK	●	46,3	60,8	102,8	1,8	10,0
	7	0970 U7 HAK	●	82,3	96,8	138,8		
9,8	3	SDP 0980 U3 HAK	●	32,1	46,8	88,8		
	5	0980 U5 HAK	●	46,1	60,8	102,8	1,8	10,0
	7	0980 U7 HAK	●	82,1	96,8	138,8		
9,9	3	SDP 0990 U3 HAK	●	32,0	46,8	88,8		
	5	0990 U5 HAK	●	46,0	60,8	102,8	1,8	10,0
	7	0990 U7 HAK	●	82,0	96,8	138,8		
10,0	3	SDP 1000 U3 HAK	●	31,8	46,8	88,8		
	5	1000 U5 HAK	●	45,8	60,8	102,8	1,8	10,0
	7	1000 U7 HAK	●	81,8	96,8	138,8		

DC	L/D	Cat. No.	Stock	LU	LCF	OAL	PL	DCON
10,1	3	SDP 1010 U3 HAK	●	39,7	54,8	101,8		
	5	1010 U5 HAK	●	55,7	70,8	117,8	1,8	12,0
	7	1010 U7 HAK	●	92,7	107,8	154,8		
10,2	3	SDP 1020 U3 HAK	●	39,6	54,9	101,9		
	5	1020 U5 HAK	●	55,6	70,9	117,9	1,9	12,0
	7	1020 U7 HAK	●	92,6	107,9	154,9		
10,3	3	SDP 1030 U3 HAK	●	39,5	54,9	101,9		
	5	1030 U5 HAK	●	55,5	70,9	117,9	1,9	12,0
	7	1030 U7 HAK	●	92,5	107,9	154,9		
10,4	3	SDP 1040 U3 HAK	●	39,3	54,9	101,9		
	5	1040 U5 HAK	●	55,3	70,9	117,9	1,9	12,0
	7	1040 U7 HAK	●	92,3	107,9	154,9		
10,5	3	SDP 1050 U3 HAK	●	39,2	54,9	101,9		
	5	1050 U5 HAK	●	55,2	70,9	117,9	1,9	12,0
	7	1050 U7 HAK	●	92,2	107,9	154,9		
10,6	3	SDP 1060 U3 HAK	●	39,0	54,9	101,9		
	5	1060 U5 HAK	●	55,0	70,9	117,9	1,9	12,0
	7	1060 U7 HAK	●	92,0	107,9	154,9		
10,7	3	SDP 1070 U3 HAK	●	38,9	54,9	101,9		
	5	1070 U5 HAK	●	54,9	70,9	117,9	1,9	12,0
	7	1070 U7 HAK	●	91,9	107,9	154,9		
10,8	3	SDP 1080 U3 HAK	●	38,8	55,0	102,0		
	5	1080 U5 HAK	●	54,8	71,0	118,0	2,0	12,0
	7	1080 U7 HAK	●	91,8	108,0	155,0		
10,9	3	SDP 1090 U3 HAK	●	38,7	55,0	102,0		
	5	1090 U5 HAK	●	54,7	71,0	118,0	2,0	12,0
	7	1090 U7 HAK	●	91,7	108,0	155,0		
11,0	3	SDP 1100 U3 HAK	●	38,5	55,0	102,0		
	5	1100 U5 HAK	●	54,5	71,0	118,0	2,0	12,0
	7	1100 U7 HAK	●	91,5	108,0	155,0		
11,1	3	SDP 1110 U3 HAK	●	38,4	55,0	102,0		
	5	1110 U5 HAK	●	54,4	71,0	118,0	2,0	12,0
	7	1110 U7 HAK	●	99,4	116,0	163,0		
11,2	3	SDP 1120 U3 HAK	●	38,2	55,0	102,0		
	5	1120 U5 HAK	●	54,2	71,0	118,0	2,0	12,0
	7	1120 U7 HAK	●	99,2	116,0	163,0		
11,3	3	SDP 1130 U3 HAK	●	38,2	55,1	102,1		
	5	1130 U5 HAK	●	54,2	71,1	118,1	2,1	12,0
	7	1130 U7 HAK	●	99,2	116,1	163,1		
11,4	3	SDP 1140 U3 HAK	●	38,0	55,1	102,1		
	5	1140 U5 HAK	●	54,0	71,1	118,1	2,1	12,0
	7	1140 U7 HAK	●	99,0	116,1	163,1		
11,5	3	SDP 1150 U3 HAK	●	37,9	55,1	102,1		
	5	1150 U5 HAK	●	53,9	71,1	118,1	2,1	12,0
	7	1150 U7 HAK	●	98,9	116,1	163,1		

※ Remarks:

Non-Stock Items will be required minimum order quantity for 30 pcs.

● = Euro stock  
□ = Delivery on request

### ■ Solid Carbide Drill with Internal Coolant Supply, Ø 11,6–14,5 mm, 3D / 5D / 7D

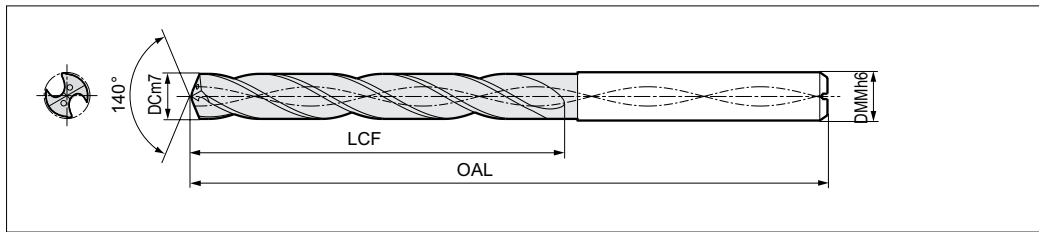

DC	L/D	Cat. No.	Stock	LU	LCF	OAL	PL	DCON
11,6	3	SDP 1160 U3 HAK	●	37,7	55,1	102,1		
	5	1160 U5 HAK	●	53,7	71,1	118,1	2,1	12,0
	7	1160 U7 HAK	●	98,7	116,1	163,1		
11,7	3	SDP 1170 U3 HAK	●	37,6	55,1	102,1		
	5	1170 U5 HAK	●	53,6	71,1	118,1	2,1	12,0
	7	1170 U7 HAK	●	98,6	116,1	163,1		
11,8	3	SDP 1180 U3 HAK	●	37,4	55,1	102,1		
	5	1180 U5 HAK	●	53,4	71,1	118,1	2,1	12,0
	7	1180 U7 HAK	●	98,4	116,1	163,1		
11,9	3	SDP 1190 U3 HAK	●	37,4	55,2	102,2		
	5	1190 U5 HAK	●	53,4	71,2	118,2	2,2	12,0
	7	1190 U7 HAK	●	98,4	116,2	163,2		
12,0	3	SDP 1200 U3 HAK	●	37,2	55,2	102,2		
	5	1200 U5 HAK	●	53,2	71,2	118,2	2,2	12,0
	7	1200 U7 HAK	●	98,2	116,2	163,2		
12,1	3	SDP 1210 U3 HAK	□	42,1	60,2	107,2		
	5	1210 U5 HAK	●	59,1	77,2	124,2	2,2	14,0
	7	1210 U7 HAK	□	117,1	135,2	182,2		
12,2	3	SDP 1220 U3 HAK	●	41,9	60,2	107,2		
	5	1220 U5 HAK	●	58,9	77,2	124,2	2,2	14,0
	7	1220 U7 HAK	●	116,9	135,2	182,2		
12,3	3	SDP 1230 U3 HAK	□	41,8	60,2	107,2		
	5	1230 U5 HAK	●	58,8	77,2	124,2	2,2	14,0
	7	1230 U7 HAK	□	116,8	135,2	182,2		
12,4	3	SDP 1240 U3 HAK	□	41,7	60,3	107,3		
	5	1240 U5 HAK	●	58,7	77,3	124,3	2,3	14,0
	7	1240 U7 HAK	□	116,7	135,3	182,3		
12,5	3	SDP 1250 U3 HAK	●	41,6	60,3	107,3		
	5	1250 U5 HAK	●	58,6	77,3	124,3	2,3	14,0
	7	1250 U7 HAK	●	116,6	135,3	182,3		
12,6	3	SDP 1260 U3 HAK	□	41,4	60,3	107,3		
	5	1260 U5 HAK	●	58,4	77,3	124,3	2,3	14,0
	7	1260 U7 HAK	□	116,4	135,3	182,3		
12,7	3	SDP 1270 U3 HAK	□	41,3	60,3	107,3		
	5	1270 U5 HAK	●	58,3	77,3	124,3	2,3	14,0
	7	1270 U7 HAK	□	116,3	135,3	182,3		
12,8	3	SDP 1280 U3 HAK	□	41,1	60,3	107,3		
	5	1280 U5 HAK	●	58,1	77,3	124,3	2,3	14,0
	7	1280 U7 HAK	□	116,3	135,3	182,3		
12,9	3	SDP 1290 U3 HAK	□	41,0	60,3	107,3		
	5	1290 U5 HAK	●	58,0	77,3	124,3	2,3	14,0
	7	1290 U7 HAK	□	116,0	135,3	182,3		
13,0	3	SDP 1300 U3 HAK	●	40,9	60,4	107,4		
	5	1300 U5 HAK	●	57,9	77,4	124,4	2,4	14,0
	7	1300 U7 HAK	●	115,9	135,4	182,4		

DC	L/D	Cat. No.	Stock	LU	LCF	OAL	PL	DCON
13,1	3	SDP 1310 U3 HAK	□	40,8	60,4	107,4		
	5	1310 U5 HAK	●	57,8	77,4	124,4	2,4	14,0
	7	1310 U7 HAK	□	115,8	135,4	182,4		
13,2	3	SDP 1320 U3 HAK	□	40,6	60,4	107,4		
	5	1320 U5 HAK	●	57,6	77,4	124,4	2,4	14,0
	7	1320 U7 HAK	□	115,6	135,4	182,4		
13,3	3	SDP 1330 U3 HAK	□	40,5	60,4	107,4		
	5	1330 U5 HAK	●	57,5	77,4	124,4	2,4	14,0
	7	1330 U7 HAK	□	115,5	135,4	182,4		
13,4	3	SDP 1340 U3 HAK	□	40,3	60,4	107,4		
	5	1340 U7 HAK	●	57,3	77,4	124,4	2,4	14,0
	7	1340 U7 HAK	□	115,3	135,4	182,4		
13,5	3	SDP 1350 U3 HAK	●	40,3	60,5	107,5		
	5	1350 U5 HAK	●	57,3	77,5	124,5	2,5	14,0
	7	1350 U7 HAK	●	115,3	135,5	182,5		
13,6	3	SDP 1360 U3 HAK	□	40,1	60,5	107,5		
	5	1360 U5 HAK	●	57,1	77,5	124,5	2,5	14,0
	7	1360 U7 HAK	□	115,1	135,5	182,5		
13,7	3	SDP 1370 U3 HAK	●	40,0	60,5	107,5		
	5	1370 U5 HAK	●	57,0	77,5	124,5	2,5	14,0
	7	1370 U7 HAK	●	115,0	135,5	182,5		
13,8	3	SDP 1380 U3 HAK	□	39,8	60,5	107,5		
	5	1380 U5 HAK	●	56,8	77,5	124,5	2,5	14,0
	7	1380 U7 HAK	□	114,8	135,5	182,5		
13,9	3	SDP 1390 U3 HAK	□	39,7	60,5	107,5		
	5	1390 U5 HAK	●	56,7	77,5	124,5	2,5	14,0
	7	1390 U7 HAK	□	114,7	135,5	182,5		
14,0	3	SDP 1400 U3 HAK	●	39,5	60,5	107,5		
	5	1400 U5 HAK	●	56,5	77,5	124,5	2,5	14,0
	7	1400 U7 HAK	●	114,5	135,5	182,5		
14,1	3	SDP 1410 U3 HAK	□	43,5	64,6	114,6		
	5	1410 U5 HAK	●	61,5	82,6	132,6	2,6	16,0
	7	1410 U7 HAK	□	132,5	153,6	203,6		
14,2	3	SDP 1420 U3 HAK	●	43,3	64,6	114,6		
	5	1420 U5 HAK	●	61,3	82,6	132,6	2,6	16,0
	7	1420 U7 HAK	●	132,3	153,6	203,6		
14,3	3	SDP 1430 U3 HAK	□	43,2	64,6	114,6		
	5	1430 U5 HAK	●	61,2	82,6	132,6	2,6	16,0
	7	1430 U7 HAK	□	132,2	153,6	203,6		
14,4	3	SDP 1440 U3 HAK	□	43,0	64,6	114,6		
	5	1440 U5 HAK	●	61,0	82,6	132,6	2,6	16,0
	7	1440 U7 HAK	□	132,0	153,6	203,6		
14,5	3	SDP 1450 U3 HAK	●	42,9	64,6	114,6		
	5	1450 U5 HAK	●	60,9	82,6	132,6	2,6	16,0
	7	1450 U7 HAK	●	131,9	153,6	203,6		

※ Remarks:

□ Non-Stock Items will be required minimum order quantity for 30 pcs.

# SumiDrill Power Series SDP (DIN) Type

AlCrTiN Coated Solid Carbide Drills to DIN 6537

## ■ Solid Carbide Drill with Internal Coolant Supply, Ø 14,6–16,0 mm, 3D / 5D / 7D

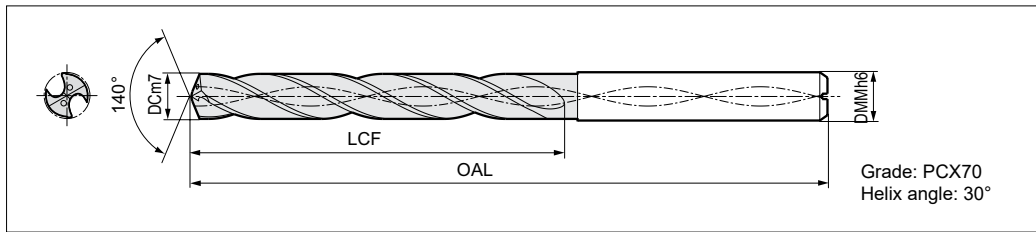

DC	L/D	Cat. No.	Stock	LU	LCF	OAL	PL	DCON
14,6	3	SDP 1460 U3 HAK	□	42,8	64,7	114,7	2,7	16,0
	5	1460 U5 HAK	●	60,8	82,7	132,7		
	7	1460 U7 HAK	□	131,8	153,7	203,7		
14,7	3	SDP 1470 U3 HAK	●	42,7	64,7	114,7	2,7	16,0
	5	1470 U5 HAK	●	60,7	82,7	132,7		
	7	1470 U7 HAK	●	131,7	153,7	203,7		
14,8	3	SDP 1480 U3 HAK	□	42,5	64,7	114,7	2,7	16,0
	5	1480 U5 HAK	●	60,5	82,7	132,7		
	7	1480 U7 HAK	□	131,5	153,7	203,7		
14,9	3	SDP 1490 U3 HAK	□	42,4	64,7	114,7	2,7	16,0
	5	1490 U5 HAK	●	60,4	82,7	132,7		
	7	1490 U7 HAK	□	131,4	153,7	203,7		
15,0	3	SDP 1500 U3 HAK	●	42,2	64,7	114,7	2,7	16,0
	5	1500 U5 HAK	●	60,2	82,7	132,7		
	7	1500 U7 HAK	●	131,2	153,7	203,7		
15,1	3	SDP 1510 U3 HAK	□	42,1	64,7	114,7	2,7	16,0
	5	1510 U5 HAK	●	60,1	82,7	132,7		
	7	1510 U7 HAK	□	131,1	153,7	203,7		
15,2	3	SDP 1520 U3 HAK	●	42,0	64,8	114,8	2,8	16,0
	5	1520 U5 HAK	●	60,0	82,8	132,8		
	7	1520 U7 HAK	●	131,0	153,8	203,8		
15,3	3	SDP 1530 U3 HAK	□	41,9	64,8	114,8	2,8	16,0
	5	1530 U5 HAK	●	59,9	82,8	132,8		
	7	1530 U7 HAK	□	130,9	153,8	203,8		
15,4	3	SDP 1540 U3 HAK	□	41,7	64,8	114,8	2,8	16,0
	5	1540 U5 HAK	●	59,7	82,8	132,8		
	7	1540 U7 HAK	□	130,7	153,8	203,8		
15,5	3	SDP 1550 U3 HAK	●	41,6	64,8	114,8	2,8	16,0
	5	1550 U5 HAK	●	59,6	82,8	132,8		
	7	1550 U7 HAK	●	130,6	153,8	203,8		
15,6	3	SDP 1560 U3 HAK	□	41,4	64,8	114,8	2,8	16,0
	5	1560 U5 HAK	●	59,4	82,8	132,8		
	7	1560 U7 HAK	□	130,4	153,8	203,8		
15,7	3	SDP 1570 U3 HAK	●	41,4	64,9	114,9	2,9	16,0
	5	1570 U5 HAK	●	59,4	82,9	132,9		
	7	1570 U7 HAK	●	130,4	153,9	203,9		
15,8	3	SDP 1580 U3 HAK	□	41,2	64,9	114,9	2,9	16,0
	5	1580 U5 HAK	●	59,2	82,9	132,9		
	7	1580 U7 HAK	□	130,2	153,9	203,9		
15,9	3	SDP 1590 U3 HAK	□	41,1	64,9	114,9	2,9	16,0
	5	1590 U5 HAK	●	59,1	82,9	132,9		
	7	1590 U7 HAK	□	130,1	153,9	203,9		
16,0	3	SDP 1600 U3 HAK	●	40,9	64,9	114,9	2,9	16,0
	5	1600 U5 HAK	●	58,9	82,9	132,9		
	7	1600 U7 HAK	●	129,9	153,9	203,9		

※ Remarks:

□ Non-Stock Items will be required minimum order quantity for 30 pcs.

● = Euro stock  
□ = Delivery on request

### Recommended Cutting Conditions

Material Group						SDP ____ U_HAK PCX70					
ISO 513	Work Material	Type/ Structure	R <sub>m</sub> N/mm <sup>2</sup>	Hardness HB30	Fitness	Ø 3,0–6,0 mm		Ø 6,1–10,0 mm		Ø 10,1–16,0 mm	
						v <sub>c</sub> =m/min	Feed rate (mm/rev)	v <sub>c</sub> =m/min	Feed rate (mm/rev)	v <sub>c</sub> =m/min	Feed rate (mm/rev)
P	Carbon steel Cast steel	free cutting steel	420	125	◎	50–80–120	0,15–0,20–0,31	70–110–140	0,20–0,25–0,42	80–120–160	0,25–0,30–0,53
		construction steel	650	190	◎	50–80–120	0,15–0,20–0,31	70–110–140	0,20–0,25–0,42	80–120–160	0,25–0,30–0,53
		case-hardened steel	850	250	◎	50–80–120	0,15–0,20–0,31	70–110–140	0,20–0,25–0,42	80–120–160	0,25–0,30–0,53
		heat-treatable steel	750	270	◎	50–80–120	0,15–0,20–0,31	70–110–140	0,20–0,25–0,42	80–120–160	0,25–0,30–0,50
		spring steel	1000	300	◎	10–20–30	0,05–0,06–0,11	15–22–30	0,08–0,09–0,14	20–28–35	0,08–0,09–0,16
	Low alloy steel Cast steel	case-hardened steel	600	180	◎	50–70–90	0,10–0,14–0,24	60–80–110	0,15–0,20–0,32	70–100–120	0,20–0,25–0,40
		heat-treatable steel	930	275	◎	45–65–85	0,10–0,14–0,24	60–80–110	0,15–0,22–0,34	65–95–120	0,20–0,25–0,37
		bearing steel	1000	300	○	40–60–80	0,10–0,15–0,26	60–80–110	0,15–0,20–0,32	60–90–120	0,20–0,25–0,37
		nitriding steel cold work steel	1200	350	◎	35–55–75	0,10–0,15–0,26	55–75–110	0,15–0,22–0,32	55–80–110	0,20–0,27–0,38
	High alloy steel	tool steel	680	200	○	30–40–50	0,10–0,15–0,25	30–40–50	0,12–0,20–0,28	30–40–50	0,12–0,20–0,32
hot work steel		1100	325	○	20–30–40	0,10–0,12–0,23	20–30–40	0,12–0,15–0,27	20–30–40	0,14–0,18–0,32	
M	Stainless steel Cast steel	martensitic/ferritic	680	200	○	40–55–70	0,08–0,10–0,21	40–60–75	0,10–0,12–0,25	50–70–80	0,10–0,12–0,25
		martensitic	820	240	◎	30–45–60	0,08–0,10–0,20	40–60–70	0,10–0,12–0,24	50–60–80	0,10–0,12–0,24
		austenitic	600	180	◎	30–45–60	0,08–0,10–0,20	40–60–70	0,10–0,12–0,24	50–60–80	0,10–0,12–0,24
		Duplex	740	230	◎	30–45–60	0,06–0,08–0,18	40–60–70	0,08–0,10–0,23	50–60–80	0,10–0,10–0,23
K	Cast iron GG	ferritic/pearlitic		180	◎	50–70–90	0,15–0,20–0,36	60–80–100	0,20–0,25–0,40	70–100–120	0,25–0,30–0,42
		pearlitic		260	◎	40–60–80	0,15–0,20–0,36	50–70–90	0,20–0,25–0,40	60–80–100	0,25–0,30–0,42
	Cast iron GGG	ferritic		160	◎	50–70–90	0,15–0,18–0,31	60–80–100	0,20–0,25–0,40	70–100–120	0,25–0,30–0,42
		pearlitic		250	◎	40–60–80	0,15–0,18–0,31	50–70–90	0,20–0,25–0,40	70–80–100	0,25–0,30–0,42
S	Heat resisting alloys	Fe-based			○	10–20–30	0,08–0,09–0,13	15–22–32	0,08–0,10–0,15	20–28–35	0,10–0,12–0,19
		Ni / Co-based			○	10–20–30	0,08–0,09–0,13	15–22–32	0,08–0,10–0,15	20–28–35	0,10–0,12–0,19
	Titanium Titanium alloys	pure Titanium	430								
		Ti-Basis			○	10–20–30	0,05–0,06–0,12	15–22–32	0,08–0,09–0,17	20–28–35	0,08–0,09–0,17
N	Aluminium Al-wrought alloys	pure aluminium									
		wrought alloys									
	Aluminium Cast alloys	Si ≤ 12%									
		Si ≥ 12%			◎	70–90–100	0,15–0,20–0,25	80–100–120	0,20–0,25–0,30	100–120–140	0,25–0,30–0,35
		Al - Mg alloys									
Zinc die-cast	Zn alloys										
Copper alloys	Copper										
	Brass			○	80–100–120	0,15–0,20–0,25	110–130–180	0,20–0,25–0,30	160–180–200	0,25–0,30–0,35	
	Bronze										
H	Hardened steel	45 HRC			○	10–20–30	0,08–0,09–0,10	15–22–32	0,08–0,10–0,12	20–28–35	0,12–0,15–0,20
		55 HRC									
		60 HRC									
		> 60 HRC									

◎ Preferred choice

○ Suitable

◎ Possible

### SDP-Identification

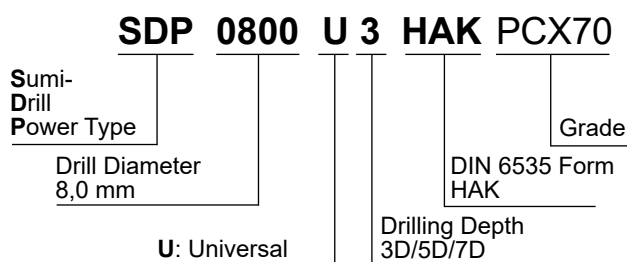

# SumiDrill Power Series SDM Type

## General Features

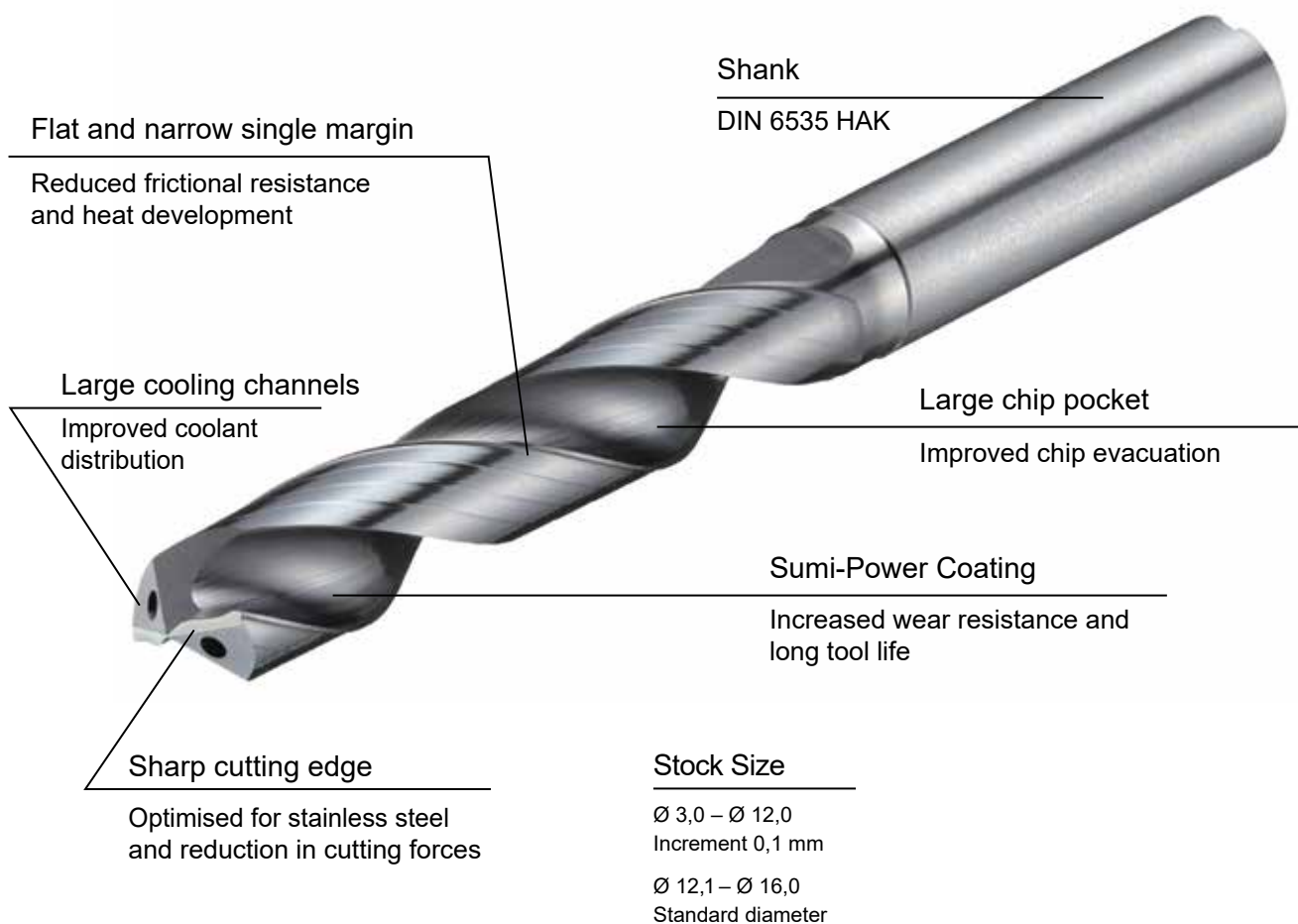

## Advantages

- High process reliability in stainless steel and low carbon steel
- Can be used on low-performance machines! (→avoids overload!)
- High surface quality in the bore
- Sharp cutting edge
- High adhesion resistance by Sumi-Power Coating

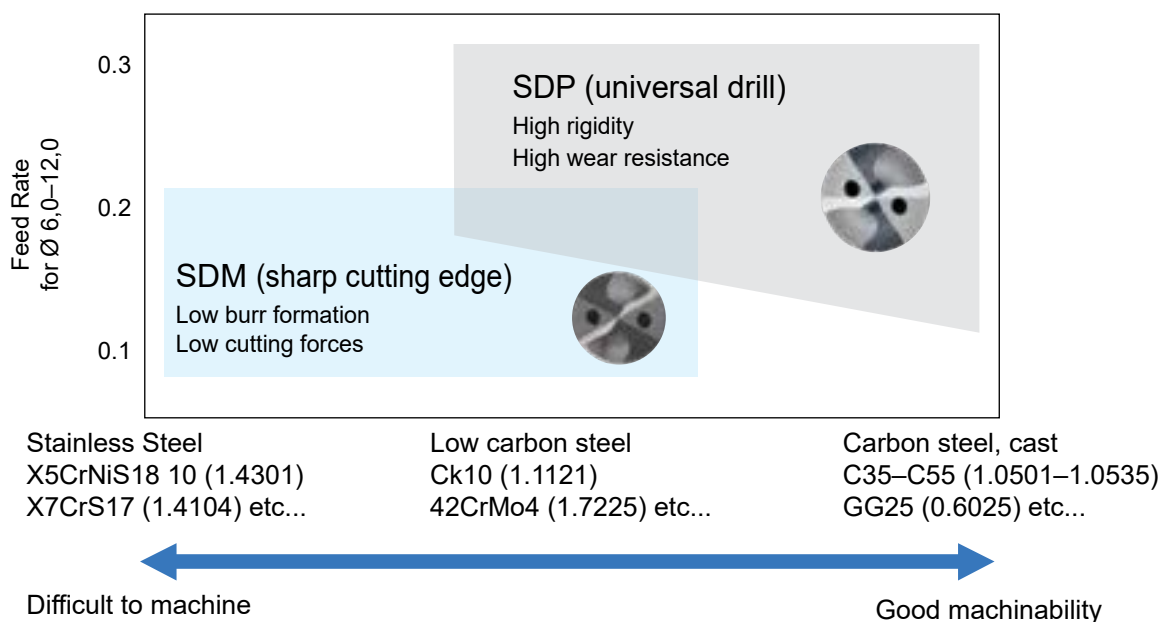

# SumiDrill Power Series SDM Type

## ■ Chip Control

Drill:	Ø 8 mm, L/D = 5
Work Material:	X5CrNiS18 10 (1.4301)
Cutting Data:	$v_c=60\text{m/min}$ , $f=0,10\text{mm/rev}$ , $a_p=19\text{mm}$ Internal coolant (2,0MPa)

### SDM



Short chips,  
good chip evacuation

### Competitor A

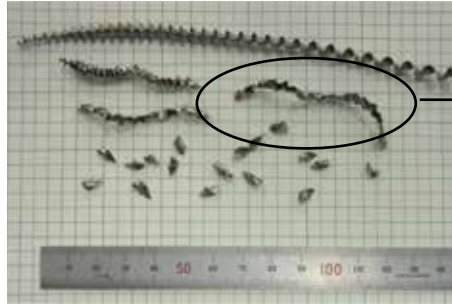

Partial long chips,  
risk of tool breakage  
by poor chip evacuation



## ■ Optimal Cutting Forces

Drill:	Ø 8 mm, L/D = 5
Work Material:	X5CrNiS18 10 (1.4301)
Cutting Data:	$v_c=60\text{m/min}$ , $f=0,20\text{mm/rev}$ , $a_p=40\text{mm}$ Internal coolant (2,0MPa)

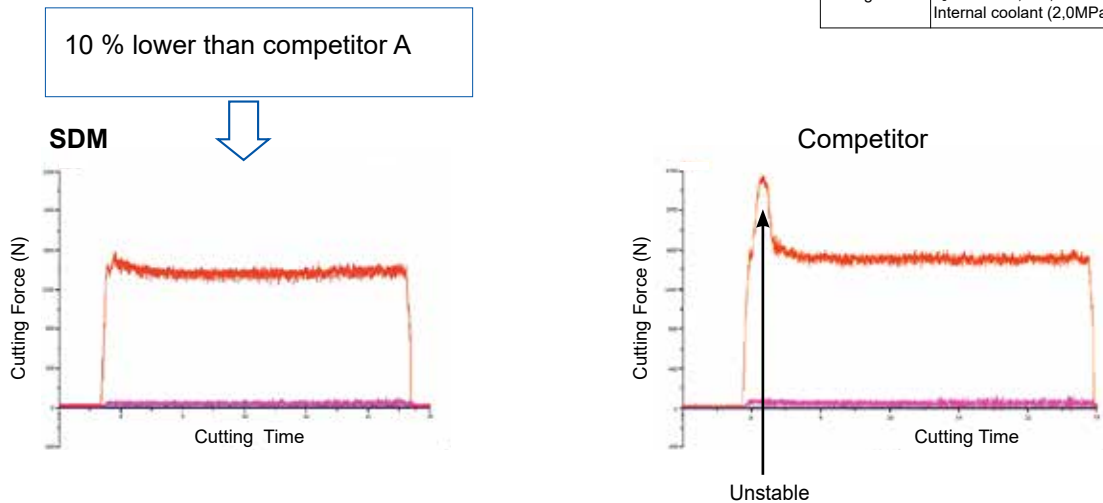

## ■ Low Burr Formation

Drill:	Ø 8 mm, L/D = 5
Work Material:	X5CrNiS18 10 (1.4301)
Cutting Data:	$v_c=60\text{m/min}$ , $f=0,20\text{mm/rev}$ , $a_p=40\text{mm}$ Internal coolant (2,0MPa)

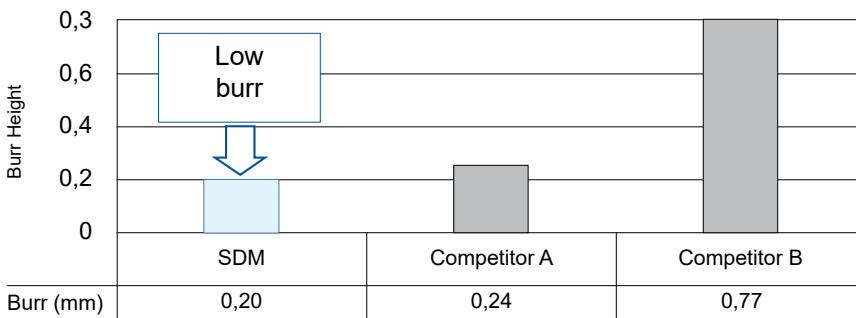



# SumiDrill Power Series

## SDM Type

### Recommended Cutting Conditions

Material Group					SDM ____ U_HAK PCX70						
ISO 513	Work Material	Type/ Structure	R <sub>m</sub> N/mm <sup>2</sup>	Hardness HB30	Fitness	Ø 3,0–6,0 mm		Ø 6,1–10,0 mm		Ø 10,1–16,0 mm	
						v <sub>c</sub> =m/min	Feed rate (mm/rev)	v <sub>c</sub> =m/min	Feed rate (mm/rev)	v <sub>c</sub> =m/min	Feed rate (mm/rev)
P	Carbon steel Cast steel	free cutting steel	420	125	○	80–100–120	0,08–0,11–0,14	80–100–120	0,10–0,15–0,20	80–100–120	0,20–0,25–0,30
		construction steel	650	190	○	80–100–120	0,08–0,11–0,14	80–100–120	0,10–0,15–0,20	80–100–120	0,20–0,25–0,30
		case-hardened steel	850	250	○	80–100–120	0,08–0,11–0,14	80–100–120	0,10–0,15–0,20	80–100–120	0,20–0,25–0,30
		heat-treatable steel	750	270	○	40–60–100	0,08–0,10–0,12	40–60–100	0,10–0,12–0,16	40–60–100	0,15–0,17–0,20
		spring steel	1000	300							
	Low alloy steel Cast steel	case-hardened steel	600	180	○	80–100–120	0,08–0,11–0,14	80–100–120	0,10–0,15–0,20	80–100–120	0,20–0,25–0,30
		heat-treatable steel	930	275	○	40–60–100	0,08–0,10–0,12	40–60–100	0,10–0,12–0,16	40–60–100	0,15–0,17–0,20
		bearing steel	1000	300							
		nitriding steel	1200	350							
	High alloy steel / Cast steel	tool steel	680	200	○	40–60–100	0,08–0,10–0,12	40–60–100	0,10–0,12–0,16	40–60–100	0,15–0,17–0,20
hot work steel		1100	325								
M	Stainless steel Cast steel	martensitic/ferritic	680	200	●	40–60–100	0,08–0,10–0,12	40–60–100	0,10–0,14–0,18	40–60–100	0,15–0,20–0,25
		martensitic/ferritic		>200	●	30–50–80	0,08–0,10–0,12	30–50–80	0,10–0,14–0,18	30–50–80	0,15–0,20–0,25
		martensitic	820	240	●	30–50–80	0,08–0,10–0,12	30–50–80	0,10–0,14–0,18	30–50–80	0,15–0,20–0,25
		austenitic	600	180	●	40–60–100	0,08–0,10–0,12	40–60–100	0,10–0,14–0,18	40–60–100	0,15–0,20–0,25
		austenitic		>200	●	30–50–80	0,08–0,10–0,12	30–50–80	0,10–0,14–0,18	30–50–80	0,15–0,20–0,25
		Duplex	740	230	●	30–45–70	0,08–0,10–0,12	30–45–70	0,10–0,14–0,18	30–45–70	0,15–0,20–0,25
		Precipitation hardened		≤450	●	30–45–70	0,08–0,10–0,12	30–45–70	0,10–0,14–0,18	30–45–70	0,15–0,20–0,25
K	Cast iron GG	ferritic/pearlitic		180							
		pearlitic		260							
	Cast iron GGG	ferritic		160							
		pearlitic		250							
S	Heat resisting alloys	Fe-based			○	20–30–40	0,06–0,08–0,10	20–30–40	0,08–0,10–0,12	20–30–40	0,10–0,12–0,15
		Ni / Co-based			○	20–30–40	0,06–0,08–0,10	20–30–40	0,08–0,10–0,12	20–30–40	0,10–0,12–0,15
	Titanium Titanium alloys	pure Titanium	430								
		Ti-Basis			○	20–30–40	0,06–0,08–0,10	20–30–40	0,08–0,10–0,12	20–30–40	0,10–0,12–0,15
N	Aluminium	pure aluminium									
		wrought alloys									
	Aluminium Cast alloys	Si ≤ 12%									
		Si ≥ 12%									
		Al - Mg alloys									
	Zinc die-cast	Zn alloys									
Copper alloys	Copper										
	Brass										
	Bronze										
H	Hardened steel	45 HRC									
		55 HRC									
		60 HRC									
		> 60 HRC									

● Preferred choice ○ Possible

### SDM-Identification

**SDM 0800 U 3 HAK PCX70**



● = Euro stock  
□ = Delivery on request

# SumiDrill Power Series SDM Type

■ Solid Carbide Drill with Internal Coolant Supply, Ø 3,0–7,5 mm, 3D / 5D

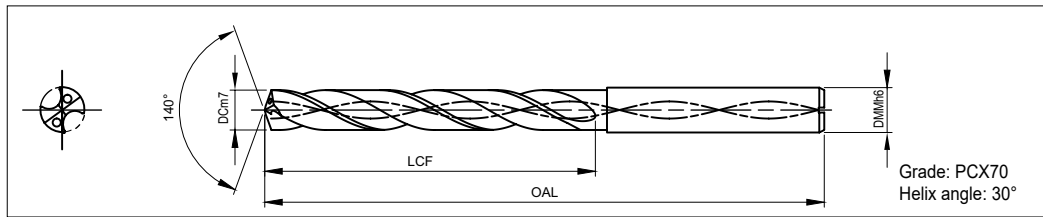

DC (mm)	DMM (mm)	Cat. No. (L/D) 3/5	3D Type			5D Type						
			Stock 3	Dimensions (mm)		Stock 5	Dimensions (mm)					
				OAL	LCF		OAL	LCF				
3,0	6	SDM 0300 U □ HAK	●	62	17	●	66	24				
3,1		SDM 0310 U □ HAK	●			●						
3,2		SDM 0320 U □ HAK	●			●						
3,25		SDM 0325 U □ HAK	□			□						
3,3		SDM 0330 U □ HAK	●			●						
3,4		SDM 0340 U □ HAK	●			●						
3,5		SDM 0350 U □ HAK	●			●						
3,6		SDM 0360 U □ HAK	●			●						
3,7		SDM 0370 U □ HAK	●			●						
3,8		SDM 0380 U □ HAK	●			66			21	●	74	33
3,9		SDM 0390 U □ HAK	●							●		
4,0		SDM 0400 U □ HAK	●							●		
4,1		SDM 0410 U □ HAK	●	●								
4,2		SDM 0420 U □ HAK	●	●								
4,3		SDM 0430 U □ HAK	●	●								
4,4		SDM 0440 U □ HAK	●	●								
4,5		SDM 0450 U □ HAK	●	●								
4,6		SDM 0460 U □ HAK	●	●								
4,65		SDM 0465 U □ HAK	□	□								
4,7		SDM 0470 U □ HAK	●	●								
4,8		SDM 0480 U □ HAK	●	25	82		●	82		41		
4,9		SDM 0490 U □ HAK	●			●						
5,0		SDM 0500 U □ HAK	●			●						
5,1		SDM 0510 U □ HAK	●			●						
5,2		SDM 0520 U □ HAK	●			●						
5,3		SDM 0530 U □ HAK	●			●						
5,4		SDM 0540 U □ HAK	●			●						
5,5		SDM 0550 U □ HAK	●			●						
5,55		SDM 0555 U □ HAK	□			□						
5,6		SDM 0560 U □ HAK	●			●						
5,7		SDM 0570 U □ HAK	●			●						
5,8		SDM 0580 U □ HAK	●			●						
5,9		SDM 0590 U □ HAK	●	79	31	●	91	50				
6,0	SDM 0600 U □ HAK	●	●									
6,1	SDM 0610 U □ HAK	●	●									
6,2	SDM 0620 U □ HAK	●	●									
6,3	SDM 0630 U □ HAK	●	●									
6,4	SDM 0640 U □ HAK	●	●									
6,5	SDM 0650 U □ HAK	●	●									
6,6	SDM 0660 U □ HAK	●	●									
6,7	SDM 0670 U □ HAK	●	●									
6,8	SDM 0680 U □ HAK	●	●									
6,9	SDM 0690 U □ HAK	●	●									
7,0	SDM 0700 U □ HAK	●	37			●			●	●	●	
7,1	SDM 0710 U □ HAK	●		●								
7,2	SDM 0720 U □ HAK	●		●								
7,3	SDM 0730 U □ HAK	●		●								
7,4	SDM 0740 U □ HAK	●		●								
7,5	SDM 0750 U □ HAK	●	●									

# SumiDrill Power Series SDM Type

## ■ Solid Carbide Drill with Internal Coolant Supply, Ø 7,6–12,0 mm, 3D / 5D

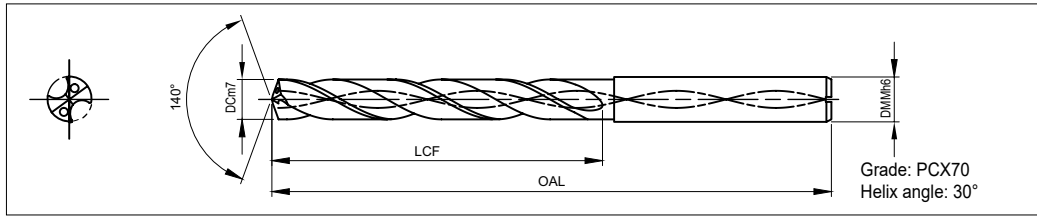

DC (mm)	DMM (mm)	Cat. No. (L/D) 3/5	3D Type			5D Type		
			Stock	Dimensions (mm)		Stock	Dimensions (mm)	
			3	OAL	LCF	5	OAL	LCF
7,6	8	SDM 0760 U □ HAK	●	79	37	●	91	50
7,7		SDM 0770 U □ HAK	●			●		
7,8		SDM 0780 U □ HAK	●			●		
7,9		SDM 0790 U □ HAK	●			●		
8,0		SDM 0800 U □ HAK	●			●		
8,1	10	SDM 0810 U □ HAK	●	89	43	●	103	57
8,2		SDM 0820 U □ HAK	●			●		
8,3		SDM 0830 U □ HAK	●			●		
8,4		SDM 0840 U □ HAK	●			●		
8,5		SDM 0850 U □ HAK	●			●		
8,6		SDM 0860 U □ HAK	●			●		
8,7		SDM 0870 U □ HAK	●			●		
8,8		SDM 0880 U □ HAK	●			●		
8,9		SDM 0890 U □ HAK	●			●		
9,0		SDM 0900 U □ HAK	●			●		
9,1		SDM 0910 U □ HAK	●			●		
9,2		SDM 0920 U □ HAK	●			●		
9,25		SDM 0925 U □ HAK	□			□		
9,3		SDM 0930 U □ HAK	●			●		
9,4		SDM 0940 U □ HAK	●			●		
9,5	SDM 0950 U □ HAK	●	●					
9,6	SDM 0960 U □ HAK	●	●					
9,7	SDM 0970 U □ HAK	●	●					
9,8	SDM 0980 U □ HAK	●	●					
9,9	SDM 0990 U □ HAK	●	●					
10,0	SDM 1000 U □ HAK	●	●					
10,1	12	SDM 1010 U □ HAK	●	102	51	●	118	67
10,2		SDM 1020 U □ HAK	●			●		
10,3		SDM 1030 U □ HAK	●			●		
10,4		SDM 1040 U □ HAK	●			●		
10,5		SDM 1050 U □ HAK	●			●		
10,6		SDM 1060 U □ HAK	●			●		
10,7		SDM 1070 U □ HAK	●			●		
10,8		SDM 1080 U □ HAK	●			●		
10,9		SDM 1090 U □ HAK	●			●		
11,0		SDM 1100 U □ HAK	●			●		
11,1		SDM 1110 U □ HAK	●			●		
11,2		SDM 1120 U □ HAK	●			●		
11,3		SDM 1130 U □ HAK	●			●		
11,4		SDM 1140 U □ HAK	●			●		
11,5		SDM 1150 U □ HAK	●			●		
11,6	SDM 1160 U □ HAK	●	●					
11,7	SDM 1170 U □ HAK	●	●					
11,8	SDM 1180 U □ HAK	●	●					
11,9	SDM 1190 U □ HAK	●	●					
12,0	SDM 1200 U □ HAK	●	●					

● = Euro stock  
□ = Delivery on request

# SumiDrill Power Series SDM Type

## ■ Solid Carbide Drill with Internal Coolant Supply, Ø 12,0–16,0 mm, 3D / 5D

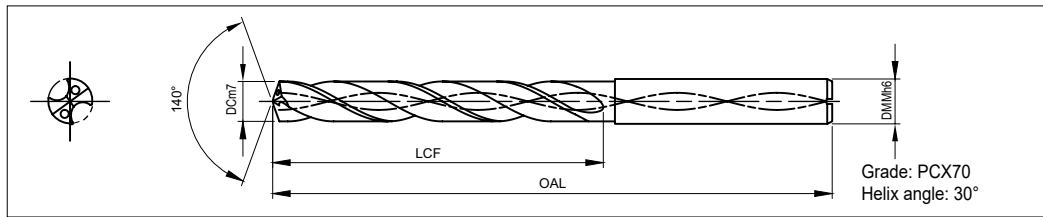

DC (mm)	DMM (mm)	Cat. No. (L/D) 3/5	3D Type		5D Type			
			Stock <b>3</b>	Dimensions (mm) OAL LCF	Stock <b>5</b>	Dimensions (mm) OAL LCF		
12,1	14	SDM 1210 U □ HAK	□	107	56	□	124	73
12,2		SDM 1220 U □ HAK	□			□		
12,3		SDM 1230 U □ HAK	□			□		
12,4		SDM 1240 U □ HAK	□			□		
12,5		SDM 1250 U □ HAK	●			●		
12,6		SDM 1260 U □ HAK	□			□		
12,7		SDM 1270 U □ HAK	□			□		
12,8		SDM 1280 U □ HAK	□			□		
12,9		SDM 1290 U □ HAK	□			□		
13,0		SDM 1300 U □ HAK	●			●		
13,1		SDM 1310 U □ HAK	□			□		
13,2		SDM 1320 U □ HAK	□			□		
13,3		SDM 1330 U □ HAK	□			□		
13,4		SDM 1340 U □ HAK	□			□		
13,5	SDM 1350 U □ HAK	●	●					
13,6	SDM 1360 U □ HAK	□	□					
13,7	SDM 1370 U □ HAK	□	□					
13,8	SDM 1380 U □ HAK	□	□					
13,9	SDM 1390 U □ HAK	□	□					
14,0	SDM 1400 U □ HAK	●	●					
14,1	16	SDM 1410 U □ HAK	□	115	60	□	133	78
14,2		SDM 1420 U □ HAK	□			□		
14,3		SDM 1430 U □ HAK	□			□		
14,4		SDM 1440 U □ HAK	□			□		
14,5		SDM 1450 U □ HAK	●			●		
14,6		SDM 1460 U □ HAK	□			□		
14,7		SDM 1470 U □ HAK	□			□		
14,8		SDM 1480 U □ HAK	□			□		
14,9		SDM 1490 U □ HAK	□			□		
15,0		SDM 1500 U □ HAK	●			●		
15,1		SDM 1510 U □ HAK	□			□		
15,2		SDM 1520 U □ HAK	□			□		
15,3		SDM 1530 U □ HAK	□			□		
15,4		SDM 1540 U □ HAK	□			□		
15,5		SDM 1550 U □ HAK	●			●		
15,6		SDM 1560 U □ HAK	□			□		
15,7	SDM 1570 U □ HAK	□	□					
15,8	SDM 1580 U □ HAK	□	□					
15,9	SDM 1590 U □ HAK	□	□					
16,0	SDM 1600 U □ HAK	●	●					

# Drill Coating

## DEX Coating



### General Features

- Sumitomo Electric Hardmetal's next-generation drill coating utilises nano-coating technology to provide more than double the tool life of conventional coatings.
- Silicon and chrome improve usure, heat, and adhesion resistance.
- New super multi-layered structure offers significantly improved chip resistance (coating strength).

### Characteristics

#### Coating Design

World's first combined super multi-layered coating is made from alternate layers of super multilayered substrates.

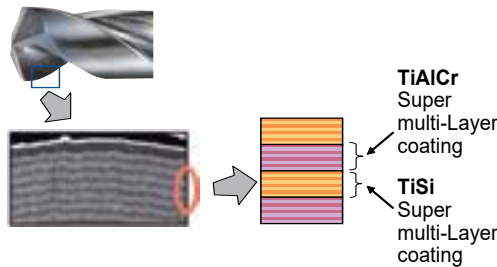

#### Characteristics of Films

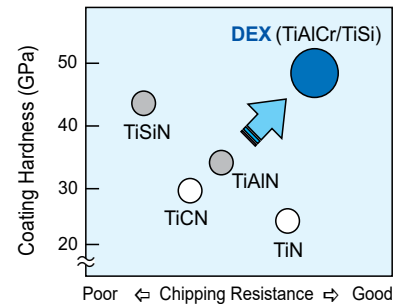

### DEX Coat Application Examples

#### MultiDrill GS Type Drilling Examples

Comparison of Usure Resistance		Comparison of Adhesion Resistance	
<p>Edge Usure Comparison for 70 m Drilling</p> <p>Shoulder and rake face feature improved usure resistance enabling long tool life.</p> <p>DEX Coating MultiDrill GS Type</p> <p>Concurrent A Drill</p>		<p>Edge Usure Comparison for 100 m Drilling</p> <p>Offers significantly improved fracture resistance to counter problems caused by shoulder and flute adhesion in soft steel drilling.</p> <p>DEX Coating MultiDrill GS Type</p> <p>Competitor B Drill</p>	
Tool:	MDW 0800 GS4	Tool:	MDW 0600 GS4
Work Material:	C50 (HB200)	Work Material:	15CrMo5 (HB120)
Cutting Conditions:	$v_c = 70$ m/min, $f = 0,25$ mm/rev, $a_p = 32$ mm External coolant (Water soluble)	Cutting Conditions:	$v_c = 60$ m/min, $f = 0,18$ mm/rev, $a_p = 18$ mm External coolant (Water soluble)

#### Long MultiDrill XHT Type Drilling Examples

<p>Reduced margin usure during deep hole MQL drilling increases number of regrinds.</p> <p>DEX Coating</p> <p>Conventional Coating</p>	
Tool:	MDW 0497 XHT20 (Ø 4,97 L/D = 29)
Work Material:	42CrMo4 (HB275) Crank Shaft
Cutting Conditions:	$v_c = 70$ m/min, $f = 0,23$ mm/rev, $a_p = 75$ mm MQL

#### MultiDrill SMD Type Drilling Examples

<p>Offers longer tool life with SEC MultiDrills as well.</p> <p>Number of holes</p> <p>DEX Coating: 1,150</p> <p>Conventional Coating: 800</p> <p>1,4x Life!</p>	
Tool:	SMDH 210 M (Ø 21,0)
Work Material:	36Mn5 (HB350) Construction Mashine Component
Cutting Conditions:	$v_c = 60$ m/min, $f = 0,25$ mm/rev, $a_p = 25$ mm Water soluble Coolant



## General Features

Super MultiDrill GS types are solid carbide drills that employ a new flute design and wide chip pocket to achieve excellent chip management and evacuation. DEX coating enables stable and long tool life over a wide range of work materials and applications.

## Characteristics and Applications

- Long tool life  
New cutting edge design and special DEX coating provide long tool life with a wide variety of work materials.
- Stable chip evacuation  
New flute shape significantly improves chip management and evacuation.
- Quiet cutting and stable cutting resistance  
Stable drilling with little wobble even in small machine applications.
- Environmentally-friendly  
Compatible with the MQL (Minimum Quantity Lubrication) system.

## Series

Coolant Supply	Type	Diameter Range (mm)	Hole Depth (L/D)
External (GS Type)	MDW □□□□ GS2	Ø 0,8 – 16,0	-2
	MDW □□□□ GS4		-4

## Performance

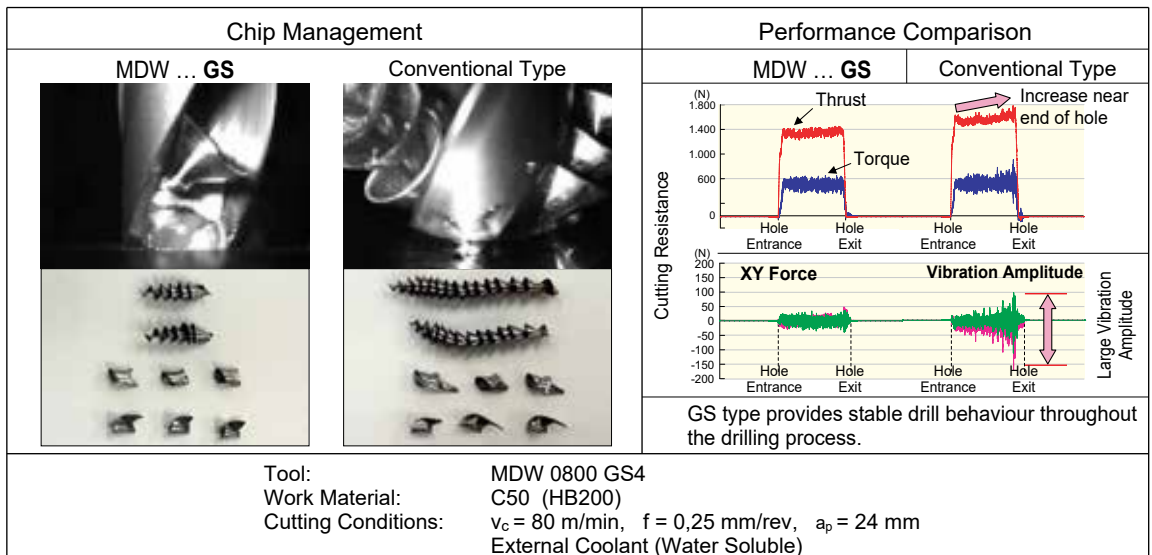

## Application Examples

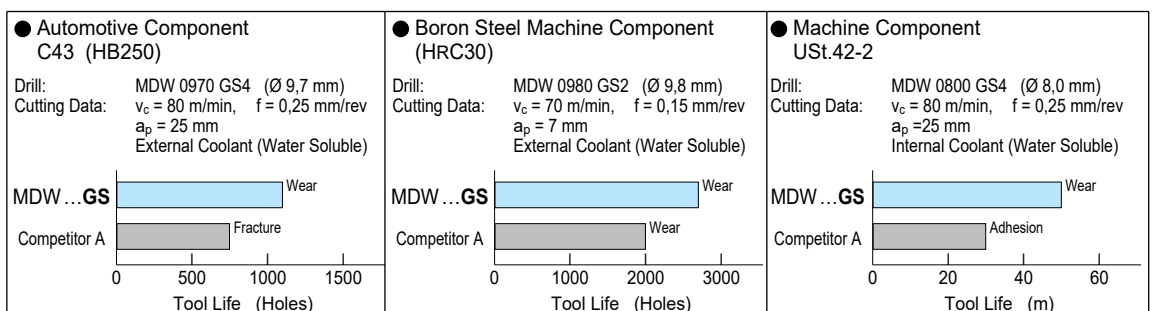



# GS Type SUPER MULTI-DRILLS

## MDW ... GS Type

Without Coolant Holes (2D/4D)

"Super Multi-Layer" DEX (TiAlCr/TiSi) Coated Solid Carbide Drills

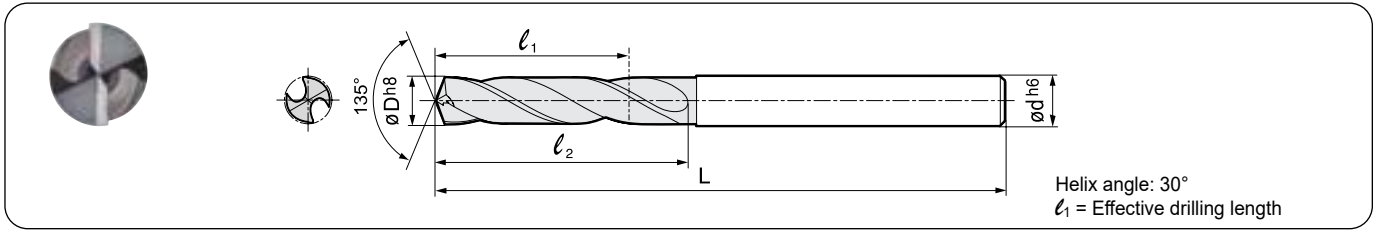

### ● Diameter Ø 2,0–6,0 mm

Dimensions		Cat. No.	Short Type (2D)				Long Type (4D)			
DC	ød		Stock	Dimensions			Stock	Dimensions		
			2	L	ℓ <sub>1</sub>	ℓ <sub>2</sub>	4	L	ℓ <sub>1</sub>	ℓ <sub>2</sub>
2,0	3,0	MDW 0200 GS□	○	45,4	6,0	8,4	○	49,4	13,0	15,4
2,1	3,0	MDW 0210 GS□	○	45,6	7,3	10,5	○	49,6	14,5	17,5
2,2		MDW 0220 GS□	○							
2,3		MDW 0230 GS□	○							
2,4		MDW 0240 GS□	○							
2,5		MDW 0250 GS□	●							
2,6		MDW 0260 GS□	●							
2,7		MDW 0270 GS□	○							
2,8		MDW 0280 GS□	●							
2,9		MDW 0290 GS□	○							
3,0		MDW 0300 GS□	○							
3,1	4,0	MDW 0310 GS□	●	54,8	15,5	19,7	○	60,8	20,5	24,7
3,2		MDW 0320 GS□	○							
3,3		MDW 0330 GS□	○							
3,4		MDW 0340 GS□	●							
3,5		MDW 0350 GS□	●							
3,6		MDW 0360 GS□	○							
3,7		MDW 0370 GS□	○							
3,8		MDW 0380 GS□	○							
3,9		MDW 0390 GS□	○							
4,0		MDW 0400 GS□	●							
4,1	5,0	MDW 0410 GS□	○	62,0	18,5	23,9	○	77,0	25,5	31,9
4,2		MDW 0420 GS□	○							
4,3		MDW 0430 GS□	○							
4,4		MDW 0440 GS□	○							
4,5		MDW 0450 GS□	○							
4,6		MDW 0460 GS□	○							
4,7		MDW 0470 GS□	○							
4,8		MDW 0480 GS□	○							
4,9		MDW 0490 GS□	○							
5,0		MDW 0500 GS□	●							
5,1	6,0	MDW 0510 GS□	○	66,2	19,5	26,1	○	82,2	33,5	40,1
5,2		MDW 0520 GS□	○							
5,3		MDW 0530 GS□	○							
5,4		MDW 0540 GS□	○							
5,5		MDW 0550 GS□	●							
5,6		MDW 0560 GS□	○							
5,7		MDW 0570 GS□	○							
5,8		MDW 0580 GS□	○							
5,9		MDW 0590 GS□	○							
6,0		MDW 0600 GS□	●							

### ● Diameter Ø 6,1–10,0 mm

Dimensions		Cat. No.	Short Type (2D)				Long Type (4D)			
DC	ød		Stock	Dimensions			Stock	Dimensions		
			2	L	ℓ <sub>1</sub>	ℓ <sub>2</sub>	4	L	ℓ <sub>1</sub>	ℓ <sub>2</sub>
6,1	7,0	MDW 0610 GS□	○	24,5	32,3	○	74,5	84,3	35,5	43,3
6,2		MDW 0620 GS□	○							
6,3		MDW 0630 GS□	○							
6,4		MDW 0640 GS□	○							
6,5		MDW 0650 GS□	●							
6,6		MDW 0660 GS□	○							
6,7		MDW 0670 GS□	○							
6,8		MDW 0680 GS□	○							
6,9		MDW 0690 GS□	○							
7,0		MDW 0700 GS□	●							
7,1	8,0	MDW 0710 GS□	○	25,6	34,6	○	79,7	91,7	37,6	46,6
7,2		MDW 0720 GS□	○							
7,3		MDW 0730 GS□	○							
7,4		MDW 0740 GS□	○							
7,5		MDW 0750 GS□	●							
7,6		MDW 0760 GS□	○							
7,7		MDW 0770 GS□	○							
7,8		MDW 0780 GS□	○							
7,9		MDW 0790 GS□	○							
8,0		MDW 0800 GS□	●							
8,1	9,0	MDW 0810 GS□	○	27,4	37,8	○	83,9	99,9	34,4	54,8
8,2		MDW 0820 GS□	○							
8,3		MDW 0830 GS□	○							
8,4		MDW 0840 GS□	○							
8,5		MDW 0850 GS□	○							
8,6		MDW 0860 GS□	○							
8,7		MDW 0870 GS□	○							
8,8		MDW 0880 GS□	○							
8,9		MDW 0890 GS□	○							
9,0		MDW 0900 GS□	○							
9,1	10,0	MDW 0910 GS□	○	28,6	40,0	○	89,0	107,0	48,6	60,0
9,2		MDW 0920 GS□	○							
9,3		MDW 0930 GS□	○							
9,4		MDW 0940 GS□	○							
9,5		MDW 0950 GS□	○							
9,6		MDW 0960 GS□	○							
9,7		MDW 0970 GS□	○							
9,8		MDW 0980 GS□	○							
9,9		MDW 0990 GS□	○							
10,0		MDW 1000 GS□	●							

### ■ Recommended Cutting Conditions for Multi-Drills GS Type

Diameter (mm)		Soft Steels (-200 HB)	General Steels (-300 HB)	Stainless Steels (-200 HB)	Grey Cast Irons	Ductile Cast Irons
-Ø 3	v <sub>c</sub>	30–50–70	30–45–60	10–30–40	40–70–90	35–55–75
	f	0,12–0,20	0,10–0,20	0,06–0,12	0,15–0,30	0,12–0,20
-Ø 5	v <sub>c</sub>	40–70–100	40–60–80	15–40–55	40–70–90	40–60–80
	f	0,15–0,25	0,15–0,25	0,08–0,15	0,15–0,30	0,15–0,25
-Ø 10	v <sub>c</sub>	50–80–130	50–70–110	15–45–60	50–80–120	50–70–100
	f	0,20–0,35	0,20–0,35	0,10–0,20	0,20–0,35	0,20–0,35
-Ø 16	v <sub>c</sub>	60–90–140	60–80–120	20–50–60	60–90–120	50–70–100
	f	0,25–0,35	0,25–0,35	0,10–0,20	0,25–0,35	0,25–0,35

(v<sub>c</sub>: Cutting Speed (m/min), f: Feed Rate (mm/rev)) (Min – Standard – Max)

● = Euro stock  
○ = Japan stock

# GS Type SUPER MULTI-DRILLS

## MDW ... GS Type

### GS Type for General Purpose Drilling of Steels

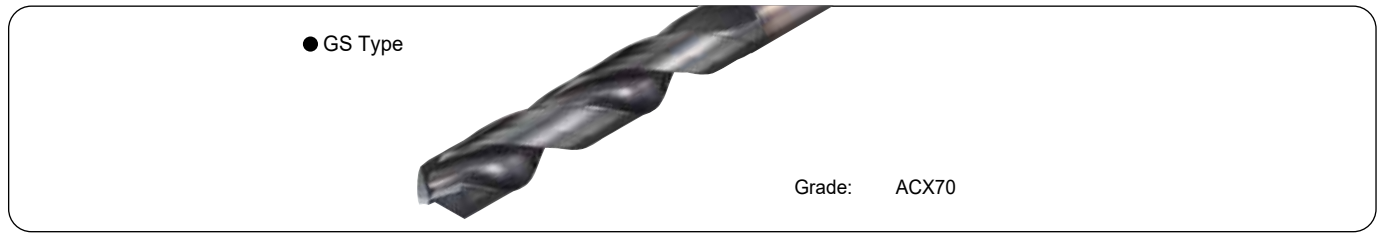

#### ● Diameter Ø 10,1–13,0 mm (mm)

Dimensions		Cat. No.	Short Type (2D)				Long Type (4D)			
DC (mm)	ød		Stock	Dimensions			Stock	Dimensions		
				2	L	ℓ <sub>1</sub>		ℓ <sub>2</sub>	4	L
10,1	11,0	MDW 1010 GS□ ○	○	95,3	30,6	43,2	○	116,2	55,6	68,2
10,2		MDW 1020 GS□ ●	○							
10,3		MDW 1030 GS□ ○	○							
10,4		MDW 1040 GS□ ○	○							
10,5		MDW 1050 GS□ ●	○							
10,6		MDW 1060 GS□ ○	○							
10,7		MDW 1070 GS□ ○	○							
10,8		MDW 1080 GS□ ○	○							
10,9		MDW 1090 GS□ ○	○							
11,0		MDW 1100 GS□ ○	○							
11,1	12,0	MDW 1110 GS□ ○	○	102,5	33,6	47,4	○	123,5	59,6	73,4
11,2		MDW 1120 GS□ ○	○							
11,3		MDW 1130 GS□ ○	○							
11,4		MDW 1140 GS□ ○	○							
11,5		MDW 1150 GS□ ○	○							
11,6		MDW 1160 GS□ ○	○							
11,7		MDW 1170 GS□ ○	○							
11,8		MDW 1180 GS□ ○	○							
11,9		MDW 1190 GS□ ○	○							
12,0		MDW 1200 GS□ ●	○							
12,1	13,0	MDW 1210 GS□ ○	○	102,7	34,6	49,6	○	139,7	63,6	78,6
12,2		MDW 1220 GS□ ○	○							
12,3		MDW 1230 GS□ ○	○							
12,4		MDW 1240 GS□ ○	○							
12,5		MDW 1250 GS□ ○	○							
12,6		MDW 1260 GS□ ○	○							
12,7		MDW 1270 GS□ ○	○							
12,8		MDW 1280 GS□ ○	○							
12,9		MDW 1290 GS□ ○	○							
13,0		MDW 1300 GS□ ○	○							

#### ● Diameter Ø 13,1–16,0 mm (mm)

Dimensions		Cat. No.	Short Type (2D)				Long Type (4D)			
DC (mm)	ød		Stock	Dimensions			Stock	Dimensions		
				2	L	ℓ <sub>1</sub>		ℓ <sub>2</sub>	4	L
13,1	14,0	MDW 1310 GS□ ○	○	107,9	36,6	52,8	○	149,9	70,2	86,8
13,2		MDW 1320 GS□ ○	○							
13,3		MDW 1330 GS□ ○	○							
13,4		MDW 1340 GS□ ○	○							
13,5		MDW 1350 GS□ ○	○							
13,6		MDW 1360 GS□ ○	○							
13,7		MDW 1370 GS□ ○	○							
13,8		MDW 1380 GS□ ○	○							
13,9		MDW 1390 GS□ ○	○							
14,0		MDW 1400 GS□ ○	○							
14,1	15,0	MDW 1410 GS□ ○	○	111,1	37,6	55,0	○	156,1	74,6	92,0
14,2		MDW 1420 GS□ ○	○							
14,3		MDW 1430 GS□ ○	○							
14,4		MDW 1440 GS□ ○	○							
14,5		MDW 1450 GS□ ○	○							
14,6		MDW 1460 GS□ ○	○							
14,7		MDW 1470 GS□ ○	○							
14,8		MDW 1480 GS□ ○	○							
14,9		MDW 1490 GS□ ○	○							
15,0		MDW 1500 GS□ ○	○							
15,1	16,0	MDW 1510 GS□ ○	○	115,5	37,6	56,2	○	169,3	78,6	97,2
15,2		MDW 1520 GS□ ○	○							
15,3		MDW 1530 GS□ ○	○							
15,4		MDW 1540 GS□ ○	○							
15,5		MDW 1550 GS□ ○	○							
15,6		MDW 1560 GS□ ○	○							
15,7		MDW 1570 GS□ ○	○							
15,8		MDW 1580 GS□ ○	○							
15,9		MDW 1590 GS□ ○	○							
16,0		MDW 1600 GS□ ○	○							

#### ■ How to Order

Non-Stock Items will be required minimum order quantity for 6 pcs.  
Please specify the Cat. No. For example, if the diameter of the drill is 10,2 mm, please indicate as follow.

E.g., **MDW 1020 GS 2/4, ACX70**  
(Grade)

SUPER MULTI-DRILLS

Drill diameter **10,2 mm**

Drilling depth (The ratio to ØD): -2 / -4

GS type MULTI-DRILLS

# Flat MultiDrill MDF Type

## Coated Carbide Drills for Spot Facing



### General Features

The flat MultiDrill MDF type is a solid carbide drill that can be used for various purposes including high-efficiency spot facing and drilling in inclined and curved surfaces.



### Advantages

- Can be used in a variety of drilling applications thanks to its point angle of 180°  
Applicable to high-efficiency spot facing, drilling in non-horizontal surfaces such as inclined and cylindrical surfaces and interrupted drilling. It also reduces burrs at hole exits.
- Improved machining stability  
Achieves high rigidity by employing RS THINNING, which ensures web thickness on the bottom face.
- Excellent chip evacuation performance  
Achieves excellent chip evacuation thanks to its wide chip pocket and high-quality rake face shape.
- Excellent cutting edge strength  
Achieves excellent cutting edge strength thanks to optimized cutting edge design.
- Expanded lineup of long type  
An expanded lineup of long type drills with diameters between  $\varnothing 3,0$  and  $\varnothing 20,0$  mm that are capable of drilling with an overhang length up to  $L/D = 10$ .
- Expanded lineup of types with oil hole  
Supports internal coolant. For deeper drilling (3D, 5D).

Improves drilling stability by ensuring web thickness.



### Reduction of Burrs at Hole Exit

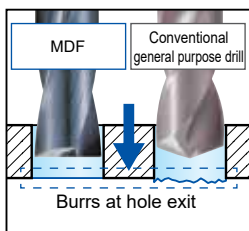

Work Material: 15CrMo5  
Drill: MDF0500S2D ( $\varnothing 5,0$  mm, 2D)  
Cutting Conditions:  $v_c = 65$  m/min,  $f = 0,12$  mm/rev  
 $H = 10$  mm, 150 holes, wet  
Equipment: Vertical machining center

Reduces exit burrs by more than half compared to general-purpose drills



Burr height: 0,18 mm  
Flat MultiDrill MDF type



Burr height: 0,44 mm  
Conventional general type

### Applications

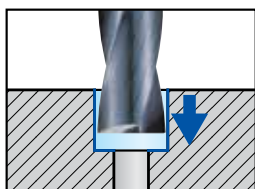

High-efficient spot facing

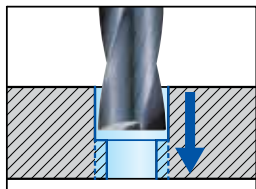

Hole expansion drilling

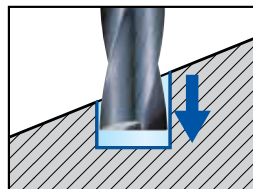

Drilling in non-horizontal surfaces (such as inclined and cylindrical)

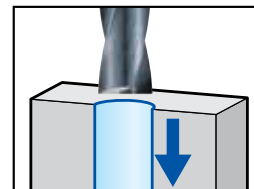

Interrupted drilling

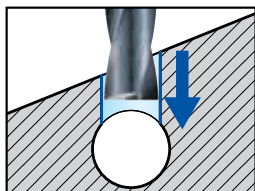

Cross drilling

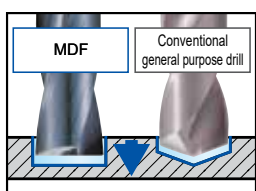

Pre-tap hole drilling in thin sheets

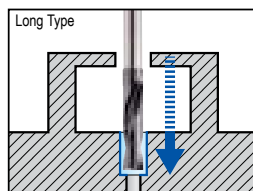

Deep spot facing

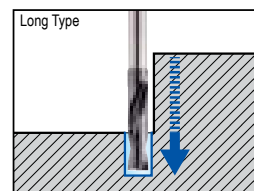

Avoiding interference with work materials

## Long Type (L2D)

For flat base drilling in long overhang conditions, hole expansion, burr prevention.  
For deep flat base drilling and to avoid interference with workpiece.  
Drilling that uses the long shank type requires a guide hole of the same diameter or a centering hole larger than the tool diameter.

- Two types    (A)  $\varnothing DC < 6 \text{ mm}$     Stepped Shank Products  
                  (B)  $\varnothing DC \geq 6 \text{ mm}$     Relief Shank Products

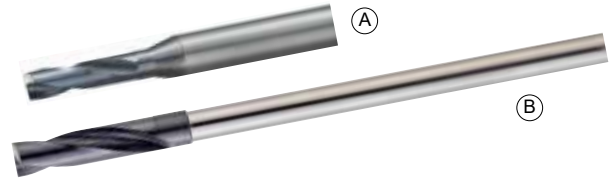

## With Oil Hole (H3D Type / H5D Type)

Support for internal coolant allows for deeper flat hole drilling.  
Drilling that uses oil hole L/D = 5 requires a guide hole of the same diameter or a centering hole larger than the tool diameter.



### Deep Spot Facing

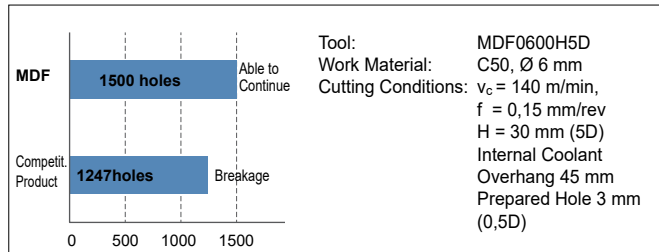

### Long Overhang Spot Facing

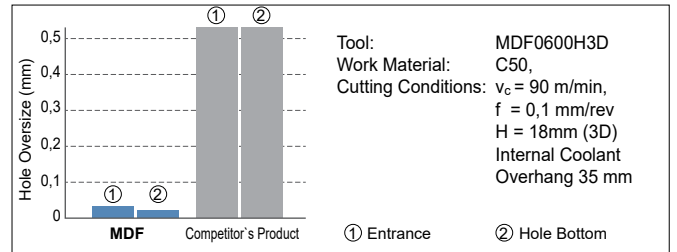

### Inclined Surface Drilling

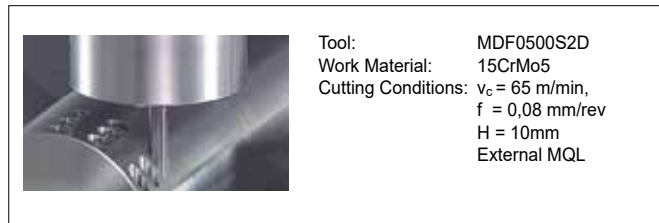

### Controlling Burrs and Chips when Withdrawn

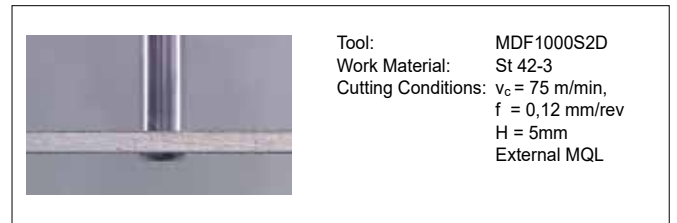

## Using Flat Drills, General-Purpose Drills and Endmills

Tool	Flat Drill MDF Type	General Purpose Drill GS/HGS Type	Endmill for Spot Facing GSX MILL Slot
Hole Bottom Shape			
Drilling in horizontal surfaces	⊙ Feed rate approximately half of a general-purpose drill	⊙ Optimal	✗ Within 1D, limited to low feed rate Feed rate one-fifth or lower of a general-purpose drill
Drilling in non-horizontal surfaces	⊙ Optimal (within 2D is recommended)	✗ Unusable	⊙ Within 1D, limited to low feed rate Feed rate half or lower of a flat drill
Traversing	✗ Unusable	✗ Unusable	⊙ Optimal

## Series

Application	Series	Diameter Range (mm)	Hole Depth (L/D)
External	MDF □□□□ S2D	$\varnothing 0,3 - 20,0$	$\leq 2,0$
	MDF □□□□ L2D	$\varnothing 0,3 - 20,0$	$\leq 2,0$
Internal	MDF □□□□ H3D	$\varnothing 0,3 - 16,0$	$\leq 3,0$
	MDF □□□□ H5D	$\varnothing 0,3 - 16,0$	$\leq 5,0$

# Flat MultiDrill MDF Type

MDF S2D Type

## External Coolant Supply (MDF S2D Type)

Carbon Steel	Alloy Steel	Tempered Steel	Hardened Steel	Stainless Steel	Cast Iron	Ductile Cast Iron	Aluminium Alloy
<0,28%	>0,28%	Steel	<45HRC	>45HRC	Steel	Cast Iron	Alloy

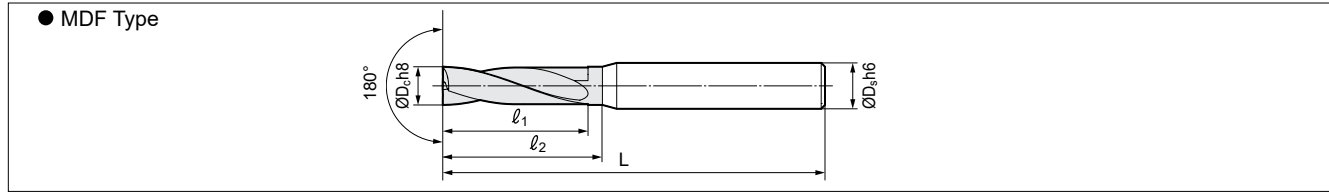

### ● Diameter Ø 0,3–7,0 mm

Diameter ØD <sub>c</sub> (mm)	Shank ØD <sub>s</sub> (mm)	Cat. No.	Stock	Dimensions (mm)		
				L	ℓ <sub>1</sub>	ℓ <sub>2</sub>
0,3*	3,0	MDF 0030S2D	○	40	1,0	1,3
0,4*		MDF 0040S2D	○		1,4	1,8
0,5	3,0	MDF 0050S2D	○	40	2,0	2,2
0,6		MDF 0060S2D	○		2,4	2,6
0,7		MDF 0070S2D	○		2,8	3,1
0,8		MDF 0080S2D	○		3,2	3,5
0,9		MDF 0090S2D	○		3,6	4,0
1,0	3,0	MDF 0100S2D	●	45	4,0	4,4
1,1		MDF 0110S2D	○		4,4	4,8
1,2		MDF 0120S2D	○		4,8	5,3
1,3		MDF 0130S2D	○		5,2	5,7
1,4		MDF 0140S2D	○		5,6	6,2
1,5	3,0	MDF 0150S2D	●	45	6,0	6,6
1,6		MDF 0160S2D	○		6,4	7,0
1,7		MDF 0170S2D	○		6,8	7,5
1,8		MDF 0180S2D	○		7,2	7,9
1,9		MDF 0190S2D	○		7,6	8,4
2,0	4,0	MDF 0200S2D	●	50	8,0	8,8
2,1		MDF 0210S2D	●		8,4	9,2
2,2		MDF 0220S2D	●		8,8	9,7
2,3		MDF 0230S2D	●		9,2	10,1
2,4		MDF 0240S2D	●		9,6	10,6
2,5	4,0	MDF 0250S2D	●	50	10,0	11,0
2,6		MDF 0260S2D	●		10,4	11,4
2,7		MDF 0270S2D	●		10,8	11,9
2,8		MDF 0280S2D	●		11,2	12,3
2,9		MDF 0290S2D	●		11,6	12,8
3,0	6,0	MDF 0300S2D	●	50	12,0	13,2
3,1		MDF 0310S2D	●		12,4	13,6
3,2		MDF 0320S2D	●		12,8	14,1
3,3		MDF 0330S2D	●		13,2	14,5
3,4		MDF 0340S2D	●		13,6	15,0
3,5	MDF 0350S2D	●	14,0	15,4		
3,6	6,0	MDF 0360S2D	●	50	14,4	15,8
3,7		MDF 0370S2D	●		14,8	16,3
3,8		MDF 0380S2D	●		15,2	16,7
3,9		MDF 0390S2D	●		15,6	17,2
4,0		MDF 0400S2D	●		16,0	17,6
4,1	6,0	MDF 0410S2D	●	60	16,4	18,0
4,2		MDF 0420S2D	●		16,8	18,5
4,3		MDF 0430S2D	●		17,2	18,9
4,4		MDF 0440S2D	●		17,6	19,4
4,5		MDF 0450S2D	●		18,0	19,8
4,6	6,0	MDF 0460S2D	●	60	18,4	20,2
4,7		MDF 0470S2D	●		18,8	20,7
4,8		MDF 0480S2D	●		19,2	21,1
4,9		MDF 0490S2D	●		19,6	21,6
5,0		MDF 0500S2D	●		20,0	22,0
5,1	6,0	MDF 0510S2D	●	60	20,4	22,4
5,2		MDF 0520S2D	●		20,8	22,9
5,3		MDF 0530S2D	●		21,2	23,3
5,4		MDF 0540S2D	●		21,6	23,8
5,5		MDF 0550S2D	●		22,0	24,2
5,6	6,0	MDF 0560S2D	●	60	22,4	24,6
5,7		MDF 0570S2D	●		22,8	25,1
5,8		MDF 0580S2D	●		23,2	25,5
5,9		MDF 0590S2D	●		23,6	26,0
6,0		MDF 0600S2D	●		24,0	26,4
6,1	8,0	MDF 0610S2D	●	70	24,4	26,8
6,2		MDF 0620S2D	●		24,8	27,3
6,3		MDF 0630S2D	●		25,2	27,7
6,4		MDF 0640S2D	●		25,6	28,2
6,5		MDF 0650S2D	●		26,0	28,6
6,6	8,0	MDF 0660S2D	●	70	26,4	29,0
6,7		MDF 0670S2D	●		26,8	29,5
6,8		MDF 0680S2D	●		27,2	29,9
6,9		MDF 0690S2D	●		27,6	30,4
7,0		MDF 0700S2D	●		28,0	30,8

### ● Diameter Ø 7,1–20,0 mm

Diameter ØD <sub>c</sub> (mm)	Shank ØD <sub>s</sub> (mm)	Cat. No.	Stock	Dimensions (mm)		
				L	ℓ <sub>1</sub>	ℓ <sub>2</sub>
7,1	8,0	MDF 0710S2D	●	70	28,4	31,2
7,2		MDF 0720S2D	●		28,8	31,7
7,3		MDF 0730S2D	●		29,2	32,1
7,4		MDF 0740S2D	●		29,6	32,6
7,5		MDF 0750S2D	●		30,0	33,0
7,6	8,0	MDF 0760S2D	●	70	30,4	33,4
7,7		MDF 0770S2D	●		30,8	33,9
7,8		MDF 0780S2D	●		31,2	34,3
7,9		MDF 0790S2D	●		31,6	34,8
8,0		MDF 0800S2D	●		32,0	35,2
8,1	10,0	MDF 0810S2D	○	80	32,4	35,6
8,2		MDF 0820S2D	○		32,8	36,1
8,3		MDF 0830S2D	○		33,2	36,5
8,4		MDF 0840S2D	○		33,6	37,0
8,5		MDF 0850S2D	●		34,0	37,4
8,6	10,0	MDF 0860S2D	○	80	34,4	37,8
8,7		MDF 0870S2D	○		34,8	38,3
8,8		MDF 0880S2D	○		35,2	38,7
8,9		MDF 0890S2D	○		35,6	39,2
9,0		MDF 0900S2D	●		36,0	39,6
9,1	10,0	MDF 0910S2D	○	80	36,4	40,0
9,2		MDF 0920S2D	○		36,8	40,5
9,3		MDF 0930S2D	○		37,2	40,9
9,4		MDF 0940S2D	○		37,6	41,4
9,5		MDF 0950S2D	●		38,0	41,8
9,6	10,0	MDF 0960S2D	○	80	38,4	42,2
9,7		MDF 0970S2D	●		38,8	42,7
9,8		MDF 0980S2D	○		39,2	43,1
9,9		MDF 0990S2D	○		39,6	43,6
10,0		MDF 1000S2D	●		40,0	44,0
10,1	12,0	MDF 1010S2D	○	90	40,4	44,4
10,2		MDF 1020S2D	○		40,8	44,9
10,3		MDF 1030S2D	○		41,2	45,3
10,4		MDF 1040S2D	○		41,6	45,8
10,5		MDF 1050S2D	●		42,0	46,2
10,6	12,0	MDF 1060S2D	○	90	42,4	46,6
10,7		MDF 1070S2D	○		42,8	47,1
10,8		MDF 1080S2D	○		43,2	47,5
10,9		MDF 1090S2D	○		43,6	48,0
11,0		MDF 1100S2D	●		44,0	48,4
11,1	12,0	MDF 1110S2D	○	90	44,4	48,8
11,2		MDF 1120S2D	○		44,8	49,3
11,3		MDF 1130S2D	○		45,2	49,7
11,4		MDF 1140S2D	○		45,6	50,2
11,5		MDF 1150S2D	●		46,0	50,6
11,6	12,0	MDF 1160S2D	○	90	46,4	51,0
11,7		MDF 1170S2D	○		46,8	51,5
11,8		MDF 1180S2D	●		47,2	51,9
11,9		MDF 1190S2D	○		47,6	52,4
12,0		MDF 1200S2D	●		48,0	52,8
12,5	14,0	MDF 1250S2D	○	100	50,0	54,0
13,0		MDF 1300S2D	○		52,0	56,8
13,5		MDF 1350S2D	○		54,0	59,6
14,0	16,0	MDF 1400S2D	○	110	56,0	62,4
14,5		MDF 1450S2D	○		58,0	65,2
15,0		MDF 1500S2D	○		60,0	68,0
15,5	16,0	MDF 1550S2D	○	115	62,0	70,8
16,0		MDF 1600S2D	○		64,0	73,6
16,5		MDF 1650S2D	○		66,0	72,4
17,0	18,0	MDF 1700S2D	○	125	68,0	75,2
17,5		MDF 1750S2D	○		70,0	78,0
18,0		MDF 1800S2D	○		72,0	80,8
18,5	20,0	MDF 1850S2D	○	140	74,0	83,6
19,0		MDF 1900S2D	○		76,0	86,4
19,5		MDF 1950S2D	○		78,0	89,2
20,0		MDF 2000S2D	○		80,0	92,0

\*RS Thinning is used for ØD<sub>c</sub> ≥ 0,5mm.

Grade: ACF75



## External Coolant Supply (L2D Type, Long Type)

Carbon Steel	Alloy Steel	Tempered Steel	Hardened Steel	Stainless Steel	Cast Iron	Ductile Cast Iron	Aluminum Alloy
<0.28%	>0.28%	Steel	<45HRC	>45HRC	Steel	Iron	Alloy

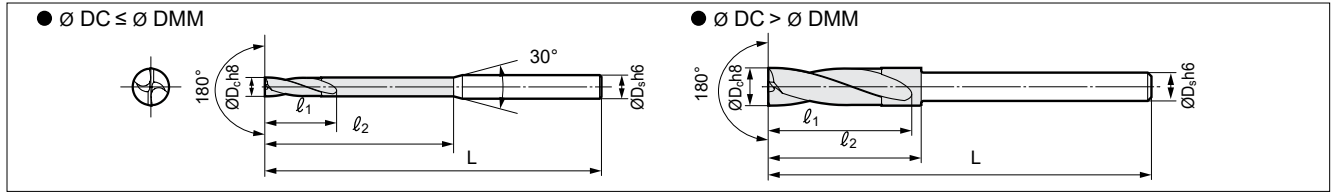

### ● Diameter $\varnothing$ 3,0–9,5 mm

Diameter $\varnothing D_c$ (mm)	Shank $\varnothing D_s$ (mm)	Cat. No.	Stock	Dimensions (mm)				
				L	$l_1$	$l_2$		
3,0	6,0	MDF 0300L2D	○	100	13,5	30,0		
3,1		0310L2D	○		14,0	31,0		
3,2		0320L2D	○		14,4	32,0		
3,3		0330L2D	○		14,9	33,0		
3,4		0340L2D	○		15,3	34,0		
3,5		0350L2D	○		15,8	35,0		
3,6	6,0	MDF 0360L2D	○	100	16,2	36,0		
3,7		0370L2D	○		16,7	37,0		
3,8		0380L2D	○		17,1	38,0		
3,9		0390L2D	○		17,6	39,0		
4,0		0400L2D	○		18,0	40,0		
4,1		6,0	MDF 0410L2D		○	100	18,5	41,0
4,2	0420L2D		○	18,9	42,0			
4,3	0430L2D		○	19,4	43,0			
4,4	0440L2D		○	19,8	44,0			
4,5	0450L2D		○	20,3	45,0			
4,6	6,0		MDF 0460L2D	○	100		20,7	46,0
4,7		0470L2D	○	21,2		47,0		
4,8		0480L2D	○	21,6		48,0		
4,9		0490L2D	○	22,1		49,0		
5,0		0500L2D	○	22,5		50,0		
5,1		6,0	MDF 0510L2D	○		110	23,0	51,0
5,2	0520L2D		○	23,4	52,0			
5,3	0530L2D		○	23,9	53,0			
5,4	0540L2D		○	24,3	54,0			
5,5	0550L2D		○	24,8	55,0			
5,6	6,0		MDF 0560L2D	○	110		25,2	56,0
5,7		0570L2D	○	25,7		57,0		
5,8		0580L2D	○	26,1		58,0		
5,9		0590L2D	○	26,6		59,0		
6,0		MDF 0600L2DS5	○	110		27,0	30,0	
6,0		MDF 0600L2D	○	110		27,0	60,0	
6,1	6,0	MDF 0610L2D	○	120	27,5	30,5		
6,2		0620L2D	○		27,9	30,9		
6,3		0630L2D	○		28,4	31,4		
6,4		0640L2D	○		28,8	31,8		
6,5		0650L2D	○		29,3	32,3		
6,6		6,0	MDF 0660L2D		○	120	29,7	32,7
6,7	0670L2D		○	30,2	33,2			
6,8	0680L2D		○	30,6	33,6			
6,9	0690L2D		○	31,1	34,1			
7,0	0700L2D		○	31,5	34,5			
7,1	6,0		MDF 0710L2D	○	130		32,0	35,0
7,2		0720L2D	○	32,4		35,4		
7,3		0730L2D	○	32,9		35,9		
7,4		0740L2D	○	33,3		36,3		
7,5		0750L2D	○	33,8		36,8		
7,6		6,0	MDF 0760L2D	○		130	34,2	37,2
7,7	0770L2D		○	34,7	37,7			
7,8	0780L2D		○	35,1	38,1			
7,9	0790L2D		○	35,6	38,6			
8,0	8,0		MDF 0800L2DS6	○	130		36,0	39,0
8,0			MDF 0800L2D	○			130	36,0
8,1		8,0	MDF 0810L2D	○		140	36,5	39,5
8,2			0820L2D	○			36,9	39,9
8,3			0830L2D	○			37,4	40,4
8,4			0840L2D	○			37,8	40,8
8,5	0850L2D		○	38,3	41,3			
8,6	8,0		MDF 0860L2D	○	140		38,7	41,7
8,7		0870L2D	○	39,2		42,2		
8,8		0880L2D	○	39,6		42,6		
8,9		0890L2D	○	40,1		43,1		
9,0		0900L2D	○	40,5		43,5		
9,1		8,0	MDF 0910L2D	○		150	41,0	44,0
9,2	0920L2D		○	41,4	44,4			
9,3	0930L2D		○	41,9	44,9			
9,4	0940L2D		○	42,3	45,3			
9,5	0950L2D		○	42,8	45,8			

### ● Diameter $\varnothing$ 9,6–20,0 mm

Diameter $\varnothing D_c$ (mm)	Shank $\varnothing D_s$ (mm)	Cat. No.	Stock	Dimensions (mm)			
				L	$l_1$	$l_2$	
9,6	8,0	MDF 0960L2D	○	150	43,2	46,2	
9,7		0970L2D	○		43,7	46,7	
9,8		0980L2D	○		44,1	47,1	
9,9		0990L2D	○		44,6	47,6	
10,0		MDF 1000L2DS8	○		150	45,0	48,0
10,0		MDF 1000L2D	○		150	45,0	100,0
10,1	10,0	MDF 1010L2D	○	160	45,5	48,5	
10,2		1020L2D	○		45,9	48,9	
10,3		1030L2D	○		46,4	49,4	
10,4		1040L2D	○		46,8	49,8	
10,5		1050L2D	○		47,3	50,3	
10,6		10,0	MDF 1060L2D		○	160	47,7
10,7	1070L2D		○	48,2	51,2		
10,8	1080L2D		○	48,6	51,6		
10,9	1090L2D		○	49,1	52,1		
11,0	1100L2D		○	49,5	52,5		
11,1	10,0		MDF 1110L2D	○	170		50,0
11,2		1120L2D	○	50,4		53,4	
11,3		1130L2D	○	50,9		53,9	
11,4		1140L2D	○	51,3		54,3	
11,5		1150L2D	○	51,8		54,8	
11,6		10,0	MDF 1160L2D	○		170	52,2
11,7	1170L2D		○	52,7	55,7		
11,8	1180L2D		○	53,1	56,1		
11,9	1190L2D		○	53,6	56,6		
12,0	MDF 1200L2DS10		○	170	54,0		57,0
12,0	MDF 1200L2D		○	170	54,0		120,0
12,5	12,0	MDF 1250L2D	○	180	56,3	59,3	
13,0		1300L2D	○		58,5	61,5	
13,5		1350L2D	○		190	60,8	63,8
14,0		MDF 1400L2DS12	○		190	63,0	66,0
14,0		MDF 1400L2D	○		190	63,0	140,0
14,5		14,0	MDF 1450L2D		○	200	65,3
15,0	1500L2D		○	67,5	70,5		
15,5	1550L2D		○	210	69,8		72,8
16,0	MDF 1600L2DS14		○	210	72,0		75,0
16,0	MDF 1600L2D		○	210	72,0		160,0
16,5	16,0		MDF 1650L2D	○	220		74,3
17,0		1700L2D	○	76,5		79,5	
17,5		1750L2D	○	230		78,8	81,8
18,0		MDF 1800L2DS16	○	230		81,0	84,0
18,0		MDF 1800L2D	○	230		81,0	180,0
18,5		18,0	MDF 1850L2D	○		240	83,3
19,0	1900L2D		○	85,5	88,5		
19,5	1950L2D		○	250	87,8		90,8
20,0	MDF 2000L2DS18		○	250	90,0		93,0
20,0	MDF 2000L2D		○	250	90,0		200,0

Grade: ACF75

Drilling that uses this tool requires a guide hole of the same diameter or a centering hole larger than the tool diameter.



### Recommended Cutting Conditions

#### ● MDF S2D Type

- The recommended hole depth is 2 x DC. The depth shall be the depth from the highest point of the hole when drilling inclined surfaces.
- The recommended cutting conditions are those for drilling in flat horizontal surfaces.
- Adjust the feed rate according to the inclination angle when drilling in an inclined surface.
  - Set the feed rate at ≤ 70% when the inclination angle is ≤ 30°
  - Set the feed rate at ≤ 50% when the inclination angle is > 30°
- This product is a drilling tool. Do not use it for traversing or helical milling

(v<sub>c</sub>: Cutting Speed m/min f: Feed Rate mm/rev)

Drill Diam. øDC (mm)	Cutting Conditions	Soft Steel / General Steel (~250 HB)	Alloy Steel (~300 HB)	Hardened Steel (~50 HRC)	Stainless Steel (~200 HB)	Gray Cast Iron FC250	Ductile Cast Iron	Aluminium Alloy
-Ø 0,5	v <sub>c</sub>	30-40-50	30-35-40	15-20-25	15-20-25	30-40-50	20-30-40	60-80-100
	f	0,004-0,005-0,006	0,004-0,005-0,006	0,001-0,002-0,003	0,003-0,004-0,005	0,004-0,005-0,006	0,001-0,003-0,005	0,003-0,005-0,007
-Ø 1,0	v <sub>c</sub>	45-55-65	35-45-55	20-30-40	20-25-30	45-55-65	30-40-50	80-100-120
	f	0,01-0,03-0,05	0,01-0,03-0,05	0,002-0,006-0,01	0,005-0,007-0,01	0,01-0,03-0,05	0,005-0,01-0,015	0,01-0,02-0,03
-Ø 2,0	v <sub>c</sub>	50-60-70	40-50-60	20-30-40	20-30-40	50-60-70	45-55-65	90-110-130
	f	0,02-0,04-0,06	0,02-0,04-0,06	0,01-0,018-0,025	0,01-0,015-0,02	0,02-0,04-0,06	0,015-0,03-0,045	0,03-0,05-0,07
-Ø 4,0	v <sub>c</sub>	60-75-90	50-65-80	20-30-40	20-30-40	60-75-90	55-65-75	90-110-130
	f	0,06-0,08-0,10	0,05-0,08-0,10	0,01-0,02-0,03	0,01-0,02-0,03	0,06-0,08-0,10	0,04-0,06-0,08	0,06-0,08-0,10
-Ø 6,0	v <sub>c</sub>	60-75-90	50-65-80	20-30-40	20-30-50	60-75-90	60-70-80	90-110-130
	f	0,05-0,10-0,15	0,05-0,10-0,15	0,04-0,06-0,08	0,03-0,04-0,05	0,05-0,10-0,15	0,06-0,09-0,12	0,05-0,10-0,15
-Ø 8,0	v <sub>c</sub>	60-75-90	50-65-80	20-30-40	20-30-50	60-75-90	60-70-80	90-110-130
	f	0,10-0,15-0,20	0,10-0,15-0,20	0,06-0,08-0,10	0,04-0,06-0,08	0,10-0,15-0,20	0,10-0,12-0,15	0,10-0,15-0,20
-Ø 10,0	v <sub>c</sub>	60-75-90	50-65-80	20-30-40	20-30-50	60-75-90	60-70-80	90-110-130
	f	0,12-0,17-0,22	0,12-0,17-0,22	0,08-0,10-0,12	0,06-0,08-0,10	0,12-0,17-0,22	0,12-0,15-0,18	0,12-0,17-0,22
-Ø 12,0	v <sub>c</sub>	60-75-90	50-65-80	20-30-40	20-30-50	60-75-90	60-70-80	90-110-130
	f	0,15-0,20-0,25	0,15-0,20-0,25	0,12-0,15-0,18	0,08-0,10-0,12	0,15-0,20-0,25	0,15-0,18-0,20	0,15-0,20-0,25
-Ø 16,0	v <sub>c</sub>	60-75-90	50-65-80	20-30-40	20-30-50	60-75-90	60-70-80	90-110-130
	f	0,20-0,25-0,30	0,20-0,25-0,30	0,14-0,17-0,20	0,10-0,15-0,20	0,17-0,22-0,27	0,15-0,20-0,25	0,20-0,25-0,30
-Ø 20,0	v <sub>c</sub>	60-75-90	50-65-80	20-30-40	20-30-50	60-75-90	60-70-80	90-110-130
	f	0,25-0,30-0,35	0,25-0,30-0,35	0,16-0,19-0,22	0,15-0,20-0,25	0,25-0,30-0,35	0,20-0,25-0,30	0,25-0,30-0,35

Min. - Optimum - Max.

#### ● MDF L2D Type, Long Type

- Drilling that uses this tool requires a guide hole of the same diameter.
- The cutting conditions are the recommended conditions with a guide hole.
- The recommended hole depth is 5 x DC. The depth is measured from the highest point of the hole on drilling in inclined surfaces.
- This product is a drilling tool. Do not use it for traversing or helical milling.

(v<sub>c</sub>: Cutting Speed m/min f: Feed Rate mm/rev)

Drill Diam. øDC (mm)	Cutting Conditions	Soft Steel / General Steel (~250 HB)	Alloy Steel (~300 HB)	Hardened Steel (~50 HRC)	Stainless Steel (~200 HB)	Gray Cast Iron FC250	Ductile Cast Iron	Aluminium Alloy
-Ø 4,0	v <sub>c</sub>	60-80-100	50-70-90	20-30-40	20-30-40	70-85-100	65-75-85	90-120-150
	f	0,06-0,08-0,10	0,05-0,08-0,10	0,01-0,02-0,03	0,01-0,02-0,03	0,06-0,08-0,10	0,04-0,06-0,08	0,06-0,08-0,10
-Ø 6,0	v <sub>c</sub>	60-80-100	50-70-90	20-30-40	20-30-50	70-85-100	65-75-85	90-120-150
	f	0,05-0,10-0,15	0,05-0,10-0,15	0,04-0,06-0,08	0,03-0,04-0,05	0,05-0,10-0,15	0,06-0,09-0,12	0,05-0,10-0,15
-Ø 8,0	v <sub>c</sub>	60-80-100	50-70-90	20-30-40	20-30-50	70-85-100	65-75-85	90-120-150
	f	0,10-0,15-0,20	0,10-0,15-0,20	0,06-0,08-0,10	0,04-0,06-0,08	0,10-0,15-0,20	0,10-0,12-0,15	0,10-0,15-0,20
-Ø 10,0	v <sub>c</sub>	60-80-100	50-70-90	20-30-40	20-30-50	70-85-100	65-75-85	90-120-150
	f	0,15-0,20-0,25	0,15-0,20-0,25	0,08-0,10-0,12	0,06-0,08-0,10	0,15-0,20-0,25	0,12-0,15-0,18	0,15-0,20-0,25
-Ø 12,0	v <sub>c</sub>	60-80-100	50-70-90	20-30-40	20-30-50	70-85-100	65-75-85	90-120-150
	f	0,20-0,25-0,30	0,20-0,25-0,30	0,12-0,15-0,18	0,08-0,10-0,12	0,17-0,22-0,27	0,15-0,20-0,25	0,20-0,25-0,30
-Ø 16,0	v <sub>c</sub>	60-80-100	50-70-90	20-30-40	20-30-50	70-85-100	65-75-85	90-120-150
	f	0,20-0,25-0,30	0,20-0,25-0,30	0,14-0,17-0,20	0,10-0,15-0,20	0,20-0,25-0,30	0,20-0,25-0,30	0,25-0,30-0,35
-Ø 20,0	v <sub>c</sub>	60-80-100	50-70-90	20-30-40	20-30-50	70-85-100	65-75-85	90-120-150
	f	0,25-0,30-0,35	0,25-0,30-0,35	0,16-0,19-0,22	0,15-0,20-0,25	0,30-0,35-0,40	0,25-0,30-0,35	0,35-0,40-0,45

Min. - Optimum - Max.

## Internal Coolant Supply (MDF H3D/H5D Type)

Carbon Steel	Alloy Steel	Tempered Steel	Hardened Steel	Stainless Steel	Cast Iron	Ductile Cast Iron	Aluminum Alloy
<0.28%	>0.28%	Steel	<45HRC	>45HRC	Steel	Cast Iron	Alloy



● MDF Type 3D Single Margin

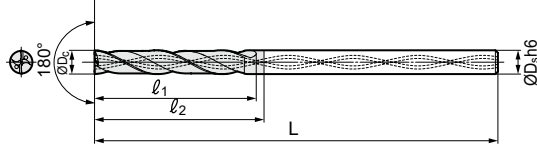

● MDF Type 5D Double Margin

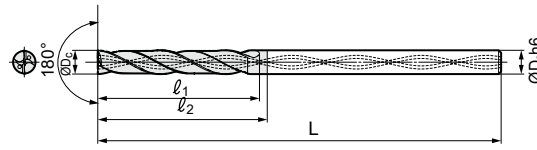

### ● Diameter Ø 3,0–6,0 mm

Diameter ØD <sub>c</sub> (mm)	Shank ØD <sub>s</sub> (mm)	Hole Depth (L/D)	Cat. No.	Stock	Dimensions (mm)		
					L	ℓ <sub>1</sub>	ℓ <sub>2</sub>
3,0	3	3	MDF 0300H3D	●	68	13,5	16,5
		5	0300H5D	●	78	20,1	23,1
3,1	4	3	MDF 0310H3D	○	72	14,0	17,0
		5	0310H5D	○	86	20,8	23,8
3,2	4	3	0320H3D	○	72	14,4	17,4
		5	0320H5D	○	86	21,4	24,4
3,3	4	3	0330H3D	○	72	14,9	17,9
		5	0330H5D	○	86	22,1	25,1
3,4	4	3	0340H3D	○	72	15,3	18,3
		5	0340H5D	○	86	22,8	25,8
3,5	4	3	0350H3D	●	72	15,8	18,8
		5	0350H5D	●	86	23,5	26,5
3,6	4	3	MDF 0360H3D	○	72	16,2	19,2
		5	0360H5D	○	86	24,1	27,1
3,7	4	3	0370H3D	○	72	16,7	19,7
		5	0370H5D	○	86	24,8	27,8
3,8	4	3	0380H3D	○	72	17,1	20,1
		5	0380H5D	○	86	25,5	28,5
3,9	4	3	0390H3D	○	72	17,6	20,6
		5	0390H5D	○	86	26,1	29,1
4,0	4	3	0400H3D	●	72	18,0	21,0
		5	0400H5D	●	86	26,8	29,8
4,1	5	3	MDF 0410H3D	○	80	18,5	21,5
		5	0410H5D	○	98	27,5	30,5
4,2	5	3	0420H3D	○	80	18,9	21,9
		5	0420H5D	○	98	28,1	31,1
4,3	5	3	0430H3D	○	80	19,4	22,4
		5	0430H5D	○	98	28,8	31,8
4,4	5	3	0440H3D	○	80	19,8	22,8
		5	0440H5D	○	98	29,5	32,5
4,5	5	3	0450H3D	●	80	20,3	23,3
		5	0450H5D	●	98	30,2	33,2
4,6	5	3	MDF 0460H3D	○	80	20,7	23,7
		5	0460H5D	○	98	30,8	33,8
4,7	5	3	0470H3D	○	80	21,2	24,2
		5	0470H5D	○	98	31,5	34,5
4,8	5	3	0480H3D	○	80	21,6	24,6
		5	0480H5D	○	98	32,2	35,2
4,9	5	3	0490H3D	○	80	22,1	25,1
		5	0490H5D	○	98	32,8	35,8
5,0	5	3	0500H3D	●	80	22,5	25,5
		5	0500H5D	●	98	33,5	36,5
5,1	6	3	MDF 0510H3D	○	82	23,0	26,0
		5	0510H5D	○	100	34,2	37,2
5,2	6	3	0520H3D	○	82	23,4	26,4
		5	0520H5D	○	100	34,8	37,8
5,3	6	3	0530H3D	○	82	23,9	26,9
		5	0530H5D	○	100	35,5	38,5
5,4	6	3	0540H3D	○	82	24,3	27,3
		5	0540H5D	○	100	36,2	39,2
5,5	6	3	0550H3D	●	82	24,8	27,8
		5	0550H5D	●	100	36,9	39,9
5,6	6	3	MDF 0560H3D	○	82	25,2	28,2
		5	0560H5D	○	100	37,5	40,5
5,7	6	3	0570H3D	○	82	25,7	28,7
		5	0570H5D	○	100	38,2	41,2
5,8	6	3	0580H3D	○	82	26,1	29,1
		5	0580H5D	○	100	38,9	41,9
5,9	6	3	0590H3D	○	82	26,6	29,6
		5	0590H5D	○	100	39,5	42,5
6,0	6	3	0600H3D	●	82	27,0	30,0
		5	0600H5D	●	100	40,2	43,2

### ● Diameter Ø 6,1–9,0 mm

Diameter ØD <sub>c</sub> (mm)	Shank ØD <sub>s</sub> (mm)	Hole Depth (L/D)	Cat. No.	Stock	Dimensions (mm)		
					L	ℓ <sub>1</sub>	ℓ <sub>2</sub>
6,1	7	3	MDF 0610H3D	○	88	27,5	30,5
		5	0610H5D	○	109	40,9	43,9
6,2	7	3	0620H3D	○	88	27,9	30,9
		5	0620H5D	○	109	41,5	44,5
6,3	7	3	0630H3D	○	88	28,4	31,4
		5	0630H5D	○	109	42,2	45,2
6,4	7	3	0640H3D	○	88	28,8	31,8
		5	0640H5D	○	109	42,9	45,9
6,5	7	3	0650H3D	●	88	29,3	32,3
		5	0650H5D	●	109	43,6	46,6
6,6	7	3	MDF 0660H3D	○	88	29,7	32,7
		5	0660H5D	○	109	44,2	47,2
6,7	7	3	0670H3D	○	88	30,2	33,2
		5	0670H5D	○	109	44,9	47,9
6,8	7	3	0680H3D	○	88	30,6	33,6
		5	0680H5D	○	109	45,6	48,6
6,9	7	3	0690H3D	○	88	31,1	34,1
		5	0690H5D	○	109	46,2	49,2
7,0	7	3	0700H3D	●	88	31,5	34,5
		5	0700H5D	●	109	46,9	49,9
7,1	8	3	MDF 0710H3D	○	94	32,0	35,0
		5	0710H5D	○	118	47,6	50,6
7,2	8	3	0720H3D	○	94	32,4	35,4
		5	0720H5D	○	118	48,2	51,2
7,3	8	3	0730H3D	○	94	32,9	35,9
		5	0730H5D	○	118	48,9	51,9
7,4	8	3	0740H3D	○	94	33,3	36,3
		5	0740H5D	○	118	49,6	52,6
7,5	8	3	0750H3D	●	94	33,8	36,8
		5	0750H5D	●	118	50,3	53,3
7,6	8	3	MDF 0760H3D	○	94	34,2	37,2
		5	0760H5D	○	118	50,9	53,9
7,7	8	3	0770H3D	○	94	34,7	37,7
		5	0770H5D	○	118	51,6	54,6
7,8	8	3	0780H3D	○	94	35,1	38,1
		5	0780H5D	○	118	52,3	55,3
7,9	8	3	0790H3D	○	94	35,6	38,6
		5	0790H5D	○	118	52,9	55,9
8,0	8	3	0800H3D	●	94	36,0	39,0
		5	0800H5D	●	118	53,6	56,6
8,1	9	3	MDF 0810H3D	○	100	36,5	39,5
		5	0810H5D	○	127	54,3	57,3
8,2	9	3	0820H3D	○	100	36,9	39,9
		5	0820H5D	○	127	54,9	57,9
8,3	9	3	0830H3D	○	100	37,4	40,4
		5	0830H5D	○	127	55,6	58,6
8,4	9	3	0840H3D	○	100	37,8	40,8
		5	0840H5D	○	127	56,3	59,3
8,5	9	3	0850H3D	●	100	38,3	41,3
		5	0850H5D	●	127	57,0	60,0
8,6	9	3	MDF 0860H3D	○	100	38,7	41,7
		5	0860H5D	○	127	57,6	60,6
8,7	9	3	0870H3D	○	100	39,2	42,2
		5	0870H5D	○	127	58,3	61,3
8,8	9	3	0880H3D	○	100	39,6	42,6
		5	0880H5D	○	127	59,0	62,0
8,9	9	3	0890H3D	○	100	40,1	43,1
		5	0890H5D	○	127	59,6	62,6
9,0	9	3	0900H3D	●	100	40,5	43,5
		5	0900H5D	●	127	60,3	63,3

Grade: ACF75

# Flat MultiDrill MDF Type

MDF Type with Oil Hole - H3D / H5D

## Internal Coolant Supply (MDF H3D/H5D Type)

Carbon Steel	Alloy Steel	Tempered Steel	Hardened Steel	Stainless Steel	Cast Iron	Ductile Cast Iron	Aluminium Alloy
<0,28%	>0,28%	<45HRC	>45HRC	Steel	Iron	Cast Iron	Alloy



### MDF Type 3D Single Margin

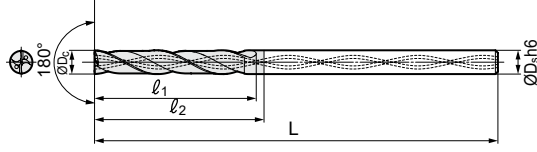

### MDF Type 5D Double Margin

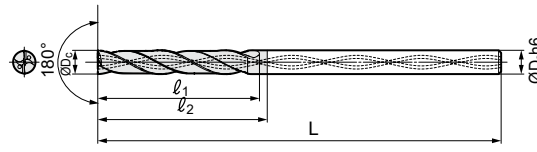

### ● Diameter Ø 9,1–12,0 mm

Diameter ØDc (mm)	Shank ØDs (mm)	Hole Depth (L/D)	Cat. No.	Stock	Dimensions (mm)		
					L	l <sub>1</sub>	l <sub>2</sub>
9,1	10	3	MDF 0910H3D	○	106	41,0	44,0
		5	0910H5D	○	136	61,0	64,0
9,2	10	3	0920H3D	○	106	41,4	44,4
		5	0920H5D	○	136	61,6	64,6
9,3	10	3	0930H3D	○	106	41,9	44,9
		5	0930H5D	○	136	62,3	65,3
9,4	10	3	0940H3D	○	106	42,3	45,3
		5	0940H5D	○	136	63,0	66,0
9,5	10	3	0950H3D	●	106	42,8	45,8
		5	0950H5D	●	136	63,7	66,7
9,6	10	3	MDF 0960H3D	○	106	43,2	46,2
		5	0960H5D	○	136	64,3	67,3
9,7	10	3	0970H3D	○	106	43,7	46,7
		5	0970H5D	○	136	65,0	68,0
9,8	10	3	0980H3D	○	106	44,1	47,1
		5	0980H5D	○	136	65,7	68,7
9,9	10	3	0990H3D	○	106	44,6	47,6
		5	0990H5D	○	136	66,3	69,3
10,0	10	3	1000H3D	●	106	45,0	48,0
		5	1000H5D	●	136	67,0	70,0
10,1	11	3	MDF 1010H3D	○	116	45,5	48,5
		5	1010H5D	○	149	67,7	70,7
10,2	11	3	1020H3D	○	116	45,9	48,9
		5	1020H5D	○	149	68,3	71,3
10,3	11	3	1030H3D	○	116	46,4	49,4
		5	1030H5D	○	149	69,0	72,0
10,4	11	3	1040H3D	○	116	46,8	49,8
		5	1040H5D	○	149	69,7	72,7
10,5	11	3	1050H3D	●	116	47,3	50,3
		5	1050H5D	●	149	70,4	73,4
10,6	11	3	MDF 1060H3D	○	116	47,7	50,7
		5	1060H5D	○	149	71,0	74,0
10,7	11	3	1070H3D	○	116	48,2	51,2
		5	1070H5D	○	149	71,7	74,7
10,8	11	3	1080H3D	○	116	48,6	51,6
		5	1080H5D	○	149	72,4	75,4
10,9	11	3	1090H3D	○	116	49,1	52,1
		5	1090H5D	○	149	73,0	76,0
11,0	11	3	1100H3D	●	116	49,5	52,5
		5	1100H5D	●	149	73,7	76,7
11,1	12	3	MDF 1110H3D	○	122	50,0	53,0
		5	1110H5D	○	158	74,4	77,4
11,2	12	3	1120H3D	○	122	50,4	53,4
		5	1120H5D	○	158	75,0	78,0
11,3	12	3	1130H3D	○	122	50,9	53,9
		5	1130H5D	○	158	75,7	78,7
11,4	12	3	1140H3D	○	122	51,3	54,3
		5	1140H5D	○	158	76,4	79,4
11,5	12	3	1150H3D	●	122	51,8	54,8
		5	1150H5D	●	158	77,1	80,1
11,6	12	3	MDF 1160H3D	○	122	52,2	55,2
		5	1160H5D	○	158	77,7	80,7
11,7	12	3	1170H3D	○	122	52,7	55,7
		5	1170H5D	○	158	78,4	81,4
11,8	12	3	1180H3D	○	122	53,1	56,1
		5	1180H5D	○	158	79,1	82,1
11,9	12	3	1190H3D	○	122	53,6	56,6
		5	1190H5D	○	158	79,7	82,7
12,0	12	3	1200H3D	●	122	54,0	57,0
		5	1200H5D	●	158	80,4	83,4

### ● Diameter Ø 12,5–16,0 mm

Diameter ØDc (mm)	Shank ØDs (mm)	Hole Depth (L/D)	Cat. No.	Stock	Dimensions (mm)		
					L	l <sub>1</sub>	l <sub>2</sub>
12,5	13	3	MDF 1250H3D	○	128	56,3	59,3
		5	1250H5D	○	167	83,8	86,8
13,0	13	3	1300H3D	○	128	58,5	61,5
		5	1300H5D	○	167	87,1	90,1
13,5	14	3	MDF 1350H3D	○	134	60,8	63,8
		5	1350H5D	○	176	90,5	93,5
14,0	14	3	1400H3D	○	134	63,0	66,0
		5	1400H5D	○	176	93,8	96,8
14,5	15	3	MDF 1450H3D	○	140	65,3	68,3
		5	1450H5D	○	185	97,2	100,2
15,0	15	3	1500H3D	○	140	67,5	70,5
		5	1500H5D	○	185	100,5	103,5
15,5	16	3	MDF 1550H3D	○	146	69,8	72,8
		5	1550H5D	○	194	103,9	106,9
16,0	16	3	1600H3D	○	146	72,0	75,0
		5	1600H5D	○	194	107,2	110,2

Grade: ACF75

● = Euro stock  
○ = Japan stock

### Recommended Cutting Conditions

#### ● MDF H3D Type with Oil Hole

- The recommended hole depth is 3 x DC. The depth is measured from the highest point of the hole on drilling in inclined surfaces.
- The recommended cutting conditions are those for drilling on flat horizontal surfaces.
- Adjust the feed rate according to the inclination angle when drilling in an inclined surface.
  - Set the feed rate at  $\leq 70\%$  when the inclination angle is  $\leq 30^\circ$ .
  - Set the feed rate at  $\leq 50\%$  when the inclination angle is  $> 30^\circ$ .
- This product is a drilling tool. Do not use it for traversing or helical milling.
- A guide hole of the same diameter is recommended when drilling stainless steel.

(vc: Cutting Speed m/min f: Feed Rate mm/rev)

Drill Diam. ØDC(mm)	Cutting Conditions	Soft Steel / General Steel (-250 HB)	Alloy Steel (-300 HB)	Hardened Steel (-50 HRC)	Stainless Steel (-200 HB)	Gray Cast Iron FC250	Ductile Cast Iron	Aluminium Alloy
-Ø 4,0	vc	70-85-100	60-75-90	30-40-50	25-35-45	70-85-100	65-75-85	90-120-150
	f	0,06-0,08-0,10	0,05-0,08-0,10	0,01-0,02-0,03	0,01-0,02-0,03	0,06-0,08-0,10	0,04-0,06-0,08	0,06-0,08-0,10
-Ø 6,0	vc	70-85-100	60-75-90	30-40-50	25-35-45	70-85-100	70-80-90	90-120-150
	f	0,05-0,10-0,15	0,05-0,10-0,15	0,04-0,06-0,08	0,03-0,04-0,05	0,05-0,10-0,15	0,06-0,09-0,12	0,05-0,10-0,15
-Ø 8,0	vc	70-85-100	60-75-90	30-40-50	25-35-45	70-85-100	70-80-90	90-120-150
	f	0,10-0,15-0,20	0,10-0,15-0,20	0,06-0,08-0,10	0,04-0,06-0,08	0,10-0,15-0,20	0,10-0,12-0,15	0,10-0,15-0,20
-Ø 10,0	vc	70-85-100	60-75-90	30-40-50	25-35-45	70-85-100	70-80-90	90-120-150
	f	0,12-0,17-0,22	0,12-0,17-0,22	0,08-0,10-0,12	0,06-0,08-0,10	0,12-0,17-0,22	0,12-0,15-0,18	0,15-0,20-0,25
-Ø 12,0	vc	70-85-100	60-75-90	30-40-50	25-35-45	70-85-100	70-80-90	90-120-150
	f	0,15-0,20-0,25	0,15-0,20-0,25	0,12-0,15-0,18	0,08-0,10-0,12	0,15-0,20-0,25	0,15-0,18-0,20	0,20-0,25-0,30
-Ø 16,0	vc	70-85-100	60-75-90	30-40-50	25-35-45	70-85-100	70-80-90	90-120-150
	f	0,15-0,20-0,25	0,15-0,20-0,25	0,12-0,15-0,18	0,10-0,15-0,20	0,17-0,22-0,27	0,15-0,20-0,25	0,25-0,30-0,40

Min. - Optimum - Max.

#### ● MDF H5D Type with Oil Hole

- Drilling that uses this tool requires a guide hole of the same diameter.
- The cutting conditions are the recommended conditions with a guide hole.
- The recommended hole depth is 5 x DC. The depth is measured from the highest point of the hole on drilling in inclined surfaces.
- This product is a drilling tool. Do not use it for traversing or helical milling.

(vc: Cutting Speed m/min f: Feed Rate mm/rev)

Drill Diam. ØDC(mm)	Cutting Conditions	Soft Steel / General Steel (-250 HB)	Alloy Steel (-300 HB)	Hardened Steel (-50 HRC)	Stainless Steel (-200 HB)	Gray Cast Iron FC250	Ductile Cast Iron	Aluminium Alloy
-Ø 4,0	vc	70-85-100	60-75-90	30-40-50	25-35-45	70-85-100	65-75-85	90-120-150
	f	0,06-0,08-0,10	0,05-0,08-0,10	0,01-0,02-0,03	0,01-0,02-0,03	0,06-0,08-0,10	0,04-0,06-0,08	0,06-0,08-0,10
-Ø 6,0	vc	70-85-100	60-75-90	30-40-50	25-35-45	70-85-100	65-75-85	90-120-150
	f	0,05-0,10-0,15	0,05-0,10-0,15	0,04-0,06-0,08	0,03-0,04-0,05	0,05-0,10-0,15	0,06-0,09-0,12	0,05-0,10-0,15
-Ø 8,0	vc	70-85-100	60-75-90	30-40-50	25-35-45	70-85-100	65-75-85	90-120-150
	f	0,10-0,15-0,20	0,10-0,15-0,20	0,06-0,08-0,10	0,04-0,06-0,08	0,10-0,15-0,20	0,10-0,12-0,15	0,10-0,15-0,20
-Ø 10,0	vc	70-85-100	60-75-90	30-40-50	25-35-45	70-85-100	65-75-85	90-120-150
	f	0,15-0,20-0,25	0,15-0,20-0,25	0,08-0,10-0,12	0,06-0,08-0,10	0,15-0,20-0,25	0,12-0,15-0,18	0,15-0,20-0,25
-Ø 12,0	vc	70-85-100	60-75-90	30-40-50	25-35-45	70-85-100	65-75-85	90-120-150
	f	0,20-0,25-0,30	0,20-0,25-0,30	0,12-0,15-0,18	0,08-0,10-0,12	0,17-0,22-0,27	0,15-0,20-0,25	0,20-0,25-0,30
-Ø 16,0	vc	70-85-100	60-75-90	30-40-50	25-35-45	70-85-100	65-75-85	90-120-150
	f	0,20-0,25-0,30	0,20-0,25-0,30	0,14-0,17-0,20	0,10-0,15-0,20	0,20-0,25-0,30	0,20-0,25-0,30	0,25-0,30-0,35

Min. - Optimum - Max.



### ■ XGHS Series

Applications	Series	Diameter Range (mm)	Hole Depth (L/D)
Deep Hole Drilling	MDW0000XHGS12	Ø 3,0 – 12,0	-12
	MDW0000XHGS15	Ø 3,0 – 12,0	-15
	MDW0000XHGS20	Ø 3,0 – 12,0	-20
	MDW0000XHGS25	Ø 3,0 – 12,0	-25
	MDW0000XHGS30	Ø 3,0 – 10,0	-30
Pilot Hole Drilling	MDW0000PHT	Ø 3,0 – 12,0	-2

### ■ General Features

Super MultiDrill XHGS series is a next-generation drill for deep hole drilling, features stable chip control and improved strength to further enhance efficiency of deep hole drilling.

### ■ Characteristics and Applications

#### Low Cutting Resistance

The application of a new special thinning shape „RX thinning“ reduces cutting resistance during high efficiency drilling.

**RX**  
THINNING

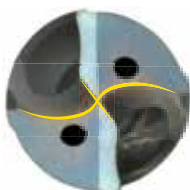

#### Conventional Drill

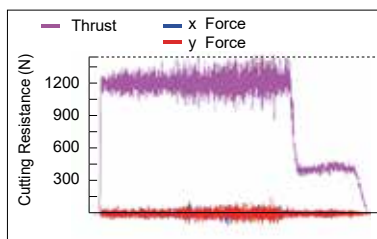

#### XHGS Series

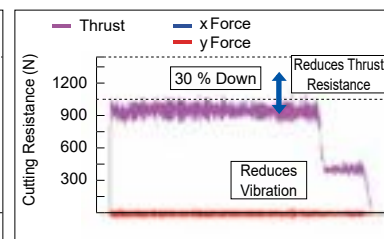

Work Material: C45  
 Tools: MDW050XHT20 (conventional), MDW0500XHGS20 (Ø 5,0 mm, 20D)  
 Cutting Cond.:  $v_c = 80$  m/min,  $f = 0,35$  mm/rev, ( $\Rightarrow$  at the time of entry penetration  $f = 0,08$  mm/rev),  $H = 90$  mm  
 Coolant: MQL

#### Chip Control

New groove shape „J flute“ with improved chip control stability when drilling deep holes.

**J-flute**



XHGS Series



Conv. Drill



$f = 0,35$  mm/rev

$f = 0,40$  mm/rev

$f = 0,45$  mm/rev

Improved chip evacuation makes it possible to reduce spindle load fluctuation, ensuring stable, long tool life.

Work Material: C45  
 Tools: MDW050XHT20 (conventional), MDW0500XHGS20 (Ø 5,0 mm, 20D)  
 Cutting Cond.:  $v_c = 80$  m/min,  $H = 90$  mm  
 Coolant: MQL

#### High Precision & Stability

The XHGS series provides excellent guide performance due to the unique design when compared to the conventional drill.





Recommended Cutting Conditions

Min. - Optimum - Max.

Drill Diameter DC (mm)	Cutting Conditions	Soft Steel (-200 HB)	General Steel (-250 HB)	Alloy Steel (-300 HB)	Hardened Steel (-40 HRC)	Cast Iron FC FCD
-Ø 3,0	v <sub>c</sub>	50-60-80	60-80-100	40-55-70	30-40-50	40-55-70
	f	0,12-0,15-0,20	0,12-0,15-0,20	0,10-0,13-0,16	0,06-0,08-0,12	0,15-0,18-0,23
-Ø 5,0	v <sub>c</sub>	50-60-80	60-80-100	50-60-70	30-45-55	50-60-70
	f	0,15-0,20-0,25	0,15-0,23-0,30	0,12-0,15-0,20	0,08-0,10-0,14	0,17-0,25-0,35
-Ø 10,0	v <sub>c</sub>	50-70-90	60-80-110	50-65-80	30-50-60	50-65-80
	f	0,20-0,25-0,30	0,20-0,25-0,32	0,15-0,20-0,25	0,10-0,15-0,20	0,25-0,28-0,35
-Ø 12,0	v <sub>c</sub>	60-80-100	60-90-120	50-65-80	40-55-70	50-65-80
	f	0,25-0,30-0,35	0,25-0,30-0,35	0,15-0,23-0,27	0,12-0,15-0,23	0,25-0,30-0,35

Note: Use lower speed when using MQL coolant and higher speed when using internal coolant.

V<sub>c</sub>: Cutting speed (m/min), f: Feed Rate (mm/rev)

Recommended Drilling Method

1. Drill a pilot hole using the dedicated PHT

Select the same nominal diameter for the dedicated pilot hole drill PHT type as the deep hole drill XHGS type. (The pilot drill diameter is designed +0,02 mm to +0,05 mm larger than the long drill diameter)

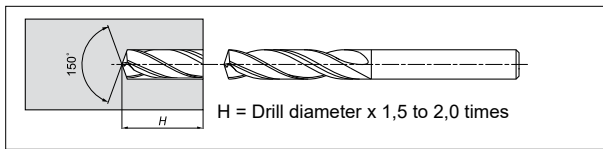

2. Enter the pilot hole at reduced cutting data

Rotation speed: 500 min<sup>-1</sup>  
Feed rate: 1000 to 2000 mm/min

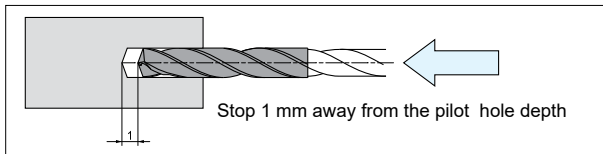

Important:

DO NOT enter pilot hole at higher cutting data, this will cause damage to the drill.

3. Increase rotation speed until the set cutting speed is reached, and start normal drilling operation

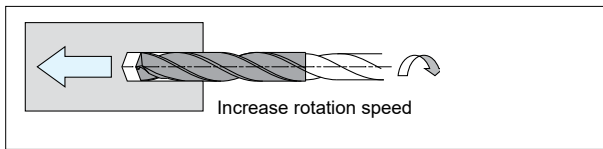

When using a NC machine, only begin drilling operation once full rotation speed is reached.

4. After drilling rotation speed is reduced and the drill is retracted from the work material

Rotation speed: 500 min<sup>-1</sup>  
Feed rate: 1.000 to 2.000 mm/min

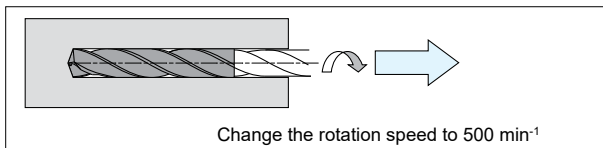

Retracting a drill from the work material at a high rotation speed is dangerous as doing so may result in breakage due to run-out.

5. Other Notes

A flat base should be prepared when the surface for the pilot tool is slanted. Spot face using:

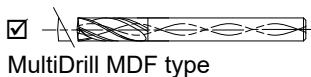

When the deep hole drill exits through an angle surface, decrease the feed rate to f = 0,05 mm/rev just before drilling through.

Coolant

1. Internal coolant supply

Use suitable coolant / emulsion

Pump pressure: Steel: 1,5 to 2,0 MPa (cooling effect increases at higher pressure, affecting chips/wear)  
Cast iron & aluminium alloy: 4,0 to 6,0 MPa (priority on cooling)

2. Internal MQL

Airpressure: 0,5 MPa or higher

Discharge volume: It is recommended to set the maximum discharge volume possible on the machine.

\*Consult the manufacturer before using with aluminium alloy.



# Extra Long SUPER MULTI-DRILLS MDW ... XHGS/PHT Type

## Solid Carbide Drills for Deep Hole Drilling

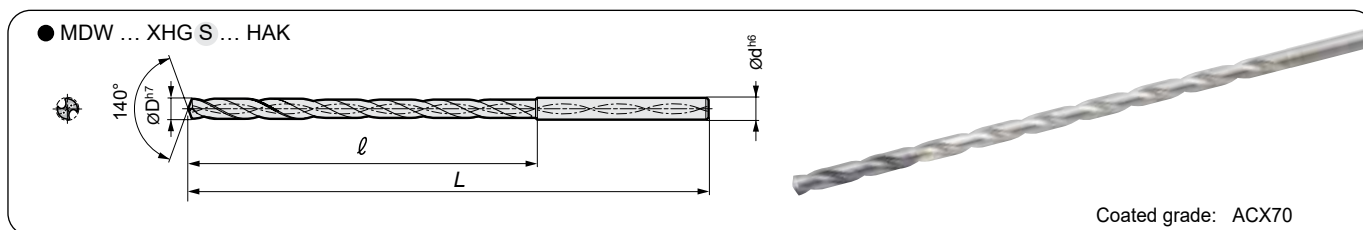

### P ● MDW...XHGS Type for Deep Hole Drilling, Diameter Ø 3,0–12,0 mm (mm)

Dimensions		Cat. No. 12, 15, 20, 25, 30	For 12 x D		For 15 x D		For 20 x D		For 25 x D		For 30 x D	
DC (mm)	ød (mm)		Stock	Dimensions L    ℓ	Stock	Dimensions L    ℓ	Stock	Dimensions L    ℓ	Stock	Dimensions L    ℓ	Stock	Dimensions L    ℓ
3,0	4,0	MDW 0300XHGS □□ HAK	●	85 57	●	94 66	●	109 81	●	124 96	●	139 111
3,5		0350XHGS □□ HAK	●	89 61	●	100 72	●	117 89	●	135 107	●	152 124
4,0		0400XHGS □□ HAK	●	95 67	●	107 79	●	127 99	●	147 119	●	167 139
4,5	5,0	MDW 0450XHGS □□ HAK	●	104 76	●	118 90	●	140 112	●	163 135	●	184 156
5,0		0500XHGS □□ HAK <sup>5*</sup>	●	108 80	●	123 95	●	148 120	●	173 145	●	198 170
5,0	6,0	MDW 0500XHGS □□ HAK	●	116 80	●	131 95	●	156 120	●	181 145	●	206 170
5,5		0550XHGS □□ HAK	●	124 88	●	141 105	●	168 132	●	196 160	●	223 187
6,0		0600XHGS □□ HAK	●	130 94	●	148 112	●	178 142	●	208 172	●	238 202
6,5	8,0	MDW 0650XHGS □□ HAK	●	138 102	●	158 122	●	190 154	●	223 187	●	255 219
6,8		0680XHGS □□ HAK	●	144 108	●	164 128	●	198 162	●	236 200	●	266 230
7,0		0700XHGS □□ HAK	●	145 109	●	166 130	●	201 165	●	236 200	●	271 235
7,5		0750XHGS □□ HAK	●	151 115	●	174 138	●	211 175	●	249 213	●	286 250
8,0		0800XHGS □□ HAK	●	157 121	●	181 145	●	221 185	●	261 225	●	301 265
8,5	10,0	MDW 0850XHGS □□ HAK	●	171 131	●	197 157	●	239 199	●	282 242	●	324 284
9,0		0900XHGS □□ HAK	●	177 137	●	204 164	●	249 209	●	294 254	●	339 299
9,5		0950XHGS □□ HAK	●	183 143	●	212 172	●	259 219	●	305 265	●	352 312
10,0		1000XHGS □□ HAK	●	187 147	●	217 177	●	267 227	●	317 277	●	367 327
10,5	12,0	MDW 1050XHGS □□ HAK	●	202 157	●	234 189	●	286 241	●	339 294	-	- -
11,0		1100XHGS □□ HAK	●	208 163	●	241 196	●	296 251	●	351 306	-	- -
11,5		1150XHGS □□ HAK	●	213 168	●	248 203	●	305 260	●	363 318	-	- -
12,0		1200XHGS □□ HAK	●	219 174	●	255 210	●	315 270	●	375 330	-	- -

(\* ) Cat. No. description: Drill-Ø = 5 mm, shank-Ø = 5 mm (E.g. for 20 x D: MDW050XHGS20HAK5)

Non-standard diameters and lengths on request (Ø 2,5–16,0 mm possible)



### ● MDW...PHT Type for Pilot Hole

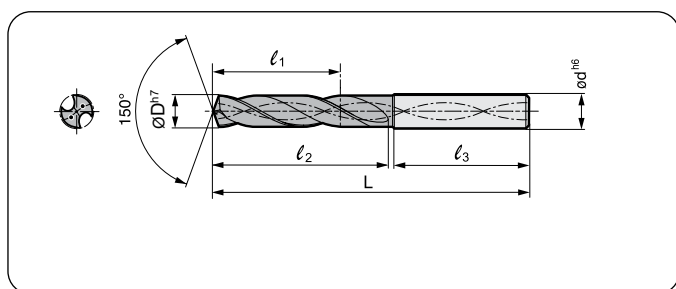

Dimensions		Cat. No.	Stock	For Pilot Hole			
DC (mm)	ød (mm)			L	ℓ <sub>1</sub>	ℓ <sub>2</sub>	ℓ <sub>3</sub>
3,03	4,0	MDW 0303 PHT	●	52	9	22	28
3,53		0353 PHT	●	52	9	22	28
4,03	5,0	MDW 0403 PHT	●	59	12	29	28
4,53		0453 PHT	●	59	12	29	28
5,03	6,0	MDW 0503 PHT	●	71	15	33	36
5,53		0553 PHT	●	71	15	33	36
6,03	8,0	MDW 0603 PHT	●	76	18	38	36
6,53		0653 PHT	●	76	18	38	36
6,83		0683 PHT	●	76	18	38	36
7,03		0703 PHT	●	82	21	43	36
7,53		0753 PHT	●	82	21	43	36
8,03	10,0	MDW 0803 PHT	●	88	24	46	40
8,53		0853 PHT	●	88	24	46	40
9,03		0903 PHT	●	88	24	46	40
9,53		0953 PHT	●	88	24	46	40
10,03	12,0	MDW 1003 PHT	●	104	30	55	45
10,53		1053 PHT	●	104	30	55	45
11,03		1103 PHT	●	104	30	55	45
11,53		1153 PHT	●	104	30	55	45
12,03	14,0	MDW 1203 PHT	●	117	42	68	45

### ■ How to Order

Non stock items – minimum order 6 pieces

Always specify the catalogue number and drill diameter as shown

- eg drill diameter 5,0 mm = MDW 050

E.g.,

**MDW 050 X H G S 30 HAK ACX70** (Grade)

Super  
MULTI-DRILL

DC = 5,0 mm

Extra long type

With spiral coolant holes

Shank type to DIN6535

Drilling depth (L/D ratio)

Cutting edges for steel with double margin

Special shape (RX thinning) + J flute

● = Euro stock

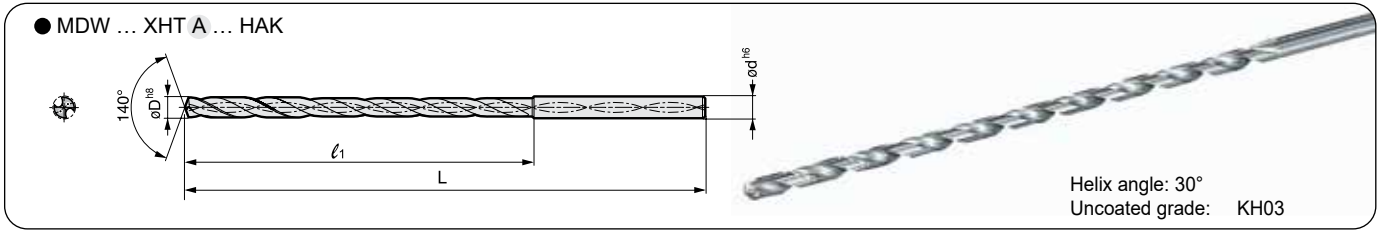

## N ● MDW...XHT A Type for Aluminium and Copper Alloys

Dimensions		Cat. No. 20, 30	For 20 x D			For 30 x D		
DC (mm)	$\varnothing d$ (mm)		Stock	Dimensions		Stock	Dimensions	
			20	L	$l_1$	30	L	$l_1$
4,0	4,0	MDW 040XHT A□□ HAK	●	127	97	●	167	137
5,0	6,0	MDW 050XHT A□□ HAK	●	156	118	●	206	168
6,0		060XHT A□□ HAK	●	178	138	●	238	198
7,0	8,0	MDW 070XHT A□□ HAK	●	201	162	●	271	232
8,0		080XHT A□□ HAK	●	221	182	●	301	262
9,0	10,0	MDW 090XHT A□□ HAK	●	249	205	●	339	295
10,0		100XHT A□□ HAK	●	267	225	●	367	325

⇒ All Long Drill series include an allowance to accommodate regrinding!  
⇒ Uncoated carbide grade: KH03

### How to Order

Non stock items – minimum order 6 pieces  
Always specify the catalogue number and drill diameter as shown  
- eg drill diameter 5,0 mm = MDW 050

E.g.,

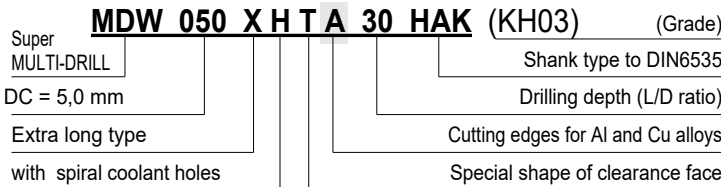

### Recommended Cutting Conditions

V<sub>c</sub>: Cutting speed (m/min), f: Feed Rate (mm/rev)

Drill Ø (mm)	Work material	
	Aluminium Alloy	
-Ø 5,0	V <sub>c</sub>	80–160
	f	0,08–0,30
-Ø 6,0	V <sub>c</sub>	80–160
	f	0,12–0,35
-Ø 8,0	V <sub>c</sub>	80–180
	f	0,15–0,40
-Ø 10,0	V <sub>c</sub>	80–180
	f	0,20–0,50
-Ø 12,0	V <sub>c</sub>	80–180
	f	0,20–0,45



## ● MDW...PHT Type for Pilot Hole

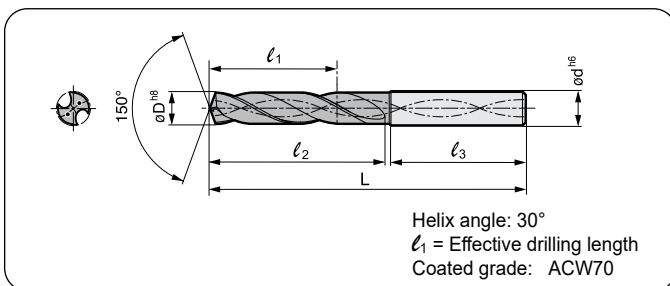

### How to Order

Non stock items – minimum order 6 pieces  
Always specify the catalogue number and drill diameter as shown -  
eg. drill diameter 5,03 mm = MDW 0503

E.g.,

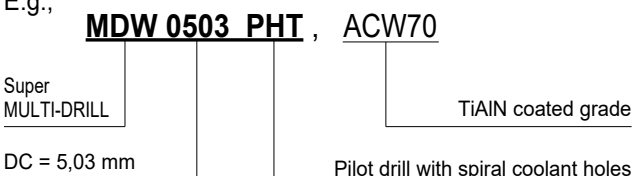

Dimensions		Cat. No.	Stock	For Pilot Hole			
DC (mm)	$\varnothing d$ (mm)			Dimensions (mm)			
				L	$l_1$	$l_2$	$l_3$
3,03	4,0	MDW 0303 PHT	●	52	9	22	28
3,53		0353 PHT	●	52	9	22	28
4,03	5,0	MDW 0403 PHT	●	59	12	29	28
4,53		0453 PHT	●	59	12	29	28
5,03	6,0	MDW 0503 PHT	●	71	15	33	36
5,53		0553 PHT	●	71	15	33	36
6,03	8,0	MDW 0603 PHT	●	76	18	38	36
6,53		0653 PHT	●	76	18	38	36
6,83		0683 PHT	●	76	18	38	36
7,03		0703 PHT	●	82	21	43	36
7,53		0753 PHT	●	82	21	43	36
8,03		10,0	MDW 0803 PHT	●	88	24	46
8,53	0853 PHT		●	88	24	46	40
9,03	0903 PHT		●	88	24	46	40
9,53	0953 PHT		●	88	24	46	40
10,03	12,0		MDW 1003 PHT	●	104	30	55
10,53		1053 PHT	●	104	30	55	45
11,03		1103 PHT	●	104	30	55	45
11,53		1153 PHT	●	104	30	55	45
12,03		14,0	MDW 1203 PHT	●	117	42	68

# AURORA COAT SERIES MDW ... NHGS Type

DLC (Diamond Like Carbon) Coated Multi-Drills

With Coolant Holes (3D/5D/10D)

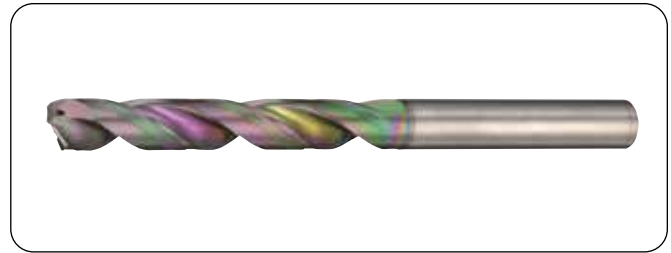

● Diameter Ø 3,0–8,0 mm

Dimensions		Cat. No.	3D Type		5D Type		10D Type				
øD	ød		Stock	Dimensions	Stock	Dimensions	Stock	Dimensions			
			3	L	ℓ	5	L	ℓ	10	L	ℓ
<b>3,0</b>	3,0	MDW 0300 NHGS□□	○	68,6	18,1	○	78,6	28,6	○	92,6	42,6
3,1	4,0	MDW 0310 NHGS□□		72,8	20,7	○	32,7	28,6	○	92,6	42,6
3,2		MDW 0320 NHGS□□	○			○					
3,3		MDW 0330 NHGS□□	○			○					
3,4		MDW 0340 NHGS□□	○			○					
3,5		MDW 0350 NHGS□□	□			○					
3,6		MDW 0360 NHGS□□				○					
3,65		MDW 0365 NHGS□□	□			○					
3,66		MDW 0366 NHGS□□				○					
3,7		MDW 0370 NHGS□□				○					
3,8		MDW 0380 NHGS□□				○					
3,9	MDW 0390 NHGS□□		○								
<b>4,0</b>	MDW 0400 NHGS□□	○			○			○			
4,1	5,0	MDW 0410 NHGS□□	○	81,0	25,9	○	40,9	28,6		92,6	42,6
4,2		MDW 0420 NHGS□□	○			○					
4,3		MDW 0430 NHGS□□				○					
4,4		MDW 0440 NHGS□□				○					
4,5		MDW 0450 NHGS□□	○			○					
4,6		MDW 0460 NHGS□□	○			○					
4,7		MDW 0470 NHGS□□				○					
4,8		MDW 0480 NHGS□□				○					
4,9		MDW 0490 NHGS□□				○					
<b>5,0</b>		MDW 0500 NHGS□□	○								
5,1	6,0	MDW 0510 NHGS□□		83,2	28,6	○	45,1	28,6	○	92,6	42,6
5,2		MDW 0520 NHGS□□	□			○					
5,3		MDW 0530 NHGS□□	○			○					
5,4		MDW 0540 NHGS□□				○					
5,5		MDW 0550 NHGS□□	○			○					
5,6		MDW 0560 NHGS□□				○					
5,7		MDW 0570 NHGS□□				○					
5,8		MDW 0580 NHGS□□				○					
5,9		MDW 0590 NHGS□□	□			○					
<b>6,0</b>		MDW 0600 NHGS□□	○								
6,1	7,0	MDW 0610 NHGS□□		89,5	33,8	○	53,3	28,6	○	92,6	42,6
6,2		MDW 0620 NHGS□□				○					
6,3		MDW 0630 NHGS□□				○					
6,4		MDW 0640 NHGS□□				○					
6,5		MDW 0650 NHGS□□	○			○					
6,6		MDW 0660 NHGS□□				○					
6,7		MDW 0670 NHGS□□	□			○					
6,8		MDW 0680 NHGS□□	○			○					
6,9		MDW 0690 NHGS□□				○					
<b>7,0</b>		MDW 0700 NHGS□□	○								
7,1	8,0	MDW 0710 NHGS□□		95,7	39,1	○	61,6	28,6	○	92,6	42,6
7,2		MDW 0720 NHGS□□				○					
7,3		MDW 0730 NHGS□□				○					
7,35		MDW 0735 NHGS□□	○			○					
7,4		MDW 0740 NHGS□□				○					
7,5		MDW 0750 NHGS□□	□			○					
7,6		MDW 0760 NHGS□□				○					
7,7		MDW 0770 NHGS□□				○					
7,8		MDW 0780 NHGS□□				○					
7,9		MDW 0790 NHGS□□	○			○					
<b>8,0</b>	MDW 0800 NHGS□□	○			○			○			

## ■ Characteristics

- High efficiency drilling  
AURORA COAT and strong helix design reduces cutting forces and improves edge sharpness.
- Precision drilling  
Special cutting edge design improves hole precision and quality.
- Longer tool life  
With AURORA COAT coupled with the cutting edge design, long and stable tool life can be achieved.
- Deep hole (L/D = 20) drilling  
Drills for deep hole drilling can be custom-made.  
Production range: Ø 3,0–16,0 mm  
total length: 50 times drill diameter (max. 290 mm)

## ■ Applicable Work Materials

- Aluminium Die Casting
- Aluminium Alloy
- Aluminium Alloy Casting
- Brass Casting
- Bronze Casting

## ■ Comparison of Cutting Force (Thrust Force)

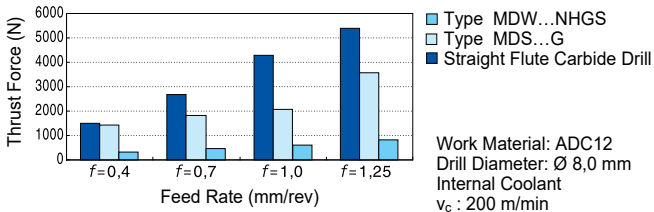

## ■ Recommended Cutting Conditions

Diameter (mm)		Aluminium Alloy	Aluminium Die Casting	Copper Alloy
-Ø 5	vc	80–160	80–180	80–160
	f	0,08–0,30	0,10–0,30	0,08–0,15
-Ø 10	vc	80–180	80–200	60–180
	f	0,10–0,30	0,10–0,35	0,10–0,20
-Ø 16	vc	80–200	80–200	80–200
	f	0,15–0,40	0,10–0,40	0,10–0,25

(vc : Cutting Speed (m/min), f : Feed rate (mm/rev), Min–Max )

AURORA Coated NHGS Type, Grade: DL1300

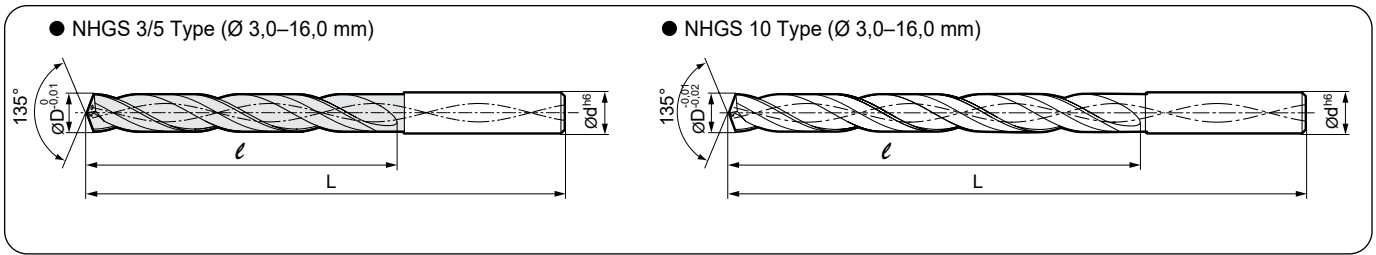

● Diameter Ø 8,1–13,0 mm (mm)

Dimensions		Cat. No.	3D Type		5D Type			10D Type		
ØD	Ød		Stock	Dimensions	Stock	Dimensions	Stock	Dimensions	Stock	Dimensions
		3, 5, 10	3	L	5	L	ℓ	10	L	ℓ
8,1	9,0	MDW 0810 NHGS□□			□					
8,2		MDW 0820 NHGS□□			○					
8,3		MDW 0830 NHGS□□		44,3	○		69,8			118,8
8,4		MDW 0840 NHGS□□			○					
8,5		MDW 0850 NHGS□□	○	101,9	○		128,9	○		182,9
8,6		MDW 0860 NHGS□□	□		○					
8,7		MDW 0870 NHGS□□			□					
8,8		MDW 0880 NHGS□□	○	46,9	□		73,9			127,9
8,9		MDW 0890 NHGS□□			□					
9,0		MDW 0900 NHGS□□	○		○			○		
9,1	10,0	MDW 0910 NHGS□□			□					
9,2		MDW 0920 NHGS□□			□					
9,21		MDW 0921 NHGS□□	□		□					
9,3		MDW 0930 NHGS□□		49,5	○		78,0			135,0
9,4		MDW 0940 NHGS□□	□		□					
9,5		MDW 0950 NHGS□□	□	108,0	○		138,0	□		198,0
9,6		MDW 0960 NHGS□□			□					
9,7		MDW 0970 NHGS□□			□					
9,8		MDW 0980 NHGS□□		52,0	○		82,0	○		142,0
9,9		MDW 0990 NHGS□□			○					
10,0	MDW 1000 NHGS□□	○		○			○			
10,1	11,0	MDW 1010 NHGS□□	□							
10,2		MDW 1020 NHGS□□								
10,3		MDW 1030 NHGS□□	□	54,7	□		86,2			149,2
10,4		MDW 1040 NHGS□□			□					
10,5		MDW 1050 NHGS□□	○	168,3	□		151,3	□		217,3
10,6		MDW 1060 NHGS□□	□		□					
10,7		MDW 1070 NHGS□□								
10,8		MDW 1080 NHGS□□		57,3			90,3			156,3
10,9		MDW 1090 NHGS□□								
11,0		MDW 1100 NHGS□□	○		○			○		
11,08	12,0	MDW 1108 NHGS□□	□							
11,1		MDW 1110 NHGS□□	□							
11,2		MDW 1120 NHGS□□	○							
11,3		MDW 1130 NHGS□□		59,9	□		94,4			163,4
11,4		MDW 1140 NHGS□□	□		□					
11,5		MDW 1150 NHGS□□	○	124,5	□		160,5	□		232,5
11,6		MDW 1160 NHGS□□								
11,7		MDW 1170 NHGS□□								
11,8		MDW 1180 NHGS□□		62,5			98,5			170,5
11,9		MDW 1190 NHGS□□								
12,0	MDW 1200 NHGS□□	○		○			○			
12,1	13,0	MDW 1210 NHGS□□	□							
12,2		MDW 1220 NHGS□□								
12,3		MDW 1230 NHGS□□	□	65,1	□		102,6			177,6
12,4		MDW 1240 NHGS□□								
12,5		MDW 1250 NHGS□□	□		○			□		
12,6		MDW 1260 NHGS□□		130,7			169,7			247,7
12,7		MDW 1270 NHGS□□								
12,8		MDW 1280 NHGS□□								
12,9		MDW 1290 NHGS□□		67,7			106,7			184,7
12,96		MDW 1296 NHGS□□								
13,0	MDW 1300 NHGS□□	○		○			○			

● Diameter Ø 13,1–16,0 mm (mm)

Dimensions		Cat. No.	3D Type		5D Type			10D Type			
ØD	Ød		Stock	Dimensions	Stock	Dimensions	Stock	Dimensions	Stock	Dimensions	
		3, 5, 10	3	L	ℓ	5	L	ℓ	10	L	ℓ
13,1	14,0	MDW 1310 NHGS□□									
13,2		MDW 1320 NHGS□□									
13,3		MDW 1330 NHGS□□		70,8			110,8				191,8
13,4		MDW 1340 NHGS□□									
13,5		MDW 1350 NHGS□□	○	136,9			178,9	○			262,9
13,6		MDW 1360 NHGS□□									
13,7		MDW 1370 NHGS□□									
13,8		MDW 1380 NHGS□□		72,9			114,9				198,9
13,9		MDW 1390 NHGS□□									
14,0		MDW 1400 NHGS□□	○					○			
14,1	15,0	MDW 1410 NHGS□□	□								
14,2		MDW 1420 NHGS□□									
14,3		MDW 1430 NHGS□□		75,5			119,0				206
14,4		MDW 1440 NHGS□□									
14,5		MDW 1450 NHGS□□	○					○			
14,6		MDW 1460 NHGS□□		141,1			188,1				278,1
14,7		MDW 1470 NHGS□□									
14,8		MDW 1480 NHGS□□									
14,9		MDW 1490 NHGS□□	□	78,1			123,1				213,1
14,96		MDW 1496 NHGS□□	□					□			
15,0	MDW 1500 NHGS□□	○					○				
15,1	16,0	MDW 1510 NHGS□□									
15,2		MDW 1520 NHGS□□									
15,3		MDW 1530 NHGS□□		80,7			127,2				220,2
15,4		MDW 1540 NHGS□□									
15,5		MDW 1550 NHGS□□	○	149,3			197,3				293,3
15,6		MDW 1560 NHGS□□									
15,7		MDW 1570 NHGS□□									
15,8		MDW 1580 NHGS□□		83,3			131,3				227,3
15,9		MDW 1590 NHGS□□									
16,0		MDW 1600 NHGS□□	○					○			

AURORA Coated NHGS Type, Grade: DL1300

■ How to Order

Non-Stock Items will be required minimum order quantity for 6 pcs.

Please specify the Cat. No.

For example, if the diameter of the drill is 10,3 mm and the ratio to ØD is 5, please indicate as follow.

E.g.,

**MDW 1030 NHGS 5**, **DL1300** (Grade)

Super MULTI-DRILL

DC = 10,3 mm

Applicable work materials

with spiral coolant holes

Drilling depth (The ratio to ØD):  
-3 / -5 / -10

NHGS type Multi-Drills

# Micro Long Drills

## MLDH ...L/P Type



### ■ General Features

Micro Long Drills are oil-hole drills for high efficiency drilling that were developed for drilling deep, small-diameter holes. These next-generation, small-diameter hole drills feature improved strength - often a problem area with small-diameter drills.

### ■ Characteristics and Applications

- Deep-hole drilling  
New groove shape ensures good drill rigidity and chip evacuation.  
High efficiency drilling to depths of over 20 x drill diameter at over  $v_f = 500$  mm/min (drill diameter 1,3 mm, X12CrS13 equivalent).  
Optimal thinning and edge balance for stable chip control.
- Long tool life  
Special coating provides long tool life with a wide variety of work materials.  
Improved chip evacuation makes it possible to reduce spindle load fluctuation, ensuring stable tool life.

### ■ Series

Application	Type	Diameter Range (mm)	Hole Depth (L/D)
Guide Hole Drilling	MLDH □□□□ P	Ø 0,8 – 2,0	–2
Deep Hole Drilling	MLDH □□□□ L5	Ø 0,8 – 2,0	–5
	MLDH □□□□ L12	Ø 0,8 – 2,0	–12
	MLDH □□□□ L20	Ø 0,8 – 2,0	–20
	MLDH □□□□ L30	Ø 0,8 – 2,0	–30

### ■ Recommended Cutting Conditions

#### ● MLDH ... P / L5

( $v_c$ : Cutting Speed (m/min),  $f$ : Feed rate (mm/rev), Min - Optimum - Max )

Drill-ø (mm)	Cutting Cond.	Soft Steel (-200 HB)	General Steel (200–250 HB)	Alloy Steel (250–300 HB)	Stainless Steel (-200 HB)	Cast Iron	Aluminium Alloy	Heat-Resistant Steels
-Ø 1,0	$v_c$	40–50–60	40–50–60	40–50–60	20–30–40	40–50–60	50–60–70	5–10–15
	$f$	0,01–0,02–0,03	0,01–0,02–0,03	0,01–0,02–0,03	0,01–0,02–0,03	0,02–0,03–0,04	0,03–0,04–0,06	0,005–0,01–0,02
-Ø 1,5	$v_c$	40–50–60	40–50–60	40–50–60	20–30–40	40–50–60	50–60–70	5–10–15
	$f$	0,04–0,08–0,12	0,04–0,08–0,12	0,04–0,08–0,12	0,02–0,05–0,10	0,04–0,08–0,12	0,05–0,10–0,15	0,01–0,03–0,05
-Ø 2,0	$v_c$	40–50–60	40–50–60	40–50–60	20–30–40	40–50–60	50–60–70	5–10–15
	$f$	0,06–0,08–0,12	0,06–0,08–0,12	0,06–0,08–0,12	0,04–0,06–0,10	0,06–0,08–0,12	0,08–0,12–0,15	0,01–0,03–0,05

#### ● MLDH ... L12 / L20 / L30

( $v_c$ : Cutting Speed (m/min),  $f$ : Feed rate (mm/rev), Min - Optimum - Max )

Drill-ø (mm)	Cutting Cond.	Soft Steel (-200 HB)	General Steel (200–250 HB)	Alloy Steel (250–300 HB)	Stainless Steel (-200 HB)	Cast Iron	Aluminium Alloy	Heat-Resistant Steels
-Ø 1,0	$v_c$	40–50–60	40–50–60	40–50–60	20–30–40	40–50–60	50–60–70	5–10–15
	$f$	0,01–0,02–0,03	0,01–0,02–0,03	0,01–0,02–0,03	0,01–0,02–0,03	0,02–0,03–0,04	0,03–0,04–0,06	0,005–0,01–0,02
-Ø 1,5	$v_c$	40–50–60	40–50–60	40–50–60	20–30–40	40–50–60	50–60–70	5–10–15
	$f$	0,03–0,05–0,07	0,03–0,05–0,07	0,03–0,05–0,07	0,02–0,04–0,07	0,04–0,07–0,10	0,05–0,08–0,12	0,01–0,02–0,03
-Ø 2,0	$v_c$	40–50–60	40–50–60	40–50–60	20–30–40	40–50–60	50–60–70	5–10–15
	$f$	0,04–0,06–0,08	0,04–0,06–0,08	0,04–0,06–0,08	0,04–0,06–0,08	0,04–0,07–0,10	0,05–0,08–0,12	0,01–0,02–0,03

○ = Japan stock





MLDH-P



MLDH-L

# Micro Long Drills MLDH ....L/P Type

## Internal Coolant Supply

● MLDH-P For Pilot Hole Drilling

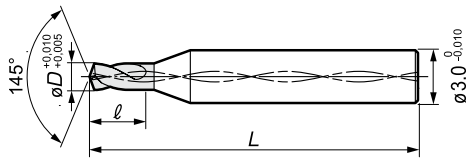

● MLDH-L For Deep Hole Drilling

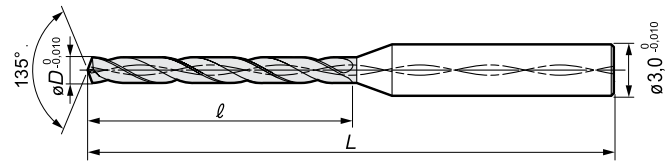

## Stock

(mm)

ØD (mm)	P Type for Pilot Hole Drilling			L Type for Deep Hole Drilling																																																																																																	
	Cat. No.	Stock	Dimensions		Cat. No. 5, 12, 20, 30	5x D		12x D		20x D		30x D																																																																																									
			L	ℓ		Stock	Dimensions	Stock	Dimensions	Stock	Dimensions	Stock	Dimensions																																																																																								
0,80	MLDH 0800P	○	45	3,2	MLDH 0800L□□	○	8	○	○	○	19	○	28																																																																																								
0,81	0810P	○			MLDH 0810L□□	○	50	9	55	14	60	○		20																																																																																							
0,82	MLDH 0820P	○			MLDH 0820L□□	○						10			60	15	65	○	21																																																																																		
0,83	0830P	○			MLDH 0830L□□	○												12		65	16	70	○	22																																																																													
0,84	MLDH 0840P	○			MLDH 0840L□□	○																	14		70	17	75	○	23																																																																								
0,85	0850P	○			MLDH 0850L□□	○																						16		75	18	80	○	24																																																																			
0,86	0860P	○			MLDH 0860L□□	○																											18		80	19	85	○	25																																																														
0,87	MLDH 0870P	○			MLDH 0870L□□	○																																20		85	20	90	○	26																																																									
0,88	0880P	○			MLDH 0880L□□	○																																					22		90	21	95	○	27																																																				
0,89	MLDH 0890P	○			MLDH 0890L□□	○																																										24		95	22	100	○	28																																															
0,90	0900P	○			MLDH 0900L□□	○																																															26		100	23	105	○	29																																										
0,91	0910P	○			MLDH 0910L□□	○																																																				28		105	24	110	○	30																																					
0,92	MLDH 0920P	○			MLDH 0920L□□	○																																																									30		110	25	115	○	31																																
0,93	0930P	○			MLDH 0930L□□	○																																																														32		115	26	120	○	32																											
0,94	MLDH 0940P	○			MLDH 0940L□□	○																																																																			34		120	27	125	○	33																						
0,95	0950P	○			MLDH 0950L□□	○																																																																								36		125	28	130	○	34																	
0,96	0960P	○			MLDH 0960L□□	○																																																																													38		130	29	135	○	35												
0,97	MLDH 0970P	○			MLDH 0970L□□	○																																																																																		40		135	30	140	○	36							
0,98	0980P	○			MLDH 0980L□□	○																																																																																							42		140	31	145	○	37		
0,99	MLDH 0990P	○			MLDH 0990L□□	○																																																																																												44		145	32
1,00	1000P	○	MLDH 1000L□□	○	46	150							33																																																																																								
1,05	MLDH 1050P	○	MLDH 1050L□□	○			48	155	34	160	○			40																																																																																							
1,10	MLDH 1100P	○	MLDH 1100L□□	○							50	160			35	165	○		41																																																																																		
1,15	MLDH 1150P	○	MLDH 1150L□□	○													52	165		36	170	○		42																																																																													
1,20	MLDH 1200P	○	MLDH 1200L□□	○																		54	170		37	175	○		43																																																																								
1,25	MLDH 1250P	○	MLDH 1250L□□	○																							56	175		38	180	○		44																																																																			
1,30	MLDH 1300P	○	MLDH 1300L□□	○																												58	180		39	185	○		45																																																														
1,35	MLDH 1350P	○	MLDH 1350L□□	○																																	60	185		40	190	○		46																																																									
1,40	MLDH 1400P	○	MLDH 1400L□□	○																																						62	190		41	195	○		47																																																				
1,45	MLDH 1450P	○	MLDH 1450L□□	○																																											64	195		42	200	○		48																																															
1,50	MLDH 1500P	○	MLDH 1500L□□	○																																																66	200		43	205	○		49																																										
1,55	MLDH 1550P	○	MLDH 1550L□□	○																																																					68	205		44	210	○		50																																					
1,60	MLDH 1600P	○	MLDH 1600L□□	○																																																										70	210		45	215	○		51																																
1,65	MLDH 1650P	○	MLDH 1650L□□	○																																																															72	215		46	220	○		52																											
1,70	MLDH 1700P	○	MLDH 1700L□□	○																																																																				74	220		47	225	○		53																						
1,75	MLDH 1750P	○	MLDH 1750L□□	○																																																																									76	225		48	230	○		54																	
1,80	MLDH 1800P	○	MLDH 1800L□□	○																																																																														78	230		49	235	○		55												
1,85	MLDH 1850P	○	MLDH 1850L□□	○																																																																																			80	235		50	240	○		56							
1,90	MLDH 1900P	○	MLDH 1900L□□	○																																																																																								82	240		51	245	○		57		
1,95	MLDH 1950P	○	MLDH 1950L□□	○																																																																																													84	245		52	250
2,00	MLDH 2000P	○	MLDH 2000L□□	○	86	250							53																																																																																								

PVD Coated Grade: ACV70



# Solid Carbide Micro / MINI-DRILLS

## MDUS / MDSS Type

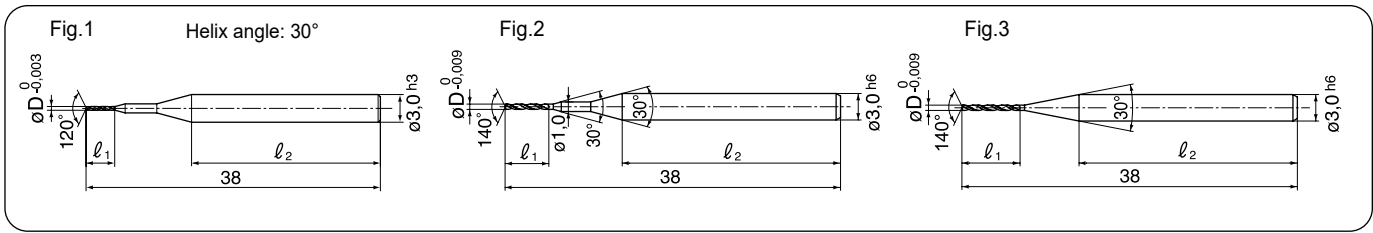

### ● Diameter Ø 0,03–0,19 mm

øD (mm)	Cat. No.	Stock	Dimensions		Fig.	Pcs./Pack-ing	
			l <sub>1</sub>	l <sub>2</sub>			
0,030	MDUS 0030-30C	○	0,3		28	1	
0,035	MDUS 0035-30C						
0,040	MDUS 0040-30C	○	0,4				
0,045	MDUS 0045-30C						
0,050	MDUS 0050-30C	○	0,5				
0,055	MDUS 0055-30C						
0,060	MDUS 0060-30C		0,6				
0,065	MDUS 0065-30C						
0,070	MDUS 0070-30C		0,7				
0,075	MDUS 0075-30C						
0,080	MDUS 0080-30C	○	0,8				
0,085	MDUS 0085-30C						
0,090	MDUS 0090-30C		1,0				
0,095	MDUS 0095-30C						
0,100	MDUS 0100-30C	○					
0,110	MDUS 0110-30C	○	1,2				1
0,120	MDUS 0120-30C						
0,120	MDUS 0130-30C	○					
0,140	MDUS 0140-30C		1,5				
0,150	MDUS 0150-30C						
0,160	MDUS 0160-30C	○	1,8				
0,170	MDUS 0170-30C						
0,180	MDUS 0180-30C						
0,190	MDUS 0190-30C		1,9				

### ● Diameter Ø 0,20–0,59 mm

øD (mm)	Cat. No.	Stock	Dimensions		Fig.	Pcs./Pack-ing		
			l <sub>1</sub>	l <sub>2</sub>				
0,20	MDSS 0020	○			2	2,5		
0,21	MDSS 0021	○						
0,22	MDSS 0022	○						
0,23	MDSS 0023	○						
0,24	MDSS 0024	○						
0,25	MDSS 0025	○						
0,26	MDSS 0026	○						
0,27	MDSS 0027	○						
0,28	MDSS 0028	○						
0,29	MDSS 0029	□						
0,30	MDSS 0030	○					1	28
0,31	MDSS 0031	○						
0,32	MDSS 0032	○	3					
0,33	MDSS 0033	○						
0,34	MDSS 0034	○						
0,35	MDSS 0035	○						
0,36	MDSS 0036	○						
0,37	MDSS 0037	○	4					
0,38	MDSS 0038	○						
0,39	MDSS 0039	○						
0,40	MDSS 0040	○			3	27		
0,41	MDSS 0041	○						
0,42	MDSS 0042	○						
0,43	MDSS 0043	○						
0,44	MDSS 0044	○	5					
0,45	MDSS 0045	○						
0,46	MDSS 0046	○						
0,47	MDSS 0047	○						
0,48	MDSS 0048	○						
0,49	MDSS 0049	○						
0,50	MDSS 0050	○			6	27		
0,51	MDSS 0051	○						
0,52	MDSS 0052	○						
0,53	MDSS 0053	○						
0,54	MDSS 0054	○						
0,55	MDSS 0055	○						
0,56	MDSS 0056	○						
0,57	MDSS 0057	○						
0,58	MDSS 0058	○						
0,59	MDSS 0059	○						

### ● Diameter Ø 0,60–1,00 mm

øD (mm)	Cat. No.	Stock	Dimensions		Fig.	Pcs./Pack-ing
			l <sub>1</sub>	l <sub>2</sub>		
0,60	MDSS 0060	○			7	26
0,61	MDSS 0061	○				
0,62	MDSS 0062	○				
0,63	MDSS 0063	○				
0,64	MDSS 0064	○				
0,65	MDSS 0065	○				
0,66	MDSS 0066	○				
0,67	MDSS 0067	○				
0,68	MDSS 0068	○				
0,69	MDSS 0069	○				
0,70	MDSS 0070	○			9	24
0,71	MDSS 0071	○				
0,72	MDSS 0072	○				
0,73	MDSS 0073	○				
0,74	MDSS 0074	□				
0,75	MDSS 0075	○				
0,76	MDSS 0076	○				
0,77	MDSS 0077	○				
0,78	MDSS 0078	○				
0,79	MDSS 0079	○				
0,80	MDSS 0080	○			3	1
0,81	MDSS 0081	○				
0,82	MDSS 0082	○				
0,83	MDSS 0083	○				
0,84	MDSS 0084	○	10	23		
0,85	MDSS 0085	○				
0,86	MDSS 0086	○				
0,87	MDSS 0087	○				
0,88	MDSS 0088	○				
0,89	MDSS 0089	○				
0,90	MDSS 0090	○			11	22
0,91	MDSS 0091	○				
0,92	MDSS 0092	○				
0,93	MDSS 0093	○				
0,94	MDSS 0094	○				
0,95	MDSS 0095	○				
0,96	MDSS 0096	○				
0,97	MDSS 0097	○				
0,98	MDSS 0098	○				
0,99	MDSS 0099	○				
1,00	MDSS 0100	○	12	21		



### ■ MDSS Recommended Cutting Conditions (Wet)

Work Cond.	Alloy Steel, Pre-hardened Steel			Die Steel, Tempered Steel (H <sub>RC</sub> 30–40)			Stainless Steel		
	Spindle (rpm)	Feed rate (mm/min)	Step-feed (mm)	Spindle (rpm)	Feed rate (mm/min)	Step-feed (mm)	Spindle (rpm)	Feed rate (mm/min)	Step-feed (mm)
Ø 0,2	26500	50	0,1D	21200	40	0,1D	10600	20	0,1D
Ø 0,3	26500	80		21200	60		10600	30	
Ø 0,4	25900	100		19900	80		9500	40	
Ø 0,5	25500	150		19100	110		9500	50	
Ø 1,0	15900	240		12700	190		5600	80	

- The above conditions are recommended under wet conditions, using water-soluble coolant.
- If machine noises and vibrations are present, please adjust the cutting conditions accordingly.
- If the machine cannot achieve the recommended spindle speed, please use the max. spindle speed available.

\* Step feed is recommended for drilling of holes deeper than 3xD.

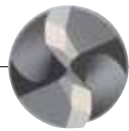

MDS...SDC

# SUMIDIA Coated Drills SDC Type



## General Features

SUMIDIA Coated SDC type drills for Carbon Fibre Reinforced Plastic (CFRP) employ Sumitomo Electric Hardmetal's proprietary multi-step point angle.

Combined with a diamond coating, this technology improves the quality of machined surfaces and extends tool life.

## Characteristics and Applications

- Excellent drilled-hole quality
  - Sharp cutting edge shape reduces delamination of fibre layers and burrs.
  - Continuously changing point angle disperses load placed on cutting edge and prevents breakage.
- Long tool life
  - Use of high-strength diamond coating with excellent adhesion delivers high quality and long tool life.

## Performance

**Comparison of Machined Surface Finish**

Excellent Machined Face Quality  
(Prevents Delamination And Burrs)

	SDC	Concurrent A	Concurrent B	Concurrent C
Hole Entrance				
Hole Exit				

Tool: SUMIDIA coated drill SDC type, Ø 6,375  
Competitor A B C's drill Ø 6,35 & Ø 6,5

Work Material: CFRP

Cutting Conditions: n = 6.000 rpm, f=0,1 mm/rev, a<sub>p</sub> =28 mm (Through)  
Dry

**Tool Life Comparison**

Effects of Diamond Coating

SDC type (After drilling 600 holes)	Competitor's product (After drilling 50 holes)
No delamination Low flank wear	More delamination from cutting edge to flank

Stable diamond layer adhesion prevents delamination.  
Excellent wear resistance enables high-quality drilling with long tool life.

**SDC**

Competitor A's Diamond Coated Drill

Carbide Drill

0 100 200 300 400 500 600 Hole

Tool: SUMIDIA coated drill SDC type, Ø 6,375  
Competitor A B C's drill Ø 6,35 & Ø 6,5

Work Material: CFRP

Cutting Conditions: n = 6.000 rpm, f=0,1 mm/rev, a<sub>p</sub> =28 mm (Through)  
Dry

## Series

Type	Diameter Range (mm)	Point angle	Hole Depth (L/d)
MDS□□□□SDC3	Ø 2,0 – 4,0	90°	-3
	Ø 4,851 – 10,0	130°	

DCX20	SUMI-DIA	Structural Steel	Carbon Steel	Alloy Steel	Precipitated Steel	Tempered Die Steel	Hardened Steel	Stainless Steel	Ti Alloy / Heat Resistant Alloy	Cast Iron	Al Alloy	Cu Alloy	CFRP *
Grade	Coating						45-55 HRC 55-60 HRC 60-65 HRC						○

\* CFRP (Carbon Fibre Reinforced Plastic)

● Diameter Ø 2,0–4,0 mm

● Diameter Ø 4,851–10,0 mm

## ● Diameter ø 2,0–10,0 mm

Dimensions		Cat. No.	3D Type		
DC (mm)	Ød (mm)		Stock	Dimensions	
				L	ℓ
<b>2,0</b>	3,0	MDS 02000SDC3	○	49	12,5
2,489		02489SDC3	○		15,0
<b>3,0</b>		03000SDC3	○		17,5
3,3	4,0	MDS 03300SDC3	○	60	20,0
<b>4,0</b>		04000SDC3	○		22,5
4,851	4,851	MDS 04851SDC3	○	76	27,5
<b>5,0</b>		05000SDC3	○		30,0
<b>5,6</b>	6,0	MDS 05600SDC3	○	81	32,5
<b>6,0</b>		06000SDC3	○		35,0
6,375	6,375	MDS 06375SDC3	○	83	40,0
<b>7,0</b>		07000SDC3	○		45,0
7,938	7,938	MDS 07938SDC3	○	90	45,0
<b>8,0</b>		08000SDC3	○		50,0
<b>9,0</b>	9,550	MDS 09000SDC3	○	105	50,0
9,550		MDS 09550SDC3	○		
<b>10,0</b>	10,0	10000SDC3	○		

## Recommended Cutting Conditions

Work	Cond.	ØD	CFRP Only (Dry Machining)		Stacked Plates of CFRP, Aluminium Alloys (Dry Machining)	
			v <sub>c</sub>	f	v <sub>c</sub>	f
-Ø 6,0	v <sub>c</sub>		80-120-150		40-60-80	
	f		0,05-0,08-0,10		0,05-0,05-0,10	
-Ø 10,0	v <sub>c</sub>		80-100-120		40-60-80	
	f		0,05-0,08-0,10		0,05-0,05-0,10	

(v<sub>c</sub>: Cutting Speed (m/min), f: Feed rate (mm/rev), Min - Optimum - Max )



# Replaceable Head Type MULTI-DRILLS SMD Type

## General Features

Fast accurate and ideal for drilling steels, this newly developed drill from SUMITOMO gives similar hole accuracy to that of regrindable drills renowned within the industry as being the ultimate hole making tool.



- ## Advantages
- Available in diameters ranging from 12,0–42,5 mm
  - Drilling Depths 1,5–12 x Diameter
  - Optimised heat dissipation via precisely located coolant holes
  - Maximised rigidity from newly developed clamping system
  - High performance drilling of precision holes from solid
  - 3 different types of head for general and smooth cutting (MTL type, MEL type) and new MFS type for drilling in non-flat surfaces.

The newly developed tungsten carbide substrate with its ultra hard smooth coating proved that against competition users can expect to see holes with tolerances similar to that of reaming and tool life almost doubled.

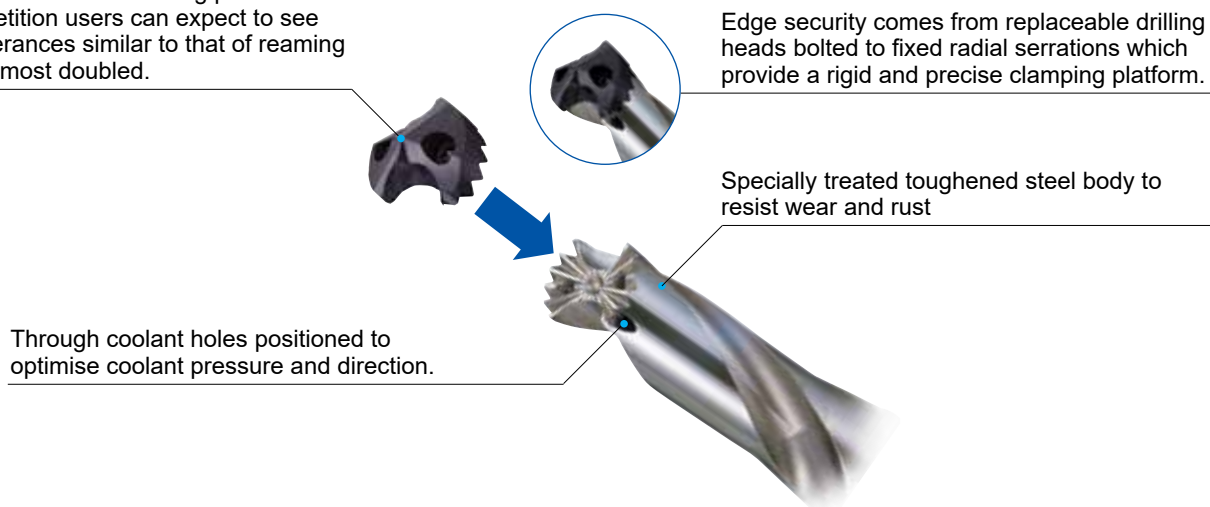

## Drilling Precision

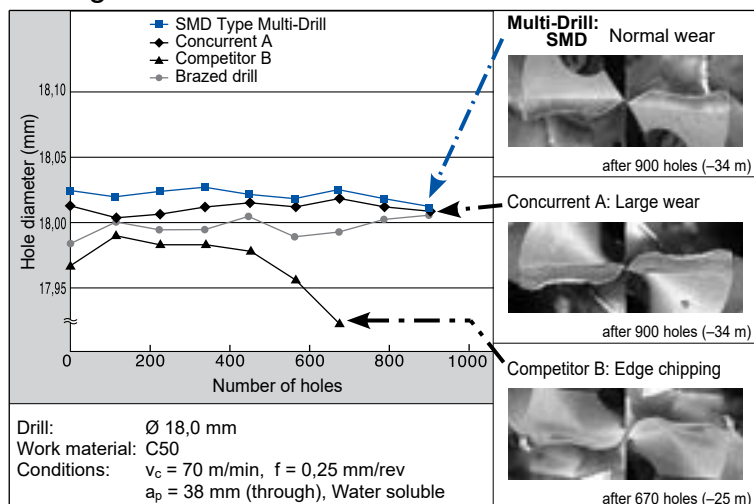

## Application Example

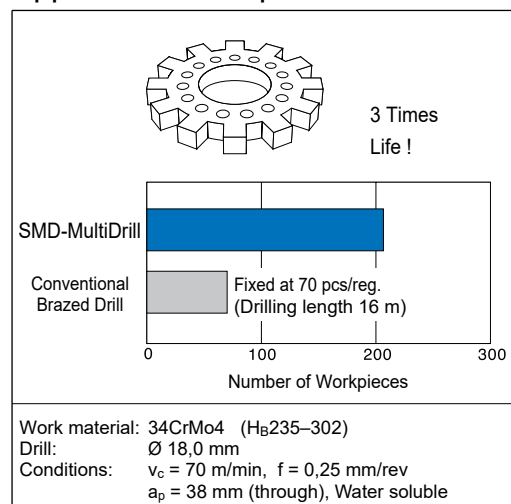

# Replaceable Head Type Drill Holder

## SMDH Type

### ● Holder 3D / 5D / 8D

Shank Type:  
Whistle notch type

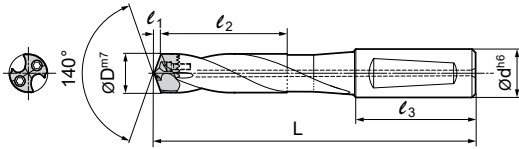

### ● Holder 1,5D

Shank Type:  
Weldon type

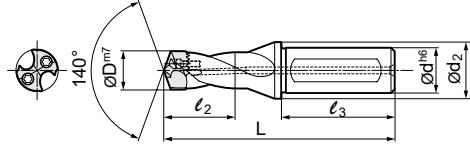

### ● Holder 12D

Shank Type:  
Cylindrical type

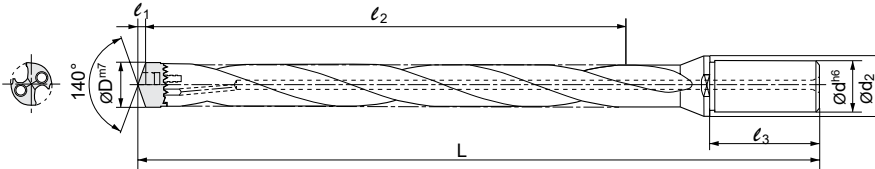

$l_2$  = Effective drilling length

### ■ Holder

(mm)

Dimensions				Cat. No.	Series (1,5D)				Series (3D)				Series (5D)				Series (8D)				Series (12D)				Related Drill Heads DMTL / DMEL	
Drill Head	Shank	Ø D	l <sub>1</sub>		Stock	Dimensions			Stock	Dimensions			Stock	Dimensions			Stock	Dimensions			Stock	Dimensions				
Ø d	l <sub>3</sub>					S	L	l <sub>2</sub>		Ø d <sub>2</sub>	M3	L		l <sub>2</sub>	M5	L		l <sub>2</sub>	M8	L		l <sub>2</sub>	M8	L		l <sub>2</sub>
12,0	2,2	16	48	SMDH 120 □ □	●	91	25,5	20	●	107,2	43,5	●	132,2	68,5										1200–1249		
12,5	2,3			SMDH 125 □ □	●	91	25,5	20	●	107,3	43,5	●	132,3	68,5											1250–1299	
13,0	2,4			SMDH 130 □ □	●	92	27,5	20	●	112,4	46,5	●	142,4	73,5											1300–1349	
14,0	2,5			SMDH 140 □ □ □	●	96	31,5	20	●	119,0	52,5	●	149,0	81,5	●	194,0	124,5	●	238,5	168,5	20					1350–1450
15,0	2,7	20	50	SMDH 150 □ □ □	●	100	32,0	25	●	129,2	55,0	●	159,2	86,0	●	204,2	133,0	●	253,0	180,0	25				1451–1550	
16,0	2,9			SMDH 160 □ □ □	●	103	35,0	25	●	134,4	59,0	●	169,4	92,0		214,4	141,0	●	265,5	192,0	25				1551–1650	
17,0	3,1			SMDH 170 □ □ □	●	105	35,5	25	●	139,6	62,5	●	174,6	97,5	●	224,6	150,5	●	278,1	203,5	25				1651–1750	
18,0	3,3			SMDH 180 □ □ □	●	107	39,7	25	●	144,8	66,5	●	179,8	103,5	●	229,8	158,5	●	290,5	215,5	25					1751–1850
19,0	3,5	25	56	SMDH 190 □ □ □		115	40,5	30	●	160,1	69,5	●	195,0	108,5	●	255,0	167,5	●	309,1	228,5	30				1851–1950	
20,0	3,6			SMDH 200 □ □ □	●	118	43,0	30	●	160,1	73,0	●	200,1	114,0	●	265,1	175,0	●	321,4	240,0	30				1951–2050	
21,0	3,8			SMDH 210 □ □ □	●	119	44,0	30	●	160,3	76,0	●	200,3	119,0	●	270,3	184,0	●	333,9	252,0	30				2051–2150	
22,0	4,0			SMDH 220 □ □ □	●	121	47,0	30	●	165,1	80,0	●	205,1	125,0	●	275,1	192,0	●	347,0	264,0	30					2151–2280
23,0	4,2	32	60	SMDH 230 □ □ □	●	122	46,5	30	●	164,8	82,5	●	214,8	129,5	●	284,8	200,5	●	359,0	275,5	30				2281–2380	
24,0	4,4			SMDH 240 □ □ □	●	129	49,5	37	●	174,6	86,5	●	224,6	135,5	●	299,6	208,5	●	376,1	284,5	37					2381–2480
25,0	4,6			SMDH 250 □ □ □	●	129	49,0	37	●	174,6	88,0	●	229,6	140,0	●	304,6	217,0	●	388,4	300,0	37					2481–2580
26,0	4,7			SMDH 260 □ □ □	●	132	52,0	37	●	179,7	92,0	●	234,7	146,0	●	314,7	225,0									2581–2680
27,0	4,9	32	60	SMDH 270 □ □ □	●	133	53,0	37	●	179,9	94,0	●	239,9	151,0	●	324,9	234,0									2681–2780
28,0	5,1			SMDH 280 □ □ □	●	135	54,5	37	●	185,1	96,5	●	245,1	156,5	●	330,1	241,5									2781–2880
29,0	5,3			SMDH 290 □ □ □	●	136	55,5	37	●	190,3	99,5	●	250,3	161,5	●	340,3	250,5									2881–2980
30,0	5,5			SMDH 300 □ □ □	●	139	58,5	37	●	190,5	104,5	●	260,5	167,5	●	350,5	259,5									2981–3050

Drill order description example: SMDH210M3, drill heads ⇨ K59/H60

### ■ Recommended Torque

Screw		Applicable Insert
	(N·m)	
BXD 02208 IP	0,8–1,0	SMDT 1200 – 1550 D M □ L
BXD 02509 IP	0,9–1,2	SMDT 1551 – 1850 D M □ L
BXD 03011 IP	1,8–2,4	SMDT 1851 – 2150 D M □ L
BXD 03512 IP	2,8–3,7	SMDT 2151 – 2480 D M □ L
BXD 04014 IP	4,1–5,5	SMDT 2481 – 2780 D M □ L
BXD 04515 IP	5,0–6,6	SMDT 2781 – 3050 D M □ L

### ■ Spare Parts

Screw	Wrench	Applicable Holder
BXD 02208 IP	TRDR 08 IP	SMDT 120 – 150 M □
BXD 02509 IP	TRDR 10 IP	SMDT 160 – 180 M □
BXD 03011 IP	TRDR 15 IP	SMDT 190 – 210 M □
BXD 03512 IP	TRDR 15 IP	SMDT 220 – 240 M □
BXD 04014 IP	TRDR 20 IP	SMDT 250 – 270 M □
BXD 04515 IP	TRDR 25 IP	SMDT 280 – 300 M □



● = Euro stock

Recommended Tightening Torque (N·m)

PVD coated grade: **ACX70**

Type MTL

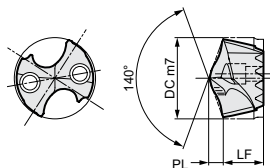

## ■ Drill Head (Insert)

### ● Ø 12,0–15,3 mm

DC (mm)	Cat. No.	Stock	PL	LF
12,0	SMDT 1200 D MTL	●	2,2	6,9
12,1	1210 D MTL	●	2,2	
12,2	1220 D MTL	●	2,2	
12,3	1230 D MTL	●	2,2	
12,4	1240 D MTL	●	2,3	
12,5	SMDT 1250 D MTL	●	2,3	7,1
12,6	1260 D MTL	●	2,3	
12,7	1270 D MTL	●	2,3	
12,8	1280 D MTL	●	2,3	
12,9	1290 D MTL	●	2,3	
13,0	SMDT 1300 D MTL	●	2,4	7,3
13,1	1310 D MTL	●	2,4	
13,2	1320 D MTL	●	2,4	
13,3	1330 D MTL	●	2,4	
13,4	1340 D MTL	●	2,4	
13,5	SMDT 1350 D MTL	●	2,5	7,8
13,6	1360 D MTL	●	2,5	
13,7	1370 D MTL	●	2,5	
13,8	1380 D MTL	●	2,5	
13,9	1390 D MTL	●	2,5	
14,0	1400 D MTL	●	2,5	
14,1	1410 D MTL	●	2,6	
14,2	1420 D MTL	●	2,6	
14,3	1430 D MTL	●	2,6	
14,4	1440 D MTL	●	2,6	
14,5	1450 D MTL	●	2,6	
14,6	SMDT 1460 D MTL	●	2,7	8,3
14,7	1470 D MTL	●	2,7	
14,8	1480 D MTL	●	2,7	
14,9	1490 D MTL	●	2,7	
15,0	1500 D MTL	●	2,7	
15,1	1510 D MTL	●	2,7	
15,2	1520 D MTL	●	2,8	
15,3	1530 D MTL	●	2,8	

### ● Ø 15,4–18,7 mm

DC (mm)	Cat. No.	Stock	PL	LF
15,4	SMDT 1540 D MTL	●	2,8	8,3
15,5	1550 D MTL	●	2,8	
15,6	SMDT 1560 D MTL	●	2,8	8,7
15,7	1570 D MTL	●	2,9	
15,8	1580 D MTL	●	2,9	
15,9	1590 D MTL	●	2,9	
16,0	1600 D MTL	●	2,9	
16,1	1610 D MTL	●	2,9	
16,2	1620 D MTL	●	2,9	
16,3	1630 D MTL	●	3,0	
16,4	1640 D MTL	●	3,0	
16,5	1650 D MTL	●	3,0	
16,6	SMDT 1660 D MTL	●	3,0	9,2
16,7	1670 D MTL	●	3,0	
16,8	1680 D MTL	●	3,1	
16,9	1690 D MTL	●	3,1	
17,0	1700 D MTL	●	3,1	
17,1	1710 D MTL	●	3,1	
17,2	1720 D MTL	●	3,1	
17,3	1730 D MTL	●	3,1	
17,4	1740 D MTL	●	3,2	
17,5	1750 D MTL	●	3,2	
17,6	SMDT 1760 D MTL	●	3,2	9,6
17,7	1770 D MTL	●	3,2	
17,8	1780 D MTL	●	3,2	
17,9	1790 D MTL	●	3,3	
18,0	1800 D MTL	●	3,3	
18,1	1810 D MTL	●	3,3	
18,2	1820 D MTL	●	3,3	
18,3	1830 D MTL	●	3,3	
18,4	1840 D MTL	●	3,3	
18,5	1850 D MTL	●	3,4	
18,6	SMDT 1860 D MTL	●	3,4	10,1
18,7	1870 D MTL	●	3,4	

### ● Ø 18,8–30,5 mm

DC (mm)	Cat. No.	Stock	PL	LF		
18,8	SMDT 1880 D MTL	●	3,4	10,1		
18,9	1890 D MTL	●	3,4			
19,0	1900 D MTL	●	3,5			
19,1	1910 D MTL	●	3,5			
19,2	1920 D MTL	●	3,5			
19,3	1930 D MTL	●	3,5			
19,4	1940 D MTL	●	3,5			
19,5	1950 D MTL	●	3,5			
19,6	SMDT 1960 D MTL	●	3,6		10,5	
19,7	1970 D MTL	●	3,6			
19,8	1980 D MTL	●	3,6			
19,9	1990 D MTL	●	3,6			
20,0	2000 D MTL	●	3,6			
20,5	SMDT 2050 D MTL	●	3,7	11,0		
21,0	SMDT 2100 D MTL	●	3,8			
21,5	2150 D MTL	●	3,9			
22,0	SMDT 2200 D MTL	●	4,0			
22,5	2250 D MTL	●	4,1			
23,0	SMDT 2300 D MTL	●	4,2		11,0	
23,5	2350 D MTL	●	4,3			
24,0	SMDT 2400 D MTL	●	4,4			
24,5	2450 D MTL	●	4,5			
25,0	SMDT 2500 D MTL	●	4,5			11,3
25,5	2550 D MTL	●	4,6			
26,0	SMDT 2600 D MTL	●	4,7			
26,5	2650 D MTL	●	4,8			
27,0	SMDT 2700 D MTL	●	4,9	12,2		
27,5	2750 D MTL	●	5,0			
28,0	SMDT 2800 D MTL	●	5,1			
28,5	2850 D MTL	●	5,2			
29,0	SMDT 2900 D MTL	●	5,3		13,1	
29,5	2950 D MTL	●	5,4			
30,0	SMDT 3000 D MTL	●	5,5			
30,5	3050 D MTL	●	5,6			

## ■ Recommended Cutting Conditions

### ● For using 3 x D and 5 x D type drills

Work material Drill Ø (mm)		General steel (HB250–320)	Harden steel (HRC45)	Nodular cast iron
		~ 16,0	<b>v<sub>c</sub></b>	70 – 100 – 120
	<b>f</b>	0,15 – 0,2 – 0,3	0,1 – 0,15 – 0,2	0,2 – 0,25 – 0,3
~ 20,0	<b>v<sub>c</sub></b>	70 – 100 – 120	40 – 70 – 90	50 – 70 – 90
	<b>f</b>	0,15 – 0,25 – 0,35	0,15 – 0,2 – 0,25	0,2 – 0,25 – 0,35
~ 30,8	<b>v<sub>c</sub></b>	70 – 100 – 120	40 – 60 – 90	50 – 70 – 90
	<b>f</b>	0,2 – 0,25 – 0,35	0,15 – 0,2 – 0,25	0,25 – 0,3 – 0,35

Note: High cutting performance is enhanced when using a high quality machine and rigid set up.

### ● For using 8 x D and 12 x D type drills

Work material Drill Ø (mm)		General steel (HB250–320)	Harden steel (HRC45)	Nodular cast iron
		~ 16,0	<b>v<sub>c</sub></b>	50 – 70 – 80
	<b>f</b>	0,15 – 0,2 – 0,3	0,1 – 0,15 – 0,2	0,2 – 0,25 – 0,3
~ 20,0	<b>v<sub>c</sub></b>	50 – 70 – 80	30 – 50 – 70	40 – 60 – 80
	<b>f</b>	0,15 – 0,25 – 0,35	0,15 – 0,2 – 0,25	0,2 – 0,25 – 0,35
~ 25,0 (12D)	<b>v<sub>c</sub></b>	50 – 70 – 80	30 – 50 – 70	40 – 60 – 80
~ 30,5 (8D)	<b>f</b>	0,2 – 0,25 – 0,35	0,15 – 0,2 – 0,25	0,25 – 0,3 – 0,35

[ v<sub>c</sub> : Cutting Speed (m/min), f : Feed rate (mm/rev), Min - Optimum - Max ]



# Regrindable Drill Head Insert SMDT... D MEL Type

MEL Type for Smooth Cutting

(Soft Steel, Stainless Steel, Grey Cast Iron)

PVD coated grade: **ACX80**

Type MEL

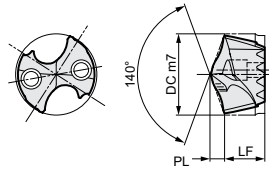

## ■ Drill Head (Insert)

### ● Ø 12,0–15,3 mm

DC (mm)	Cat. No.	Stock	PL	LF
12,0	SMDT 1200 D MEL	●	2,2	6,9
12,1	1210 D MEL	●	2,2	
12,2	1220 D MEL	●	2,2	
12,3	1230 D MEL	●	2,2	
12,4	1240 D MEL	●	2,3	
12,5	SMDT 1250 D MEL	●	2,3	7,1
12,6	1260 D MEL	●	2,3	
12,7	1270 D MEL	●	2,3	
12,8	1280 D MEL	●	2,3	
12,9	1290 D MEL	●	2,3	
13,0	SMDT 1300 D MEL	●	2,4	7,3
13,1	1310 D MEL	●	2,4	
13,2	1320 D MEL	●	2,4	
13,3	1330 D MEL	●	2,4	
13,4	1340 D MEL	●	2,4	
13,5	SMDT 1350 D MEL	●	2,5	7,8
13,6	1360 D MEL	●	2,5	
13,7	1370 D MEL	●	2,5	
13,8	1380 D MEL	●	2,5	
13,9	1390 D MEL	●	2,5	
14,0	1400 D MEL	●	2,5	
14,1	1410 D MEL	●	2,6	
14,2	1420 D MEL	●	2,6	
14,3	1430 D MEL	●	2,6	
14,4	1440 D MEL	●	2,6	
14,5	1450 D MEL	●	2,6	
14,6	SMDT 1460 D MEL	●	2,7	8,3
14,7	1470 D MEL	●	2,7	
14,8	1480 D MEL	●	2,7	
14,9	1490 D MEL	●	2,7	
15,0	1500 D MEL	●	2,7	
15,1	1510 D MEL	●	2,7	
15,2	1520 D MEL	●	2,8	
15,3	1530 D MEL	●	2,8	

### ● Ø 15,4–18,7 mm

DC (mm)	Cat. No.	Stock	PL	LF
15,4	SMDT 1540 D MEL	●	2,8	8,3
15,5	1550 D MEL	●	2,8	
15,6	SMDT 1560 D MEL	●	2,8	
15,7	1570 D MEL	●	2,9	8,7
15,8	1580 D MEL	●	2,9	
15,9	1590 D MEL	●	2,9	
16,0	1600 D MEL	●	2,9	
16,1	1610 D MEL	●	2,9	
16,2	1620 D MEL	●	2,9	
16,3	1630 D MEL	●	3,0	
16,4	1640 D MEL	●	3,0	
16,5	1650 D MEL	●	3,0	
16,6	SMDT 1660 D MEL	●	3,0	
16,7	1670 D MEL	●	3,0	
16,8	1680 D MEL	●	3,1	
16,9	1690 D MEL	●	3,1	
17,0	1700 D MEL	●	3,1	
17,1	1710 D MEL	●	3,1	
17,2	1720 D MEL	●	3,1	
17,3	1730 D MEL	●	3,1	
17,4	1740 D MEL	●	3,2	
17,5	1750 D MEL	●	3,2	
17,6	SMDT 1760 D MEL	●	3,2	9,6
17,7	1770 D MEL	●	3,2	
17,8	1780 D MEL	●	3,2	
17,9	1790 D MEL	●	3,3	
18,0	1800 D MEL	●	3,3	
18,1	1810 D MEL	●	3,3	
18,2	1820 D MEL	●	3,3	
18,3	1830 D MEL	●	3,3	
18,4	1840 D MEL	●	3,3	
18,5	1850 D MEL	●	3,4	
18,6	SMDT 1860 D MEL	●	3,4	10,1
18,7	1870 D MEL	●	3,4	

### ● Ø 18,8–30,5 mm

DC (mm)	Cat. No.	Stock	PL	LF	
18,8	SMDT 1880 D MEL	●	3,4	10,1	
18,9	1890 D MEL	●	3,4		
19,0	1900 D MEL	●	3,5		
19,1	1910 D MEL	●	3,5		
19,2	1920 D MEL	●	3,5		
19,3	1930 D MEL	●	3,5		
19,4	1940 D MEL	●	3,5		
19,5	1950 D MEL	●	3,5		
19,6	SMDT 1960 D MEL	●	3,6		10,5
19,7	1970 D MEL	●	3,6		
19,8	1980 D MEL	●	3,6		
19,9	1990 D MEL	●	3,6		
20,0	2000 D MEL	●	3,6		
20,5	SMDT 2050 D MEL	●	3,7		
21,0	SMDT 2100 D MEL	●	3,8	11,0	
21,5	2150 D MEL	●	3,9		
22,0	SMDT 2200 D MEL	●	4,0	11,0	
22,5	2250 D MEL	●	4,1		
23,0	SMDT 2300 D MEL	●	4,2	11,0	
23,5	2350 D MEL	●	4,3		
24,0	SMDT 2400 D MEL	●	4,4	11,0	
24,5	2450 D MEL	●	4,5		
25,0	SMDT 2500 D MEL	●	4,5	11,3	
25,5	2550 D MEL	●	4,6		
26,0	SMDT 2600 D MEL	●	4,7	11,7	
26,5	2650 D MEL	●	4,8		
27,0	SMDT 2700 D MEL	●	4,9	12,2	
27,5	2750 D MEL	●	5,0		
28,0	SMDT 2800 D MEL	●	5,1	12,6	
28,5	2850 D MEL	●	5,2		
29,0	SMDT 2900 D MEL	●	5,3	13,1	
29,5	2950 D MEL	●	5,4		
30,0	SMDT 3000 D MEL	●	5,5	13,5	
30,5	3050 D MEL	●	5,6		

## ■ Recommended Cutting Conditions

### ● For using 3 x D and 5 x D type drills

Work material Drill Ø (mm)	Soft steel (-HB250)		Stainless steel (-HB200)		Grey cast iron	
	v <sub>c</sub>	f	v <sub>c</sub>	f	v <sub>c</sub>	f
~ 16,0	v <sub>c</sub>	80 - 100 - 120	50 - 60 - 80	50 - 70 - 90		
	f	0,15 - 0,2 - 0,35	0,1 - 0,15 - 0,2	0,2 - 0,25 - 0,3		
~ 20,0	v <sub>c</sub>	80 - 100 - 120	60 - 70 - 90	60 - 80 - 100		
	f	0,15 - 0,25 - 0,35	0,15 - 0,2 - 0,25	0,25 - 0,3 - 0,35		
~ 30,8	v <sub>c</sub>	80 - 100 - 120	60 - 70 - 90	60 - 80 - 100		
	f	0,2 - 0,3 - 0,35	0,15 - 0,2 - 0,25	0,2 - 0,35 - 0,40		

Note: High cutting performance is enhanced when using a high quality machine and rigid set up.

### ● For using 8 x D and 12 x D type drills

Work material Drill Ø (mm)	Soft steel (-HB250)		Stainless steel (-HB200)		Grey cast iron	
	v <sub>c</sub>	f	v <sub>c</sub>	f	v <sub>c</sub>	f
~ 16,0	v <sub>c</sub>	50 - 70 - 80	40 - 50 - 60	40 - 60 - 80		
	f	0,15 - 0,2 - 0,35	0,1 - 0,15 - 0,2	0,2 - 0,25 - 0,3		
~ 20,0	v <sub>c</sub>	50 - 70 - 80	40 - 60 - 70	50 - 70 - 90		
	f	0,15 - 0,25 - 0,35	0,15 - 0,2 - 0,25	0,25 - 0,3 - 0,35		
~ 25,0 (12D) ~ 30,5 (8D)	v <sub>c</sub>	60 - 70 - 80	40 - 60 - 70	50 - 70 - 90		
	f	0,2 - 0,3 - 0,35	0,15 - 0,2 - 0,25	0,2 - 0,35 - 0,4		

[ v<sub>c</sub> : Cutting Speed (m/min), f : Feed rate (mm/rev), Min - Optimum - Max ]

● = Euro stock

# Regrindable Drill Head Insert SMDT... MEL Type

## Advantages

- Replaceable and regrindable drill head
- New design decreases cutting force by 25 %
- Ideal for stainless steels - soft steels etc
- Excellent tool life when drilling cast iron
- Improves drilling performance on low powered machines
- Increases productivity



## Performance (Stainless steel machining)

### Comparison of cutting force

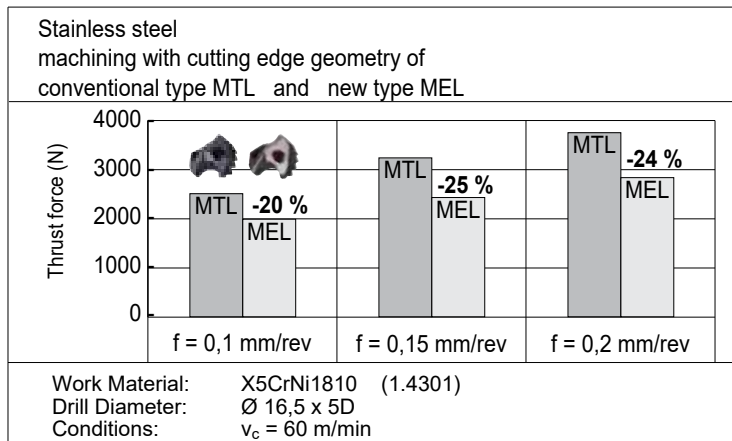

### Chip comparison

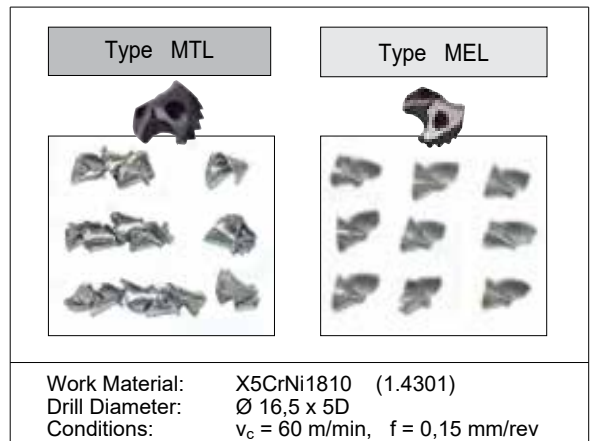

## Performance (Cast iron machining)

### Comparison of cutting force

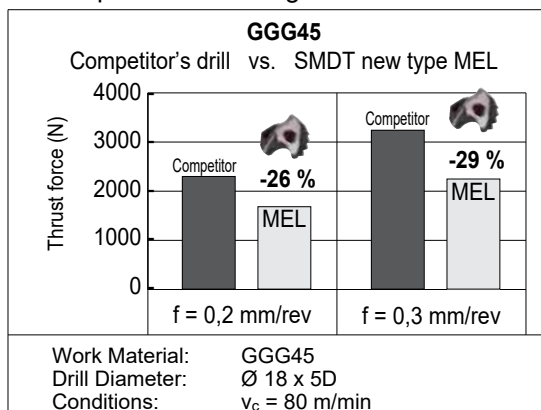

### Comparison of wear resistance

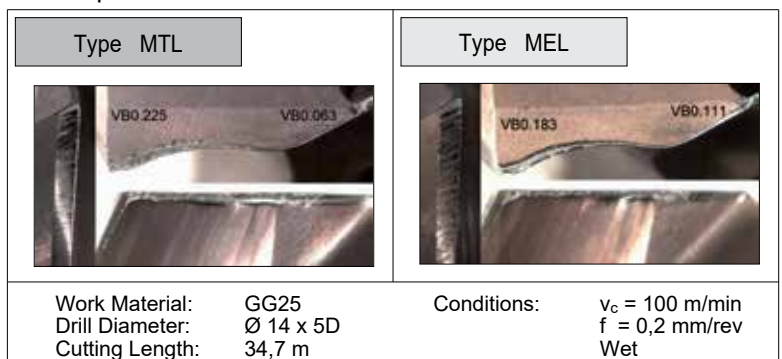

# Drill Head Insert SMDT... MFS Type

MFS Type for Drilling in Non-Flat Surfaces

## MFS Type Ideal for Drilling in Non-Flat Surfaces and Less Burr

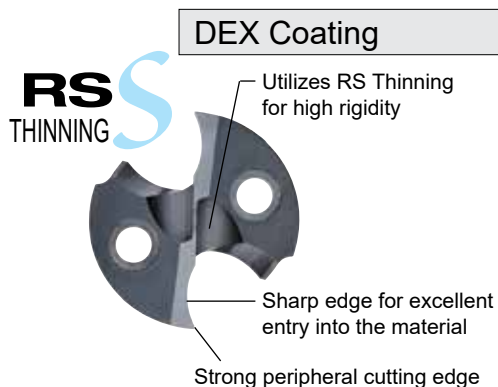

### Advantages

- Various Drilling Operations Thanks to a Point Angle of 180°**  
 Applicable to high-efficiency spot facing, drilling in non-flat surfaces such as inclined and cylindrical surfaces and interrupted drilling. Also reduces burrs at the hole exit.
- Improves Machining Stability**  
 Achieves high rigidity by employing RS Thinning, which ensures thick web at the bottom.

### Holder

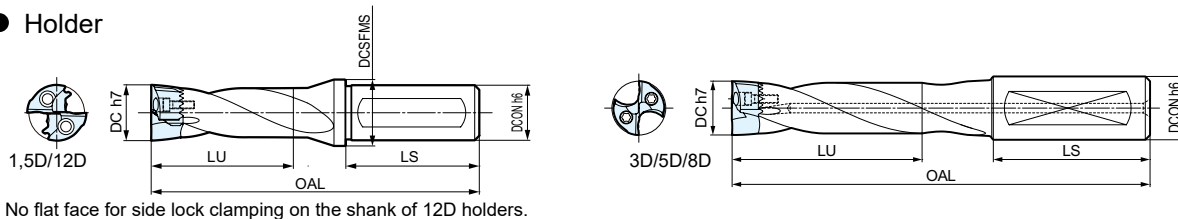

No flat face for side lock clamping on the shank of 12D holders.

### Holder

Dimensions			Cat. No.	Series (1,5D)			Series (3D)			Series (5D)			Series (8D)			Series (12D)			Related Drill Heads MFS				
Drill Head	Shank			Stock	Dimensions		Stock	Dimensions		Stock	Dimensions		Stock	Dimensions		Stock	Dimensions						
DC	DCON	LS		S	OAL	LU	DCSFMS	M3	OAL	LU	M5	OAL	LU	M8	OAL	LU	12D	OAL		LU	DCSFMS		
12,0	16	48	SMDH 120 □ □	●	91	25,5	20	●	107,2	43,5	●	132,2	68,5								1200-1249		
12,5			SMDH 125 □ □	●	91	25,5	20	●	107,3	43,5	●	132,3	68,5									1250-1299	
13,0			SMDH 130 □ □	●	92	27,5	20	●	112,4	46,5	●	142,4	73,5									1300-1349	
14,0			SMDH 140 □ □ □	●	96	31,5	20	●	119,0	52,5	●	149,0	81,5	●	194,0	124,5	●	238,5	168,5	20			1350-1450
15,0	20	50	SMDH 150 □ □ □	●	100	32,0	25	●	129,2	55,0	●	159,2	86,0	●	204,2	133,0	●	253,0	180,0	25		1451-1550	
16,0			SMDH 160 □ □ □	●	103	35,0	25	●	134,4	59,0	●	169,4	92,0	●	214,4	141,0	●	265,5	192,0	25		1551-1650	
17,0			SMDH 170 □ □ □	●	105	35,5	25	●	139,6	62,5	●	174,6	97,5	●	224,6	150,5	●	278,1	203,5	25		1651-1750	
18,0			SMDH 180 □ □ □	●	107	39,7	25	●	144,8	66,5	●	179,8	103,5	●	229,8	158,5	●	290,5	215,5	25		1751-1850	
19,0	25	56	SMDH 190 □ □ □		115	40,5	30	●	160,1	69,5	●	195,0	108,5	●	255,0	167,5	●	309,1	228,5	30		1851-1950	
20,0			SMDH 200 □ □ □	●	118	43,0	30	●	160,1	73,0	●	200,1	114,0	●	265,1	175,0	●	321,4	240,0	30		1951-2050	
21,0			SMDH 210 □ □ □	●	119	44,0	30	●	160,3	76,0	●	200,3	119,0	●	270,3	184,0	●	333,9	252,0	30		2051-2150	
22,0			SMDH 220 □ □ □	●	121	47,0	30	●	165,1	80,0	●	205,1	125,0	●	275,1	192,0	●	347,0	264,0	30		2151-2280	
23,0			SMDH 230 □ □ □	●	122	46,5	30	●	164,8	82,5	●	214,8	129,5	●	284,8	200,5	●	359,0	275,5	30		2281-2380	
24,0	32	60	SMDH 240 □ □ □	●	129	49,5	37	●	174,6	86,5	●	224,6	135,5	●	299,6	208,5	●	376,1	284,5	37		2381-2480	
25,0			SMDH 250 □ □ □	●	129	49,0	37	●	174,6	88,0	●	229,6	140,0	●	304,6	217,0	●	388,4	300,0	37		2481-2580	
26,0			SMDH 260 □ □	●	132	52,0	37	●	179,7	92,0	●	234,7	146,0	●	314,7	225,0							2581-2680
27,0			SMDH 270 □ □	●	133	53,0	37	●	179,9	94,0	●	239,9	151,0	●	324,9	234,0							2681-2780
28,0			SMDH 280 □ □	●	135	54,5	37	●	185,1	96,5	●	245,1	156,5	●	330,1	241,5							2781-2880
29,0			SMDH 290 □ □	●	136	55,5	37	●	190,3	99,5	●	250,3	161,5	●	340,3	250,5							2881-2980
30,0			SMDH 300 □ □	●	139	58,5	37	●	190,5	104,5	●	260,5	167,5	●	350,5	259,5							2981-3050

Drill order description example: SMDH210M3, drill heads ⇨ K63

### Recommended Torque

Screw		Applicable Insert
	(N·m)	
BXD 02208 IP	0,8-1,0	SMDT 1200 - 1550 MFS
BXD 02509 IP	0,9-1,2	SMDT 1551 - 1850 MFS
BXD 03011 IP	1,8-2,4	SMDT 1851 - 2150 MFS
BXD 03512 IP	2,8-3,7	SMDT 2151 - 2480 MFS
BXD 04014 IP	4,1-5,5	SMDT 2481 - 2780 MFS
BXD 04515 IP	5,0-6,6	SMDT 2781 - 3050 MFS

### Spare Parts

Screw	Wrench	Applicable Holder
BXD 02208 IP	TRDR 08 IP	SMDT 120 - 150 □ □
BXD 02509 IP	TRDR 10 IP	SMDT 160 - 180 □ □
BXD 03011 IP	TRDR 15 IP	SMDT 190 - 210 □ □
BXD 03512 IP	TRDR 15 IP	SMDT 220 - 240 □ □
BXD 04014 IP	TRDR 20 IP	SMDT 250 - 270 □ □
BXD 04515 IP	TRDR 25 IP	SMDT 280 - 300 □ □

Type MFS

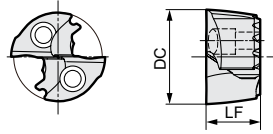

PVD coated grade: **ACX70**

### ■ Drill Head (Insert)

●  $\varnothing$  12,0 ~ 21,5 mm

DC (mm)	Cat. No.	Stock	LF (mm)	Applicable Holders
12,0	SMDT 1200 MFS	●	7,1	SMDH120 □□
12,5	SMDT 1250 MFS	●	7,2	SMDH125 □□
13,0	SMDT 1300 MFS	●	7,5	SMDH130 □□
13,5	SMDT 1350 MFS	●		
14,0	SMDT 1400 MFS	●	7,9	SMDH140 □□
14,5	SMDT 1450 MFS	●		
15,0	SMDT 1500 MFS	●	8,3	SMDH150 □□
15,5	SMDT 1550 MFS	●		
16,0	SMDT 1600 MFS	●	8,8	SMDH160 □□
16,5	SMDT 1650 MFS	●		
17,0	SMDT 1700 MFS	●	9,3	SMDH170 □□
17,5	SMDT 1750 MFS	●		
18,0	SMDT 1800 MFS	●	9,8	SMDH180 □□
18,5	SMDT 1850 MFS	●		
19,0	SMDT 1900 MFS	●	10,2	SMDH190 □□
19,5	SMDT 1950 MFS	●		
20,0	SMDT 2000 MFS	●	10,7	SMDH200 □□
20,5	SMDT 2050 MFS	●		
21,0	SMDT 2100 MFS	●	11,2	SMDH210 □□
21,5	SMDT 2150 MFS	●		

●  $\varnothing$  22,0 ~ 30,0 mm

DC (mm)	Cat. No.	Stock	LF (mm)	Applicable Holders
22,0	SMDT 2200 MFS	●	11,2	SMDH220 □□
22,5	SMDT 2250 MFS	●		
23,0	SMDT 2300 MFS	●	11,2	SMDH230 □□
23,5	SMDT 2350 MFS	●		
24,0	SMDT 2400 MFS	●	11,3	SMDH240 □□
24,5	SMDT 2450 MFS	●		
25,0	SMDT 2500 MFS	●	11,7	SMDH250 □□
25,5	SMDT 2550 MFS	●		
26,0	SMDT 2600 MFS	●	12,2	SMDH260 □□
26,5	SMDT 2650 MFS	●		
27,0	SMDT 2700 MFS	●	12,7	SMDH270 □□
27,5	SMDT 2750 MFS	●		
28,0	SMDT 2800 MFS	●	13,2	SMDH280 □□
28,5	SMDT 2850 MFS	●		
29,0	SMDT 2900 MFS	●	13,6	SMDH290 □□
29,5	SMDT 2950 MFS	●		
30,0	SMDT 3000 MFS	●	14,1	SMDH300 □□

### ■ MFS Type Head Important Notes

Application	No Guide Hole (Solid Workpiece Hole Drilling)	With Guide Hole	Flat Finishing of Hole Bottom
	<p>Flat Surface      Non-Flat Surface</p>	<p>Guide Holes</p>	
1,5D Holder	○	○ (Guide Hole not required)	○
3D-12D Holder	X	X	○

### ■ Recommended Cutting Conditions

$v_c$ : Cutting speed (m/min)  
 $f$ : Feed rate (mm/rev)

Work Material		Soft Steel (<250 HB)	General Steel (250-320HB)	Hardened Steel (45HRC)	Stainless Steel (<200 HB)	Gray Cast Iron	Ductile Cast Iron	Aluminum Alloy (*)
Drill Diameter DC (mm)	Cutting Conditions	Min.-Optimum-Max.	Min.-Optimum-Max.	Min.-Optimum-Max.	Min.-Optimum-Max.	Min.-Optimum-Max.	Min.-Optimum-Max.	Min.-Optimum-Max.
- $\varnothing$ 16,0	$v_c$	60-100-120	70-100-120	40-60-90	50-60-80	50-70-90	50-60-80	200-240-260
	$f$	0,15-0,20-0,35	0,15-0,20-0,30	0,10-0,15-0,20	0,10-0,15-0,20	0,20-0,25-0,30	0,20-0,25-0,30	0,35-0,45-0,55
- $\varnothing$ 20,0	$v_c$	80-100-120	70-100-120	40-60-90	60-70-90	60-80-100	50-70-90	200-240-260
	$f$	0,15-0,25-0,35	0,15-0,25-0,35	0,15-0,20-0,25	0,15-0,20-0,25	0,20-0,30-0,35	0,20-0,25-0,35	0,35-0,50-0,60
- $\varnothing$ 30,8	$v_c$	80-100-120	70-100-120	40-60-90	60-70-90	60-80-100	50-70-90	200-240-260
	$f$	0,20-0,30-0,35	0,20-0,25-0,35	0,15-0,20-0,25	0,15-0,20-0,25	0,20-0,30-0,40	0,25-0,30-0,35	0,35-0,50-0,60

Note: The recommended hole depth is 2 x DC. The depth is measured from the highest point of the hole when drilling on inclined surfaces. The recommended cutting conditions above are for drilling on flat horizontal surfaces. Adjust the feed rate according to the inclination angle when drilling on an inclined surface. Set the feed rate at 70 % or lower when inclination angle is 30° or less. Set the feed rate at 50 % or lower when the inclination angle is larger than 30°. This product is a drilling tool. Do not use it for traverse or helical milling.

(\*) Inquire about drills specifically for aluminum alloy.

# Replaceable Head Type MULTI-DRILLS SMD Type

Large Hole MTL Type

For Large Holes



Tool edge design ideal for malleable material used for large casings, etc.  
Edge design suitable for malleable material commonly used for large hole drilling.

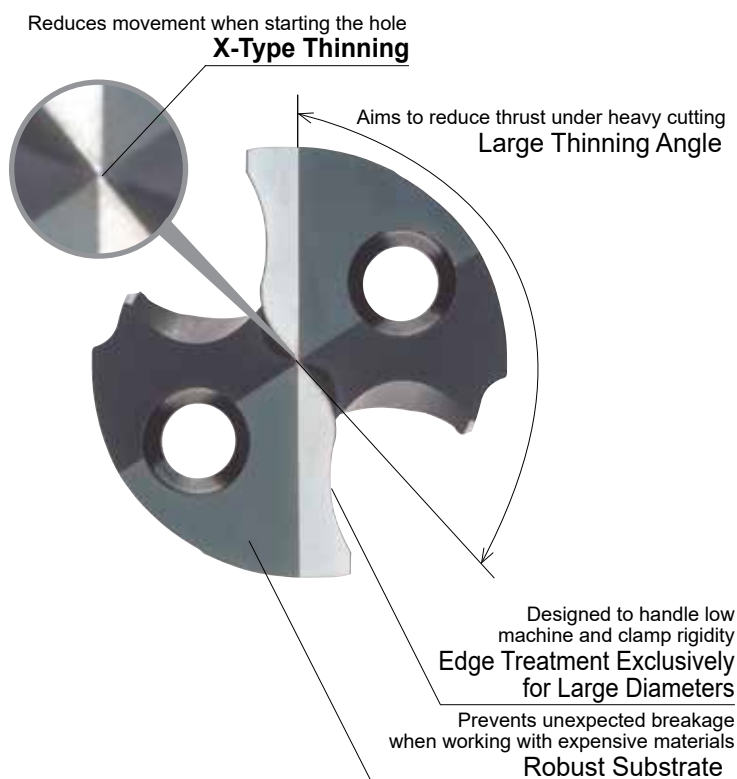
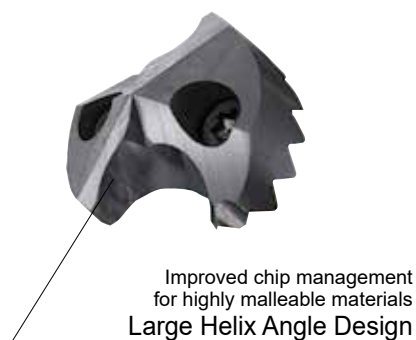

## ■ Machined Surface Accuracy

Work Material: St 52-3 (Base substrate for construction use)  
Drill Size: Ø 33,0 mm x 5D  
Cutting Conditions:  $v_c = 120$  m/min,  $f = 0,25$  mm/rev  
Cutting Environment: Emulsion Type

High drilling accuracy with large diameters

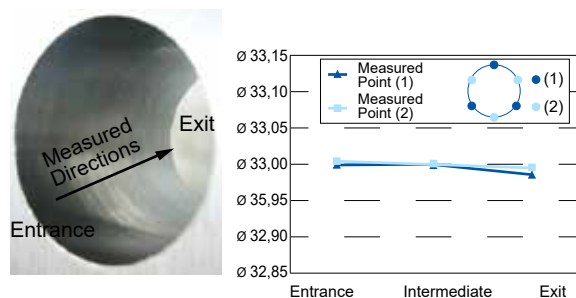

## ■ Cutting Force Comparison (Thrust)

Work Material: St 42-2 (Laminated plates)  
Drill Size: Ø 37,5 mm x 5D  
Cutting Conditions:  $v_c = 90$  m/min,  $f = 0,35$  mm/rev  
Cutting Environment: Emulsion Type

Stable even when machining laminated plates

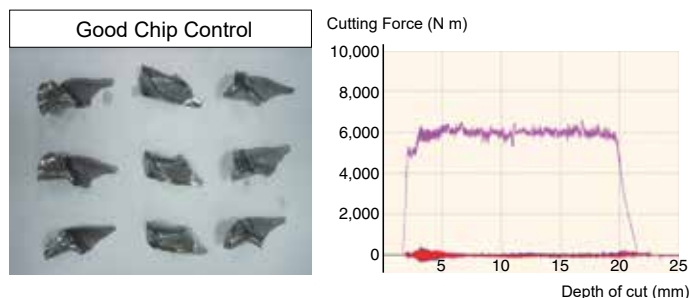

## ■ Recommended Cutting Conditions

$v_c$ =Cutting Speed (m/min)  $f$ =Feed Rate (mm/rev)

Work Material	Recommended Head Drill Ø (mm)	Cutt. Conditions	Soft Steel (-250 HB)	General Steel (250-320 HB)	Hardened Steel (45 HRC)	Stainless Steel (-200 HB)	Grey Cast Iron	Ductil Cast Iron
			MTL Type	MTL Type	MTL Type	MTL Type	MTL Type	MTL Type
-36,5		$v_c$	60-120 (40-80)	60-120 (40-80)	40-80 (30-60)	40-80 (30-60)	50-100 (40-90)	50-90 (40-70)
		$f$	0,25-0,4	0,2-0,35	0,15-0,3	0,15-0,25	0,25-0,45	0,25-0,35
-42,5		$v_c$	60-120 (40-80)	60-120 (40-80)	40-80 (30-60)	40-80 (30-60)	50-100 (40-90)	50-90 (40-70)
		$f$	0,25-0,4	0,2-0,35	0,15-0,3	0,15-0,25	0,25-0,45	0,25-0,35

Note: Where machining and work clamp rigidity are good, conditions may be increased up to the maximum.  
For 8D drills, please use feed rates stated within the ( ). Before drilling 8D holes, a guide hole of similar diameter must be made.

Multi-Drills

K50

○ = Japan stock  
□ = Delivery on request

Recommended Tightening Torque (N·m)

# Regrindable Drill Head Insert SMDT... MTL Type

For Large Holes

● Indexable Head MTL Type

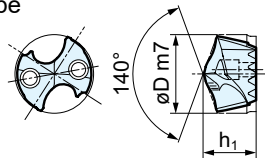

● Toolholder

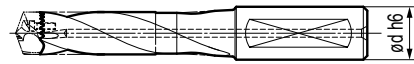

■ Drill Head ( $\varnothing$  31,0–42,5 mm), Grade MTL Type - ACX80

■ Holders M (3D), L (5D), D (8D)

Drill Diameter $\varnothing D$	Heads			Toolholder					
	MTL Type		$h_1$	M (3D)		L (5D)		D (8D)	
	Cat. No.	Stock		Cat. No.	Stock	Cat. No.	Stock	Cat. No.	Stock
31,0	SMDT 3100 MTL	☐	15,2	SMDH 320 M	○	SMDH 320 L	○	SMDH 320 D	○
31,5	SMDT 3150 MTL	☐							
32,0	SMDT 3200 MTL	○							
32,5	SMDT 3250 MTL	☐	15,2	SMDH 335 M	○	SMDH 335 L	○	SMDH 335 D	○
33,0	SMDT 3300 MTL	○							
33,5	SMDT 3350 MTL	☐							
34,0	SMDT 3400 MTL	○	16,6	SMDH 350 M	○	SMDH 350 L	○	SMDH 350 D	○
34,5	SMDT 3450 MTL	☐							
35,0	SMDT 3500 MTL	○							
35,5	SMDT 3550 MTL	☐	16,4	SMDH 365 M	○	SMDH 365 L	○	SMDH 365 D	○
36,0	SMDT 3600 MTL	○							
36,5	SMDT 3650 MTL	☐							
37,0	SMDT 3700 MTL	○	18,1	SMDH 380 M	○	SMDH 380 L	○	SMDH 380 D	○
37,5	SMDT 3750 MTL	○							
38,0	SMDT 3800 MTL	○							
38,5	SMDT 3850 MTL	☐	17,8	SMDH 395 M	○	SMDH 395 L	○	SMDH 395 D	○
39,0	SMDT 3900 MTL	○							
39,5	SMDT 3950 MTL	☐							
40,0	SMDT 4000 MTL	○	19,5	SMDH 410 M	○	SMDH 410 L	○	SMDH 410 D	○
40,5	SMDT 4050 MTL	○							
41,0	SMDT 4100 MTL	○							
41,5	SMDT 4150 MTL	☐	19,3	SMDH 425 M	○	SMDH 425 L	○	SMDH 425 D	○
42,0	SMDT 4200 MTL	○							
42,5	SMDT 4250 MTL	☐							

● Mounted Figure

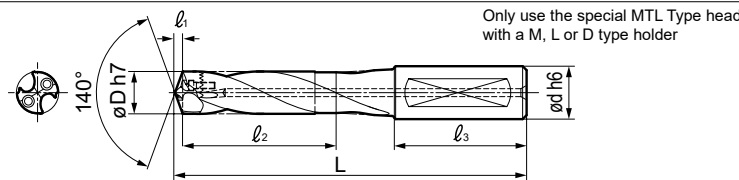

Dimensions (mm)		M (3D)		L (5D)		D (8D)		Shank		Cap Screw	Wrench	N·m
Drill Head		Dimensions (mm)		Dimensions (mm)		Dimensions (mm)		Dimensions (mm)				
$\varnothing D$	$l_1$	$l_2$	L	$l_2$	L	$l_2$	L	$l_3$	$\varnothing d$			
31,0	5,7	97,9	200,7	163	265,7	257,9	360,7	60	32,0	BXD04515IP	TRDR25IP	5–6,6
31,5												
32,0												
32,5	6,0	103,3	206,0	171,5	276,0	273,3	376,0	60	32,0	BXD04515IP	TRDR25IP	5–6,6
33,0												
33,5												
34,0	6,3	106,8	221,3	182	296,3	287	401,3	70	40,0	BX0515	HD040	7,2
34,5												
35,0												
35,5	6,6	112,3	226,6	187,5	301,6	297,3	411,6	70	40,0	BX0515	HD040	7,2
36,0												
36,5												
37,0	6,8	115,8	231,8	195,8	311,8	310,8	426,8	70	40,0	BX0515	HD040	7,2
37,5												
38,0												
38,5	7,1	121,3	237,1	206,3	322,1	321,3	437,1	70	40,0	BX0515	HD040	7,2
39,0												
39,5												
40,0	7,4	129,8	252,4	209,8	332,4	334,8	457,4	70	40,0	BX0515	HD040	7,2
40,5												
41,0												
41,5	7,6	135,3	257,6	220,3	342,6	345,3	467,6	70	40,0	BX0515	HD040	7,2
42,0												
42,5												



# SumiDrill WDX Type



## General Features

The SumiDrill WDX type has excellent cutting balance that provides stable hole drilling on a wide range of work materials from general steel to stainless steel and aluminium alloy. Available in four original chipbreaker styles, the inserts feature improved chip control and reduced cutting force for use in low rigidity contexts.

## Series Configuration

Depth of Machined Hole	Holder Diameter (mm)
2D	Ø 13,0 – Ø 68,0
3D	Ø 13,0 – Ø 68,0
4D	Ø 13,0 – Ø 63,0
5D	Ø 13,0 – Ø 55,0

## Features and Applications

### Design

Cutting force during drilling is balanced between central insert and peripheral insert. The relative position of each insert is optimised to provide stable drilling.

### Excellent Chip Control

The chip evacuation direction can be controlled with the chip control groove at the centre of the breaker, enabling good chip control.

### Versatile Tool for a Variety of Machining Applications

Select among four types of breakers for different applications, allowing optimal drilling for a variety of work materials and conditions. Suitable for a wide range of applications including hole expansion, spot facing, external turning and internal boring.

### Economical Four-Cornered Insert

Inserts can be used in either central or peripheral positions with two corners for each position - a total of four corners.

Type	L	G		H	M <span style="background-color: yellow;">New</span>
Features	For low feed with chip control	General Purpose	For non-ferrous metal drilling	Strong edge type	For stainless steel drilling
Appearance					
Figure					

**Design**  
Cutting force of central insert = that peripheral insert

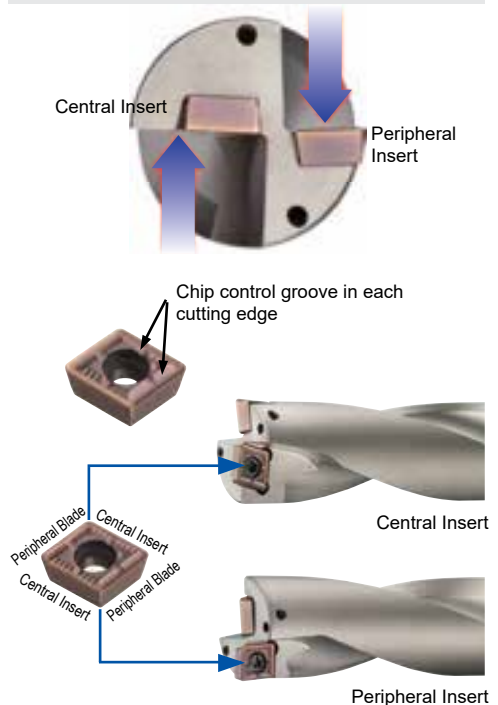

## Performance

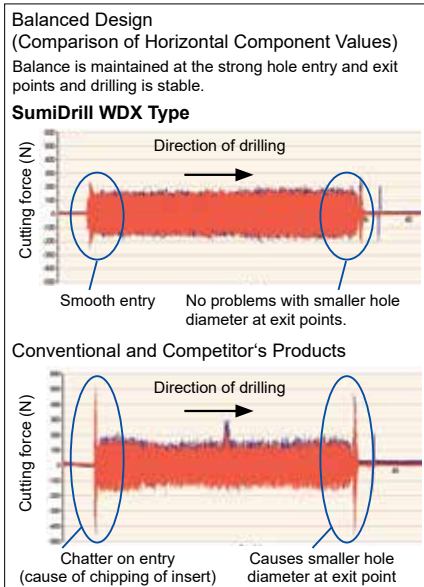

## Multi-Purpose Functionality

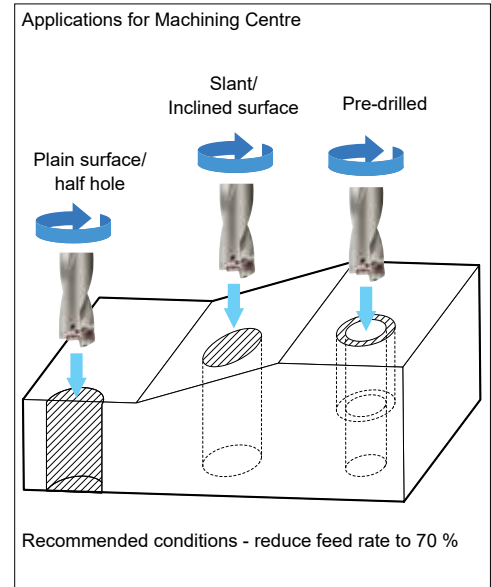

# SumiDrill WDX Type

## Chipbreaker M Type / **ACM300** New For Machining of Stainless Steel

### ■ Features

Chip control by the newly developed M chip breaker for stainless steel machining achieves stable hole quality.

Holder	WDX M Type	WDX G Type	Competitor's Product
Hole			
Chips			

Work Material: X2CrNiMo17 13 2  
Holder: WDX200D3S25  
Insert: WDXT063006 M (ACM300)  
Cutting Data:  $v_c = 150$  m/min,  $f = 0,08$  mm/rev, H = 60 mm, wet

## ACP100 For High-speed Drilling of Steel and Cast Iron

### ■ Features

Provides excellent wear resistance and high reliability thanks to our coating stress control technology and the ultra-fine crystal grain coating film of the Super FF Coat achieved through our proprietary technology.

	ACP100	Competitor's Product
Peripheral Insert	Rake Face	Rake Face
	Flank	Flank
Central Insert	Rake Face	Rake Face
	Flank	Flank

Work Material: C50  
Holder: WDX250D3S25  
Insert: WDXT063006 G (ACP100)  
Cutting Data:  $v_c = 200$  m/min,  $f = 0,12$  mm/rev, H = 50 mm through hole, wet

## Drills for Deep Hole Drilling L/D = 5

### ■ Features

The SumiDrill WDX type for 5xD drilling features a specially designed flute shape and enlarged coolant hole for excellent chip evacuation even during hole drilling.

Large coolant hole



Coolant supply guidehole

Special flute shape for L/D = 5



### ■ Performance

Characteristics	Figure	Cutting Resistance	Machined Surface (Exit)
<p><b>WDX260D5S32</b> L/D = 5</p> <p>Flutedesign</p> <p>Designed with emphasis on chip evacuation</p> <p>Expanded flute design improves chip evacuation for stable drilling performance even with holes up to 5xD.</p>		<p>Amplitude in thrust direction is larger than flutes designed for up to 4xD, but drilling performance is stable even when drilling deep holes of 5xD.</p>	<p>Produces an excellent surface finish - full hole depth</p>
<p>Comparison Tool</p> <p>Flutedesign L/D = 4</p> <p>Designed with emphasis on drill rigidity</p> <p>Flute design for greater rigidity of the drill enables stable drilling of deep holes up to 4xD.</p>		<p>However, stable drilling up to 4L/D. Chip blockage at bottom of hole.</p> <p>Strong rigidity allows only minute amplitude in the thrust direction.</p>	<p>Poor machined surface due to chip blockage at bottom of hole (near 5xD)</p>

Insert: WDXT073506-G Work Material: X5CrNiS18 10  
Cutting Data:  $v_c = 150$  m/min,  $f = 0,05$  mm/rev, H = 130 mm, through hole, wet

# SumiDrill WDX Type

## ■ Insert Selection Guide – The WDX Insert Series has a Variety of Options

5 Grades

	ACP100	ACP300	ACM300	ACK300	DL1500
<b>P</b> High-speed Drilling	○				
<b>P</b> General Drilling		○			
<b>M</b> Stainless Steel		○	○		
<b>K</b> High-speed Drilling	○				
<b>K</b> General Drilling				○	
<b>N</b> Non-ferrous Metal					○

4 Types of Chipbreakers

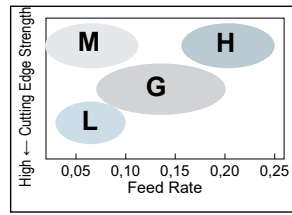

11 Combinations

	ACP100	ACP300	ACM300	ACK300	DL1500
<b>P</b> <b>K</b> <b>L</b>					
<b>P</b> <b>K</b> <b>G</b>					
<b>P</b> <b>K</b> <b>H</b>					
		<b>M</b>			

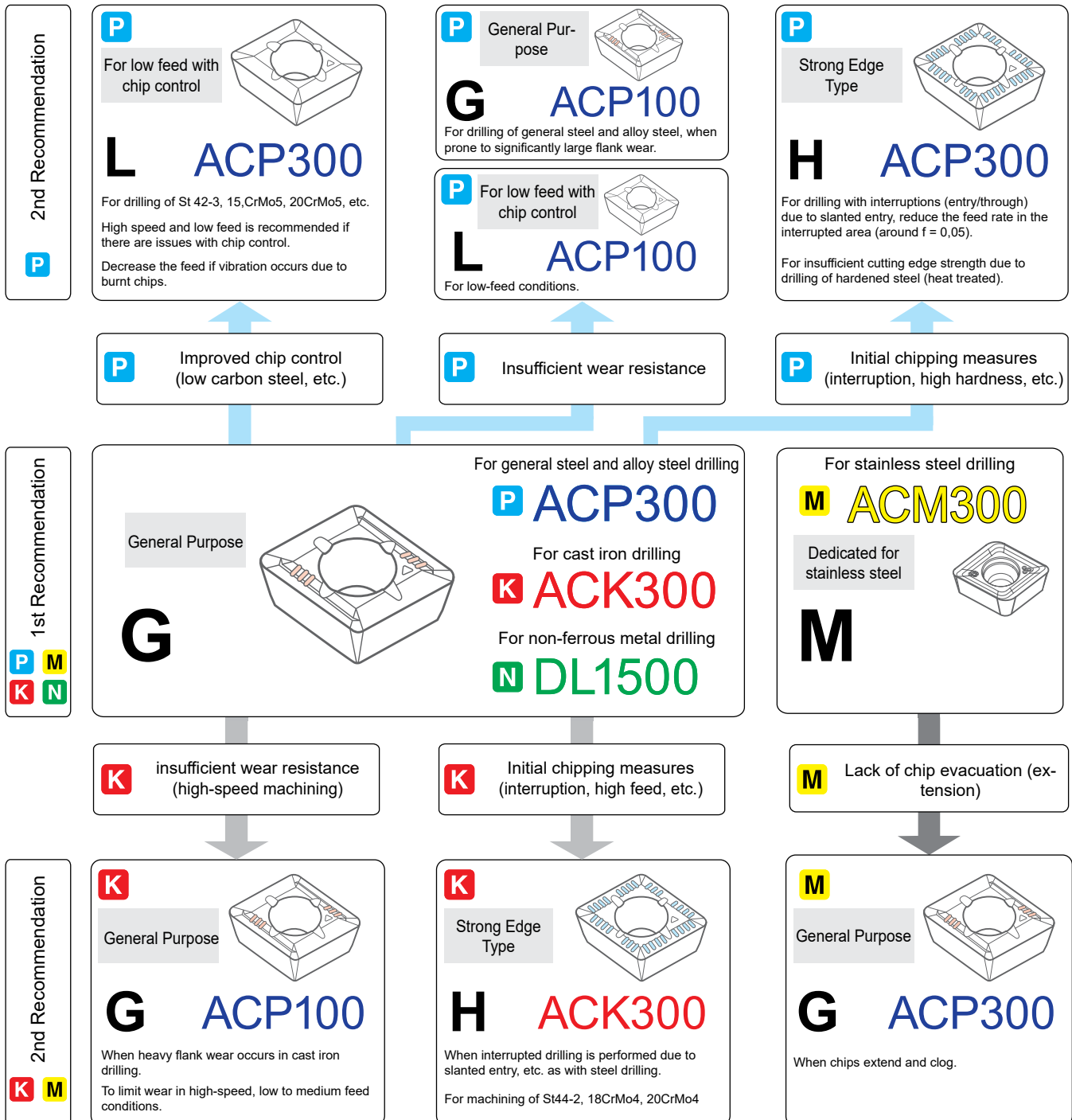

ACP100 is the first recommendation for steel with a hardness of 200HB or greater or for high-speed drilling of steel.

# SumiDrill WDX Type

## Application Examples

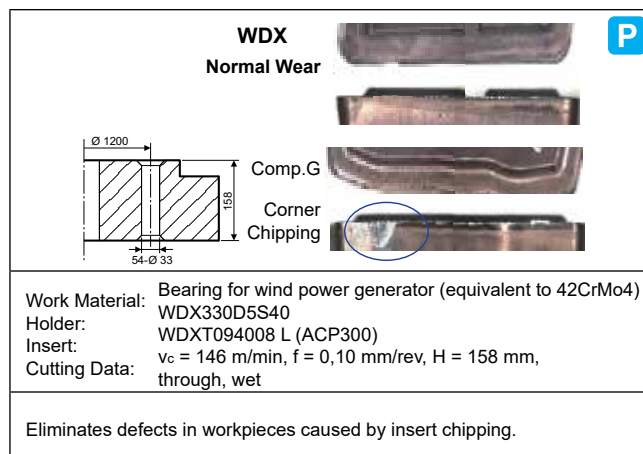
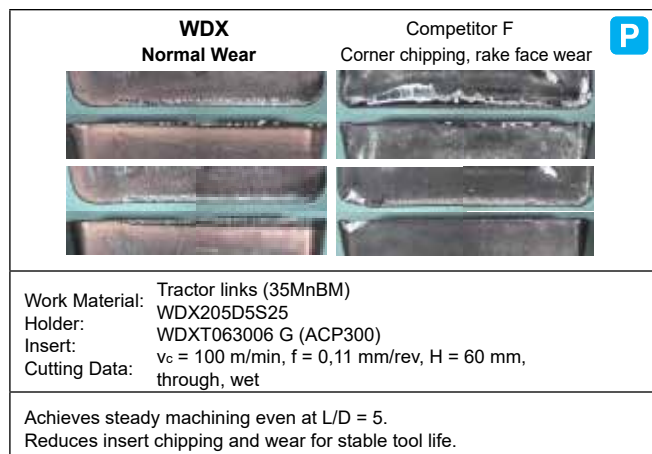
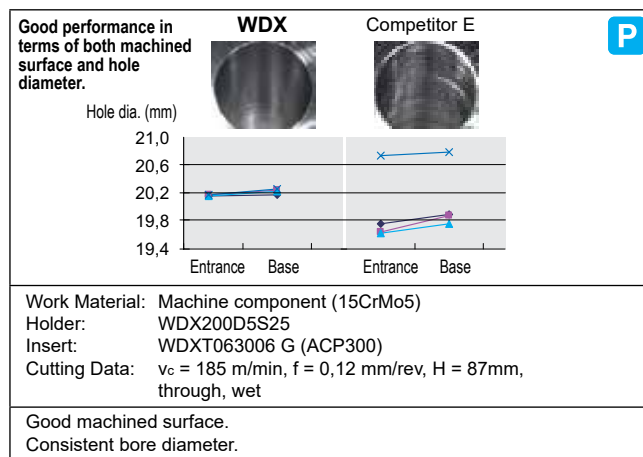
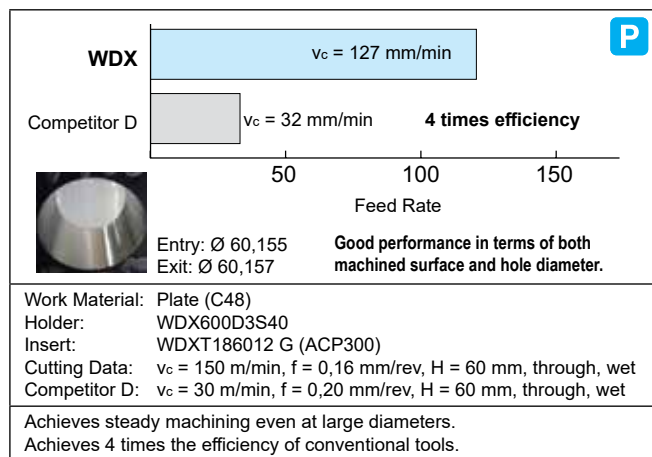
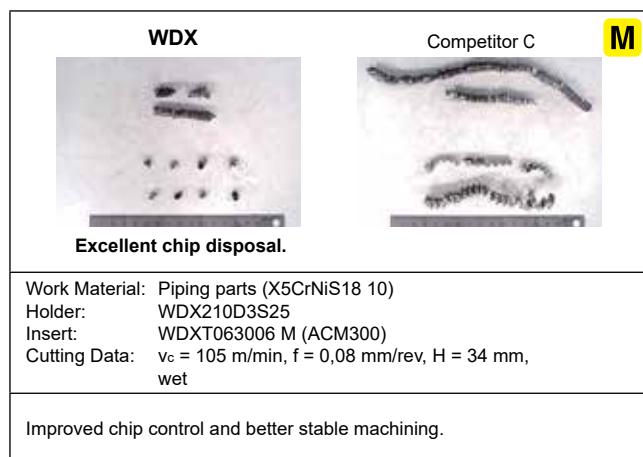
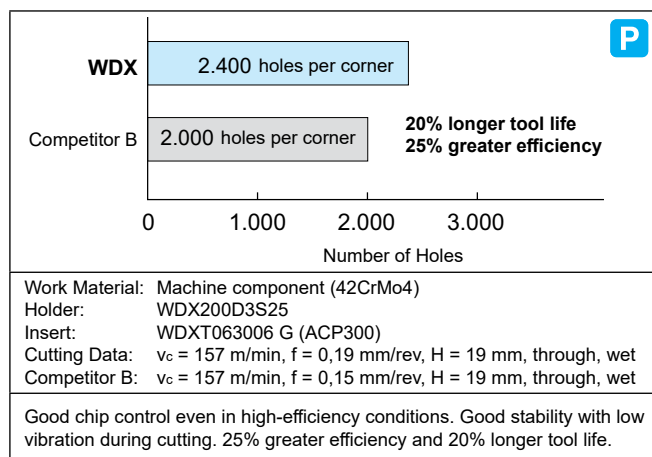
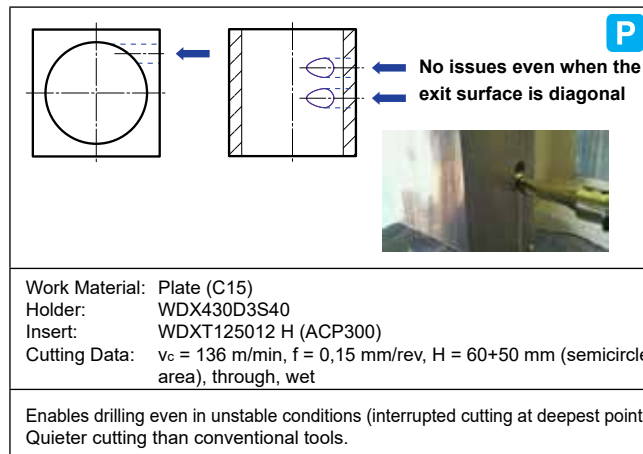
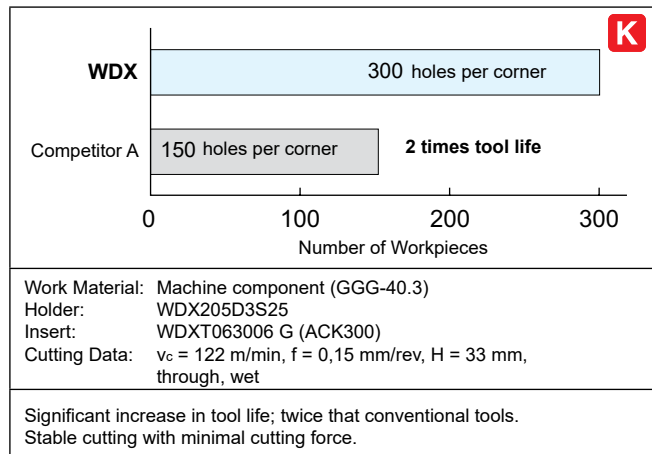



# SumiDrill WDX Type (2D)

Max. Depth: 2D

Machining tolerances -0.05 to +0.15 mm

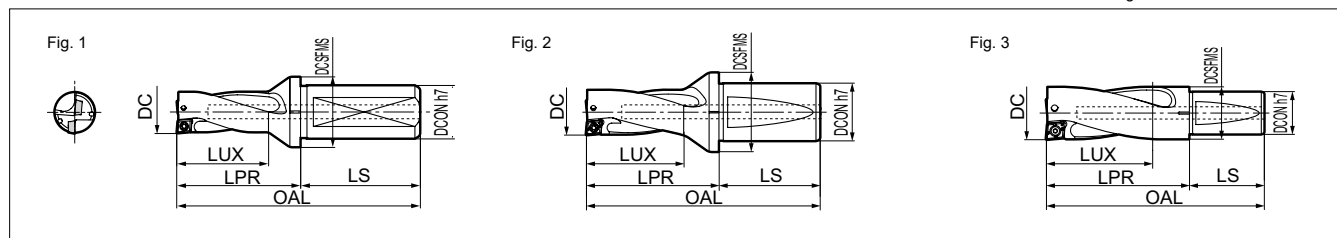

## ■ Holder Diameter Ø 13,0 mm – Ø 45,0 mm

DC	Stock	Cat. No.	LUX	LPR	OAL	LS	DCSFMS	DCON	Fig
13,0	●	WDX 130D2S20	29	44	88				1
13,5	●	135D2S20	30	45	89				1
14,0	●	140D2S20	31	46	90	44	28,0	20	1
14,5	●	145D2S20	32	47	91				1
15,0	●	150D2S20	33	48	92				1
15,5	●	WDX 155D2S20	34	49	93				1
16,0	●	160D2S20	35	50	94				1
16,5	●	165D2S20	36	51	95	44	30,0	20	1
17,0	●	170D2S20	37	52	96				1
17,5	●	WDX 175D2S25	38	53	109				1
18,0	●	180D2S25	39	54	110	56	32,0	25	1
18,5	●	WDX 185D2S25	40	55	111				1
19,0	●	190D2S25	41	56	112				1
19,5	●	195D2S25	42	57	113				1
20,0	●	200D2S25	43	58	114				1
20,5	●	205D2S25	44	59	115	56	33,0	25	1
21,0	●	210D2S25	45	60	116				1
21,5	●	215D2S25	46	61	117				1
22,0	●	220D2S25	47	62	118				1
22,5	●	225D2S25	48	63	119				1
23,0	●	WDX 230D2S25	49	67	123				1
23,5	●	235D2S25	50	68	124				1
24,0	●	240D2S25	51	69	125	56	37,0	25	1
24,5	●	245D2S25	52	70	126				1
25,0	●	250D2S25	53	71	127				1
25,5	●	WDX 255D2S32	54	74	134				2
26,0	●	260D2S32	55	75	135				2
26,5	●	265D2S32	56	76	136				2
27,0	●	270D2S32	57	77	137	60	41,0	32	2
27,5	●	275D2S32	58	78	138				2
28,0	●	280D2S32	59	79	139				2
28,5	●	285D2S32	60	80	140				2
29,0	●	WDX 290D2S32	62	83	143				2
29,5	●	295D2S32	63	84	144		50,0		2
30,0*	○	300D2S32	64	88	148	60		32	2
31,0*	○	310D2S32	66	90	150		54,0		2
32,0*	○	320D2S32	68	92	152				2
30,0*	●	WDX 300D2S40	64	88	158				2
31,0*	●	310D2S40	66	90	160				2
32,0*	●	320D2S40	68	92	162				2
33,0	●	330D2S40	70	94	164	70	54,0	40	2
34,0	●	340D2S40	72	96	166				2
35,0	●	350D2S40	74	98	168				2
36,0	●	360D2S40	76	100	170				2
37,0	●	WDX 370D2S40	79	109	179				2
38,0	●	380D2S40	81	111	181				2
39,0	●	390D2S40	83	113	183				2
40,0	●	400D2S40	85	115	185				2
41,0	●	410D2S40	87	117	187	70	49,5	40	2
42,0	●	420D2S40	89	119	189				2
43,0	●	430D2S40	91	121	191				2
44,0	●	440D2S40	93	123	193				2
45,0	●	450D2S40	95	125	195				2

\* Diameter Ø 30, Ø 31, Ø 32 are in stock with shank diameters of Ø 32 and Ø 40.

## ■ Holder Diameter Ø 46,0 mm – Ø 68,0 mm

DC	Stock	Cat. No.	LUX	LPR	OAL	LS	DCSFMS	DCON	Fig
46,0	●	WDX 460D2S40	97	127	197				2
47,0	●	470D2S40	99	129	199				2
48,0	●	480D2S40	101	131	201				2
49,0	●	490D2S40	103	133	203				2
50,0	●	500D2S40	105	135	205				2
51,0	●	510D2S40	107	137	207				3
52,0	●	520D2S40	109	139	209				3
53,0	●	530D2S40	111	141	211				3
54,0	●	540D2S40	113	143	213				3
55,0	●	550D2S40	115	145	215				3
56,0	○	WDX 560D2S40	120	152	222				3
57,0	○	570D2S40	122	154	224				3
58,0	○	580D2S40	124	156	226				3
59,0	○	590D2S40	126	158	228				3
60,0	○	600D2S40	128	160	230				3
61,0	○	610D2S40	130	162	232				3
62,0	○	620D2S40	132	164	234	70	60,0	40	3
63,0	○	630D2S40	134	166	236				3
64,0	○	640D2S40	136	168	238				3
65,0	○	650D2S40	138	170	240				3
66,0	○	660D2S40	140	172	242				3
67,0	○	670D2S40	142	174	244				3
68,0	○	680D2S40	144	176	246				3

## ■ Parts

Applicable Holder	Flat Screw		Wrench	Wrench
WDX130D2S20-WDX150D2S20	BFTX01604N	0,3	TRX06	-
WDX155D2S20-WDX180D2S25	BFTX0204N	0,5	TRX06	-
WDX185D2S25-WDX225D2S25	BFTY02206	1,0	-	TRD07
WDX230D2S25-WDX285D2S32	BFTX02506N	1,5	-	TRD08
WDX290D2S32-WDX360D2S40	BFTX03584	3,5	-	TRD15
WDX370D2S40-WDX450D2S40	BFTX0511N	5,0	-	TRD20
WDX460D2S40-WDX680D2S40	BFTX0615N	5,0	-	TRD25

## ■ Identification Details - Holder

### WDX 200 D2 S25

Diameter DC (Ø 20,0 mm) | Flute Length L/D (2D) | Shank Diameter DCON (Ø 25,0 mm)

## ■ Identification Details - Inserts

### WDX 06 30 06 -G

Width across Flats (6,0 mm) | Thickness (3,0 mm) | Breaker Type | Nose Radius (0,6 mm)

# SumiDrill WDX Type (2D)

## ■ Inserts

Application	Coated Carbide										
High-Speed / Light	<b>P</b> <sub>K</sub>				<b>N</b>						
General Purpose	<b>P</b>	<b>M</b>									
Roughing	<b>P</b>		<b>K</b>								
Cat. No.	ACP100	ACP300	ACM300	ACK300	DL1500	Fig	W1	S	RE1	RE2	Applicable Holder
WDXT 042004 L	○	●		●		1					WDX130D2S20 – WDX150D2S20
042004 G	●	●		●	●	2	4,2	2,0	0,4	0,4	
042004 H	●	●		●		3					
042004 M			●			4				0,8	
WDXT 052504 L	○	●		●		1					WDX155D2S20 – WDX180D2S25
052504 G	●	●		●	●	2	5,0	2,5	0,4	0,4	
052504 H	●	●		●		3					
052504 M			●			4				1,0	
WDXT 063006 L	●	●		●		1					WDX185D2S25 – WDX225D2S25
063006 G	●	●		●	●	2	6,0	3,0	0,6	0,6	
063006 H	●	●		●		3					
063006 M			●			4				1,4	
WDXT 073506 L	●	●		●		1					WDX230D2S25 – WDX285D2S32
073506 G	●	●		●	●	2	7,5	3,5	0,6	0,6	
073506 H	●	●		●		3					
073506 M			●			4				1,6	
WDXT 094008 L	●	●		●		1					WDX290D2S32 – WDX360D2S40
094008 G	●	●		●	●	2	9,6	4,0	0,8	0,8	
094008 H	●	●		●		3					
094008 M			●			4				2,4	
WDXT 125012 L	●	●		●		1					WDX370D2S40 – WDX450D2S40
125012 G	●	●		●	●	2	12,4	5,0	1,2	1,2	
125012 H	●	●		●		3					
125012 M			●			4				3,2	
WDXT 156012 L	●	●		●		1					WDX460D2S40 – WDX550D2S40
156012 G	●	●		●	●	2	15,2	6,0	1,2	1,2	
156012 H	●	●		●		3					
WDX- XT											WDX560D2S40 – WDX680D2S40
186012 L	●	○		○		1	18,0	6,0	1,2	1,2	
186012 G	●	●		●		2					
186012 H	○	○		○		3					

Fig. 1

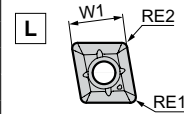

For low feed with chip control

Fig. 2

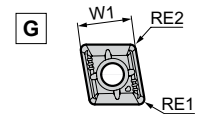

General purpose

Fig. 3

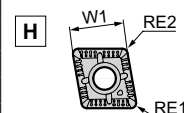

Strong edge

Fig. 4

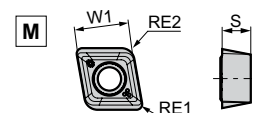

For stainless steel

## ■ Recommended Cutting Conditions (2D)

(min. - optimal - max.)

ISO	Material Group		Hardness (HB)	Chipbreaker	Grade	Cutting Speed (m/min)	Feed rate (mm/rev)				
	Work material						Ø 13,0-Ø 18,0	Ø 18,5-Ø 29,0	Ø 29,5-Ø 36,0	Ø 37,0-Ø 55,0	Ø 56,0-Ø 68,0
<b>P</b>	Carbon steel	St 42-3	125	G	ACP300	120-180-240	0,05-0,08-0,10	0,05-0,08-0,10	0,05-0,08-0,11	0,05-0,08-0,12	0,06-0,09-0,13
		C15	125	L	ACP300	130-170-220	0,04-0,08-0,12	0,04-0,08-0,12	0,04-0,08-0,13	0,05-0,10-0,15	0,06-0,11-0,17
		C45	190	G	ACP300	100-150-200	0,08-0,13-0,24	0,08-0,13-0,24	0,08-0,14-0,26	0,09-0,16-0,29	0,10-0,17-0,32
		C45 Hardened	250	G	ACP100	100-170-240	0,05-0,09-0,14	0,05-0,09-0,14	0,05-0,09-0,14	0,05-0,10-0,17	0,06-0,11-0,18
		C75 Hardened	270	G	ACP100	120-180-240	0,06-0,10-0,17	0,06-0,10-0,17	0,06-0,10-0,17	0,07-0,12-0,19	0,08-0,13-0,21
	C75 Hardened	300	G	ACP100	80-150-210	0,05-0,09-0,14	0,05-0,09-0,14	0,05-0,09-0,14	0,05-0,10-0,15	0,06-0,11-0,17	
	Low alloyed steel	Cr-Mo, Ni-Cr-Mo	180	L	ACP300	100-140-180	0,05-0,08-0,14	0,05-0,08-0,14	0,05-0,08-0,16	0,06-0,09-0,17	0,07-0,10-0,19
Low alloyed steel	Cr-Mo, Ni-Cr-Mo	Hardened	275	G	ACP100	100-170-240	0,06-0,10-0,14	0,06-0,10-0,14	0,06-0,10-0,14	0,07-0,11-0,16	0,08-0,11-0,17
			300	G	ACP100	90-150-210	0,06-0,10-0,14	0,06-0,10-0,14	0,06-0,10-0,14	0,07-0,11-0,16	0,08-0,11-0,17
			350	G	ACP100	75-120-165	0,06-0,10-0,14	0,06-0,10-0,14	0,06-0,10-0,14	0,07-0,11-0,16	0,08-0,11-0,17
High alloyed steel	Sintered	200	G	ACP100	120-180-240	0,08-0,12-0,17	0,08-0,12-0,17	0,08-0,12-0,18	0,09-0,12-0,21	0,10-0,13-0,22	
		325	G	ACP100	100-140-180	0,06-0,10-0,15	0,06-0,10-0,15	0,06-0,11-0,15	0,07-0,11-0,16	0,08-0,11-0,17	
<b>M</b>	Stainless steel	Martensitic/Ferritic	200	M	ACM300	120-150-180	0,06-0,08-0,15	0,06-0,08-0,15	0,06-0,08-0,15	0,07-0,10-0,16	0,08-0,12-0,16
		Martensitic/Hardened	240	M	ACM300	90-120-150	0,06-0,08-0,15	0,06-0,08-0,15	0,06-0,08-0,15	0,07-0,10-0,16	0,08-0,12-0,16
		Austenitic	180	M	ACM300	120-150-180	0,06-0,08-0,15	0,06-0,08-0,15	0,06-0,08-0,15	0,07-0,10-0,16	0,08-0,12-0,16
<b>K</b>	Cast iron			H	ACK300	120-160-200	0,09-0,20-0,32	0,10-0,22-0,36	0,11-0,24-0,39	0,12-0,26-0,44	0,13-0,29-0,48
		Ductile Cast iron		H	ACK300	90-120-150	0,09-0,20-0,32	0,10-0,22-0,36	0,11-0,24-0,39	0,12-0,26-0,44	0,13-0,29-0,48
<b>S</b>	Exotic Alloy (Heat resistant alloy, Super Alloy, etc)		200	G	ACP300	25-50-70	0,06-0,11-0,18	0,06-0,11-0,18	0,06-0,12-0,19	0,07-0,13-0,22	0,08-0,14-0,24
<b>N</b>	Aluminium Alloy			G	DL1500	200-260-320	0,06-0,11-0,17	0,06-0,11-0,17	0,06-0,12-0,18	0,07-0,13-0,20	0,08-0,14-0,22
	Copper Alloy			G	DL1500	180-230-280	0,06-0,11-0,17	0,06-0,11-0,17	0,06-0,12-0,18	0,07-0,13-0,20	0,08-0,14-0,22

\*For the P and K grades for which ACP300 and ACK300 are the first recommendation, ACP100 inserts are the second recommendation.  
The recommended cutting conditions are a cutting speed  $v_c$  of 130% of the above table and a feed rate  $f$  of 75%.



# SumiDrill WDX Type (3D)

Max. Depth: 3D

Machining tolerances 0 to +0.20 mm

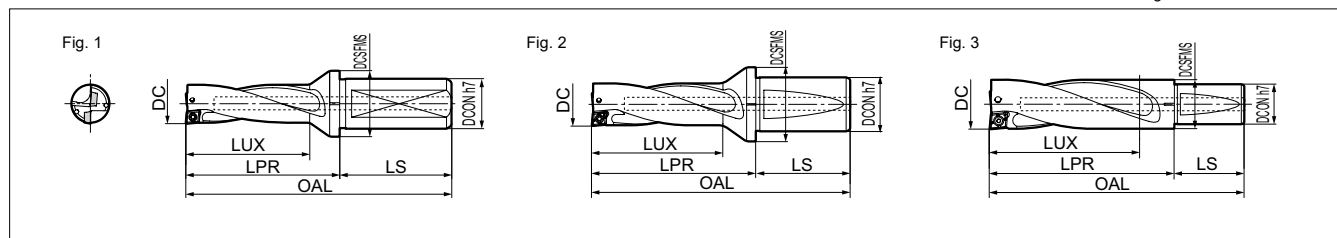

## ■ Holder Diameter Ø 13,0 mm – Ø 45,0 mm





DC	Stock	Cat. No.	LUX	LPR	OAL	LS	DCSFMS	DCON	Fig
13,0	●	WDX 130D3S20	42,0	57,0	101,0				1
13,5	●	135D3S20	43,5	58,5	102,5				1
14,0	●	140D3S20	45,0	60,0	104,0	44	28,0	20	1
14,5	●	145D3S20	46,5	61,5	105,5				1
15,0	●	150D3S20	48,0	63,0	107,0				1
15,5	●	WDX 155D3S20	49,5	64,5	108,5				1
16,0	●	160D3S20	51,0	66,0	110,0	44	30,0	20	1
16,5	●	165D3S20	52,5	67,5	111,5				1
17,0	●	170D3S20	54,0	69,0	113,0				1
17,5	●	WDX 175D3S25	55,5	70,5	126,5	56	32,0	25	1
18,0	●	180D3S25	57,0	72,0	128,0				1
18,5	●	WDX 185D3S25	58,5	73,5	129,5				1
19,0	●	190D3S25	60,0	75,0	131,0				1
19,5	●	195D3S25	61,5	76,5	132,5				1
20,0	●	200D3S25	63,0	78,0	134,0				1
20,5	●	205D3S25	64,5	79,5	135,5	56	33,0	25	1
21,0	●	210D3S25	66,0	81,0	137,0				1
21,5	●	215D3S25	67,5	82,5	138,5				1
22,0	●	220D3S25	69,0	84,0	140,0				1
22,5	●	225D3S25	70,5	85,5	141,5				1
23,0	●	WDX 230D3S25	72,0	90,0	146,0				1
23,5	●	235D3S25	73,5	91,5	147,5				1
24,0	●	240D3S25	75,0	93,0	149,0	56	37,0	25	1
24,5	●	245D3S25	76,5	94,5	150,5				1
25,0	●	250D3S25	78,0	96,0	152,0				1
25,5	●	WDX 255D3S32	79,5	99,5	159,5				2
26,0	●	260D3S32	81,0	101,0	161,0				2
26,5	●	265D3S32	82,5	102,5	162,5				2
27,0	●	270D3S32	84,0	104,0	164,0	60	41,0	32	2
27,5	●	275D3S32	85,5	105,5	165,5				2
28,0	●	280D3S32	87,0	107,0	167,0				2
28,5	●	285D3S32	88,5	108,5	168,5				2
29,0	●	WDX 290D3S32	91,0	112,0	172,0				2
29,5	●	295D3S32	92,5	113,5	173,5	50,0			2
30,0*	○	300D3S32	94,0	118,0	178,0	60		32	2
31,0*	○	310D3S32	97,0	121,0	181,0		54,0		2
32,0*	○	320D3S32	100,0	124,0	184,0				2
30,0*	●	WDX 300D3S40	94,0	118,0	188,0				2
31,0*	●	310D3S40	97,0	121,0	191,0				2
32,0*	●	320D3S40	100,0	124,0	194,0				2
33,0	●	330D3S40	103,0	127,0	197,0	70	54,0	40	2
34,0	●	340D3S40	106,0	130,0	200,0				2
35,0	●	350D3S40	109,0	133,0	203,0				2
36,0	●	360D3S40	112,0	136,0	206,0				2
37,0	●	WDX 370D3S40	116,0	146,0	216,0				2
38,0	●	380D3S40	119,0	149,0	219,0				2
39,0	●	390D3S40	122,0	152,0	222,0				2
40,0	●	400D3S40	125,0	155,0	225,0				2
41,0	●	410D3S40	128,0	158,0	228,0	70	49,5	40	2
42,0	●	420D3S40	131,0	161,0	231,0				2
43,0	●	430D3S40	134,0	164,0	234,0				2
44,0	●	440D3S40	137,0	167,0	237,0				2
45,0	●	450D3S40	140,0	170,0	240,0				2

\* Diameter Ø 30, Ø 31, Ø 32 are in stock with shank diameters of Ø 32 and Ø 40.

## ■ Holder Diameter Ø 46,0 mm – Ø 68,0 mm

DC	Stock	Cat. No.	LUX	LPR	OAL	LS	DCSFMS	DCON	Fig
46,0	●	WDX 460D3S40	143,0	173,0	243,0				2
47,0	●	470D3S40	146,0	176,0	246,0				2
48,0	●	480D3S40	149,0	179,0	249,0				2
49,0	●	490D3S40	152,0	182,0	252,0				2
50,0	●	500D3S40	155,0	185,0	255,0				2
51,0	●	510D3S40	158,0	188,0	258,0	70		40	3
52,0	●	520D3S40	161,0	191,0	261,0				3
53,0	●	530D3S40	164,0	194,0	264,0				3
54,0	●	540D3S40	167,0	197,0	267,0				3
55,0	●	550D3S40	170,0	200,0	270,0				3
56,0	○	WDX 560D3S40	176,0	208,0	278,0				3
57,0	○	570D3S40	179,0	211,0	281,0				3
58,0	○	580D3S40	182,0	214,0	284,0				3
59,0	○	590D3S40	185,0	217,0	287,0				3
60,0	○	600D3S40	188,0	220,0	290,0				3
61,0	○	610D3S40	191,0	223,0	293,0				3
62,0	○	620D3S40	194,0	226,0	296,0	70		40	3
63,0	○	630D3S40	197,0	229,0	299,0				3
64,0	○	640D3S40	200,0	232,0	302,0				3
65,0	○	650D3S40	203,0	235,0	305,0				3
66,0	○	660D3S40	206,0	238,0	308,0				3
67,0	○	670D3S40	209,0	241,0	311,0				3
68,0	○	680D3S40	212,0	244,0	314,0				3

## ■ Parts

Applicable Holder	Flat Screw		Wrench	Wrench
				
WDX130D3S20–WDX150D3S20	BFTX01604N	0,3	TRX06	–
WDX155D3S20–WDX180D3S25	BFTX0204N	0,5	TRX06	–
WDX185D3S25–WDX225D3S25	BFTY02206	1,0	–	TRD07
WDX230D3S25–WDX285D3S32	BFTX02506N	1,5	–	TRD08
WDX290D3S32–WDX360D3S40	BFTX03584	3,5	–	TRD15
WDX370D3S40–WDX450D3S40	BFTX0511N	5,0	–	TRD20
WDX460D3S40–WDX680D3S40	BFTX0615N	5,0	–	TRD25

## ■ Identification Details - Holder

### WDX 200 D3 S25

Diameter DC (Ø 20,0 mm) | Flute Length L/D (3D) | Shank Diameter DCON (Ø 25,0 mm)

## ■ Identification Details - Inserts

### WDXT 06 30 06 -G

Width across Flats (6,0 mm) | Thickness (3,0 mm) | Breaker Type | Nose Radius (0,6 mm)

# SumiDrill WDX Type (3D)

## ■ Inserts

Application	Coated Carbide										
High-Speed / Light	<b>P</b> <sub>K</sub>				<b>N</b>						
General Purpose	<b>P</b>	<b>M</b>									
Roughing	<b>P</b>		<b>K</b>								
Cat. No.	ACP100	ACP300	ACM300	ACK300	DL1500	Fig	W1	S	RE1	RE2	Applicable Holder
WDXT 042004 L	○	●		●		1					WDX130D3S20 – WDX150D3S20
042004 G	●	●		●	●	2	4,2	2,0	0,4	0,4	
042004 H	●	●		●		3					
042004 M			●			4				0,8	
WDXT 052504 L	○	●		●		1					WDX155D3S20 – WDX180D3S25
052504 G	●	●		●	●	2	5,0	2,5	0,4	0,4	
052504 H	●	●		●		3					
052504 M			●			4				1,0	
WDXT 063006 L	●	●		●		1					WDX185D3S25 – WDX225D3S25
063006 G	●	●		●	●	2	6,0	3,0	0,6	0,6	
063006 H	●	●		●		3					
063006 M			●			4				1,4	
WDXT 073506 L	●	●		●		1					WDX230D3S25 – WDX285D3S32
073506 G	●	●		●	●	2	7,5	3,5	0,6	0,6	
073506 H	●	●		●		3					
073506 M			●			4				1,6	
WDXT 094008 L	●	●		●		1					WDX290D3S32 – WDX360D3S40
094008 G	●	●		●	●	2	9,6	4,0	0,8	0,8	
094008 H	●	●		●		3					
094008 M			●			4				2,4	
WDXT 125012 L	●	●		●		1					WDX370D3S40 – WDX450D3S40
125012 G	●	●		●	●	2	12,4	5,0	1,2	1,2	
125012 H	●	●		●		3					
125012 M			●			4				3,2	
WDXT 156012 L	●	●		●		1					WDX460D3S40 – WDX550D3S40
156012 G	●	●		●	●	2	15,2	6,0	1,2	1,2	
156012 H	●	●		●		3					
WDXT 186012 L	●	○		○		1					WDX560D3S40 – WDX680D3S40
186012 G	●	●		●		2	18,0	6,0	1,2	1,2	
186012 H	○	○		○		3					

Fig. 1

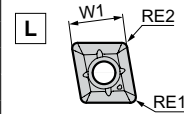

For low feed with chip control

Fig. 2

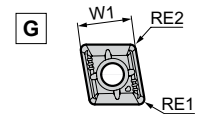

General purpose

Fig. 3

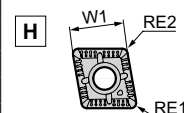

Strong edge

Fig. 4

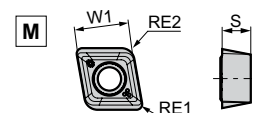

For stainless steel

## ■ Recommended Cutting Conditions (3D)

(min. - optimal - max.)

ISO	Material Group		Hardness (HB)	Chipbreaker	Grade	Cutting Speed (m/min)	Feed rate (mm/rev)				
	Work material						Ø 13,0-Ø 18,0	Ø 18,5-Ø 29,0	Ø 29,5-Ø 36,0	Ø 37,0-Ø 55,0	Ø 56,0-Ø 68,0
<b>P</b>	Carbon steel	St 42-3	125	G	ACP300	120-180-240	0,05-0,07-0,10	0,05-0,07-0,10	0,05-0,08-0,11	0,05-0,08-0,12	0,06-0,09-0,13
		C15	125	L	ACP300	130-170-220	0,04-0,07-0,10	0,04-0,07-0,10	0,04-0,08-0,11	0,05-0,09-0,12	0,06-0,10-0,13
		C45	190	G	ACP300	100-150-200	0,08-0,12-0,20	0,08-0,12-0,20	0,08-0,13-0,22	0,09-0,14-0,24	0,10-0,16-0,27
		C45 Hardened	250	G	ACP100	100-170-240	0,05-0,08-0,11	0,05-0,08-0,11	0,05-0,08-0,12	0,05-0,09-0,14	0,06-0,10-0,15
		C75	270	G	ACP100	120-180-240	0,06-0,09-0,14	0,06-0,09-0,17	0,06-0,10-0,14	0,07-0,11-0,17	0,08-0,12-0,18
	C75 Hardened	300	G	ACP100	80-150-210	0,05-0,08-0,11	0,05-0,08-0,11	0,05-0,08-0,11	0,05-0,09-0,14	0,06-0,10-0,14	
	Low alloyed steel	Cr-Mo, Ni-Cr-Mo	180	L	ACP300	100-140-180	0,05-0,07-0,12	0,05-0,07-0,12	0,05-0,08-0,13	0,06-0,08-0,13	0,07-0,09-0,16
Low alloyed steel	Cr-Mo, Ni-Cr-Mo	Hardened	275	G	ACP100	100-170-240	0,06-0,08-0,11	0,06-0,08-0,11	0,06-0,08-0,11	0,07-0,10-0,12	0,08-0,10-0,13
			300	G	ACP100	90-150-210	0,06-0,08-0,11	0,06-0,08-0,11	0,06-0,08-0,11	0,07-0,10-0,12	0,08-0,10-0,13
			350	G	ACP100	75-120-165	0,06-0,08-0,11	0,06-0,08-0,11	0,06-0,08-0,11	0,07-0,10-0,12	0,08-0,10-0,13
High alloyed steel			200	G	ACP100	120-180-240	0,08-0,11-0,14	0,08-0,12-0,15	0,08-0,12-0,16	0,09-0,14-0,18	0,10-0,14-0,19
			325	G	ACP100	100-140-180	0,06-0,09-0,11	0,06-0,09-0,11	0,06-0,09-0,11	0,07-0,10-0,12	0,08-0,10-0,13
<b>M</b>	Stainless steel	Martensitic/Ferritic	200	M	ACM300	120-150-180	0,06-0,08-0,15	0,06-0,08-0,15	0,06-0,08-0,15	0,07-0,10-0,16	0,08-0,12-0,16
		Martensitic/Hardened	240	M	ACM300	90-120-150	0,06-0,08-0,15	0,06-0,08-0,15	0,06-0,08-0,15	0,07-0,10-0,16	0,08-0,12-0,16
		Austenitic	180	M	ACM300	120-150-180	0,06-0,08-0,15	0,06-0,08-0,15	0,06-0,08-0,15	0,07-0,10-0,16	0,08-0,12-0,16
<b>K</b>	Cast iron			H	ACK300	120-160-200	0,09-0,18-0,27	0,10-0,20-0,30	0,11-0,22-0,32	0,12-0,24-0,36	0,13-0,26-0,40
						90-120-150	0,09-0,18-0,27	0,10-0,20-0,30	0,11-0,22-0,32	0,12-0,24-0,36	0,13-0,26-0,40
<b>S</b>	Exotic Alloy (Heat resistant alloy, Super Alloy, etc)		200	G	ACP300	25-50-70	0,06-0,10-0,15	0,06-0,10-0,15	0,06-0,11-0,16	0,07-0,12-0,18	0,08-0,13-0,20
<b>N</b>	Aluminium Alloy			G	DL1500	200-260-320	0,06-0,11-0,17	0,06-0,11-0,17	0,06-0,12-0,18	0,07-0,13-0,20	0,08-0,14-0,22
						180-230-280	0,06-0,11-0,17	0,06-0,11-0,17	0,06-0,12-0,18	0,07-0,13-0,20	0,08-0,14-0,22
	Copper Alloy			G	DL1500		0,06-0,11-0,17	0,06-0,11-0,17	0,06-0,12-0,18	0,07-0,13-0,20	0,08-0,14-0,22

\*For the P and K grades for which ACP300 and ACK300 are the first recommendation, ACP100 inserts are the second recommendation.  
The recommended cutting conditions are a cutting speed  $v_c$  of 130% of the above table and a feed rate  $f$  of 75%.

# SumiDrill WDX Type (4D)

Max. Depth: 4D

Machining tolerances 0 to +0.25 mm

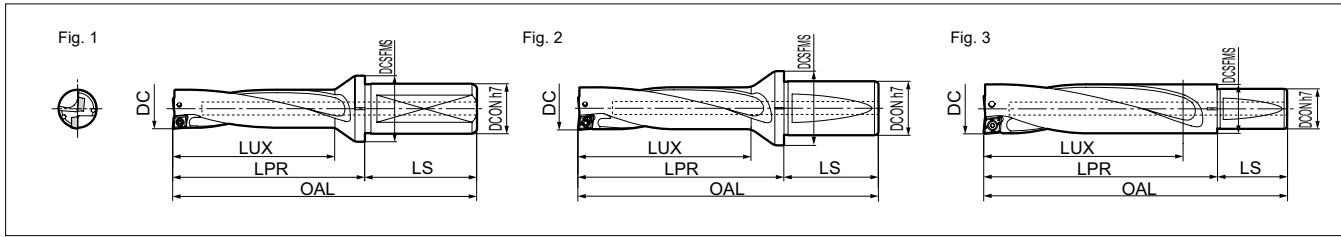

## ■ Holder Diameter Ø 13,0 mm – Ø 45,0 mm

DC	Stock	Cat. No.	LUX	LPR	OAL	LS	DCSFMS	DCON	Fig
13,0	●	WDX 130D4S20	55	70	114				1
13,5	●	135D4S20	57	72	116				1
14,0	●	140D4S20	59	74	118	44	28,0	20	1
14,5	●	145D4S20	61	76	120				1
15,0	●	150D4S20	63	78	122				1
15,5	●	WDX 155D4S20	65	80	124				1
16,0	●	160D4S20	67	82	126				1
16,5	●	165D4S20	69	84	128	44	30,0	20	1
17,0	●	170D4S20	71	86	130				1
17,5	●	WDX 175D4S25	73	88	144				1
18,0	●	180D4S25	75	90	146	56	32,0	25	1
18,5	●	WDX 185D4S25	77	92	148				1
19,0	●	190D4S25	79	94	150				1
19,5	●	195D4S25	81	96	152				1
20,0	●	200D4S25	83	98	154				1
20,5	●	205D4S25	85	100	156	56	33,0	25	1
21,0	●	210D4S25	87	102	158				1
21,5	●	215D4S25	89	104	160				1
22,0	●	220D4S25	91	106	162				1
22,5	●	225D4S25	93	108	164				1
23,0	●	WDX 230D4S25	95	113	169				1
23,5	●	235D4S25	97	115	171				1
24,0	●	240D4S25	99	117	173	56	37,0	25	1
24,5	●	245D4S25	101	119	175				1
25,0	●	250D4S25	103	121	177				1
25,5	●	WDX 255D4S32	105	125	185				2
26,0	●	260D4S32	107	127	187				2
26,5	●	265D4S32	109	129	189				2
27,0	●	270D4S32	111	131	191	60	41,0	32	2
27,5	●	275D4S32	113	133	193				2
28,0	●	280D4S32	115	135	195				2
28,5	●	285D4S32	117	137	197				2
29,0	●	WDX 290D4S32	120	141	201				2
29,5	●	295D4S32	122	143	203				2
30,0*	○	300D4S32	124	148	208	60		32	2
31,0*	○	310D4S32	128	152	212			54,0	2
32,0*	○	320D4S32	132	156	216				2
30,0*	●	WDX 300D4S40	124	148	218				2
31,0*	●	310D4S40	128	152	222				2
32,0*	●	320D4S40	132	156	226				2
33,0	●	330D4S40	136	160	230	70	54,0	40	2
34,0	●	340D4S40	140	164	234				2
35,0	●	350D4S40	144	168	238				2
36,0	●	360D4S40	148	172	242				2
37,0	●	WDX 370D4S40	153	183	253				2
38,0	●	380D4S40	157	187	257				2
39,0	●	390D4S40	161	191	261				2
40,0	●	400D4S40	165	195	265				2
41,0	●	410D4S40	169	199	269	70	49,5	40	2
42,0	●	420D4S40	173	203	273				2
43,0	●	430D4S40	177	207	277				2
44,0	●	440D4S40	181	211	281				2
45,0	●	450D4S40	185	215	285				2

\* Diameter Ø 30, Ø 31, Ø 32 are in stock with shank diameters of Ø 32 and Ø 40.

## ■ Holder Diameter Ø 46,0 mm – Ø 63,0 mm

DC	Stock	Cat. No.	LUX	LPR	OAL	LS	DCSFMS	DCON	Fig
46,0	●	WDX 460D4S40	189	219	289				2
47,0	●	470D4S40	193	223	293				2
48,0	●	480D4S40	197	227	297				2
49,0	●	490D4S40	201	231	301				2
50,0	●	500D4S40	205	235	305				2
51,0	●	510D4S40	209	239	309	70		40	3
52,0	●	520D4S40	213	243	313			50,5	3
53,0	●	530D4S40	217	247	317			51,5	3
54,0	●	540D4S40	221	251	321			52,5	3
55,0	●	550D4S40	225	255	325			53,5	3
56,0	○	WDX 560D4S40	232	264	334			54,0	3
57,0	○	570D4S40	236	268	338			55,0	3
58,0	○	580D4S40	240	272	342			56,0	3
59,0	○	590D4S40	244	276	346	70		57,0	3
60,0	○	600D4S40	248	280	350			58,0	3
61,0	○	610D4S40	252	284	354			59,0	3
62,0	○	620D4S40	256	288	358			60,0	3
63,0	○	630D4S40	260	292	362			61,0	3

## ■ Parts

Applicable Holder	Flat Screw		Wrench	Wrench
WDX130D4S20–WDX150D4S20	BFTX01604N	0,3	TRX06	–
WDX155D4S20–WDX180D4S25	BFTX0204N	0,5	TRX06	–
WDX185D4S25–WDX225D4S25	BFTY02206	1,0	–	TRD07
WDX230D4S25–WDX285D4S32	BFTX02506N	1,5	–	TRD08
WDX290D4S32–WDX360D4S40	BFTX03584	3,5	–	TRD15
WDX370D4S40–WDX450D4S40	BFTX0511N	5,0	–	TRD20
WDX460D4S40–WDX630D4S40	BFTX0615N	5,0	–	TRD25

## ■ Identification Details - Holder

### WDX 200 D4 S25

Diameter DC (Ø 20,0 mm) | Flute Length L/D (4D) | Shank Diameter DCON (Ø 25,0 mm)

## ■ Identification Details - Inserts

### WDXT 06 30 06 -G

Width across Flats (6,0 mm) | Thickness (3,0 mm) | Breaker Type | Nose Radius (0,6 mm)

# SumiDrill WDX Type (4D)

## ■ Inserts

Application	Coated Carbide										
High-Speed / Light	<b>P<sub>K</sub></b>				<b>N</b>						
General Purpose	<b>P</b>	<b>M</b>									
Roughing	<b>P</b>		<b>K</b>								
Cat. No.	ACP100	ACP300	ACM300	ACK300	DL1500	Fig	W1	S	RE1	RE2	Applicable Holder
WDXT 042004 L	○	●		●		1					WDX130D4S20 – WDX150D4S20
042004 G	●	●		●	●	2	4,2	2,0	0,4	0,4	
042004 H	●	●		●		3					
042004 M			●			4				0,8	
WDXT 052504 L	○	●		●		1					WDX155D4S20 – WDX180D4S25
052504 G	●	●		●	●	2	5,0	2,5	0,4	0,4	
052504 H	●	●		●		3					
052504 M			●			4				1,0	
WDXT 063006 L	●	●		●		1					WDX185D4S25 – WDX225D4S25
063006 G	●	●		●	●	2	6,0	3,0	0,6	0,6	
063006 H	●	●		●		3					
063006 M			●			4				1,4	
WDXT 073506 L	●	●		●		1					WDX230D4S25 – WDX285D4S32
073506 G	●	●		●	●	2	7,5	3,5	0,6	0,6	
073506 H	●	●		●		3					
073506 M			●			4				1,6	
WDXT 094008 L	●	●		●		1					WDX290D4S32 – WDX360D4S40
094008 G	●	●		●	●	2	9,6	4,0	0,8	0,8	
094008 H	●	●		●		3					
094008 M			●			4				2,4	
WDXT 125012 L	●	●		●		1					WDX370D4S40 – WDX450D4S40
125012 G	●	●		●	●	2	12,4	5,0	1,2	1,2	
125012 H	●	●		●		3					
125012 M			●			4				3,2	
WDXT 156012 L	●	●		●		1					WDX460D4S40 – WDX550D4S40
156012 G	●	●		●	●	2	15,2	6,0	1,2	1,2	
156012 H	●	●		●		3					
WDXT 186012 L	●	○		○		1					WDX560D4S40 – WDX630D4S40
186012 G	●	●		●		2	18,0	6,0	1,2	1,2	
186012 H	○	○		○		3					

Fig. 1

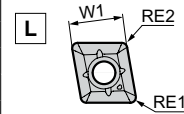

For low feed with chip control

Fig. 2

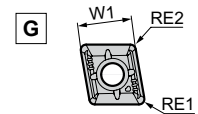

General purpose

Fig. 3

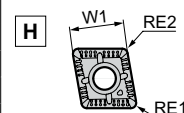

Strong edge

Fig. 4

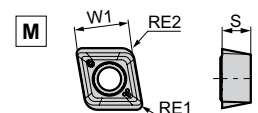

For stainless steel

## ■ Recommended Cutting Conditions (4D)

(min. - optimal - max.)

ISO	Material Group		Hardness (HB)	Chipbreaker	Grade	Cutting Speed (m/min)	Feed rate (mm/rev)				
	Work material						Ø 13,0-Ø 18,0	Ø 18,5-Ø 29,0	Ø 29,5-Ø 36,0	Ø 37,0-Ø 55,0	Ø 56,0-Ø 63,0
<b>P</b>	Carbon steel	St 42-3	125	G	ACP300	120-180-240	0,05-0,07-0,10	0,05-0,07-0,10	0,05-0,07-0,10	0,05-0,08-0,10	0,06-0,09-0,11
		C15	125	L	ACP300	130-170-220	0,04-0,07-0,09	0,04-0,07-0,09	0,04-0,07-0,09	0,05-0,08-0,10	0,06-0,09-0,11
		C45	190	G	ACP300	100-150-200	0,08-0,11-0,17	0,08-0,11-0,17	0,08-0,12-0,18	0,09-0,14-0,21	0,10-0,15-0,23
		C45 Hardened	250	G	ACP100	100-170-240	0,05-0,08-0,10	0,05-0,08-0,10	0,05-0,08-0,11	0,05-0,08-0,11	0,06-0,09-0,13
		C75	270	G	ACP100	120-180-240	0,06-0,08-0,11	0,06-0,08-0,11	0,06-0,09-0,13	0,07-0,11-0,14	0,08-0,11-0,15
	C75 Hardened	300	G	ACP100	85-150-210	0,05-0,07-0,09	0,05-0,07-0,09	0,05-0,08-0,10	0,05-0,08-0,11	0,06-0,09-0,12	
	Low alloyed steel	Cr-Mo, Ni-Cr-Mo	180	L	ACP300	100-140-180	0,05-0,07-0,10	0,05-0,07-0,10	0,05-0,07-0,11	0,06-0,08-0,12	0,07-0,09-0,14
Low alloyed steel	Cr-Mo, Ni-Cr-Mo	Hardened	275	G	ACP100	100-170-240	0,05-0,08-0,10	0,05-0,08-0,10	0,05-0,08-0,10	0,05-0,08-0,11	0,06-0,08-0,11
			350	G	ACP100	75-120-165	0,05-0,08-0,10	0,05-0,08-0,10	0,05-0,08-0,10	0,05-0,08-0,11	0,06-0,08-0,11
High alloyed steel			200	G	ACP100	120-180-240	0,06-0,10-0,13	0,07-0,11-0,14	0,07-0,11-0,15	0,08-0,12-0,16	0,09-0,13-0,17
			325	G	ACP100	100-140-180	0,05-0,08-0,10	0,05-0,08-0,10	0,05-0,08-0,10	0,05-0,08-0,11	0,06-0,08-0,11
<b>M</b>	Stainless steel	Martensitic/Ferritic	200	M	ACM300	120-150-180	0,06-0,08-0,13	0,06-0,08-0,13	0,06-0,08-0,14	0,07-0,09-0,14	0,08-0,11-0,14
		Martensitic/Hardened	240	M	ACM300	90-120-150	0,06-0,08-0,13	0,06-0,08-0,13	0,06-0,08-0,14	0,07-0,09-0,14	0,08-0,11-0,14
		Austenitic	180	M	ACM300	120-150-180	0,06-0,08-0,13	0,06-0,08-0,13	0,06-0,08-0,14	0,07-0,09-0,14	0,08-0,11-0,14
<b>K</b>	Cast iron			H	ACK300	120-160-200	0,09-0,17-0,23	0,10-0,19-0,26	0,11-0,21-0,28	0,12-0,23-0,31	0,13-0,25-0,34
						90-120-150	0,09-0,17-0,23	0,10-0,19-0,26	0,11-0,21-0,28	0,12-0,23-0,31	0,13-0,25-0,34
<b>S</b>	Exotic Alloy (Heat resistant alloy, Super Alloy, etc)		200	G	ACP300	25-50-70	0,06-0,10-0,13	0,06-0,10-0,13	0,06-0,10-0,14	0,07-0,11-0,15	0,08-0,12-0,17
<b>N</b>	Aluminium Alloy			G	DL1500	200-260-320	0,05-0,10-0,15	0,05-0,10-0,15	0,06-0,11-0,16	0,06-0,12-0,18	0,07-0,13-0,20
						180-230-280	0,05-0,10-0,15	0,05-0,10-0,15	0,06-0,11-0,16	0,06-0,12-0,18	0,07-0,13-0,20

\*For the P and K grades for which ACP300 and ACK300 are the first recommendation, ACP100 inserts are the second recommendation.  
The recommended cutting conditions are a cutting speed  $v_c$  of 130% of the above table and a feed rate  $f$  of 75%.

# SumiDrill WDX Type (5D)

Max. Depth: 5D

Machining tolerances 0 to +0.25 mm

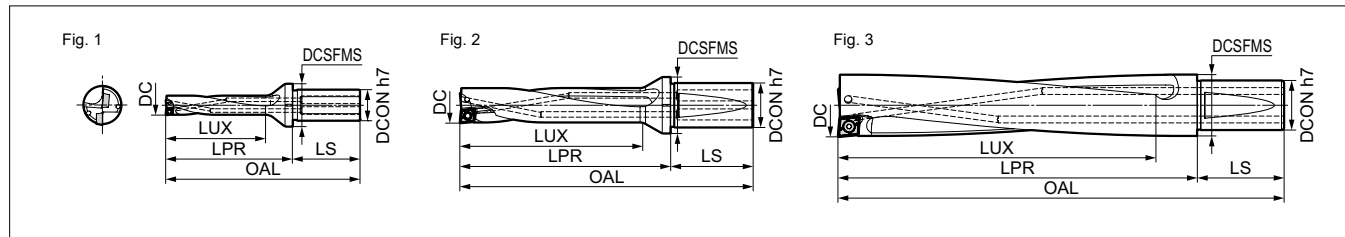

## ■ Holder Diameter Ø 13,0 mm – Ø 45,0 mm

DC	Stock	Cat. No.	LUX	LPR	OAL	LS	DCSFMS	DCON	Fig
13,0	●	WDX 130D5S20	68,0	83,0	127,0				1
13,5	●	135D5S20	70,5	85,5	129,5				1
14,0	●	140D5S20	73,0	88,0	132,0	44	28,0	20,0	1
14,5	●	145D5S20	75,5	90,5	134,5				1
15,0	●	150D5S20	78,0	93,0	137,0				1
15,5	●	WDX 155D5S20	80,5	95,5	139,5				1
16,0	●	160D5S20	83,0	98,0	142,0	44	30,0	20,0	1
16,5	●	165D5S20	85,5	100,5	144,5				1
17,0	●	170D5S20	88,0	103,0	147,0				1
17,5	●	WDX 175D5S25	90,5	105,5	161,5	56	32,0	25,0	1
18,0	●	180D5S25	93,0	108,0	164,0				1
18,5	●	WDX 185D5S25	95,5	110,5	166,5				1
19,0	●	190D5S25	98,0	113,0	169,0				1
19,5	●	195D5S25	100,5	115,5	171,5				1
20,0	●	200D5S25	103,0	118,0	174,0				1
20,5	●	205D5S25	105,5	120,5	176,5	56	33,0	25,0	1
21,0	●	210D5S25	108,0	123,0	179,0				1
21,5	●	215D5S25	110,5	125,5	181,5				1
22,0	●	220D5S25	113,0	128,0	184,0				1
22,5	●	225D5S25	115,5	130,5	186,5				1
23,0	●	WDX 230D5S25	118,0	136,0	192,0				1
23,5	●	235D5S25	120,5	138,5	194,5				1
24,0	●	240D5S25	123,0	141,0	197,0	56	37,0	25,0	1
24,5	●	245D5S25	125,5	143,5	199,5				1
25,0	●	250D5S25	128,0	146,0	202,0				1
26,0	●	WDX 260D5S32	133,0	153,0	213,0				2
27,0	●	270D5S32	138,0	158,0	218,0	60	41,0	32,0	2
28,0	●	280D5S32	143,0	163,0	223,0				2
29,0	●	WDX 290D5S32	149,0	170,0	230,0		50,0		2
30,0*	●	300D5S32	154,0	178,0	238,0	60		32,0	2
31,0*	●	310D5S32	159,0	183,0	243,0		54,0		2
32,0*	○	320D5S32	164,0	188,0	248,0				2
30,0*	●	WDX 300D5S40	154,0	178,0	248,0				2
31,0*	●	310D5S40	159,0	183,0	253,0				2
32,0*	●	320D5S40	164,0	188,0	258,0				2
33,0	●	330D5S40	169,0	193,0	263,0	70	54,0	40,0	2
34,0	●	340D5S40	174,0	198,0	268,0				2
35,0	●	350D5S40	179,0	203,0	273,0				2
36,0	●	360D5S40	184,0	208,0	278,0				2
37,0	○	WDX 370D5S40	190,0	220,0	290,0				2
38,0	○	380D5S40	195,0	225,0	295,0				2
39,0	○	390D5S40	200,0	230,0	300,0				2
40,0	○	400D5S40	205,0	235,0	305,0				2
41,0	○	410D5S40	210,0	240,0	310,0	70	49,5	40,0	2
42,0	○	420D5S40	215,0	245,0	315,0				2
43,0	○	430D5S40	220,0	250,0	320,0				2
44,0	○	440D5S40	225,0	255,0	325,0				2
45,0	○	450D5S40	230,0	260,0	330,0				2

\* Diameter Ø 30, Ø 31, Ø 32 are in stock with shank diameters of Ø 32 and Ø 40.

## ■ Holder Diameter Ø 46,0 mm – Ø 55,0 mm

DC	Stock	Cat. No.	LUX	LPR	OAL	LS	DCSFMS	DCON	Fig
46,0	○	WDX 460D5S40	235,0	265,0	335,0				2
47,0	○	470D5S40	240,0	270,0	340,0				2
48,0	○	480D5S40	245,0	275,0	345,0				2
49,0	○	490D5S40	250,0	280,0	350,0				2
50,0	○	500D5S40	255,0	285,0	355,0				2
51,0	○	510D5S40	260,0	290,0	360,0	70		40,0	3
52,0	○	520D5S40	265,0	295,0	365,0			50,5	3
53,0	○	530D5S40	270,0	300,0	370,0			51,5	3
54,0	○	540D5S40	275,0	305,0	375,0			52,5	3
55,0	○	550D5S40	280,0	310,0	380,0			53,5	3

## ■ Parts

Applicable Holder	Flat Screw	Wrench	Wrench
WDX130D5S20–WDX150D5S20	BFTX01604N	0,3	TRX06
WDX155D5S20–WDX180D5S25	BFTX0204N	0,5	TRX06
WDX185D5S25–WDX225D5S25	BFTY02206	1,0	–
WDX230D5S25–WDX280D5S32	BFTX02506N	1,5	–
WDX290D5S32–WDX360D5S40	BFTX03584	3,5	–
WDX370D5S40–WDX450D5S40	BFTX0511N	5,0	–
WDX460D5S40–WDX550D5S40	BFTX0615N	5,0	–

## ■ Identification Details - Holder

### WDX 200 D5 S25

Diameter DC (Ø 20,0 mm) | Flute Length L/D (5D) | Shank Diameter DCON (Ø 25,0 mm)

## ■ Identification Details - Inserts

### WDXT 06 30 06 -G

Width across Flats (6,0 mm) | Thickness (3,0 mm) | Breaker Type (G) | Nose Radius (0,6 mm)



# SumiDrill WDX Type (5D)

## Inserts

Application	Coated Carbide										
High-Speed / Light	<b>P<sub>K</sub></b>				<b>N</b>						
General Purpose	<b>P</b>	<b>M</b>									
Roughing	<b>P</b>		<b>K</b>								
Cat. No.	ACP100	ACP300	ACM300	ACK300	DL1500	Fig	W1	S	RE1	RE2	Applicable Holder
WDXT 042004 L	○	●		●		1					WDX130D5S20 – WDX150D5S20
042004 G	●	●		●	●	2	4,2	2,0	0,4	0,4	
042004 H	●	●		●		3					
042004 M			●			4				0,8	
WDXT 052504 L	○	●		●		1					WDX155D5S20 – WDX180D5S25
052504 G	●	●		●	●	2	5,0	2,5	0,4	0,4	
052504 H	●	●		●		3					
052504 M			●			4				1,0	
WDXT 063006 L	●	●		●		1					WDX185D5S25 – WDX225D5S25
063006 G	●	●		●	●	2	6,0	3,0	0,6	0,6	
063006 H	●	●		●		3					
063006 M			●			4				1,4	
WDXT 073506 L	●	●		●		1					WDX230D5S25 – WDX280D5S32
073506 G	●	●		●	●	2	7,5	3,5	0,6	0,6	
073506 H	●	●		●		3					
073506 M			●			4				1,6	
WDXT 094008 L	●	●		●		1					WDX290D5S32 – WDX360D5S40
094008 G	●	●		●	●	2	9,6	4,0	0,8	0,8	
094008 H	●	●		●		3					
094008 M			●			4				2,4	
WDXT 125012 L	●	●		●		1					WDX370D5S40 – WDX450D5S40
125012 G	●	●		●	●	2	12,4	5,0	1,2	1,2	
125012 H	●	●		●		3					
125012 M			●			4				3,2	
WDXT 156012 L	●	●		●		1					WDX460D5S40 – WDX550D5S40
156012 G	●	●		●	●	2	15,2	6,0	1,2	1,2	
156012 H	●	●		●		3					

Fig. 1

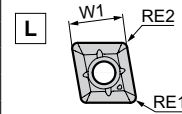

For low feed with chip control

Fig. 2

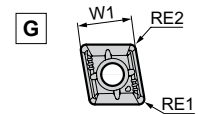

General purpose

Fig. 3

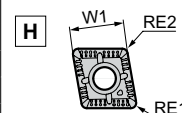

Strong edge

Fig. 4

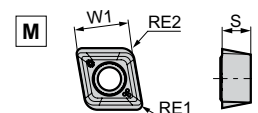

For stainless steel

## Recommended Cutting Conditions (5D)

(min. - optimal - max.)

ISO	Material Group		Hardness (HB)	Chipbreaker	Grade	Cutting Speed (m/min)	Feed rate (mm/rev)			
	Work material						Ø 13,0–Ø 18,0	Ø 18,5–Ø 29,0	Ø 29,5–Ø 36,0	Ø 37,0–Ø 55,0
<b>P</b>	Carbon steel	St 42-3	125	G	ACP300	120–180–240	0,05–0,06–0,09	0,05–0,06–0,09	0,05–0,06–0,09	0,05–0,07–0,09
		C15	125	L	ACP300	130–170–220	0,04–0,06–0,08	0,04–0,06–0,08	0,04–0,06–0,08	0,05–0,07–0,09
		C45	190	G	ACP300	100–150–200	0,07–0,10–0,15	0,07–0,10–0,15	0,08–0,11–0,17	0,09–0,12–0,19
		C45 Hardened	250	G	ACP100	100–170–240	0,04–0,07–0,08	0,04–0,07–0,08	0,05–0,07–0,09	0,05–0,08–0,11
		C75	270	G	ACP100	120–180–240	0,05–0,08–0,11	0,05–0,08–0,11	0,06–0,08–0,11	0,07–0,09–0,13
	C75 Hardened	300	G	ACP100	80–150–210	0,04–0,07–0,08	0,04–0,07–0,08	0,05–0,07–0,09	0,05–0,08–0,10	
	Low alloyed steel	Cr-Mo, Ni-Cr-Mo	180	L	ACP300	100–140–180	0,05–0,06–0,09	0,05–0,06–0,09	0,05–0,06–0,10	0,05–0,07–0,11
Low alloyed steel	Cr-Mo, Ni-Cr-Mo	Hardened	275	G	ACP100	100–170–240	0,04–0,06–0,09	0,04–0,06–0,09	0,04–0,06–0,09	0,05–0,07–0,10
			300	G	ACP100	90–150–210	0,04–0,06–0,09	0,04–0,06–0,09	0,04–0,06–0,09	0,05–0,07–0,10
			350	G	ACP100	75–120–165	0,04–0,06–0,09	0,04–0,06–0,09	0,04–0,06–0,09	0,05–0,07–0,10
High alloyed steel			200	G	ACP100	120–180–240	0,05–0,08–0,12	0,06–0,09–0,12	0,06–0,09–0,13	0,07–0,10–0,14
			325	G	ACP100	100–140–180	0,04–0,06–0,09	0,04–0,06–0,09	0,04–0,06–0,09	0,04–0,06–0,09
<b>M</b>	Stainless steel	Martensitic/Ferritic	200	M	ACM300	120–150–180	0,05–0,08–0,11	0,05–0,08–0,12	0,05–0,08–0,12	0,06–0,09–0,12
		Martensitic/Hardened	240	M	ACM300	90–120–150	0,05–0,08–0,11	0,05–0,08–0,12	0,05–0,08–0,12	0,06–0,09–0,12
		Austenitic	180	M	ACM300	120–150–180	0,05–0,08–0,11	0,05–0,08–0,12	0,05–0,08–0,12	0,06–0,09–0,12
<b>K</b>	Cast iron			H	ACK300	120–160–200	0,08–0,15–0,21	0,09–0,17–0,23	0,09–0,18–0,25	0,11–0,20–0,28
						90–120–150	0,08–0,15–0,21	0,09–0,17–0,23	0,09–0,18–0,25	0,11–0,20–0,28
<b>S</b>	Exotic Alloy (Heat resistant alloy, Super Alloy, etc)		200	G	ACP300	25–50–70	0,05–0,09–0,11	0,05–0,09–0,11	0,06–0,09–0,12	0,06–0,10–0,14
<b>N</b>	Aluminium Alloy			G	DL1500	200–260–320	0,05–0,10–0,15	0,05–0,10–0,15	0,06–0,11–0,16	0,06–0,12–0,18
						180–230–280	0,05–0,10–0,15	0,05–0,10–0,15	0,06–0,11–0,16	0,06–0,12–0,18

\*For the P and K grades for which ACP300 and ACK300 are the first recommendation, ACP100 inserts are the second recommendation. The recommended cutting conditions are a cutting speed  $v_c$  of 130% of the above table and a feed rate  $f$  of 75%.



# SumiDrill WDX Type

## ■ Hole Profile

Bottom of hole after drilling with  
**WDX200D3S25**

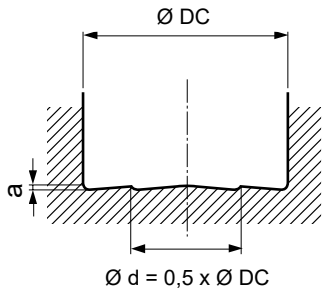

Drill Diameter DC (mm)	a (mm)
Ø 13,0– Ø 18,0	0,4
Ø 18,5– Ø 28,5	0,6
Ø 29,0– Ø 36,0	0,8
Ø 37,0– Ø 55,0	1,2
Ø 56,0– Ø 68,0	1,4

Bottom of hole after drilling with  
conventional tool

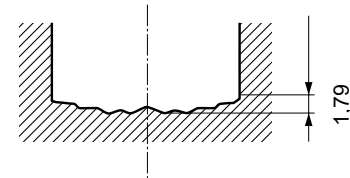

Finishing is easy because the hole bottom is almost flat.

## ■ Applications for Lathes

### Setting Instruction

Ensure the face of the drill flange is hard against the face of the tool holder.

Axis offset: Difference between workpiece axis and the Y-axis.

Align the centreline of the drill to the centreline of the lathes Y axis.

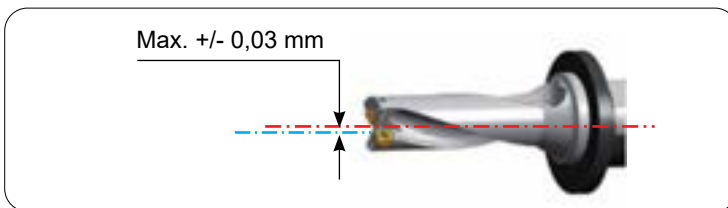

### Drilling Over Holes

Offset the lathes X axis within the maximum amount stated in the table.

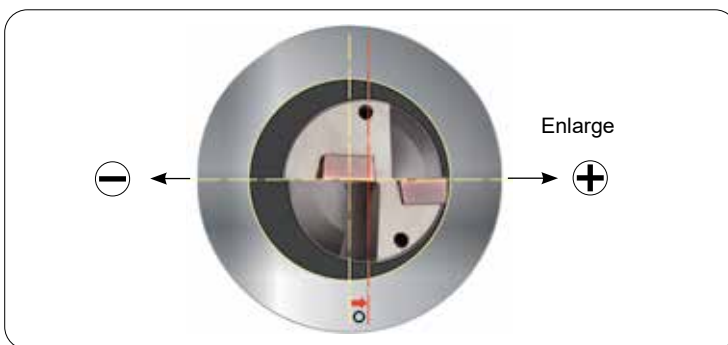

Drill	Max. Offset (mm)	Drill	Max. Offset (mm)
WDX130...	0,35	WDX330...	0,55
WDX135...	0,30	WDX340...	0,45
WDX140...	0,25	WDX350...	0,35
WDX145...	0,20	WDX360...	0,20
WDX150...	0,15	WDX370...	1,00
WDX155...	0,40	WDX380...	1,00
WDX160...	0,40	WDX390...	0,90
WDX165...	0,35	WDX400...	0,80
WDX170...	0,30	WDX410...	0,70
WDX175...	0,25	WDX420...	0,60
WDX180...	0,20	WDX430...	0,50
WDX185...	0,50	WDX440...	0,50
WDX190...	0,45	WDX450...	0,40
WDX195...	0,40	WDX460...	1,50
WDX200...	0,30	WDX470...	1,40
WDX205...	0,30	WDX480...	1,30
WDX210...	0,20	WDX490...	1,20
WDX215...	0,15	WDX500...	1,10
WDX220...	0,10	WDX510...	1,00
WDX225...	0,05	WDX520...	0,90
WDX230...	0,70	WDX530...	0,80
WDX235...	0,70	WDX540...	0,60
WDX240...	0,60	WDX550...	0,50
WDX245...	0,50	WDX560...	2,00
WDX250...	0,50	WDX570...	1,80
WDX255...	0,45	WDX580...	1,70
WDX260...	0,40	WDX590...	1,60
WDX265...	0,35	WDX600...	1,50
WDX270...	0,25	WDX610...	1,40
WDX275...	0,20	WDX620...	1,30
WDX280...	0,15	WDX630...	1,20
WDX285...	0,10	WDX640...	1,00
WDX290...	1,00	WDX650...	0,90
WDX295...	0,95	WDX660...	0,70
WDX300...	0,90	WDX670...	0,60
WDX310...	0,80	WDX680...	0,50
WDX320...	0,70		

Recommended conditions - reduce feed rate to 30 %

## ■ Turning by Lathes

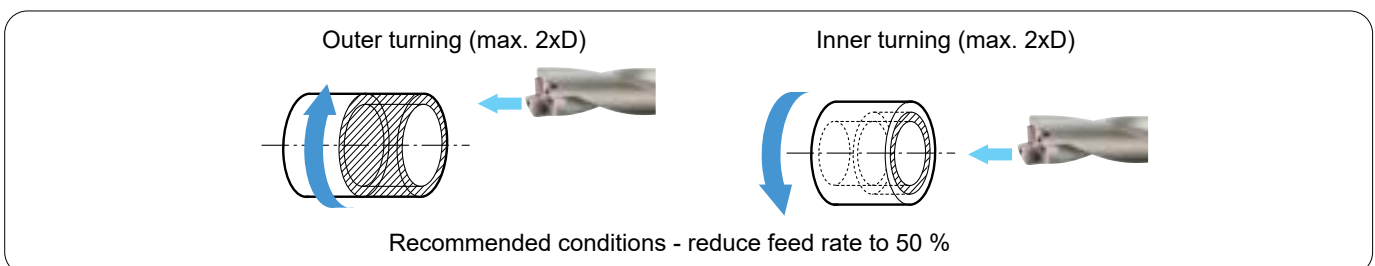

● = Euro stock

## Eccentric Sleeve **WAS** Type

The Eccentric Sleeve WAS Type, exclusively designed for "SumiDrill" WDX Type, provides up to  $\pm 0,3$  mm of hole size adjustment.

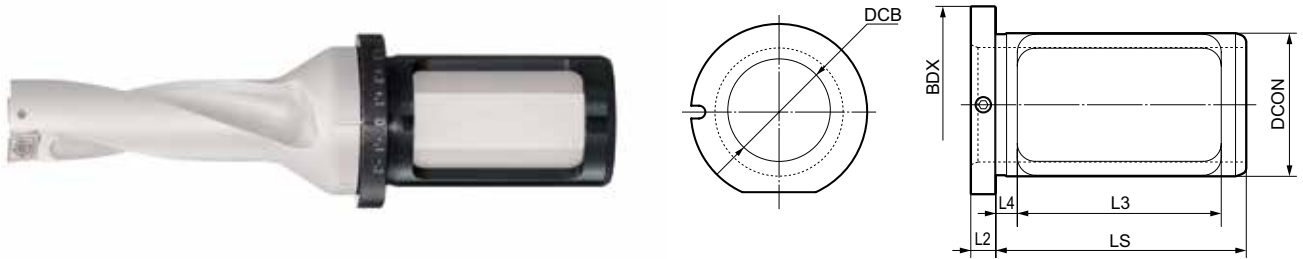

### ■ Dimensions

### ■ Parts

Cat. No.	Stock	DCB	DCON	BDX	LS	L2	L3	L4	Diameter Adjustment Range (max.)	Dimensions (mm)	
										Screw	Wrench
WAS 2025-48	●	20	25	33	43	5	32	5	+0,3 - -0,2	BT306	LH015
WAS 2532-60	●	25	32	42	60	7	46	6	+0,3 - -0,3	BT406	LH020
WAS 3240-70	●	32	40	55	70	7	57	6	+0,3 - -0,3	BT408	LH020
WAS 4050-85	●	40	50	60	70	7	54	6	+0,5 - -0,5	BT408	LH020

### ■ Diameter Adjustment

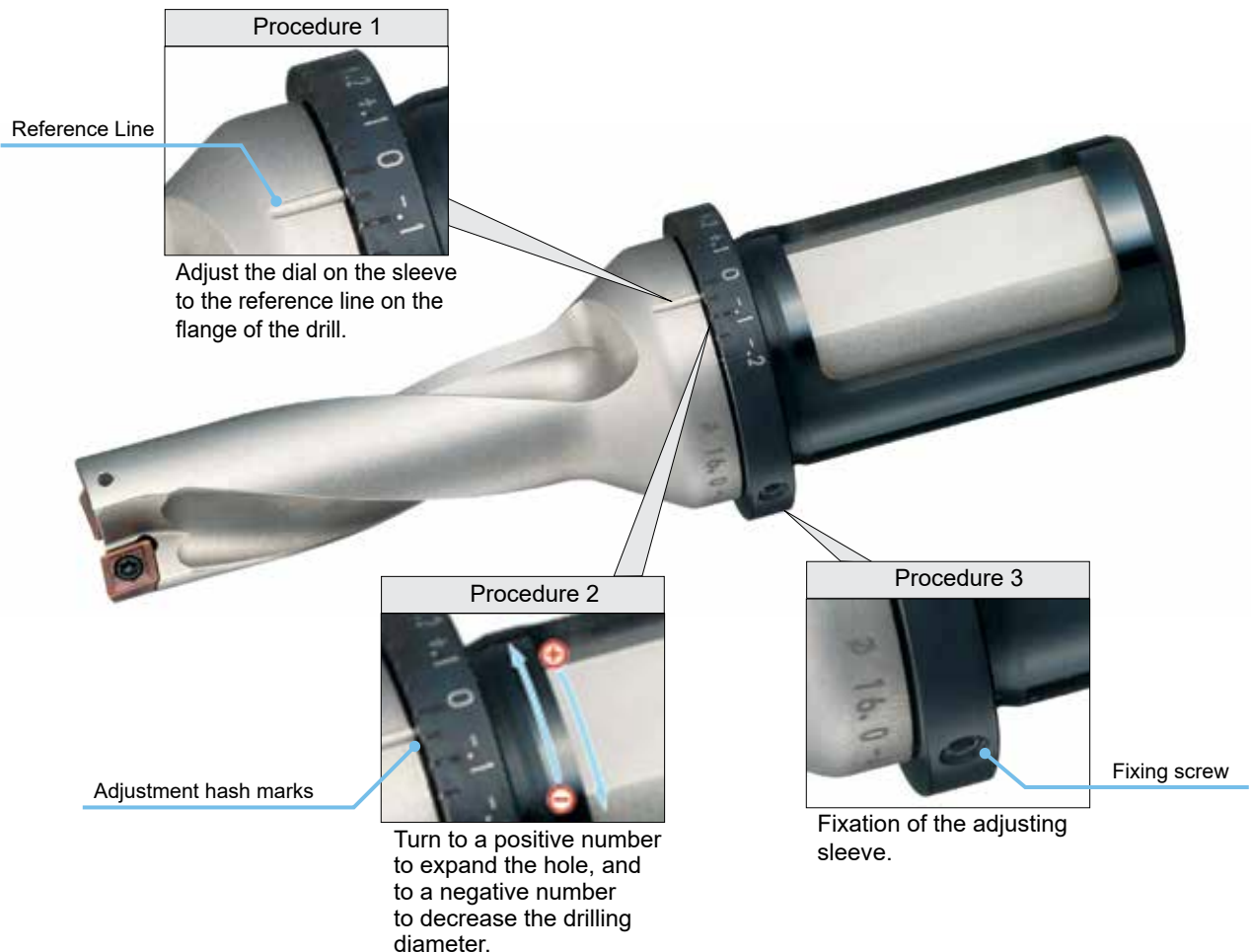

Note 1: The dial is for reference purposes. Always measure the actual drilling diameter and adjust accordingly.  
 Note 2: Not usable with collet chuck type holders. Only use with a side-locking holder like Weldon.

# Indexable Plunge Drill / Plunge Mill

## PDL Type / PCT Type



### Description

The tool cuts in the Z axis direction where tool rigidity is highest, allowing high efficiency roughing for aeronautic components and dies with long tool overhang must be used to machine deep holes and pockets.

- Characteristics**
  - The flat cutting edge design produces near-flat bottom profiles to reduce depth of cut variation during finishing.
  - All sizes come with an air hole for supplying coolant internally to improve chip evacuation.
  - Durable body with special surface treatment offers improved tool life and reliability.
  - The tools use SumiDrill WDX type inserts for handling a wide range of work materials, from steel to non-ferrous metals and exotic alloys.

- The PDL type has a central insert making it possible to make radial cuts beyond the tool's radius, pitch feed cutting, and drilling. (Pocket milling, etc.)

- Although the PCT type has limited radial cutting ability, the tool has many effective teeth enabling it to perform high feed cutting. (Medium finishing of corners, hole expansion, deep grooving, etc.)

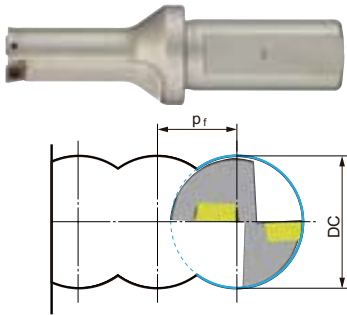

Keep the value of  $P_f$  for PDL type tools to less than 70 % of the tool diameter (DC).

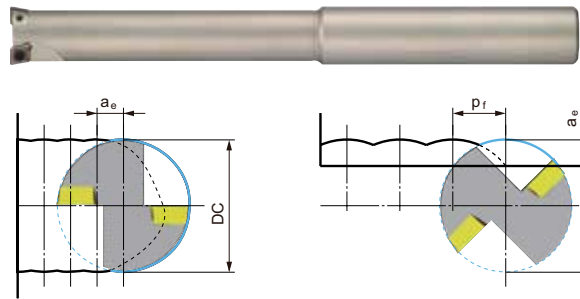

Keep the value of  $P_f$  for PCT type tools to less than 50 % of the tool diameter (DC).

For  $a_e$  refer to the dimension under "a<sub>e</sub> max" in the stock / dimensions tables titled "Holders Max, Depth: 3D/5D".

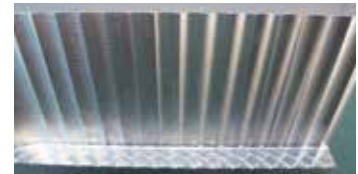

### Application examples

**PDL** Pocketing  
Work Material: Ti Alloy

Tool: PDL400D2S40 (Ø 40)  
Insert: WDXT125012-G  
Grade: ACK300

Cutting Conditions:  
 $v_c = 40$  m/min  
 $f = 0,07$  mm/rev  
( $v_f = 22,3$  mm/min)  
 $P_f = 25$  mm

**PCT** Corner Finishing  
Work Material: Ti Alloy

Tool: PCT320D3S32 (Ø 32)  
PCT250D3S25 (Ø 25)  
PCT200D3S20 (Ø 20)  
Grade: ACK300

Insert: WDXT094008-G  
WDXT073506-G  
WDXT063006-G

Cutting Conditions:  
 $v_c = 50$  m/min  
 $f_t = 0,08$  mm/tooth  
( $v_f = 80-127$  mm/min)  
 $a_e = 3,2-6,5$  mm

**PCT** Grooving  
Work Material: Ti Alloy

Tool: PCT320D5S32 (Ø 32)  
Insert: WDXT094008-G  
Grade: ACK300

Cutting Conditions:  
 $v_c = 40$  m/min  
 $f_t = 0,07$  mm/tooth  
( $v_f = 56$  mm/min)  
 $P_f = 5,0$  mm

**PDL** Drilling  
Work Material: X4 CrNiMo 17 12 2

Tool: PDL200D3S25 (Ø 20)  
Insert: WDXT063006-G  
Grade: ACP300

Cutting Conditions:  
 $v_c = 180$  m/min  
 $f = 0,10$  mm/rev  
( $v_f = 286$  mm/min)  
DC = 20 mm

**PCT** Aeronautic Components  
Work Material: X5 CrNi 18 10

Tool: PCT320D3S32 (Ø 32)  
Insert: WDXT094008-G  
Grade: ACP300

Cutting Conditions:  
 $v_c = 180$  m/min  
 $f_t = 0,15$  mm/tooth  
( $v_f = 537$  mm/min)  
 $a_e = 7,0$  mm,  $P_f = 5,0$  mm

**PCT** Machine Components  
Work Material: 34 Cr Ni 4

Tool: PCT200D5S20 (Ø 20)  
Insert: WDXT063006-G  
Grade: ACK300

Cutting Conditions:  
 $v_c = 150$  m/min  
 $f_t = 0,15$  mm/tooth  
( $v_f = 716$  mm/min)  
 $a_e = 3,5$  mm

● = Euro stock  
○ = Japan stock

Recommended Tightening Torque (N·m)

# Indexable Plunge Drill PDL Type (2D, 3D)



2D	3D	Carbon Steel, Alloy Steel	Tempered Steel	Hardened Steel	Stainless Steel	Ti Alloy	Heat Resistant Alloy	Cast Iron	Ductile Cast Iron	Al Alloy	Cu Alloy	Composite CFRP*
		C≤0.28% C>0.28%		HRC≤45 HRC>45								
w												

Fig 1

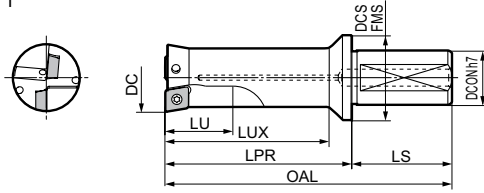
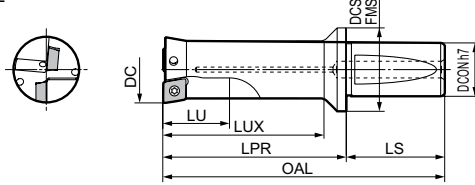

Fig 2



## Holder (Max ap: 2D)

Cat. No.	Stock	Dimensions (mm)							Applicable Insert	Fig.	
		DC	OAL	LU	LUX	LPR	LS	DCON			DCSFMS
PDL 160D2S20	●	16,0	94	32	35	50	44	20	28	WDXT052504	1
200D2S25	●	20,0	114	40	43	58	56	25	33	WDXT063006	
250D2S25	●	25,0	127	50	53	71	56	25	37	WDXT073506	
PDL 320D2S40	●	32,0	162	64	68	92	70	40	54	WDXT094008	2
400D2S40	●	40,0	185	80	85	115	70	40	54	WDXT125012	

## Holder (Max ap: 3D)

Cat. No.	Stock	Dimensions (mm)							Applicable Insert	Fig.	
		DC	OAL	LU	LUX	LPR	LS	DCON			DCSFMS
PDL 160D3S20	●	16,0	110	48	51	66	44	20	28	WDXT052504	1
200D3S25	●	20,0	134	60	63	78	56	25	33	WDXT063006	
250D3S25	●	25,0	152	75	78	96	56	25	37	WDXT073506	
PDL 320D3S40	●	32,0	194	96	100	124	70	40	54	WDXT094008	2
400D3S40	●	40,0	225	120	125	155	70	40	54	WDXT125012	

## Spare Parts

Screw	Wrench	Wrench	(N.m)	Applicable Holders
BFTX0204N	TRX06	-	0,5	PDL 160 D2 S20, PDL 160 D3 S20 PCT 160 D3 S16, PCT 160 D5 S16
BFTY02206	-	TRD07	1,0	PDL 200 D2 S25, PDL 200 D3 S25 PCT 200 D3 S20, PCT 200 D5 S20
BFTX02506N	-	TRD08	1,5	PDL 250 D2 S25, PDL 250 D3 S25 PCT 250 D3 S25, PCT 250 D5 S25
BFTX03584	-	TRD15	3,5	PDL 320 D2 S40, PDL 320 D3 S40 PCT 320 D3 S32, PCT 320 D5 S32
BFTX0511N	-	TRD20	5,0	PDL 400 D2 S40, PDL 400 D3 S40 PCT 400 D3 S42, PCT 400 D5 S42

## Notes about Mounting Inserts

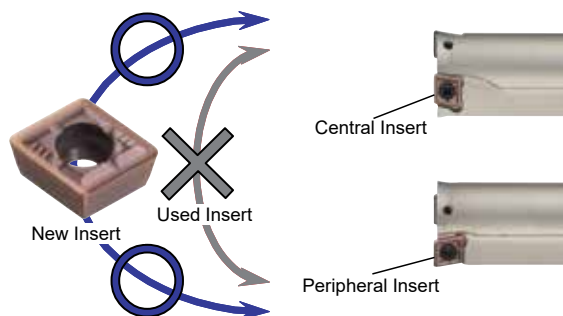

PDL type: Inserts can be used on either the centre or the outside. Inserts used on the outside cannot be used in the centre. Similarly, inserts used in the centre cannot be used on the outside.  
PCT type: 2 corners can be used only for the outer inserts.

# Indexable Plunge Mill PCT Type (3D, 5D)



3D	5D	Carbon Steel, Alloy Steel	Tempered Steel	Hardened Steel	Stainless Steel	Ti Alloy	Heat Resistant Alloy	Cast Iron	Ductile Cast Iron	Al Alloy	Cu Alloy	Composite CFRP*
		C≤0.28% C>0.28%		HRC≤45 HRC>45								
w												

\* CFRP (Carbon Fibre Reinforced Plastic)

Fig 3

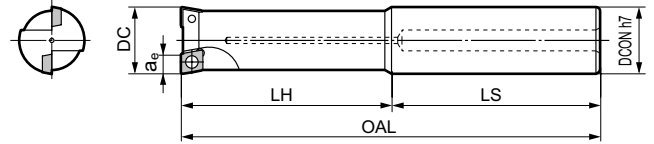

## Holder (Max ap: 3D)

Cat. No.	Stock	Dimensions (mm)						No. of teeth	Applicable Insert	Fig.
		DC	a <sub>e</sub> max	OAL	LH	LS	DCON			
PCT 160D3S16	●	16,0	4,0	123	53	70	16	2	WDXT052504	3
200D3S20	●	20,0	5,0	145	65	80	20	2	WDXT063006	
250D3S25	●	25,0	6,5	160	80	80	25	2	WDXT073506	
320D3S32	●	32,0	8,5	191	101	90	32	2	WDXT094008	3
400D3S42	●	40,0	11,0	225	125	100	42	3	WDXT125012	

## Holder (Max ap: 5D)

Cat. No.	Stock	Dimensions (mm)						No. of teeth	Applicable Insert	Fig.
		øD	a <sub>e</sub> max	OAL	LH	LS	DCON			
PCT 160D5S16	●	16,0	4,0	155	85	70	16	2	WDXT052504	3
200D5S20	●	20,0	5,0	185	105	80	20	2	WDXT063006	
250D5S25	●	25,0	6,5	210	130	80	25	2	WDXT073506	
320D5S32	●	32,0	8,5	255	165	90	32	2	WDXT094008	3
400D5S42	●	40,0	11,0	305	205	100	42	3	WDXT125012	

## Inserts

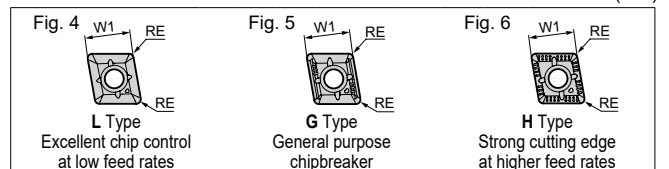

Application	Coated				Fig.	Dimensions (mm)			Applicable Holder
	ACP100	ACP300	ACK300	DL1500		W1	Thickness	RE	
High Speed / Light Cutting									N
General Purpose		M							
Roughing		PM	K						
Cat. No.	ACP100	ACP300	ACK300	DL1500	Fig.	W1	Thickness	RE	Applicable Holder
WDXT 052504-L	●	●	●	●	4				PDL160D2S20 PDL160D3S20 PCT160D3S16 PCT160D5S16
052504-G	●	●	●	●	5	5,0	2,5	0,4	
052504-H	●	●	●	●	6				
WDXT 063006-L	●	●	●	●	4				PDL200D2S25 PDL200D3S25 PCT200D3S20 PCT200D5S20
063006-G	●	●	●	●	5	6,0	3,0	0,6	
063006-H	●	●	●	●	6				
WDXT 073506-L	●	●	●	●	4				PDL250D2S25 PDL250D3S25 PCT250D3S25 PCT250D5S25
073506-G	●	●	●	●	5	7,5	3,5	0,6	
073506-H	●	●	●	●	6				
WDXT 094008-L	●	●	●	●	4				PDL320D2S40 PDL320D3S40 PCT320D3S32 PCT320D5S32
094008-G	●	●	●	●	5	9,6	4,0	0,8	
094008-H	●	●	●	●	6				
WDXT 125012-L	●	●	●	●	4				PDL400D2S40 PDL400D3S40 PCT400D3S42 PCT400D5S42
125012-G	●	●	●	●	5	12,4	5,0	1,2	
125012-H	●	●	●	●	6				

## Identification Details

PCT, PDL Type

**PCT 250 D3 S25**

Tool Diameter (ø 25,0) | Max Depth L/D (3D) | Shank Size (ø 25,0)

PCT, PDL Type Insert Identification

**WDXT 07 35 06 -G**

Width Across Flats (7,5) | Thickness x 10 (3,5) | Corner Radius x 10 (R0,6) | Breaker Type



# Recommended Cutting Conditions PDL Type / PCT Type

PDL

PCT (ø40)

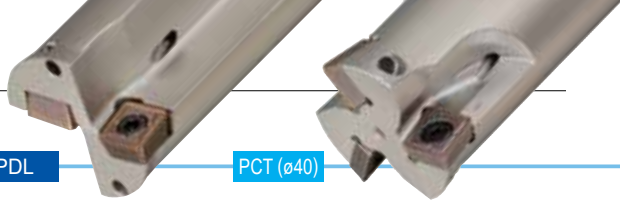

## Recommended Cutting Conditions (2D)

[ min. - optimal - max. ]

Material Group		Hardness (HB)	Chip breaker & Grade	Cutting Speed				PDL Type: f (mm/rev)			
ISO	Work material			Vc (m/min)		Ø 16,0	Ø 20,0–25,0	Ø 32,0	Ø 40,0		
P	Carbon steel	125	G ACP300	120–180–240	0,05–0,08–0,10	0,05–0,08–0,10	0,05–0,08–0,11	0,05–0,08–0,12			
		125	L ACP300	130–170–220	0,04–0,08–0,12	0,04–0,08–0,12	0,04–0,08–0,13	0,05–0,10–0,15			
		190	G ACP300	100–150–200	0,08–0,13–0,24	0,08–0,13–0,24	0,08–0,14–0,26	0,09–0,16–0,29			
		250	G ACP300	80–120–160	0,06–0,11–0,18	0,06–0,11–0,18	0,06–0,12–0,19	0,07–0,13–0,22			
		270	G ACP300	100–130–160	0,08–0,13–0,22	0,08–0,13–0,22	0,08–0,14–0,23	0,09–0,16–0,26			
	Low alloyed steel	300	G ACP300	70–100–140	0,06–0,11–0,17	0,06–0,11–0,17	0,06–0,12–0,18	0,07–0,13–0,20			
		180	L ACP300	100–140–180	0,05–0,08–0,14	0,05–0,08–0,14	0,05–0,08–0,16	0,06–0,09–0,17			
		275	G ACP300	80–120–160	0,06–0,11–0,17	0,06–0,11–0,17	0,06–0,12–0,18	0,07–0,13–0,20			
		300	G ACP300	75–110–140	0,06–0,11–0,17	0,06–0,11–0,17	0,06–0,12–0,18	0,07–0,13–0,20			
		350	G ACP300	60–85–110	0,06–0,11–0,17	0,06–0,11–0,17	0,06–0,12–0,18	0,07–0,13–0,20			
High alloyed steel	200	G ACP300	100–130–160	0,08–0,13–0,24	0,08–0,13–0,24	0,08–0,14–0,26	0,09–0,16–0,29				
	325	G ACP300	80–100–120	0,06–0,11–0,18	0,06–0,11–0,18	0,06–0,12–0,19	0,07–0,13–0,22				
M	Stainless steel, martensitic / ferritic, martensitic / tempered, austenitic / quenched, austenitic / ferritic (Duplex)	200	G ACP300	100–140–180	0,06–0,11–0,18	0,06–0,11–0,18	0,06–0,12–0,19	0,07–0,13–0,22			
		240	G ACP300	90–120–150	0,06–0,11–0,18	0,06–0,11–0,18	0,06–0,12–0,19	0,07–0,13–0,22			
		180	G ACP300	100–140–180	0,06–0,08–0,18	0,06–0,11–0,18	0,06–0,12–0,19	0,07–0,13–0,22			
		230	G ACP300	80–120–150	0,04–0,08–0,18	0,06–0,11–0,18	0,06–0,12–0,19	0,07–0,13–0,22			
K	Cast iron (GG)	180	H ACK300	120–160–200	0,09–0,20–0,32	0,10–0,22–0,36	0,11–0,24–0,39	0,12–0,26–0,44			
		260	H ACP300	90–120–150	0,09–0,20–0,32	0,10–0,22–0,36	0,11–0,24–0,39	0,12–0,26–0,44			
S	Heat resistant alloy	200	G ACP300	25–50–70	0,06–0,11–0,18	0,06–0,11–0,18	0,06–0,12–0,19	0,07–0,13–0,22			
		200	G ACP300	25–50–70	0,06–0,11–0,18	0,06–0,11–0,18	0,06–0,12–0,19	0,07–0,13–0,22			
N	Aluminium alloy		G DL1500	200–260–320	0,06–0,11–0,17	0,06–0,11–0,17	0,06–0,12–0,18	0,07–0,13–0,20			
			G DL1500	180–230–280	0,06–0,11–0,17	0,06–0,11–0,17	0,06–0,12–0,18	0,07–0,13–0,20			

## Recommended Cutting Conditions (3D)

[ min. - optimal - max. ]

Material Group		Hardness (HB)	Chip breaker & Grade	Cutting Speed				PDL Type: f (mm/rev) / PCT Type: f <sub>t</sub> (mm/tooth)			
ISO	Work material			Vc (m/min)		Ø 16,0	Ø 20,0–25,0	Ø 32,0	Ø 40,0		
P	Carbon steel	125	G ACP300	120–180–240	0,05–0,07–0,10	0,05–0,07–0,10	0,05–0,08–0,11	0,05–0,08–0,12			
		125	L ACP300	130–170–220	0,04–0,07–0,10	0,04–0,07–0,10	0,04–0,08–0,11	0,05–0,09–0,12			
		190	G ACP300	100–150–200	0,08–0,12–0,20	0,08–0,12–0,20	0,08–0,13–0,22	0,09–0,14–0,24			
		250	G ACP300	80–120–160	0,06–0,10–0,15	0,06–0,10–0,15	0,06–0,11–0,16	0,07–0,12–0,18			
		270	G ACP300	100–130–160	0,08–0,12–0,18	0,08–0,12–0,18	0,08–0,13–0,19	0,09–0,14–0,22			
	Low alloyed steel	300	G ACP300	70–100–140	0,06–0,10–0,14	0,06–0,10–0,14	0,06–0,11–0,15	0,07–0,12–0,17			
		180	L ACP300	100–140–180	0,05–0,07–0,12	0,05–0,07–0,12	0,05–0,07–0,13	0,06–0,07–0,15			
		275	G ACP300	80–120–160	0,06–0,10–0,14	0,06–0,10–0,14	0,06–0,11–0,15	0,07–0,12–0,17			
		300	G ACP300	75–110–140	0,06–0,10–0,14	0,06–0,10–0,14	0,06–0,11–0,15	0,07–0,12–0,17			
		350	G ACP300	60–85–110	0,06–0,10–0,14	0,06–0,10–0,14	0,06–0,11–0,15	0,07–0,12–0,17			
High alloyed steel	200	G ACP300	100–130–160	0,08–0,12–0,20	0,08–0,12–0,20	0,08–0,13–0,22	0,09–0,14–0,24				
	325	G ACP300	80–100–120	0,06–0,10–0,15	0,06–0,10–0,15	0,06–0,11–0,16	0,07–0,12–0,18				
M	Stainless steel, martensitic / ferritic, martensitic / tempered, austenitic / quenched, austenitic / ferritic (Duplex)	200	G ACP300	100–140–180	0,06–0,10–0,15	0,06–0,10–0,15	0,06–0,11–0,16	0,07–0,12–0,18			
		240	G ACP300	90–120–150	0,06–0,10–0,15	0,06–0,10–0,15	0,06–0,11–0,16	0,07–0,12–0,18			
		180	G ACP300	100–140–180	0,06–0,10–0,15	0,06–0,10–0,15	0,06–0,11–0,16	0,07–0,12–0,18			
		230	G ACP300	80–120–150	0,04–0,10–0,15	0,06–0,10–0,15	0,06–0,11–0,16	0,07–0,12–0,18			
K	Cast iron (GG)	180	H ACK300	120–160–200	0,09–0,18–0,27	0,10–0,20–0,30	0,11–0,22–0,32	0,12–0,24–0,36			
		260	H ACP300	90–120–150	0,09–0,18–0,27	0,10–0,20–0,30	0,11–0,22–0,32	0,12–0,24–0,36			
S	Heat resistant alloy	200	G ACP300	25–50–70	0,06–0,10–0,15	0,06–0,10–0,15	0,06–0,11–0,16	0,07–0,12–0,18			
		200	G ACP300	25–50–70	0,06–0,10–0,15	0,06–0,10–0,15	0,06–0,11–0,16	0,07–0,12–0,18			
N	Aluminium alloy		G DL1500	200–260–320	0,06–0,11–0,17	0,06–0,11–0,17	0,06–0,12–0,18	0,07–0,13–0,20			
			G DL1500	180–230–280	0,06–0,11–0,17	0,06–0,11–0,17	0,06–0,12–0,18	0,07–0,13–0,20			

## Recommended Cutting Conditions (5D)

[ min. - optimal - max. ]

Material Group		Hardness (HB)	Chip breaker & Grade	Cutting Speed				PCT Type: f <sub>t</sub> (mm/tooth)			
ISO	Work material			Vc (m/min)		Ø 16,0	Ø 20,0–25,0	Ø 32,0	Ø 40,0		
P	Carbon steel	125	G ACP300	120–180–240	0,05–0,06–0,09	0,05–0,06–0,09	0,05–0,06–0,09	0,05–0,07–0,09			
		125	L ACP300	130–170–220	0,04–0,06–0,08	0,04–0,06–0,08	0,04–0,06–0,08	0,05–0,07–0,09			
		190	G ACP300	100–150–200	0,07–0,10–0,15	0,07–0,10–0,15	0,08–0,11–0,17	0,09–0,12–0,19			
		250	G ACP300	80–120–160	0,05–0,09–0,11	0,05–0,09–0,11	0,06–0,09–0,12	0,06–0,10–0,14			
		270	G ACP300	100–130–160	0,07–0,10–0,14	0,07–0,10–0,14	0,08–0,11–0,15	0,09–0,12–0,17			
	Low alloyed steel	300	G ACP300	70–100–140	0,05–0,09–0,11	0,05–0,09–0,11	0,06–0,09–0,12	0,06–0,10–0,13			
		180	L ACP300	100–140–180	0,05–0,06–0,09	0,05–0,06–0,09	0,05–0,06–0,10	0,05–0,07–0,11			
		275	G ACP300	80–120–160	0,05–0,09–0,11	0,05–0,09–0,11	0,06–0,09–0,12	0,06–0,10–0,13			
		300	G ACP300	75–110–140	0,05–0,09–0,11	0,05–0,09–0,11	0,06–0,09–0,12	0,06–0,10–0,13			
		350	G ACP300	60–85–110	0,05–0,09–0,11	0,05–0,09–0,11	0,06–0,09–0,12	0,06–0,10–0,13			
High alloyed steel	200	G ACP300	100–130–160	0,07–0,10–0,15	0,07–0,10–0,15	0,08–0,11–0,17	0,09–0,12–0,19				
	325	G ACP300	80–100–120	0,05–0,09–0,11	0,05–0,09–0,11	0,06–0,09–0,12	0,06–0,10–0,14				
M	Stainless steel, martensitic / ferritic, martensitic / tempered, austenitic / quenched, austenitic / ferritic (Duplex)	200	G ACP300	100–140–180	0,05–0,09–0,11	0,05–0,09–0,11	0,06–0,09–0,12	0,06–0,10–0,14			
		240	G ACP300	90–120–150	0,05–0,09–0,11	0,05–0,09–0,11	0,06–0,09–0,12	0,06–0,10–0,14			
		180	G ACP300	100–140–180	0,05–0,09–0,11	0,05–0,09–0,11	0,06–0,09–0,12	0,06–0,10–0,14			
		230	G ACP300	80–120–150	0,05–0,09–0,11	0,05–0,09–0,11	0,06–0,09–0,12	0,06–0,10–0,14			
K	Cast iron (GG)	180	H ACK300	120–160–200	0,08–0,15–0,21	0,09–0,17–0,23	0,09–0,18–0,25	0,11–0,20–0,28			
		260	H ACP300	90–120–150	0,08–0,15–0,21	0,09–0,17–0,23	0,09–0,18–0,25	0,11–0,20–0,28			
S	Heat resistant alloy	200	G ACP300	25–50–70	0,05–0,09–0,11	0,05–0,09–0,11	0,06–0,09–0,12	0,06–0,10–0,14			
		200	G ACP300	25–50–70	0,05–0,09–0,11	0,05–0,09–0,11	0,06–0,09–0,12	0,06–0,10–0,14			
N	Aluminium alloy		G DL1500	200–260–320	0,05–0,10–0,15	0,05–0,10–0,15	0,06–0,11–0,16	0,06–0,12–0,18			
			G DL1500	180–230–280	0,05–0,10–0,15	0,05–0,10–0,15	0,06–0,11–0,16	0,06–0,12–0,18			

Multi-Drills

# SUMIBORON SUMIDIA

L1–L32

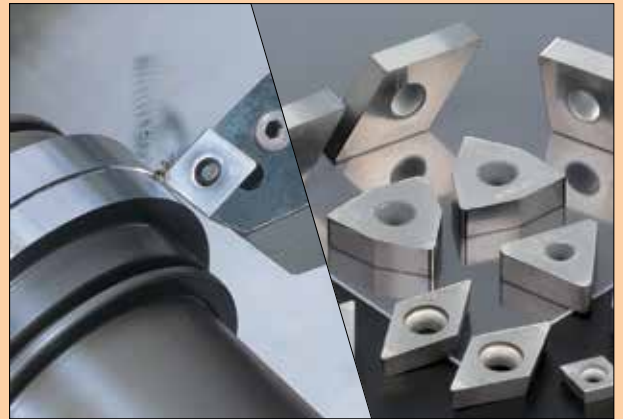

SUMIBORON Guidance for SUMIBORON Grades	<p><b>SUMIBORON Series</b> ..... L2</p> <p><b>Coated SUMIBORON Series</b>..... L3</p> <p><b>Grade Guidance - Cutting Hardened Steel</b> ..... L4</p> <p><b>Grade Guidance - Cutting Cast Iron</b> ..... L5</p> <p><b>Grade Guidance - Cutting Sintered Components/Titanium Alloy</b> ..... L6</p> <p><b>Grade Guidance - Cutting Rolls/Hard Facing/Heat resistant Alloys</b> ..... L7</p>
SUMIBORON Inserts	<p><b>SUMIBORON Cutting Edge Specification</b> ..... L8</p> <p><b>SUMIBORON Break Master NFV<sub>Type</sub>/NLV<sub>Type</sub>/NSV<sub>Type</sub></b> ..... L10</p> <p><b>SUMIBORON One-Use Wiper Inserts WG<sub>Type</sub>/WH<sub>Type</sub></b> ..... L11</p>
SUMIBORON Grades	<p><b>SUMIBORON BN1000/BN2000</b> ..... L12</p> <p>Coated SUMIBORON BNC2115/BNC2125/BNC2010/BNC2020 ..... L14</p> <p>Coated SUMIBORON BNC300/SUMIBORON BN350 ..... L17</p> <p><b>SUMIBORON BN7000/BN7115</b> ..... L18</p> <p>Coated SUMIBORON BNC8115/ <b>SUMIBORON BNS8125</b> ..... L20</p> <p>Coated SUMIBORON BNC500 ..... L22</p>
SUMIBORON Binderless	<p><b>SUMIBORON Binderless NCB100</b> ..... L24</p>
SUMIDIA	<p><b>Production Process</b>..... L26</p>
SUMIDIA Grades	<p><b>SUMIDIA Binderless NPD10/SUMIDIA DA90</b> ..... L28</p> <p><b>SUMIDIA DA1000</b> ..... L30</p>
SUMIDIA Inserts	<p><b>SUMIDIA NF<sub>Type</sub></b> ..... L30</p> <p><b>SUMIDIA Break Master NLD<sub>Type</sub>/NGD<sub>Type</sub></b> ..... L31</p> <p><b>SUMIDIA Break Master L/R DM<sub>Type</sub></b> ..... L32</p>



# CBN Tools SUMIBORON series

## New generation Sumiboron inserts – an even better way to machine hardened steels



### ■ General

Building on its global success machining hardened steels with Sumiboron inserts the addition of heat and wear resistant coatings to a variety of tough new CBN substrates has resulted in a new generation of high performance grades. With economy in mind the new inserts are multi cornered.

Choose the coated insert suitable for your application and take your hard part machining operations to the new industry standard.

The sintered CBN tool SUMIBORON is mainly used for the machining of ferrous metals due to its low chemical reactivity with iron. There are 4 different classifications of SUMIBORON as follows:

### ■ Classifications / Applications

Classifications	Structure	Diagram	Grade	Work Material
With a high CBN content, where each grain is fused together, this group can be used for the machining of high-hardness materials like cast iron, heat-resistant alloys and sintered alloys.		<p>CBN grain</p> <p>Metal binder</p>	BN700	<b>K</b> (FC) <b>S</b>
			BN7000	
			<b>BN7115</b>	
			BN7500	
			<b>BNS8125</b>	
			BNS800	
The group where CBN grains are held together by a special ceramic binder with a strong binding force provides excellent wear resistance and toughness in the machining of hardened steel and cast iron.		<p>Special ceramic coating</p> <p>CBN</p>	<b>BNC8115</b>	<b>K</b> (FC/FCD) <b>S</b> <b>H</b>
			BN1000	
			BN2000	
			BN350	
			BNX10	
			BNX20	
			BNX25	
			BN500	
			<b>BNC2115</b>	
			<b>BNC2125</b>	
SUMIBORON with special ceramic coating. The CBN and coating exhibit the hardness, toughness, thermal resistance and oxidation resistance that tool material requires for excellent cutting performance.		<p>Special ceramic coating</p> <p>CBN</p>	BNC2010	<b>H</b>
			BNC2020	
			BNC300	
			BNC100	
			BNC160	
			BNC200	
			BNC500	
Products containing no binder, with a structure of directly bonded nano-to sub-micron CBN particles which provides excellent hardness and thermal conductivity, making them highly efficient with long tool life when machining exotic alloys such as titanium alloys and cobalt-chrome alloys.		<p>CBN particles (no binder)</p>	NCB100	<b>K</b> (FC) <b>S</b>

Sintered Alloy

Cemented Carbide

Hard Brittle Material

# Coated SUMIBORON Characteristics

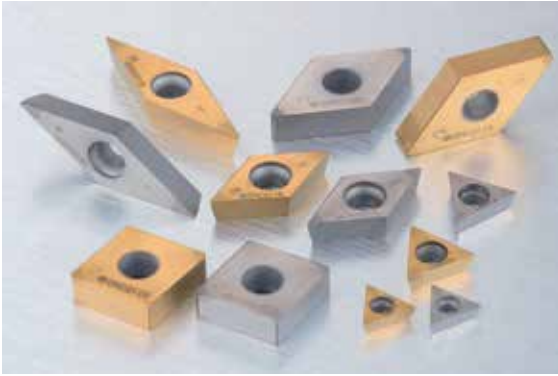

New Coated SUMIBORON Series achieving

- higher speed
- higher efficiency and
- higher precision

## ■ General Features

Using a high heat resistant and tough CBN substrate coupled with a special ceramic coating, this series caters to a wide variety of applications with improved precision and longer tool life as compared to conventional CBN.

There is a comprehensive lineup of economical and easy-to-use insert selection, such as the cost effective double-sided, multi-cornered, one-use type inserts.

## ■ Features

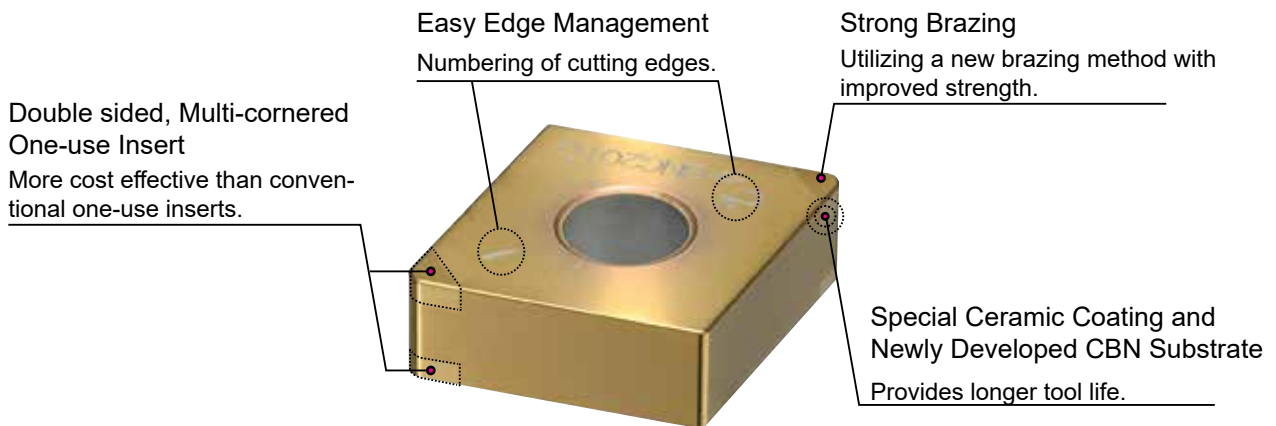

## ■ Cutting Edge Management

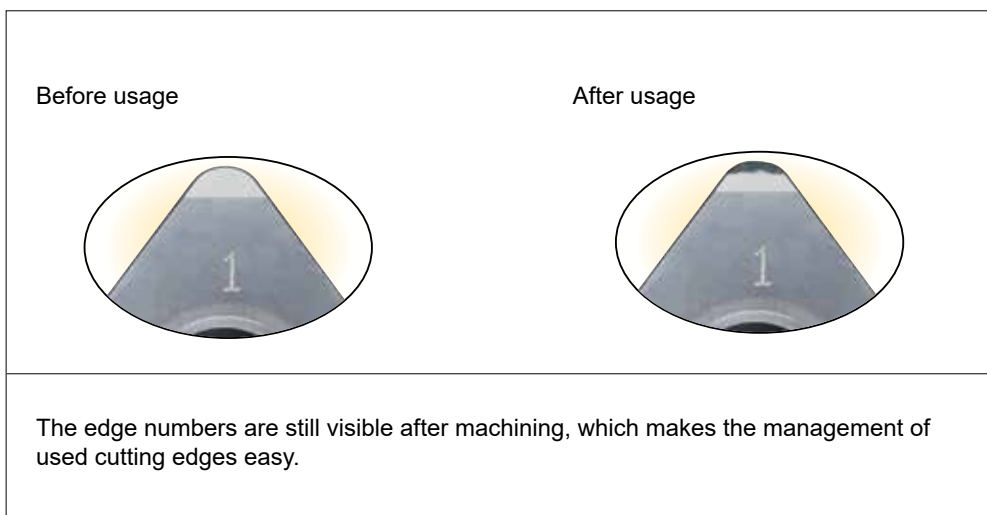

# Grade Guidance

## H Hardened Steel Machining

### Advantages of Using CBN

In terms of cost investment, it is much lower in machine cost and overhead cost due to the fact that a CNC lathe is cheaper than a grinding machine. As for the quality of finish, inserts can machine different profiles and the finishing is also commendable as compared to grinding. Environmentally, sludge treatment for grinding is a hazard to the environment but for turning, the chips can be collected and recycled.

### Recommended Grades

Grade	Binder	CBN Content (%)	Grain Size (µm)	Hardness HV (GPa)	TRS (GPa)	Main Coating Components	Coating Thickness (µm)	Features
<b>New</b> BNC2115	TiN	60-65	3	31-33	1,3-1,4	TiAlSiN Super Multi-layered Coating	3	Maintains excellent surface roughness thanks to coating with high notch wear resistance and tough CBN substrate.
<b>New</b> BNC2125	TiN	65-70	4	33-35	1,5-1,6	TiAlSiN Super Multi-layered Coating	3	Along with a tough CBN substrate, the coating combines wear resistance and toughness to achieve even more stable machining.
BNC2010	TiCN	50-55	2	30-32	1,1-1,2	TiCN Multiple Layers	2	Improved wear resistance from coating and substrate, achieves excellent and consistent surface finish.
BNC2020	TiN	70-75	5	34-36	1,4-1,5	TiCN Multiple Layers	2	Utilising a tough substrate along with a highly wear-resistant and adhesive coating layer, to achieve long tool life in general-purpose to high-efficiency machining.
BNC300	TiN	60-65	1	33-35	1,5-1,6	TiAlN	1	Suitable for finishing work materials combining continuous and interrupted cutting.
BNC100	TiN	40-45	1	29-32	1,0-1,1	TiAlN/TiCN	3	Suitable for high-speed finishing thanks to highly wear-resistant coating.
BNC160	TiN	60-65	3	31-33	1,2-1,3	TiAlN/TiCN	3	Achieves stable, high-precision finishing of hardened steel.
BNC200	TiN	65-70	4	33-35	1,4-1,5	TiAlN	3	Provides long tool life thanks to tough substrate and highly wear-resistant coating.
<b>New</b> BNC8115	Al Alloy	85-90	8	39-42	0,95-1,15	TiAlN	2	Grade with 100% solid CBN structure, using PVD coating with excellent wear resistance to enable roughing operations.
<b>Uncoated</b> BN1000	TiCN	40-45	1	27-31	0,9-1,0	-	-	Achieves ultimate wear and fracture resistance. Suitable for high-speed cutting.
BN2000	TiN	50-55	2	31-34	1,1-1,2	-	-	General-purpose grade for hardened steel machining with a high degree of fracture and wear resistance.
BNX20	TiN	55-60	3	31-33	1,0-1,1	-	-	Achieves excellent crater wear resistance. Suitable for high-efficiency cutting under high-temperature conditions.
BN350	TiN	60-65	1	33-35	1,5-1,6	-	-	Achieves ultimate cutting edge strength. Suitable for heavy interrupted cutting.
BNX10	TiCN	40-45	3	27-31	0,9-1,0	-	-	Excellent wear resistance. Suited to continuous high-speed cutting.
BNX25				29-31	1,0-1,1	-	-	High efficiency cutting (continuous-interrupted). Excellent fracture resistance in interrupted cutting at high cutting speed.

### Application Range

#### Coated SUMIBORON

- Induction Hardened Steel (C45, C55, etc.), Carburised Steel

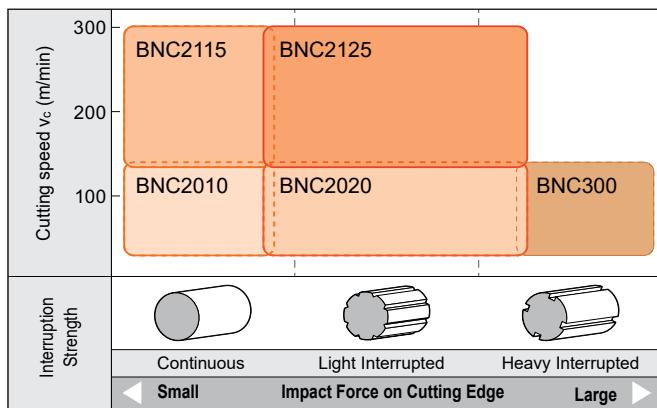

#### Uncoated SUMIBORON

- Induction Hardened Steel (C45, C55, etc.), Carburised Steel

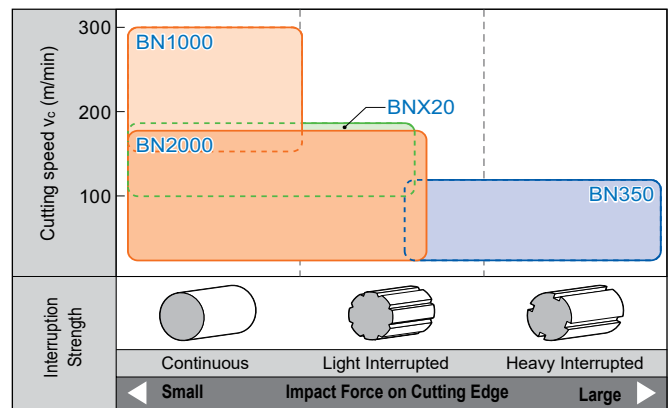

- Die Steel (X155CrVMo12-1, X40CrVMo5-1, etc.), HSS

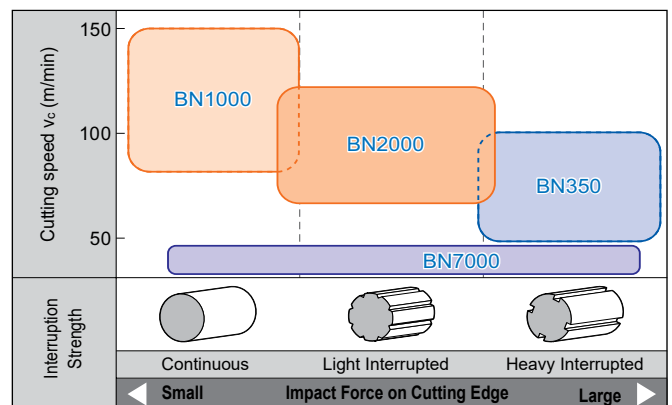

# Grade Guidance

## K Cast Iron Machining

### Advantages of Using CBN

Following charts show merits of using CBN in cast iron machining compared with conventional tools, such as carbide, cermet or ceramics. SumiBoron performs longer tool life than conventional tools in high speed machining and brings higher efficiency and superior precision.

#### High Speed Machining

- Grey Cast Iron

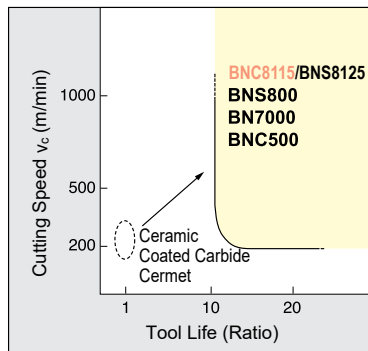

#### High Speed Machining

- Ductile Cast Iron

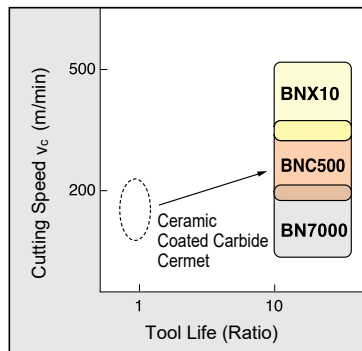

#### High Precision Machining

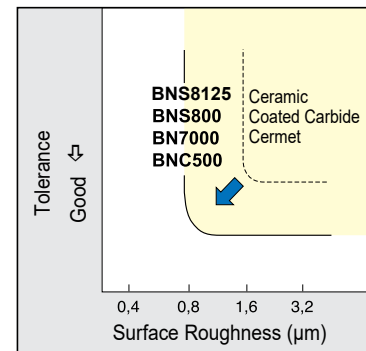

### Recommended Grades

	Grade	Binder	CBN Content (%)	Grain Size (µm)	Hardness HV (GPa)	TRS (GPa)	Main Coating Components	Coating Thickness (µm)	Features
Uncoated	<b>BNS8125</b> <small>New</small>	Al Alloy	85-90	8	39-42	0,95-1,15	-	-	Grade with 100% solid CBN structure that exhibits excellent wear and fracture resistance.
	<b>BNS800</b>	Al Alloy	85-90	8	39-42	0,9-1,1	-	-	Grade with solid CBN structure that has excellent thermal shock resistance.
	<b>BN7000</b>	Co Compounded	90-95	2	41-44	1,8-1,9	-	-	Grade exhibiting wear and fracture resistance in cutting of cast iron and exotic alloys.
	<b>BN500</b>	TiC	65-70	6	32-34	1,0-1,1	-	-	Grade optimised for cast iron cutting. Provides superior wear and fracture resistance.
Coated	<b>BNC8115</b> <small>New</small>	Al Alloy	85-90	8	39-42	0,95-1,15	TiAlN	2	Grade with 100% solid CBN structure, using PVD coating with excellent wear resistance that enables roughing operations.
	<b>BNC500</b>	TiC	85-90	4	32-34	1,1-1,2	TiAlN	3	Suitable for machining of hard-to-cut cast iron, thanks to the highly wear-resistant substrate and coating.

### Application Range

- Grey Cast Iron

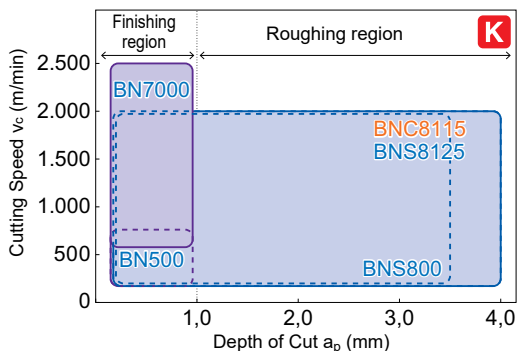

- Ductile Cast Iron

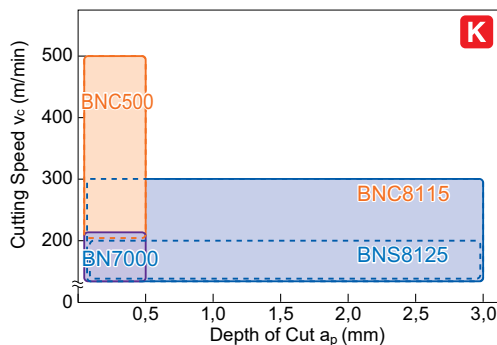

- Special Cast Iron

Work Material	Hardness (HB)	Work Material Structure	Examples	Cutting Speed $v_c$ (m/min)				
				100	200	300	350	400
Ni-resistant cast iron	150-200	Austenite	Piston ring	BNC500				
High-Cr cast iron	250-350	Austenite	Pump part	BNS8125/BNS800				
FCV (CGI)	400-580	Pearlite	Engine blocks Cylinder heads Brake discs	BNC500				

# Grade Guidance



## Sintered Component Machining

### Advantages

SUMIBORON has much smaller edge wear than cemented carbide or cermet. It also has better wear resistance and can form a shape edge easily. SUMIBORON is able to prevent burrs and chipping on the edges of the workpiece, achieving good machined precision and surface roughness.

### Recommended Grades

	Grade	Binder	CBN Content (%)	Grain Size (μm)	Hardness HV (GPa)	TRS* (GPa)	Main Coating Components	Coating Thickness (μm)	Features
Uncoated	<b>BN7115</b> <small>New</small>	Co Compounded	90-95	1	41-44	2,2-2,3	-	-	Grade balancing ultimate cutting edge sharpness with fracture resistance, suitable for finishing of sintered alloy.
	BN7500	Co Compounded	90-95	1	41-44	2,0-2,1	-	-	Grade maintaining good cutting edge sharpness, suitable for finishing of sintered alloy.
	BN7000	Co Compounded	90-95	2	41-44	1,8-1,9	-	-	Grade exhibiting improved wear and fracture resistance in roughing of sintered materials.

\*Transverse rupture strength measured with test piece equivalent to insert CBN layer.

### Application Range

#### General Sintered Alloy

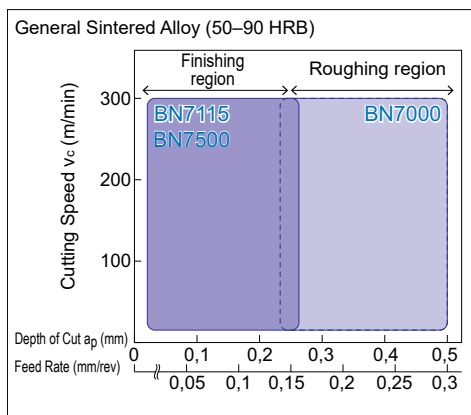

#### High Density/Sintered Alloy

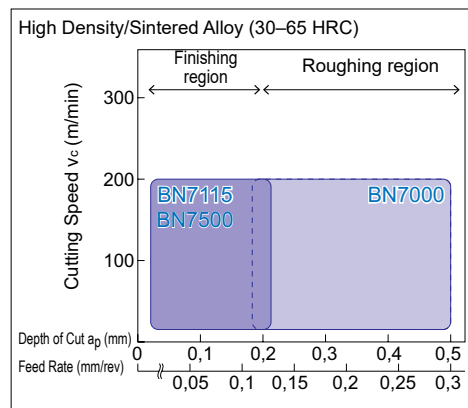

## Titanium Alloy Cutting

### Advantages

SUMIBORON enables high speed machining of titanium alloys that were previously difficult to machine with conventional tools, drastically improving machining efficiency.

### Recommended Grades

Grade	Binder	CBN Content (%)	Grain Size (μm)	Hardness HV (GPa)	TRS* (GPa)	Main Coating Components	Coating Thickness (μm)	Features
NCB100	-	100	≤ 0,5	51-54	1,8-1,9	-	-	Ideal for high-efficiency finishing of titanium alloy.

\*Transverse rupture strength measured with test piece equivalent to insert CBN layer.

### Cutting Performance

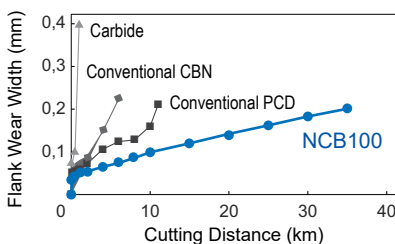

Work Material: Titanium Alloy (Ti-6Al-4V)  
 Insert: CNGA120408  
 Cutting Data:  $v_c = 150$  m/min,  $f = 0,15$  mm/rev,  $a_p = 0,5$  mm  
 wet (high pressure coolant)

### Recommended Cutting Conditions

Work Material		Grade	Recommended Cutting Conditions		
Composition	Hardness (HRC)		Cutting Speed $v_c$ (m/min)	Feed Rate $f$ (mm/rev)	Depth of Cut $a_p$ (mm)
Ti-6Al-4V	30-35	NCB100	50 100 150 200 250 300	0,05-0,15-0,20	0,10-0,30-0,50
Ti-5Al-5V-5Mo-3Cr	32-38	NCB100	50 100 150 200 250 300	0,05-0,10-0,20	0,10-0,30-0,50
Ti-10V-2Fe-3Al	32-38	NCB100	50 100 150 200 250 300	0,05-0,10-0,20	0,10-0,30-0,50



## Roll Machining

### Advantages

SUMIBORON enables the machining of high-hardness rolls that were previously difficult to machine with conventional tools, drastically improving machining efficiency.

### Recommended Grades

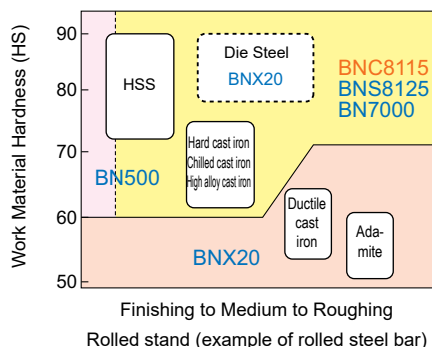

### Recommended Cutting Conditions

Work Material		Recommended Cutting Conditions						
Category	Hardness (HS)	Cutting Speed $v_c$ (m/min)				Feed Rate $f$ (mm/rev)	Depth of Cut $a_p$ (mm)	
		20	40	60	80	100	120	140
Adamite	$\geq 40$	[Bar from 40 to 120]				0,1–0,5	0,2–3,0	
Chilled cast iron	$\geq 60$	[Bar from 40 to 120]				0,1–0,5	0,2–3,0	
High-alloy cast iron	$\geq 60$	[Bar from 40 to 120]				0,1–0,5	0,2–3,0	
HSS	$\geq 70$	[Bar from 20 to 60]				0,1–0,4	0,1–3,0	

## Hard Facing Alloy Machining

### Advantages

SUMIBORON enables the machining of high-hardness facing alloys that were previously difficult to machine with conventional tools, drastically improving machining efficiency. The first recommended grade is BN7000, followed by BNS8125.

### Cutting Performance

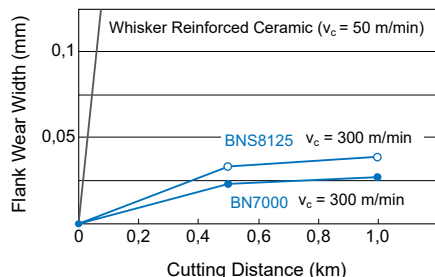

Work Material: Colmomoy No. 6 (Ni-based self-fluxing alloy)  
 Insert: SNGN090308  
 Cutting Data:  $f = 0,1$  mm/rev,  $a_p = 0,2$  mm dry

BN7000 has a long tool life and minimal wear with high speed cutting.

### Recommended Cutting Conditions

Work Material		Recommended Cutting Conditions					
Category	Material	Cutting Speed $v_c$ (m/min)				Feed Rate $f$ (mm/rev)	Depth of Cut $a_p$ (mm)
		50	100	200	300		
Ni-based self-fluxing alloy	Colmomoy No. 6	[Bar from 100 to 300]				0,05–0,2	0,1–3,0
Co-based self-fluxing alloy	Stellite	[Bar from 50 to 100]				0,05–0,2	0,1–1,0

## Heat Resistant Alloy Machining

### Advantages

SUMIBORON provides long tool life in the finishing of heat-resistant alloys.

### Recommended Grades

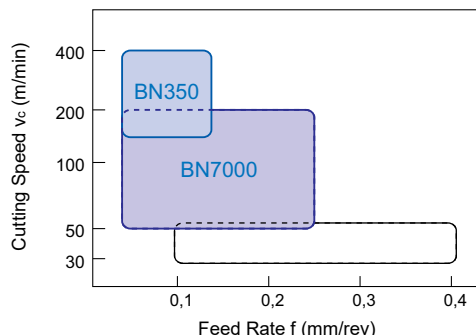

SUMIBORON is best suited for finishing of heat-resistant steel.

### Recommended Cutting Conditions

Work Material		Recommended Cutting Conditions					
Category	Material	Cutting Speed $v_c$ (m/min)				Feed Rate $f$ (mm/rev)	Depth of Cut $a_p$ (mm)
		50	100	150	200		
Ni-based heat-resistant alloy	Inconel 718	[Bar from 100 to 200]				0,05–0,2	0,1–1,0
Co-based heat-resistant alloy	Stellite	[Bar from 50 to 100]				0,05–0,2	0,1–1,0



# Edge Specification of SUMIBORON Inserts

## Sumiboron Inserts and Edge Preparation

All SUMIBORON inserts are enhanced with the optimum cutting edge preparation for various grades and geometries (shown on the right).

This is to avoid cutting edge fracture caused by the heavy loads generated during the machining of high hardness materials such as Hardened Steel.

As the pioneer of CBN tools „SUMIBORON“, various selection of grades and edge preparation combinations is our strong point for Hardened Steel machining.

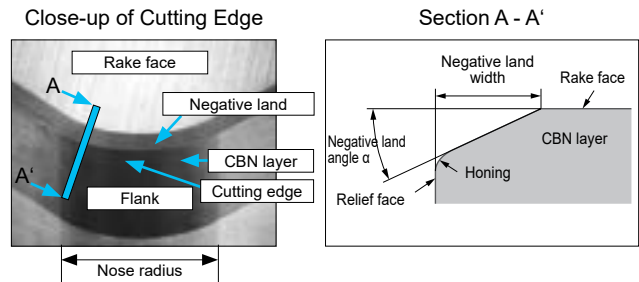

### SUMIBORON Insert Cutting Edge Specification

Series	Work Material	Grade	Negative / Positive	Standard			Low Cutting Force L / High Efficiency Type E				Strong Edge Type H							
				Identification Code	$\alpha$	W	Honing	Notation	Identification Code	$\alpha$	W	Honing	Notation	Identification Code	$\alpha$	W	Honing	
Uncoated SUMIBORON	Hardened Steel	<b>BNX10</b>	Neg./Pos.	T01225	25°	0,12	No	—	—	—	—	—	—	—	—	—	—	
		<b>BNX20</b>	Neg./Pos.	S01225	25°	0,12	Yes	<b>LT</b>	T01215*	15°	0,12	No	—	—	—	—	—	
		<b>BNX25</b>	Neg./Pos.	S01725	25°	0,17	Yes	—	—	—	—	—	—	—	—	—	—	
		<b>BN1000</b>	Neg./Pos.	S01225	25°	0,12	Yes	—	—	—	—	—	—	—	—	—	—	
		<b>BN2000</b>	Neg./Pos.	S01225	25°	0,12	Yes	<b>LT</b>	T01215	15°	0,12	No	<b>HS</b>	S01235	35°	0,12	Yes	
		<b>BN350</b>	Neg./Pos.	T01225	25°	0,12	No	—	—	—	—	—	<b>HT</b>	T01235	35°	0,12	No	
	Cast Iron	<b>BN700</b>	Neg./Pos.	T01215	15°	0,12	No	<b>LF</b>	(Sharp edge)	0°	0	No	<b>HS</b>	S01225	25°	0,12	Yes	
			Neg./Pos.	T01215	15°	0,12	No	<b>LF</b>	(Sharp edge)	0°	0	No	<b>HS</b>	S01225	25°	0,12	Yes	
		<b>BN7115</b>	Neg./Pos.	T01215	15°	0,12	No	<b>LF</b>	(Sharp edge)	0°	0	No	<b>HS</b>	S00525	25°	0,05	Yes	
							Yes	<b>LE</b>	(Sharp edge)	0°	0	Yes	<b>US</b>	S01225	25°	0,12	Yes	
Sintered Alloy		<b>BN7500</b>	Neg./Pos.	T01215	15°	0,12	No	<b>LF</b>	(Sharp edge)	0°	0	No	—	—	—	—	—	
							Yes	<b>LS</b>	S00715	15°	0,05	—	—	—	—	—	—	—
		Exotic Alloy	<b>BN7500</b>	Neg./Pos.	T01215	15°	0,12	Yes	<b>LE</b>	(Sharp edge)	0°	0	Yes	<b>HS</b>	S00525	25°	0,05	Yes
								Yes	<b>LS</b>	S00715	15°	0,07	Yes	—	—	—	—	—
Coated SUMIBORON	Hardened Steel	<b>BNC2115</b>	Neg./Pos.	S01225	25°	0,12	Yes	<b>LS</b>	S00515	15°	0,05	Yes	<b>HS</b>	S01730	30°	0,17	Yes	
		<b>BNC2125</b>	Neg./Pos.	S01225	25°	0,12	Yes	<b>LS</b>	S00515	15°	0,05	Yes	<b>HS</b>	S02735	35°	0,27	Yes	
		<b>BNC2010</b>	Neg./Pos.	S01225	25°	0,12	Yes	<b>LE</b>	(Sharp edge)	0°	0	Yes	<b>HS</b>	S01730	30°	0,17	Yes	
		<b>BNC2020</b>	Neg./Pos.	S01225	25°	0,12	Yes	<b>LT</b>	T00515	15°	0,05	No	<b>HS</b>	S02735	35°	0,27	Yes	
		<b>BNC100</b>	Neg./Pos.	S01225	25°	0,12	Yes	<b>ES</b>	S00535	35°	0,05	Yes	—	—	—	—		
		<b>BNC160</b>	Neg./Pos.	S01225	25°	0,12	Yes	<b>LS</b>	S01715	15°	0,17	Yes	—	—	—	—		
		<b>BNC200</b>	Neg./Pos.	S01225	25°	0,12	Yes	<b>LS</b>	S01020	20°	0,10	Yes	<b>HS</b>	S01730	30°	0,17	Yes	
		<b>BNC300</b>	Neg./Pos.	S01225	25°	0,12	Yes	<b>LS</b>	S01015	15°	0,10	Yes	<b>HS</b>	S01735	35°	0,17	Yes	
	Cast Iron	<b>BNC500</b>	Neg./Pos.	S01215	15°	0,12	Yes	—	—	—	—	—	<b>HS</b>	S01225	25°	0,12	Yes	
		<b>BNC8115</b>	Neg.	S02020	20°	0,20	Yes	—	—	—	—	—	—	—	—	—	—	
Blinder-less CBN	Cast Iron, Exotic Alloy, Carbide, Cermet	<b>NCB100</b>	Neg./Pos.	T01215	15°	0,12	No	—	—	—	—	—	—	—	—	—		

\* BNX20 Identification code will be T00715 for inserts with inscribed circle of less than  $\varnothing 4,76$ .

### Cutting Edge Preparation of Inserts with Wiper / Chipbreakers

Type	Notation	Edge Specification Identification Code	$\alpha$	W	Honing	Uncoated SUMIBORON		Coated SUMIBORON									
						BN2000	BN8125	BN800	BNC2115	BNC2125	BNC2010	BNC2020	BNC100	BNC160	BNC200	BNC500	BNC8115
Wiper	<b>WG</b>	S01215	15°	0,12	Yes	●		●	●	●	●	●	●	●	●	●	●
	<b>WH</b>	S01215	15°	0,12	Yes	●		●	●	●	●	●	●	●	●	●	●
	<b>W</b>	S01215	15°	0,12	Yes									●	●	●	
		S01715	15°	0,17	Yes									●	●	●	
		S02020	20°	0,20	Yes												●
T02020	20°	0,20	No		●	●											
Wiper Sharp Edge	<b>LFW</b>	Sharp Edge	0°	0	No		●										
With Chipbreaker	<b>N-FV</b>	—	0°	0	Yes	●		●	●	●	●	●	●	●	●	●	●
	<b>N-LV</b>	S00535	35°	0,05	Yes	●		●	●	●	●	●	●	●	●	●	●
	<b>N-SV</b>	S01235	35°	0,12	Yes			●	●	●	●	●	●	●	●	●	●

### Cutting Edge Specification Identification Code

Notation of Edge Preparation			
No.	Standard Type		
L	Low cutting forces	F	Sharp edge
E		E	Honing
E	High efficiency	T	Negative land
H		S	Negative land + honing
WG / WH / W	Wiper		
N-FV / N-LV / N-SV	With Chipbreaker		

### Edge Preparation Identification Code

**S 0 1 2 2 5**

W: Negative land width     $\alpha$ : Negative land angle

Cutting edge: T - Negative land  
S - Negative land + R - Honing

Example: **S01225**  
→ 25°/0,12 mm width negative land with honing

## Insert Types and Cutting Edge Geometries

### Multi Cornered One-Use Type Inserts

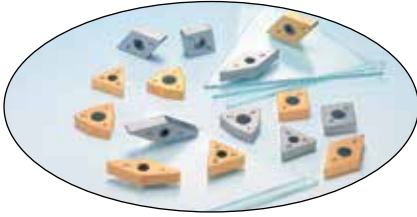

#### ■ Characteristics

- One-use type inserts improve machining efficiency by using each cutting edge to its full potential following the numbering system on each cutting edge then throwing the insert away.
- Multi cornered inserts have a single piece of Sumiboron mounted on every useable corner. Single sided inserts use the top corners whilst double sided inserts use both top and bottom corners. Diamond shaped inserts have 4 corners and triangular inserts have 6 corners.
- A variety of Sumiboron coated grades readily replace expensive grinding operations for high precision tolerances outstanding surface finish, heavy interrupted cutting and efficient cost effective machining of hardened parts.

### Cutting Edge Preparation

#### Machining of Hardened Steel

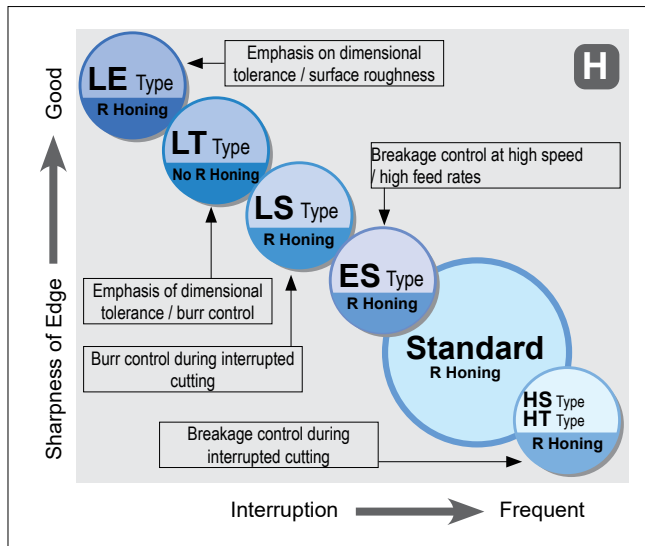

#### Sintered Alloy Machining

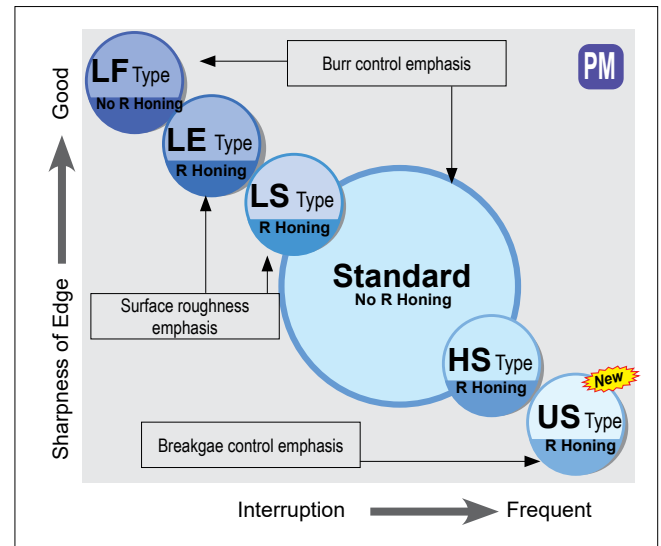

### One-Use Wiper Insert



#### ■ Characteristics

- New lineup includes:
  - WG Type** ⇨ for low-feed cutting
  - WH Type** ⇨ for high-feed cutting
- SUMIBORON one-use insert with wiper edge for hardened steel machining
- Excellent surface finish similar to grinding
- Improved efficiency with higher speeds and feeds

### Break Master N - FV, N - LV, N - SV

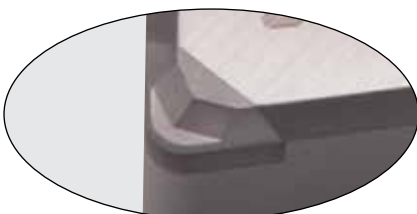

Break Master N-SV Type

#### ■ Characteristics

- N-SV type is perfect for carburised layer removal while N-FV / N-LV types are best suited to finishing of hardened steel.
- First CBN insert to feature an integral chipbreaker
- Ideal for removing carburised layer - can be used on both hardened and unhardened materials.
- Effective chip control solution protects component from swarf damage.

# SUMIBORON Break Master N-FV /N-LV /N-SV

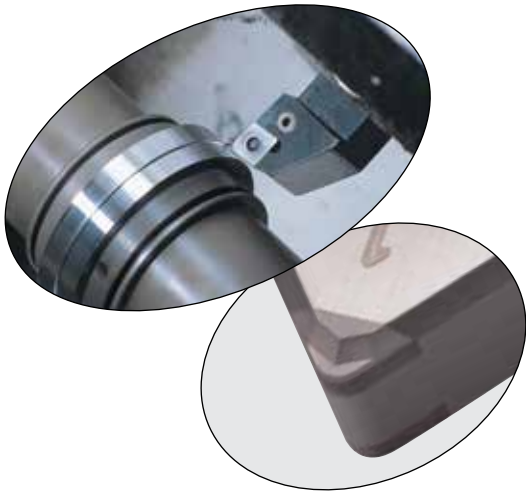

## ■ Characteristics

- SUMIBORON one-use insert with chipbreaker.
- N-SV type is perfect for carburised layer removal while N-FV/N-LV types are best suited to finishing of hardened steel.
- Breaker included on the CBN edge, chipbreaking effect can be maintained throughout machining process.
- Unique breaker design can be applied to both hardened and non-hardened parts with effective chip control.

## ■ Application Range

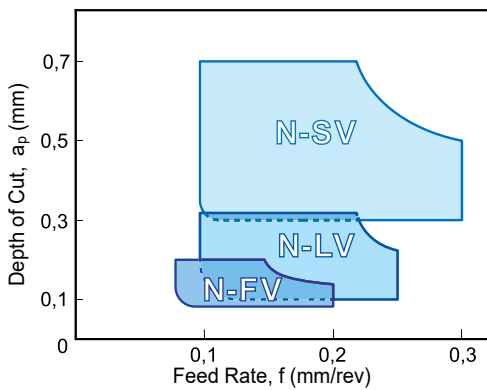

N-SV



### N-SV For Carburised Layer Removal

Ideal for carburised layer removal.

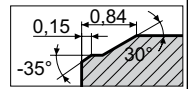

N-LV

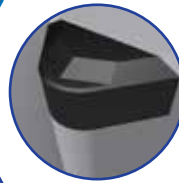

### N-LV For Light Cutting

Excellent chip evacuation under conditions with depth of cut at  $\leq 0,3$  mm.

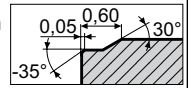

N-FV

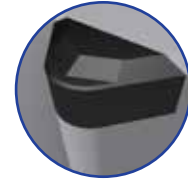

### N-FV For Finishing

Excellent chip evacuation under finishing conditions with depth of cut at  $\leq 0,2$  mm.

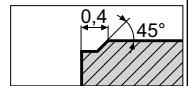

## ■ Application Examples

External Carburised Layer Removal	
<p>No constant stopages or incorrect part dimension problem and the chips are small.</p> <p>Double the tool life of competitor's CBN</p> <p>Work material: 42CrMo4, Carburised steel (shaft)                      Insert: CNGG 120408 N-SV NC4 (BNC200)                      Conditions: <math>v_c = 150</math> m/min, <math>f = 0,15</math> mm/rev, <math>a_p = 0,5</math>mm, x 2 passes, wet</p>	<p>Break Master N-SV Tool life = 200 pcs</p>
	<p>BNC200 (no breaker) Tool life = 200 pcs</p>
	<p>Comp. CBN (no breaker) Tool life = 100 pcs</p>

Carburised Face Layer Removal	
<p>Break Master N-SV type improves chip control with increased productivity until the pre-set tool life.</p>	<p>Break Master N-SV: No chip control problem</p> <p>No breaker: Constant chip control problem</p> <p>No. of pcs / unit of time (relative)</p>
	<p>Work material: 42CrMo4 (HRC30-62)                      Insert: CNGG 120408 N-SV NC4 (BNC200)                      Conditions: <math>v_c = 140</math> m/min, <math>f = 0,15</math> mm/rev, <math>a_p = 0,3</math> mm, wet</p>



### ■ Characteristics

- SUMIBORON one-use insert with wiper edge for hardened steel machining
- Excellent surface finish similar to grinding
- Improved efficiency with higher speeds and feeds
- New lineup includes:
  - WG** type ⇨ for low-feed cutting
  - WH** type ⇨ for high-feed cutting



### ■ Application Range

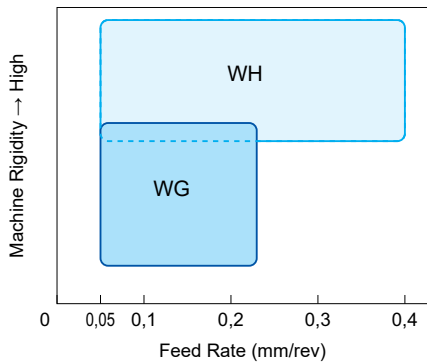

- WH** type:  
→ for high-rigidity workpieces and equipment
- WG** type:  
→ for issues of undulation or chatter

### ■ Finished Surface Roughness

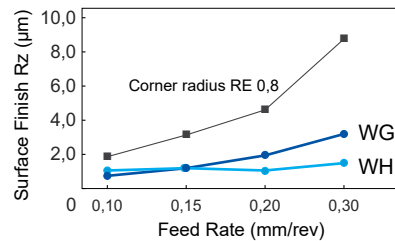

The wiper insert offers good finished surface roughness and improved machining efficiency.

Work Material: 15CrMo5 (60 HRC)  
Insert: CNGA120408NC4  
Cutting Data:  $v_c = 135$  m/min,  $a_p = 0,1$  mm, dry

### ■ Wiper Insert Operation

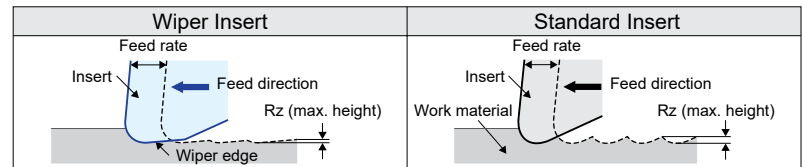

### ■ Tool-Setup WG / WH Wiper

#### CNGA / CCGW / WNGA Type Wiper

1. Use a holder with a 95° approach angle.
2. Tool compensation required.

CNGA / CCGW / WNGA type wiper inserts do not follow the ISO standard. Correction of the tool offset of the cutting edge as explained on the right.

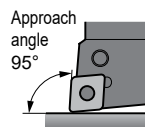

#### Cutting Edge Position Compensation, Outer Processing

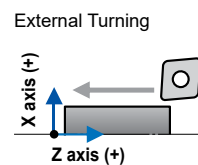

Nose Radius	Type	X-Direction	Z-Direction
RE 0,4	WG	-0,02	-0,02
	WH	-0,06	-0,06
RE 0,8/1,2	WG	-0,01	-0,01
	WH	-0,06	-0,06

#### DNGA / DCGW Type Wiper

1. Use a holder with a 93° approach angle.
2. Tool compensation required.

DNGA / DCGW type wiper inserts do not follow the ISO standard. Correction of the tool offset of the cutting edge as explained on the right.

Note: DNGA/DCGW type wiper inserts are only possible for external and internal turning, not for facing.

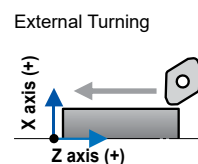
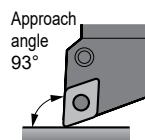

#### Cutting Edge Position Compensation, Outer Processing

Nose Radius	Type	X-Direction	Z-Direction
RE 0,4	WG	-0,17	-0,01
	WH	-0,70	-0,06
RE 0,8	WG	-0,05	0
	WH	-0,58	-0,05

# Uncoated SUMIBORON BN1000/BN2000

**H** Hardened Steel

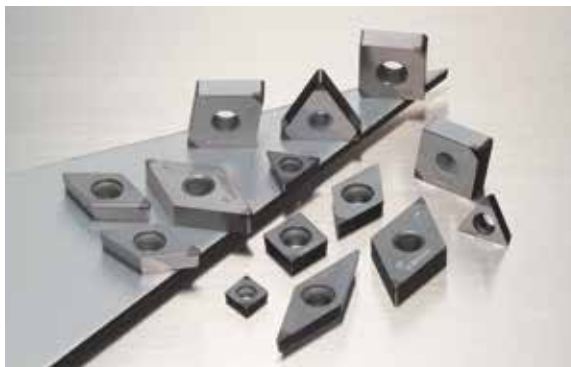

## Uncoated CBN grades for hardened steel machining

### General Features

A new uncoated type of SUMIBORON that has a newly developed high-purity ceramic binder.

Both fracture and wear resistance are combined to achieve a stable tool life in a wide variety of hardened steel machining.

Available in single corner and multi-corner type inserts.

### Characteristics

- BN1000** - Superior high-speed machining grade with the highest wear resistance of any uncoated SUMIBORON. Delivers excellent tool life in continuous cutting to light-interrupted cutting.
  - Improved fracture resistance while also emphasizing wear resistance.
  - Improved hardness and heat resistance from the high-purity TiCN ceramic binder.
- BN2000** - General purpose grade suitable for typical hardened steel machining applications. Provides stable tool life in everything from continuous cutting to light-to-medium interrupted cutting.
  - High degrees of both fracture resistance and wear resistance.
  - Significant improvements in the performance of both by employing a high-purity ceramic binder.
  - Stable surface roughness by increasing sharpness (Figure on right).

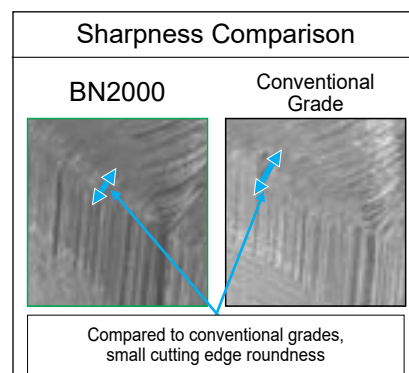

### Newly Developed High-Purity Ceramic Binder

Conventional Grade

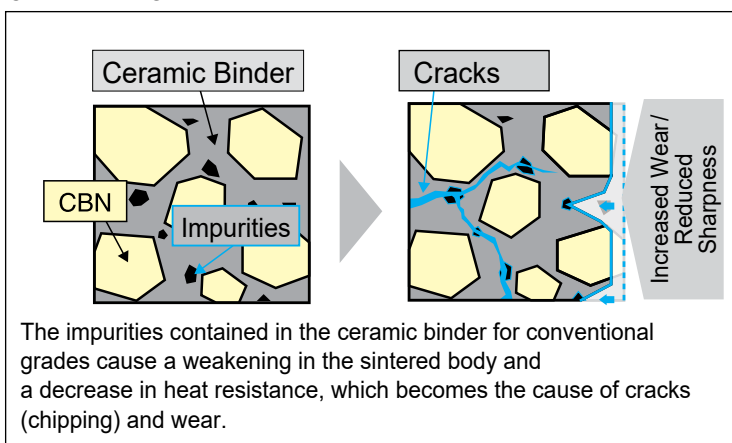

BN1000/BN2000

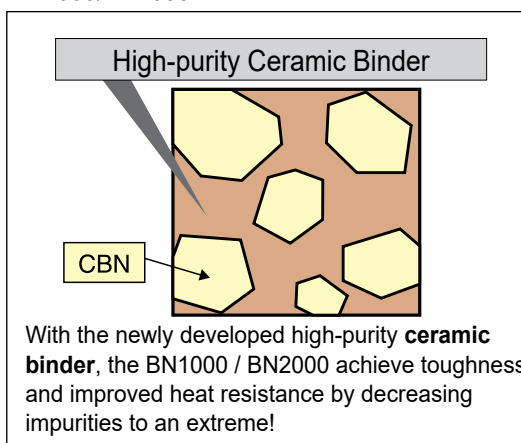

### Recommended Application Range

Continuous Cutting

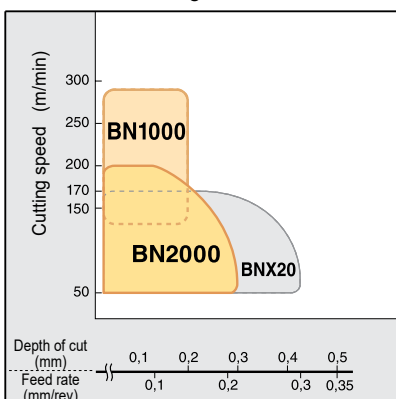

Interrupted Cutting

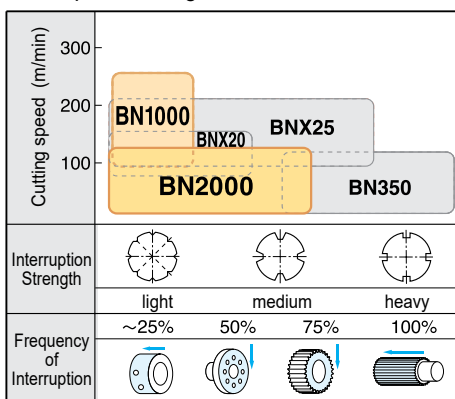

### Cutting Conditions

BN1000

$v_c$ (m/min)	$f$ (mm/rev)	$a_p$ (mm)
100 150 200 250 300		
120	0,03–0,15	0,03–0,2

BN2000

$v_c$ (m/min)	$f$ (mm/rev)	$a_p$ (mm)
50 100 150 200 250		
80 120	0,03–0,2	0,0–0,3

\* Coolant ... Continuous cutting: dry or wet  
Interrupted cutting: dry



**■ Cutting Performance**

BN1000

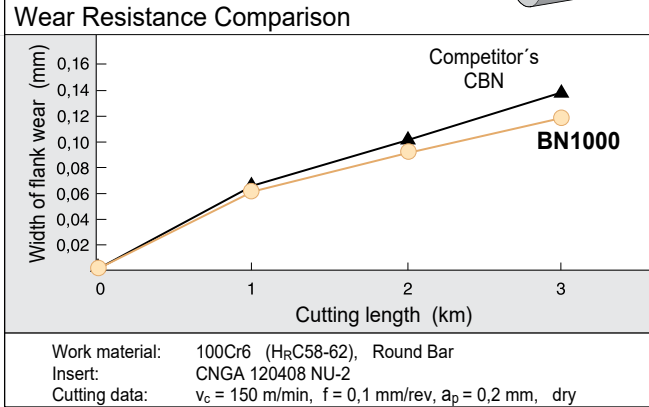

BN1000

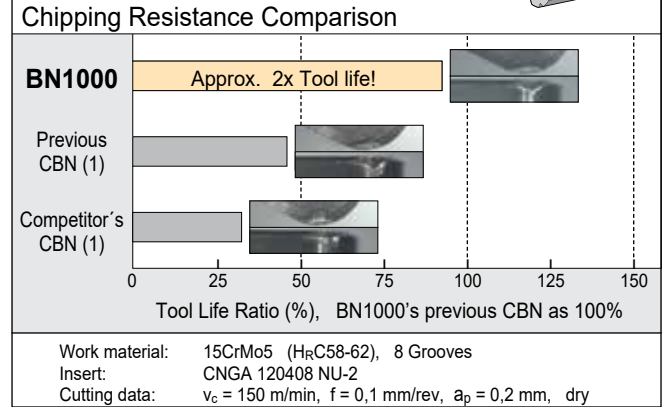

BN2000

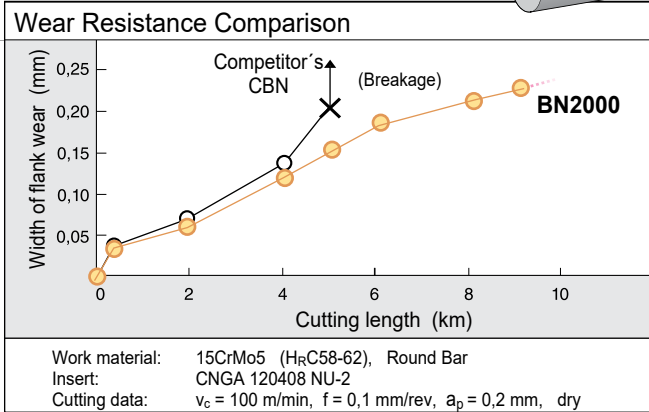

BN2000

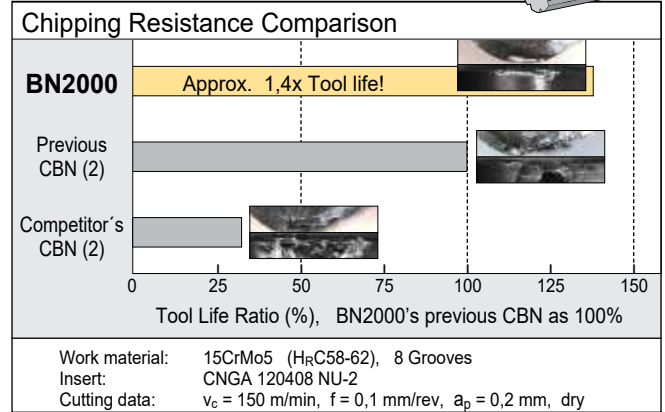

**■ Machining Precision**

BN1000

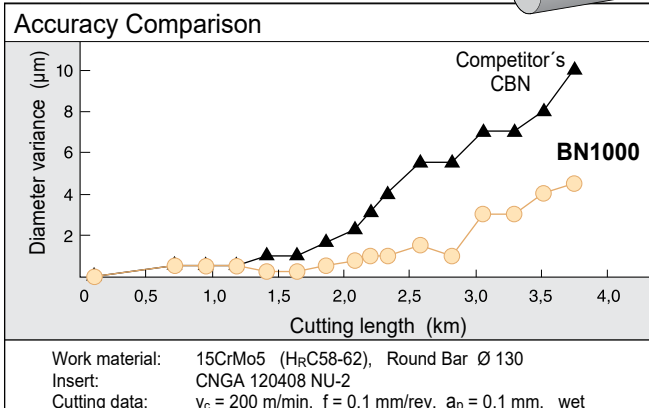

BN2000

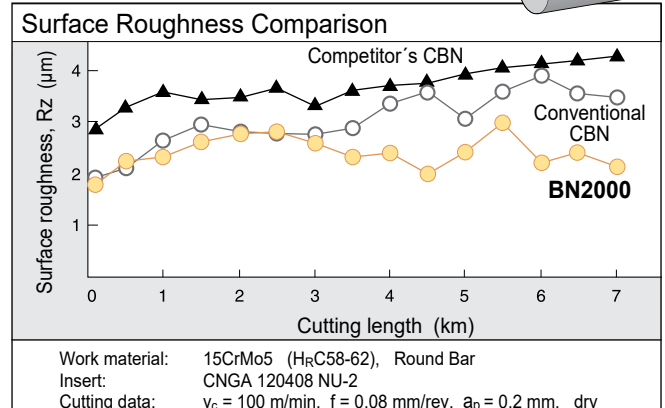





General Features

BNC2115/BNC2125 have been added to our coated SUMIBORON series and are our first recommendations for hardened steel machining, for even higher efficiency machining. It's the pinnacle of high accuracy and high efficiency cutting. In combination with BNC2010/BNC2020, which emphasize stable tool life, they improve productivity in all kinds of hardened steel machining.

Features

BNC2115

New

- The definitive grade in high-accuracy machining. Realises long tool life with excellent surface roughness and stable machining.
- Further maintains excellent surface roughness. Maintains excellent surface roughness thanks to a coating with high notch wear resistance and tough CBN substrate.

BNC2125

New

- First recommendation for hardened steel machining. Superb wear and fracture resistance.
- Achieves long, stable tool life even in high-efficiency and interrupted machining. Along with a tough CBN substrate, the coating combines wear resistance and toughness to realise stable machining.

BNC2010

- Grade for high-precision machining with excellent surface roughness and finished surface accuracy. Grade ideal for high-precision machining, with highly wear-resistant CBN substrate and coating.

BNC2020

- General-purpose grade suitable for typical hardened steel machining applications. Achieves further stability in machining of a wide range of hardened steel components.

Application Range

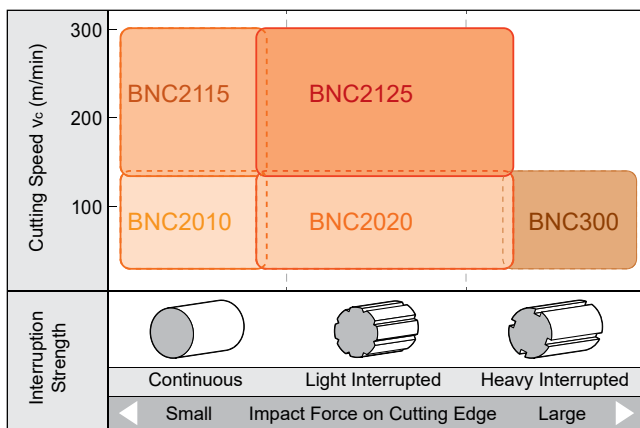

Differentiation

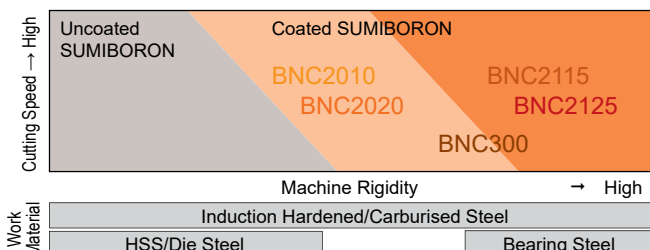

# BNC2115/BNC2125/BNC2010/BNC2020



## CBN Substrate und Coating Structure

### BNC2115

High-Precision Machining  
(Medium- to high-speed)

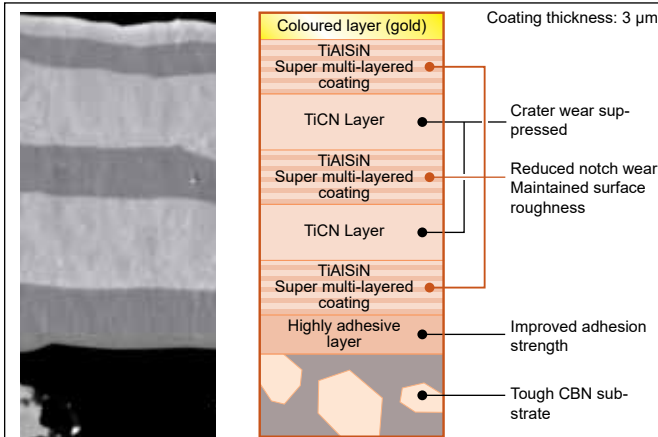

Thick layer of laminated high-strength TiAlSiN super multi-layered coating and highly heat-resistant TiCN coating. Achieves excellent surface finish quality with application to a tough substrate.

### BNC2125

General Machining  
(Medium- to high-speed)

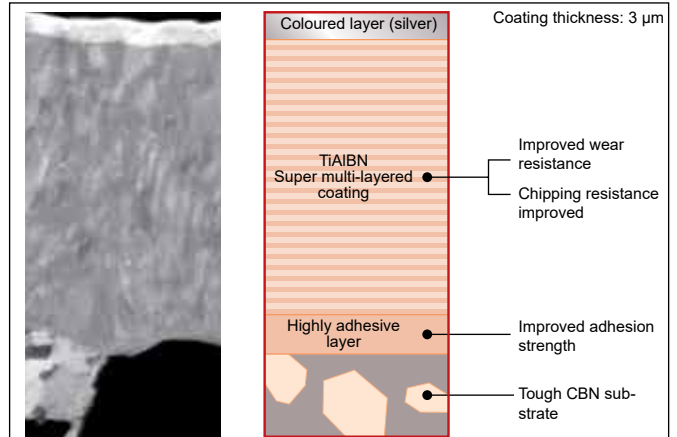

Thick layer of super-multilayered ultra-fine TiAlBN coating with high strength and high hardness. High performance in a wide range of cutting through application to a tough substrate.

### BNC2010

High-Precision Machining  
(Low- to medium-speed)

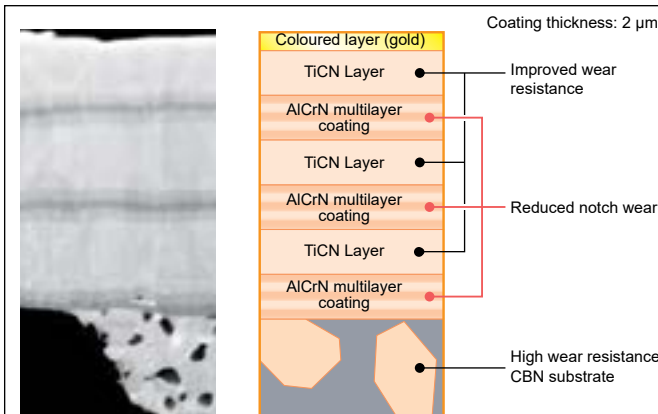

Laminated high-strength AlCrN multi-layered coating and highly heat-resistant TiCN coating is applied to a highly wear-resistant substrate to maintain excellent surface finish quality.

### BNC2020

General Purpose Machining  
(Low to medium speed, unstable cutting)

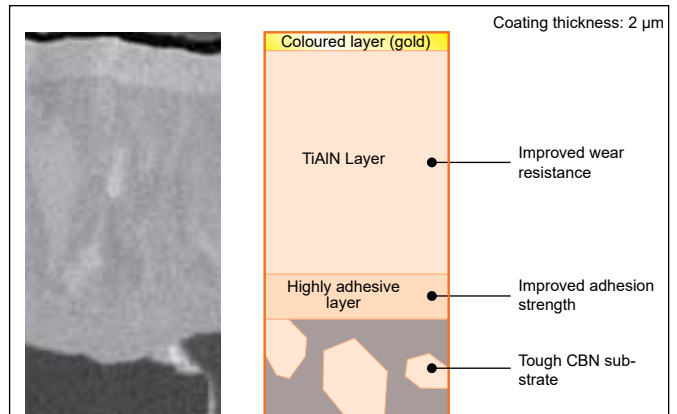

Application of highly wear-resistant TiAlN coating to a tough substrate. Machining stability in low-rigidity environments and high-load cutting is dramatically improved.

## Recommended Cutting Conditions

Grade	Cutting Speed $v_c$ (m/min)		Feed Rate $f$ (mm/rev)		Depth of Cut $a_p$ (mm)	
	Min.	Optimum–Max.	Min.	Optimum–Max.	Min.	Optimum–Max.
BNC2115	110	180–300	0,03	0,10–0,20	0,03	0,20–0,35
BNC2125	110	160–300	0,05	0,20–0,40	0,05	0,30–0,50
BNC2010	50	140–180	0,03	0,10–0,20	0,03	0,20–0,35
BNC2020	50	120–180	0,03	0,20–0,40	0,05	0,30–0,50
BNC300	50	100–150	0,03	0,10–0,20	0,03	0,20–0,30

# Coated SUMIBORON BNC2115/BNC2125/BNC2010/BNC2020

## ■ Cutting Performance

### BNC2115

#### Continuous Cutting, Wear Resistance

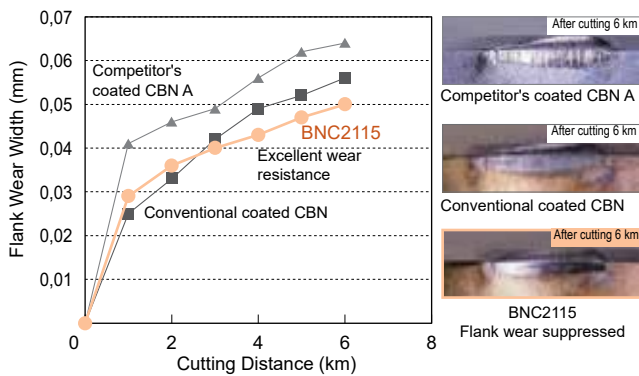

Work Material: 16CrMo4 (58–62 HRC)  
Insert: DNGA150408NC4  
Cutting Data:  $v_c = 200$  m/min,  $f = 0,1$  mm/rev,  $a_p = 0,15$  mm, wet

#### Continuous Cutting, Machined Surface Roughness

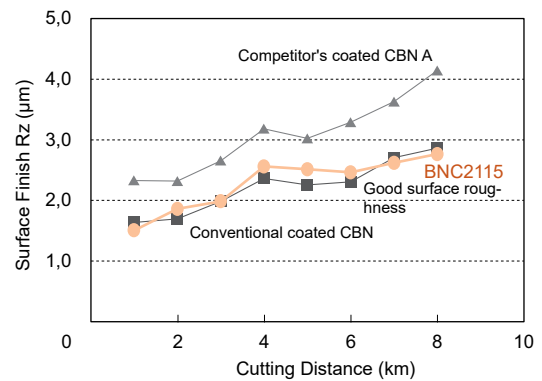

Work Material: 16CrMo4 (58–62 HRC)  
Insert: DNGA150408NC4  
Cutting Data:  $v_c = 200$  m/min,  $f = 0,1$  mm/rev,  $a_p = 0,15$  mm, wet

### BNC2125

#### Continuous Cutting, Wear Resistance

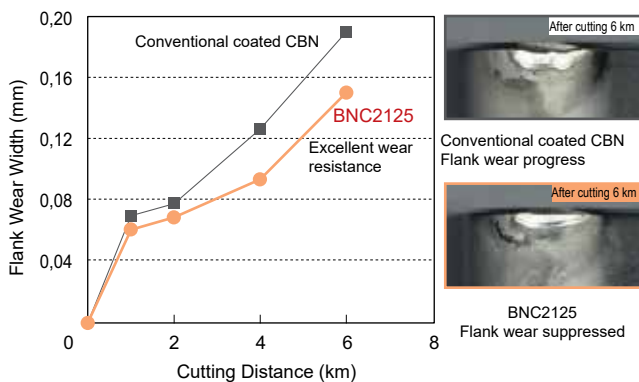

Work Material: 100Cr6 (58–62 HRC)  
Insert: DNGA150408NC4  
Cutting Data:  $v_c = 150$  m/min,  $f = 0,1$  mm/rev,  $a_p = 0,2$  mm, wet

#### High-Load Cutting, Fracture Resistance

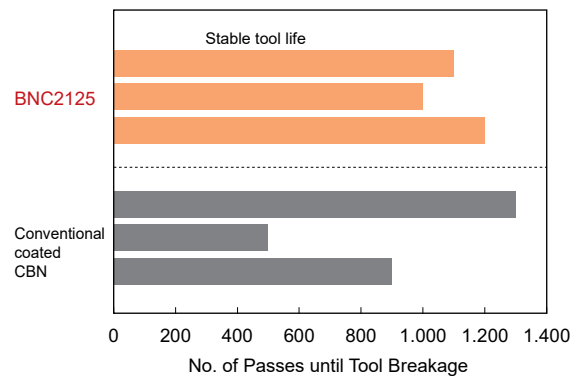

Work Material: 100Cr6 (58–62 HRC)  
Insert: DNGA150408NC4  
Cutting Data:  $v_c = 150$  m/min,  $f = 0,15$  mm/rev,  $a_p = 0,5$  mm, 63 m/times, wet

### BNC2010

#### Continuous Cutting, Machined Surface Roughness

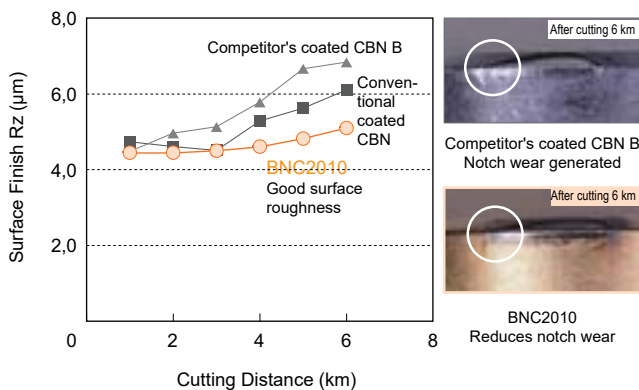

Work Material: 16CrMo4 (58–62 HRC)  
Insert: DNGA150408NC4  
Cutting Data:  $v_c = 120$  m/min,  $f = 0,14$  mm/rev,  $a_p = 0,15$  mm, wet

### BNC2020

#### Interrupted Cutting, Fracture Resistance

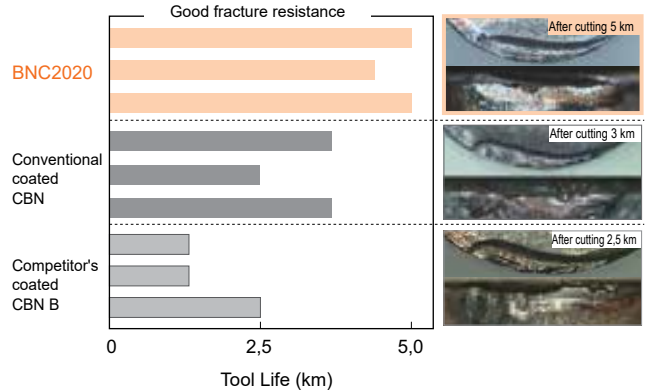

Work Material: 16CrMo4 with 5 grooves (58–62 HRC)  
Insert: DNGA1204012NC4  
Cutting Data:  $v_c = 130$  m/min,  $f = 0,1$  mm/rev,  $a_p = 0,6$  mm, dry

The ultimate grades BNC300 and BN350 in interrupted machining of hardened steel

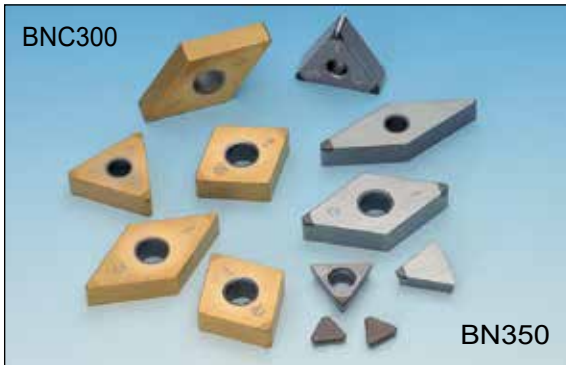

■ General Features

- **BNC300**  
CBN substrate that emphasizes on toughness coupled with a highly wear resistant TiAlN based coating layer that has improved adhesion strength. With a good balance of fracture and wear resistance, stable and longer tool life can be achieved in interrupted cut or in a mixture of continuous and interrupted cutting.
- **BN350**  
SUMIBORON series highest fracture resistance and toughest CBN. Reliable grade for achieving stable tool life in heavy interrupted cutting conditions.

■ Characteristics

- BNC300**
- Stable and long tool life in interrupted cutting  
Achieving stable and long tool life in heavy interrupted cutting, with superior fracture resistance.
  - Superior dimensional precision  
Good adhesion strength, TiAlN based, high wear resistance coating. Achieving superior dimensional precision even in interrupted cutting.
  - Suitable for different types of workpieces  
Achieving significantly longer tool life even on workpieces that have a mixture of continuous and interrupted cutting.
- BN350**
- Stable and long tool life in interrupted cutting  
Stable and long tool life with superior fracture resistance, that prevents fractures which commonly occurs during interrupted cutting.

■ Performance

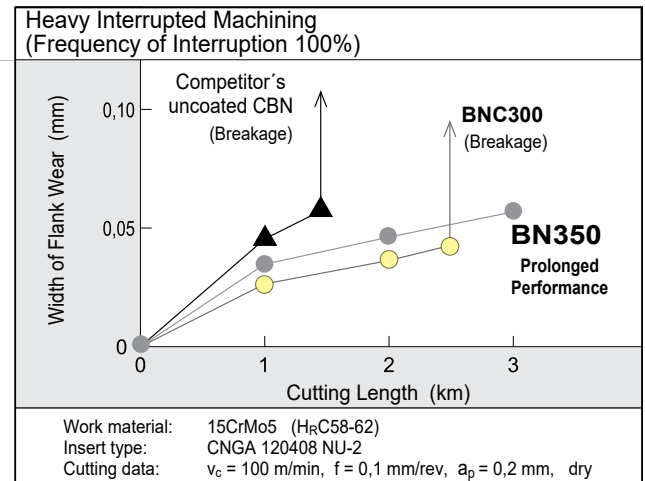
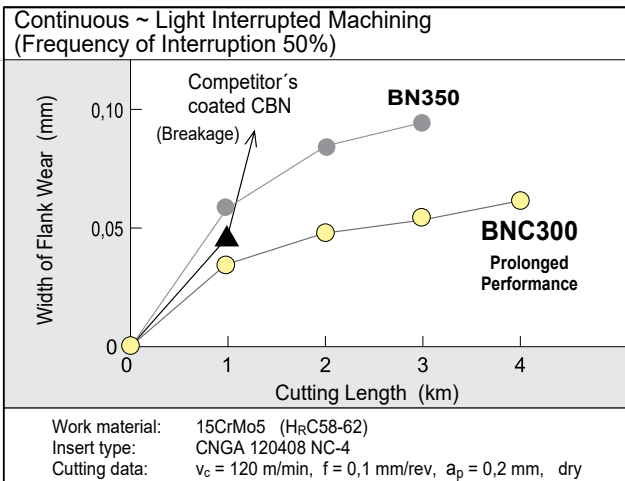

■ Recommended Application Range

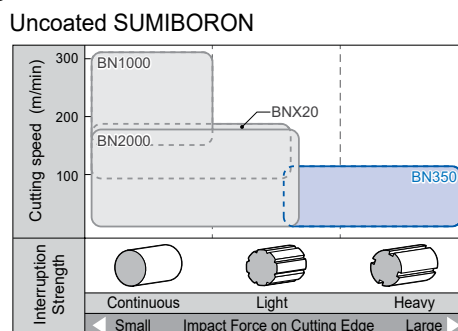
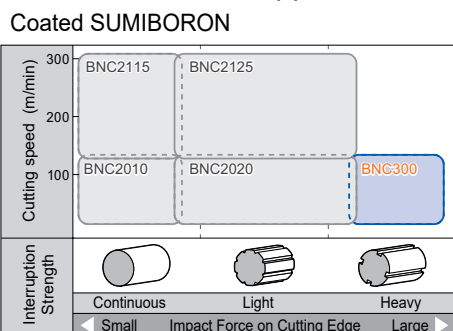

■ Recommended Cutting Conditions (BNC300, BN350)

$v_c$ (m/min)	$f$ (mm/rev)	$d_{oc}$ (mm)
50	80	0,03-0,3
100	120	0,03-0,3
150		
200		

Coolant ... Interrupted cutting: dry

**BN7000** **K** **PM** / **BN7115** **PM**

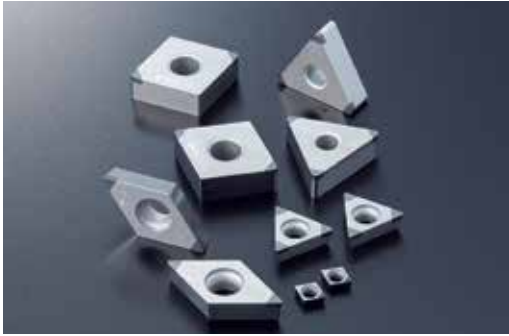

■ General Features

Good wear resistance through high CBN content also delivers superior fracture resistance by increasing the binding strength between CBN particles. BN7115 provides stable performance for high-speed finishing work and is ideal for finishing of sintered alloys.

New cutting edge treatment with an emphasis on fracture resistance: "US" type chipbreaker now available.

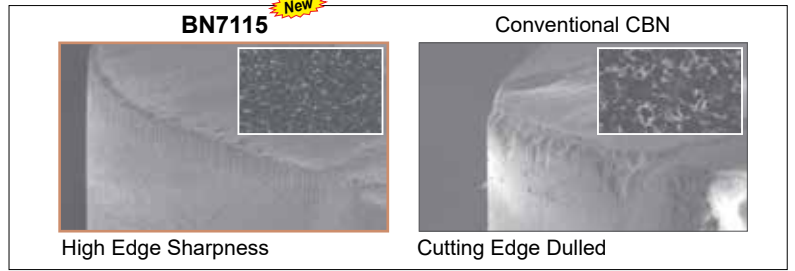

Removal of binder → comparison of CBN particles' binding strength

■ Features

- BN7000**
  - Achieves high-efficiency machining of sintered alloys of various shapes with a standard and two types of cutting edge variations. Also exhibits high performance for difficult-to-cut materials such as rolls, high speed steel and heat resistive alloys. Exhibits good thermal resistance in high-speed machining of cast iron.
- BN7115** **New**
  - With improved CBN particle/binder boundary strength due to the special binder and improved binding strength between CBN particles thanks to our proprietary sintering process, the edge sharpness in sintered alloy machining is excellent and burrs and tearing are suppressed.

■ Application Range

- Sintered Alloy (50–95 HRB/90–200 HV)

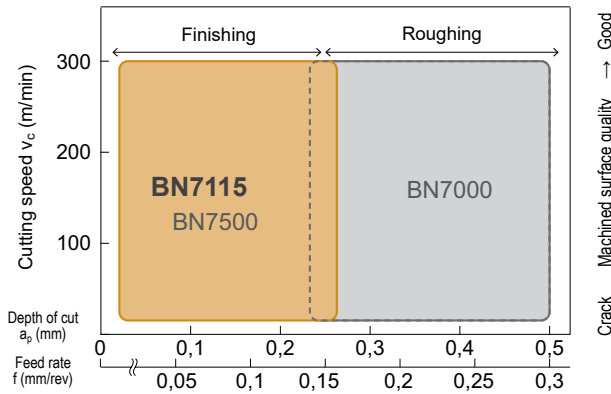

■ Recommended Cutting Conditions

- Cast Iron **K**

Work material	Grade	Cutting conditions (min.–optimum–max.)		
		Cutting speed $v_c$ (m/min)	Feed rate $f$ (mm/rev)	Depth of cut $a_p$ (mm)
Cast Iron	<b>BN7000</b>	100–1,000–2,500	0,05–0,30–0,60	0,05–0,50–1,00

- Sintered Alloy **Sintered Alloy**

Work material	Grade	Cutting conditions (min.–optimum–max.)		
		Cutting speed $v_c$ (m/min)	Feed rate $f$ (mm/rev)	Depth of cut $a_p$ (mm)
General sintered alloy	<b>BN7115</b>	10–150–300	0,01–0,08–0,15	0,05–0,13–0,25
	BN7000	10–150–300	0,01–0,15–0,30	0,05–0,25–0,50
High-density sintered alloy	<b>BN7115</b>	10–100–200	0,01–0,06–0,12	0,05–0,10–0,20
	BN7000	10–100–200	0,01–0,15–0,30	0,05–0,25–0,50

■ Recommended Edge Treatment

**BN7000**

● Negative Land

Type	$\alpha$	w (mm)	Honing
Standard	15°	0,12	No
LF	–	–	No
HS	25°	0,12	Yes

Round honed cutting edge

**BN7115**

Type	$\alpha^\circ$	W (mm)	Honing
Standard	15°	0,12	no
LF	Standard edge		no
LE	Standard edge		yes
LS	15°	0,07	yes
HS	25°	0,05	yes
US	25°	0,12	yes

Frequency of interruption → Heavy

New US type emphasises fracture resistance, ideal for heavy interrupted cutting.



■ Cutting Performance (Cast Iron)

● BN7000 Continuous Cutting (Flank Wear)

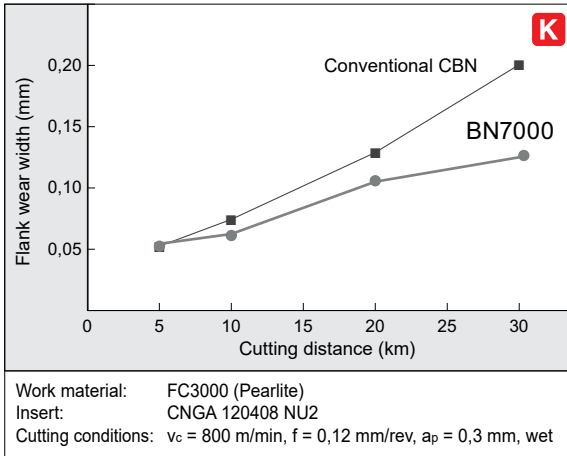

■ Cutting Performance (Sintered Alloy)

● BN7115 Continuous Cutting (Surface Roughness)

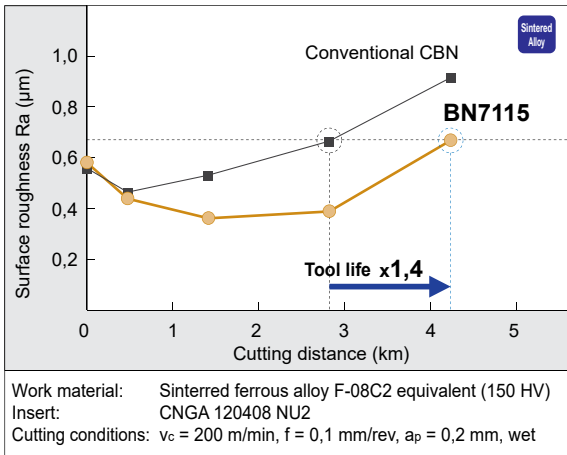

● BN7115 Continuous Cutting (Wear Resistance)

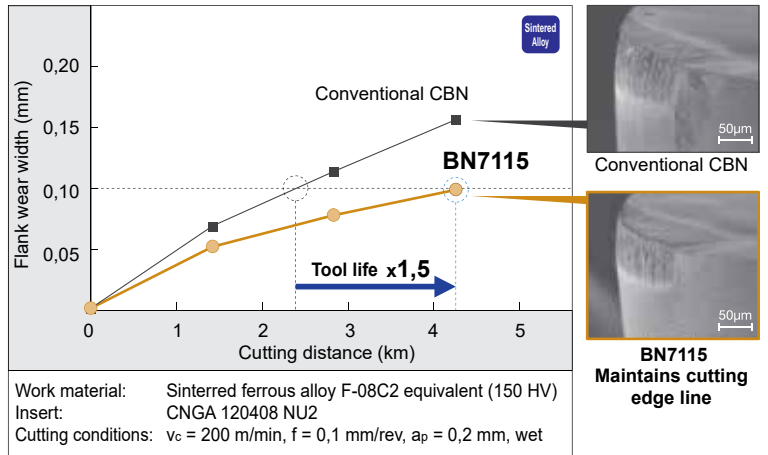

● BN7115 Interrupted Cutting (Fracture Resistance)

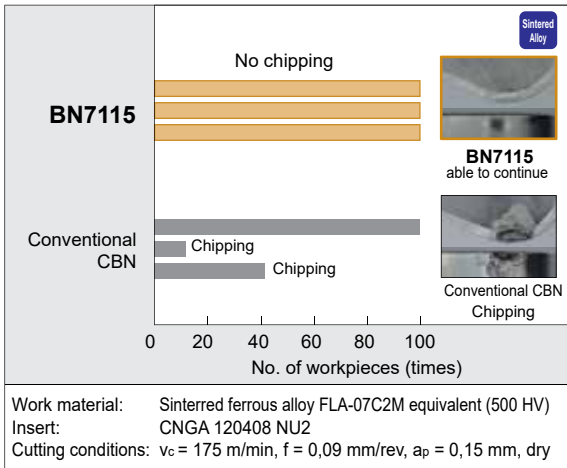

● BN7000 Interrupted Cutting (Fracture Resistance)

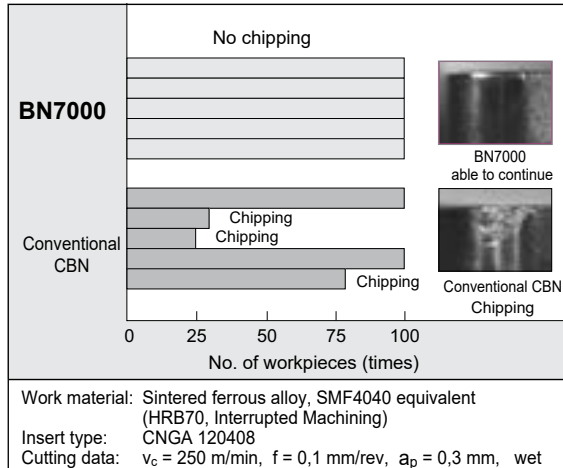





## General Features

Enables a wide range of machining from roughing to finishing of cast iron, exotic alloy cast iron and hardened steel.  
100% solid CBN structure enables depth-of-cut of 0,5 mm and above.

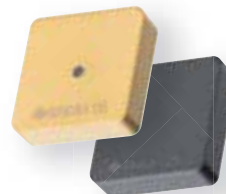

## Features

**BNC8115** New ● PVD coating with excellent wear resistance suppresses flank wear when machining difficult-to-cut cast iron and hardened steel. Ideal for roughing and depth-of-cut of 0,5 to 3,0 mm. Can also be used for roughing and finishing of grey cast iron. Gold-colored coating improves visibility of used corners.

**BNS8125** New ● Optimising the particle size distribution of the CBN particles has resulted in improved chipping resistance and longer life while machining wear resistance during grey cast iron machining.

## Application Range

### ● Grey Cast Iron

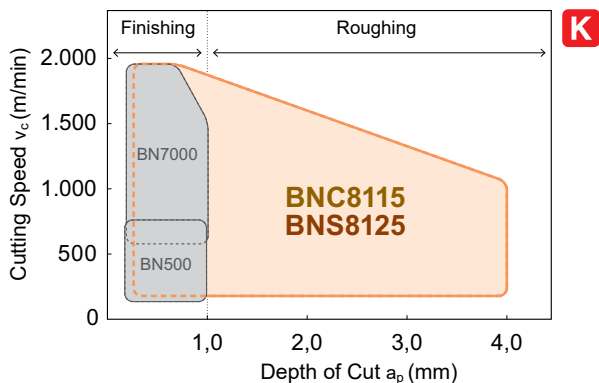

Wet machining is recommended for grey cast iron. In case of dry machining, our 1st recommendation are BNC8115/ BNS8125 for both roughing and finishing.

### ● Ductile Cast Iron

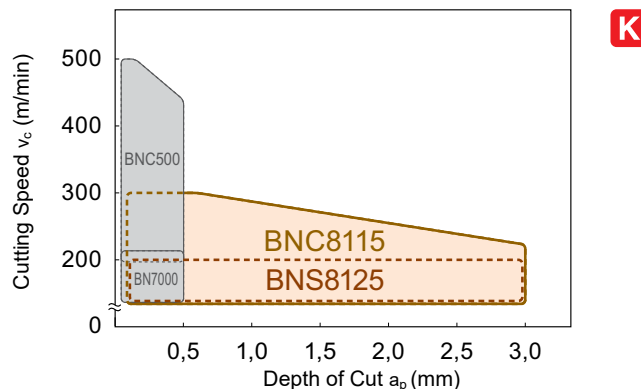

### ● Hardened Steel

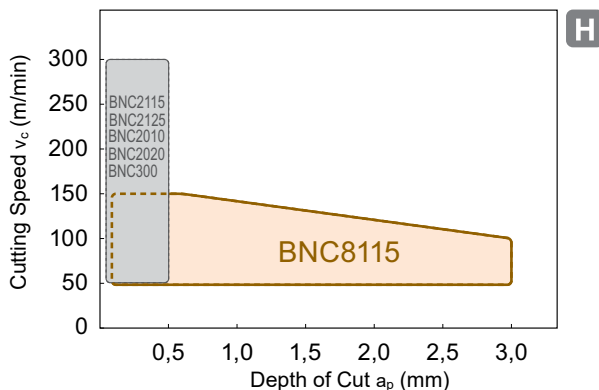

## Recommended Cutting Conditions

### ● Cast Iron (Turning)

Work Material	Grade	Cutting Conditions <span style="float: right;">Min.-Optimum-Max.</span>		
		Cutting Speed $v_c$ (m/min)	Feed Rate $f$ (mm/rev)	Depth of Cut $a_p$ (mm)
Grey Cast Iron	<b>BNC8115</b>	200-1.000-2.000	0,10-0,50-1,00	$\leq 4,0$
	<b>BNS8125</b>	200-1.000-2.000	0,10-0,50-1,00	$\leq 4,0$
Ductile Cast Iron	<b>BNC8115</b>	80-160-300	0,10-0,30-0,50	$\leq 3,0$
	<b>BNS8125</b>	80-120-200	0,10-0,30-0,50	$\leq 3,0$

### ● Hardened Steel (Turning)

Work Material	Grade	Cutting Conditions <span style="float: right;">Min.-Optimum-Max.</span>		
		Cutting Speed $v_c$ (m/min)	Feed Rate $f$ (mm/rev)	Depth of Cut $a_p$ (mm)
Hardened Steel	<b>BNC8115</b>	50-100-150	0,10-0,25-0,40	$\leq 3,0$

### ● Cast Iron (Milling)

Work Material	Grade	Cutting Conditions <span style="float: right;">Min.-Optimum-Max.</span>		
		Cutting Speed (m/min)	Feed Rate (mm/rev)	Depth of Cut (mm)
Grey Cast Iron	<b>BNC8115</b>	800-1.400-2.000	0,10-0,50-1,00	$\leq 4,0$
	<b>BNS8125</b>	800-1.400-2.000	0,10-0,50-1,00	$\leq 4,0$

### ■ BNC8115 Cutting Performance

#### ● Wear Resistance (Ductile Cast Iron Machining) K

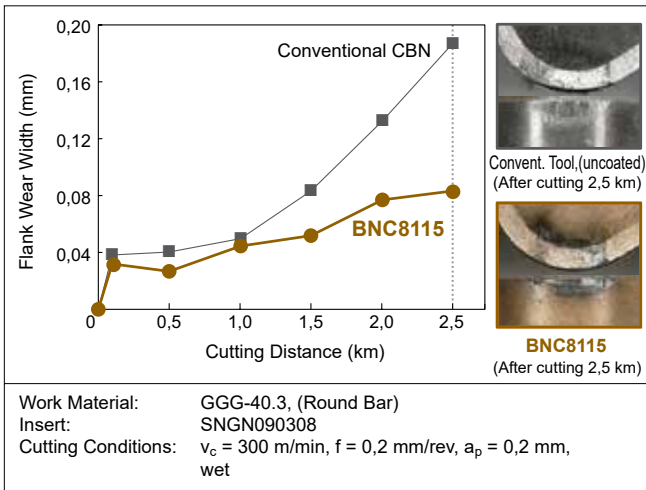

#### ● Wear Resistance (Hardened Steel Machining) H

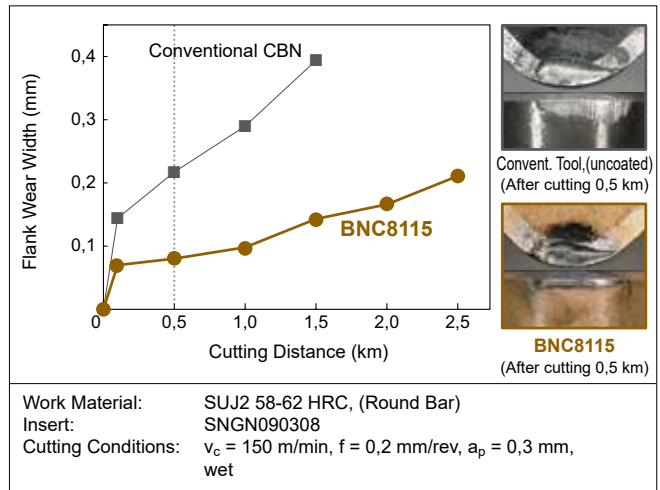

### ■ BNS8125 Cutting Performance

#### ● Wear Resistance (Grey Cast Iron Machining) K

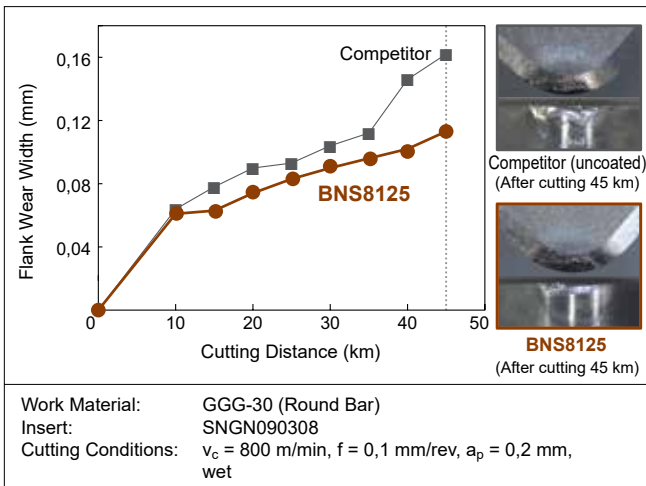

#### ● Fracture Resistance (Ductile Cast Iron Machining) K

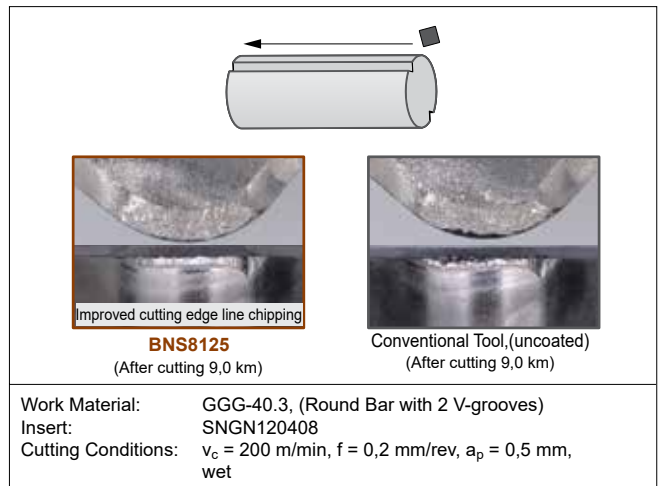

### ■ Choosing between BNC8115 and BNS8125 (Cast Iron/Hardened Steel)

Work Material	Coated SUMIBORON <b>BNC8115</b>		SUMIBORON <b>BNS8125</b>		SUMIBORON <b>BN7000</b>		Coated SUMIBORON <b>BNC500</b>		Coated SUMIBORON <b>BNC2125</b>	
	Turning	Milling	Turning	Milling	Turning	Milling	Turning		Turning	
<span style="border: 1px solid black; padding: 2px;">K</span> Grey Cast Iron	○	Best	○	Best Economical	○	Depth of cut $\leq 1,0$ mm High-speed-finishing	×	Not available	×	Not available
	○	Depth of cut $\geq 0,5$ mm	○	Interrupted machining	○	Depth of cut $\leq 0,5$ mm Low-speed-machining	○	Depth of cut $\leq 0,5$ mm	×	Not available
<span style="border: 1px solid black; padding: 2px;">H</span> Hardened Steel	○	Depth of cut $\geq 0,5$ mm	×	Not available	×	Not available	×	Not available	○	Depth of cut $\leq 0,5$ mm High-speed machining

○ Recommendation      × Not available

## Coated CBN grade for ductile cast iron machining

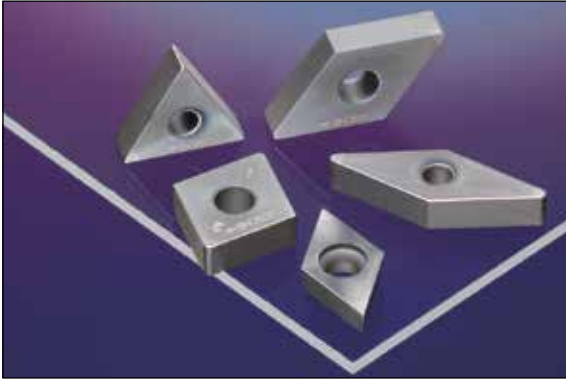

### General Features

Further improvements in the toughness of the sintered CBN and wear resistance from the application of a newly developed high-purity TiC binder. In addition, it demonstrates exceptional wear resistance by combining a ceramic coating with excellent heat resistance. High-speed and high-precision machining is achieved when finishing ductile cast iron. It also provides a long, stable tool life in machining high-strength ductile cast iron, special cast irons such as vermicular cast iron, and centrifugal cast iron.

### Characteristics

- Achieves a Long, Stable Tool Life at  $v_c = 400$  m/min  
Superior wear resistance, makes stable machining possible under high-speed conditions.
- Supports High-precision Machining  
Can maintain excellent dimensional tolerance and surface roughness.

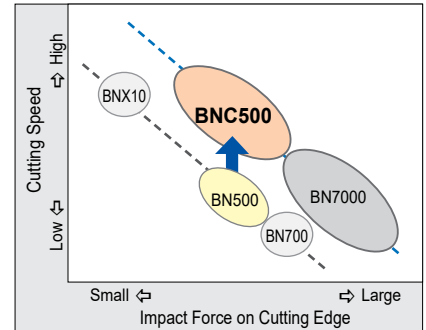

### Cutting Performance

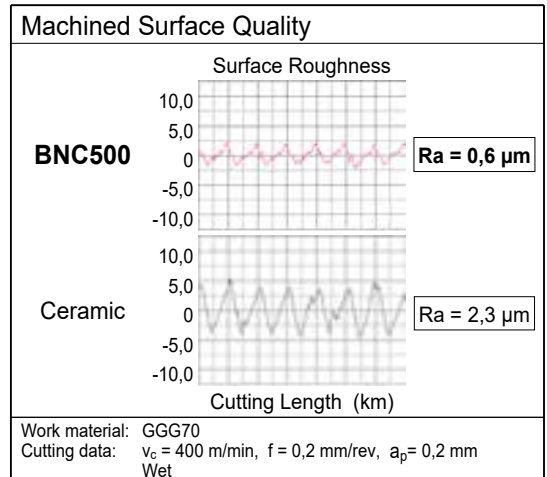
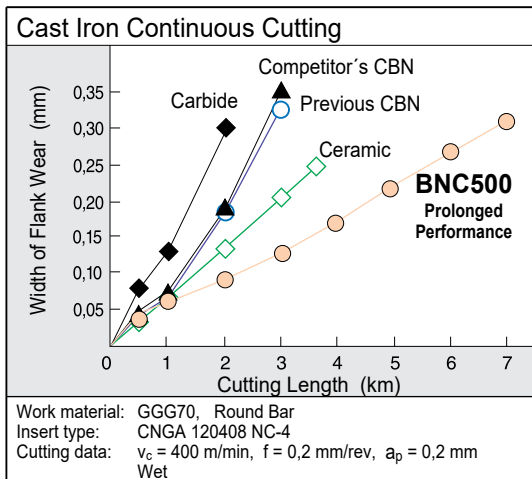

### Application Range

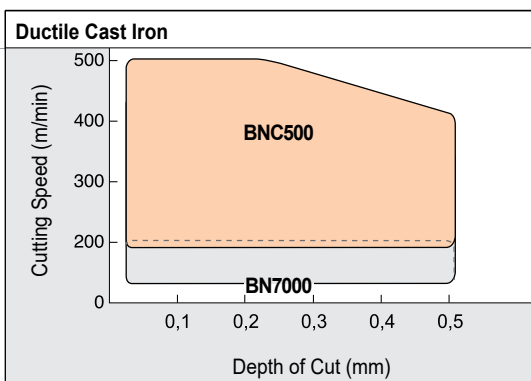

### High Precision Machining

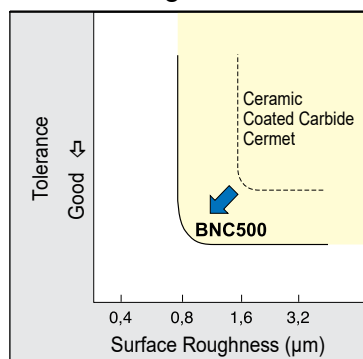

### Recommended Cutting Conditions

$v_c$ (m/min)	
100	200
[Graph showing recommended cutting speed range]	
$f$ (mm/rev)	$a_p$ (mm)
0,1–0,4	0,03–0,5

\* Coolant ... Wet



# SUMIBORON Binderless NCB100

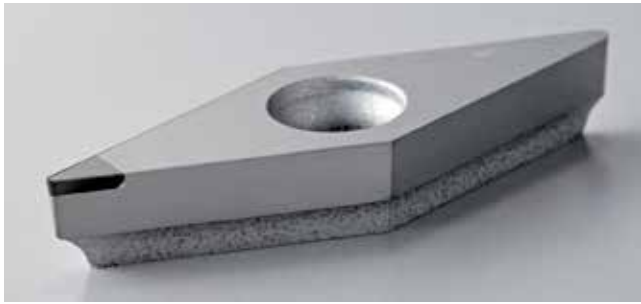

## ■ Features

SUMIBORON Binderless is a polycrystalline cubic boron nitrid (CBN) that directly binds nanometer- or sub-micron-level CBN particles without binder materials.

Binderless CBN is harder and has better thermal conductivity. Therefore, it enables higher efficiency and longer tool life in machining of hard-to-cut materials, such as titanium alloy and cobalt-chromium alloy.

## ■ Mikrostructure of Sintered Body

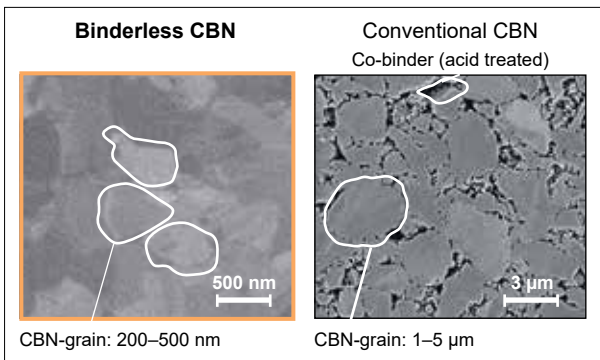

## ■ Physical Properties

	Binderless CBN	Conventional CBN
CBN Content (%)	100	90–95
Binder Material	–	WC–Co
Hardness (GPa)	51–54	41–44
Thermal Conductivity (W/m·K)	180–200	100–120

## SUMIBORON Binderless CBN

### ■ Advantages

- Higher efficient machining and longer tool life have been realized by the effects of higher hardness and thermal conductivity than conventional CBN grades.
- Achieves high precise machining and better surface integrity because of less adhesion by not containing any binder materials.
- Ideal tool material for high-efficient finishing of hard-to-cut materials, such as titanium alloy and cobalt-chromium alloy, cemented carbides and cermets.
- NBC100 is able to maintain excellent dimensional accuracy and surface roughness for a long period.
- Shows improved work efficiency and cost reduction by less frequency of exchanging inserts compared to conventional tool grades.

### ■ Application Range and Performance

Turning of Titanium Alloy (Ti-6Al-4V)

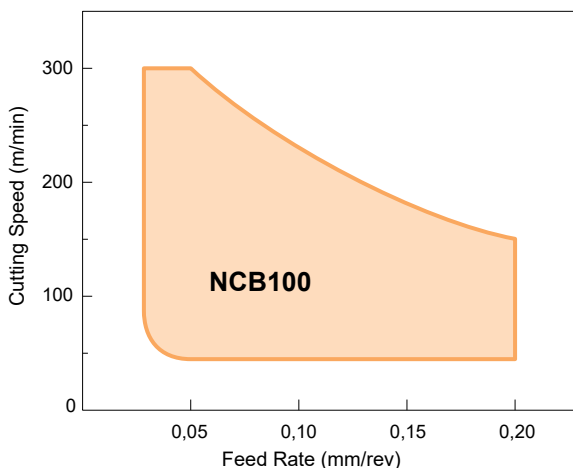

Turning of Cobalt-Chromium Alloy (Co-Cr)

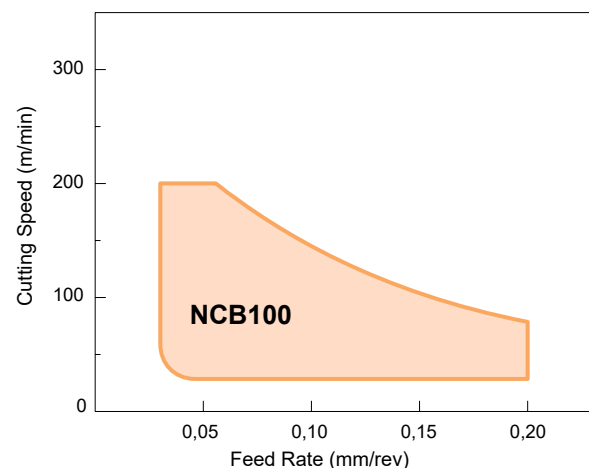

## Turning of Titanium Alloy (Ti-6Al-4V)

### Wear Resistance

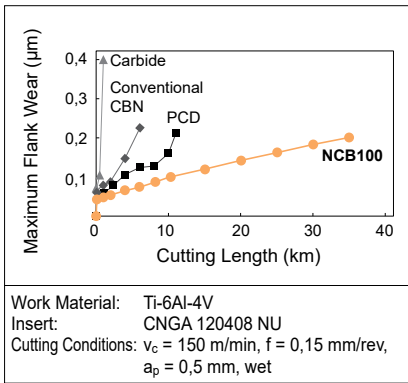

### Surface Roughness

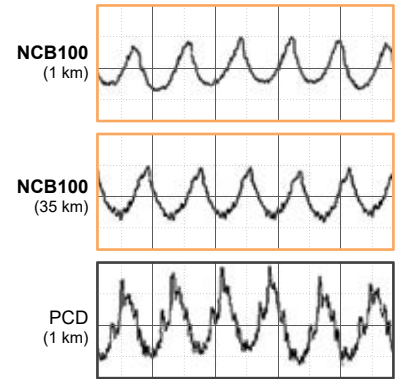
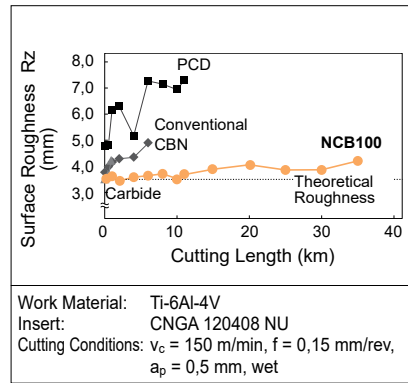

## Turning of Cobalt-Chromium Alloy (Co-Cr)

### Wear Resistance

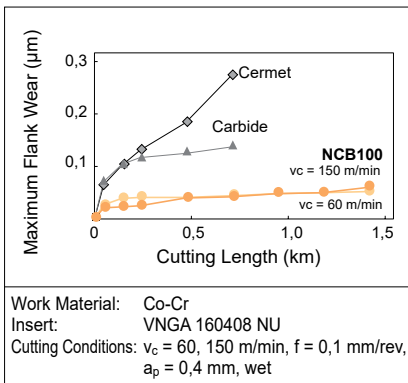

### Surface Roughness

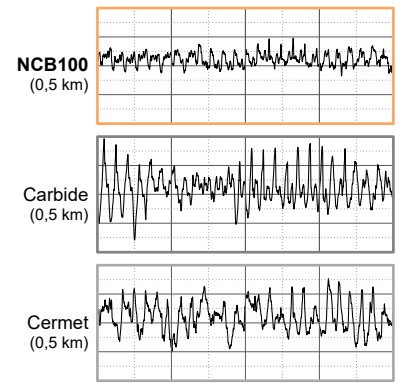
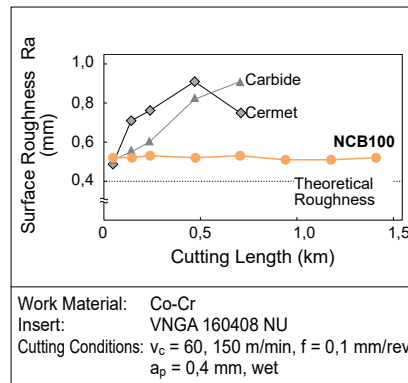

## Recommended Cutting Conditions

### Titanium Alloys

Work Material		Grade	Cutting Conditions		
Composition	Hardness (HRC)		Depth of Cut (mm)	Feed Rate (mm/rev)	Cutting Speed (m/min)
Ti-6Al-4V	30-35	NCB100	0,1-0,3-0,5	0,05-0,15-0,20	50-200-300
Ti-5Al-5V-5Mo-3Cr	32-38	NCB100	0,1-0,3-0,5	0,05-0,10-0,20	50-150-250
Ti-10V-2Fe-3Al	32-38	NCB100	0,1-0,3-0,5	0,05-0,10-0,20	50-150-250

Min. - Optimum - Max.

### Cobalt-Chromium Alloys

Work Material		Grade	Cutting Conditions		
Composition	Hardness (HRC)		Depth of Cut (mm)	Feed Rate (mm/rev)	Cutting Speed (m/min)
Co-30Cr-5Mo	35-45	NCB100	0,10-0,15-0,30	0,05-0,15-0,20	50-200-300

Min. - Optimum - Max.

### Carbides

Work Material		Grade	Cutting Conditions		
Composition	Hardness (HRC)		Depth of Cut (mm)	Feed Rate (mm/rev)	Cutting Speed (m/min)
WC-20Co	<85	NCB100	0,03-0,10-0,20	0,03-0,10-0,20	5-20-40

Min. - Optimum - Max.

SUMIDIA BINDERLESS NPD10 is recommended for: > 85 HRA

### Other Work Materials

Work Material		Grade	Cutting Conditions		
Composition	Hardness (HRC)		Depth of Cut (mm)	Feed Rate (mm/rev)	Cutting Speed (m/min)
Pure Titanium	130-230	NCB100	0,1-0,3-0,5	0,05-0,10-0,20	100-250-400
Cermet	1.000-1.500	NCB100	0,1-0,2-0,3	0,05-0,10-0,20	10-30-50

Min. - Optimum - Max.



# SUMIBORON / SUMIDIA Production Process



## General

Since 1970s, Sumitomo has pioneered the development of sintered cubic boron nitride (CBN) and sintered diamond (PCD) tools successfully used in the tool making industries. These tool materials can be epoch-making in a sense of broadening the cutting application range.

## Production Process

In the production process of **SUMIBORON / SUMIDIA**, CBN powder / diamond powder is firstly synthesized under the ultra - high pressure, and secondly, the synthesized crystalline grains are sintered.

Fig. 2 shows a diagram of high temperature high pressure apparatus for processing the ultra - high pressure sintering operation.

This apparatus is basically composed of a piston and a cylinder to generate ultra - high pressure as high as 5000 N/mm<sup>2</sup> with a special device. The piston and cylinder are made of cemented carbide.

To manufacture final products round discs of SUMIBORON and SUMIDIA material are cut into specific shapes and brazed on to tool bodies made of cemented carbide, or steel, etc., and after that finished by grinding the edge. In another process the final product can be obtained only by cutting blanks and finishing them.

Fig. 1

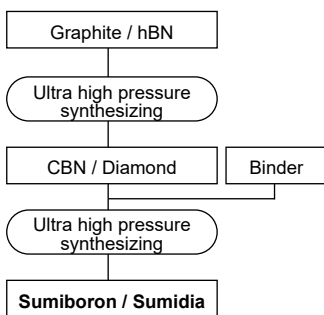
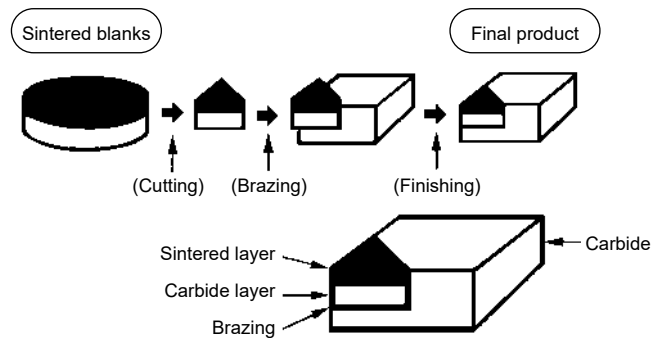
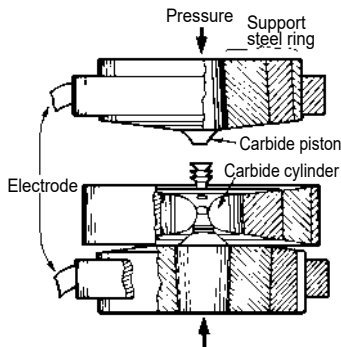

Fig. 2



## SumiBoron / SumiDia Grinding Method

Items		SumiBoron	SumiDia
Grinding machine	-	1) Carbide grinding machine is applicable. 2) R Pointer should be used. 3) Should be wet grinding.	1) Special-purpose high rigidity grinding machine is desirable. 2) Be sure of applying with wet system.
Wheel	Abrasive	Diamond	Diamond
	Grain size	D 25 - medium, D20 - fine (#400-800)	Rough grinding: D 35 (#400 mesh) Finish grinding: D 25 (#800-1500 mesh)
	Bond	Resinoid or vitrified	Special-purpose metal bond for diamond sintered tool or vitrified
	Concentration	100	100-125
	Dressing	Use #400 WA stick	Execute dressing with a WA stick of about 400 mesh.
Grinding condition	Wheel speed	800-1000 m/min.	800-1000 m/min.
	Table cycle	30-60 cycles/min.	30-60 cycles/min.
	Grinding oil	Water soluble grinding coolant oil	Water soluble grinding coolant (Solution type)
Others	-	1) Check chipping of the cutting edge with microscope after finishing. 2) Blank surface cut by EDM should be ground more than 0,05 mm	1) Rake surface is lapped generally 2) Inspect with microscope of magnification of 30-50 times if there is edge chipping. 3) Edge treatment of tool should be sharp for cutting non-ferrous metals. 4) Remove the wire-cut surface of blank by 0,05 mm or more in grinding operation.

# SUMIDIA Series



## General Features

SUMIDIA sintered diamond series has 3 grades (DA1000, DA150, DA90) with individual features depending on the optimum combination of diamond particle size and binder, as well as the NPD10 grade (nano-polycrystalline diamond) where nano-order diamond particles are directly bound with high strength without using binders.

This series is suited to a wide range of applications from machining of aluminium alloy to machining of hard brittle materials and cemented carbide.

## Series • Features • Application

Grade	Features	Application	Average size of Diamond grains (µm)	Hardness Hv	TRS (GPa)
SUMIDIA	<b>DA1000</b>	High density sintered material made of ultra-fine diamond particles that demonstrates optimum wear resistance and excellent edge sharpness.	< 0,5	50 60	≈ 2,60
	<b>DA150</b>	Micro-grained sintered diamond grade with strong diamond-to-diamond bonding. It is suitable for the machining of non-ferrous metals and other very hard materials.	5	50 ~ 60	≈ 1,95
	<b>DA90</b>	Contains coarser diamond particles than other grades, giving it good wear resistance suitable for the machining of carbides and high-silicon aluminium. Shows the highest diamond content for excellent wear resistance.	< 50	50 ~ 60	≈ 1,10
SUMIDIA Binderless	<b>NPD10</b>	A 100% diamond grade made by nano-level diamond grains with direct conversion sintering. Has the highest wear resistance and fracture resistance and the best edge sharpness.	< 0,05	120 ~ 130	≈ 3,15

## Application Range

Machinability	Work Material	Turning		Milling	Example Part	
		Roughing	Finishing			
Good ↑ ↓ Difficult	Sintered aluminium	DA1000			Cylinder liner	
	Die cast aluminium (ADC12)				Transmission case, oil pan, cylinder block, aluminium wheel	
	Low silicon (AC2B-T6, AC4C-T6)				Cylinder head	
	High silicon (T6)				Cylinder block	
					DA150	

## Aluminium

## Non-Aluminium

Machinability	Work Material	Turning		Milling	Example Part
		Roughing	Finishing		
Good ↑ ↓ Difficult	Non-ferrous sintered alloy	DA1000			Bushing
	Gunmetal carbon				Connection rod
	Carbide	DA90	NPD10		Punches, dies, rolls
	Iron combined	DA90	DA150		Cylinder block, bearing cap

## Cutting Performance

Continuous Cutting

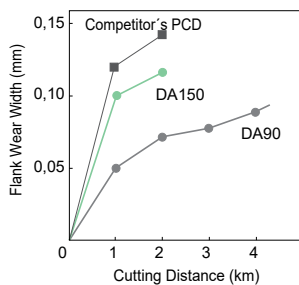

Work Material: MMC (Al-20% SiC)  
Insert: CNMX 120408, Holder: PCLN2525  
Cutting Cond.:  $v_c = 350$  m/min,  $f = 0,2$  mm/rev,  $a_p = 0,18$  mm, wet

Continuous Cutting

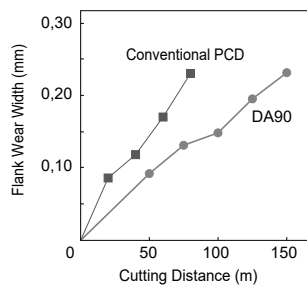

Work Material: Cemented Carbide (87 HRA)  
Insert: DCMW 070204 NF  
Cutting Cond.:  $v_c = 20$  m/min,  $f = 0,1$  mm/rev,  $a_p = 0,2$  mm, wet

Continuous Cutting

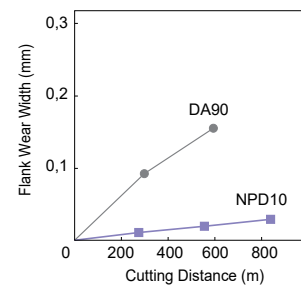

Work Material: Cemented Carbide (91 HRA)  
Insert: DCMW 11T304 RH (NPD10), DCMW 11T304 NF (DA90)  
Cutting Cond.:  $v_c = 20$  m/min,  $f = 0,05$  mm/rev,  $a_p = 0,05$  mm, dry

## Recommended Cutting Conditions

Cutting Conditions	Work Materials	Aluminium Alloys	Copper Alloy	Reinforced Plastics	Wood or Organic Materials	Carbide	Carbon
		Cutting Speed	$v_c$ (m/min)	~ 3.000	~ 1.000	~ 1.000	~ 4.000
Feed rate	$f$ (mm/rev)	~ 0.2	~ 0.2	~ 0.4	~ 0.4	~ 0.2	~ 1,0
Depth of cut	$a_p$ (mm)	~ 3.0	~ 3.0	~ 2.0	-	~ 0.5	~ 2,0

# SUMIDIA Binderless

## Nano-Polycrystalline Diamond



### General Features

Nano-polycrystalline diamond is a type of polycrystalline diamond, produced by directly binding nano-level diamond grains without using any binders.

This material is unique to our company and as compared to conventional diamond grades containing binders, it exhibits higher strength, excellent wear resistance and fracture resistance.

SUMIDIA Binderless is the series of tools with cutting edges made from this high performance nano-polycrystalline diamond.

### Micro-Structure Comparison

Nano-Polycrystalline Diamond  
SEM Structure

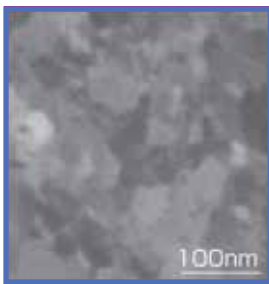

Diamond particle average grain diameter (30 - 50 nm)

Conventional PCD  
SEM Structure

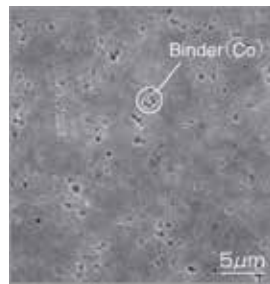

Diamond particle average grain diameter (1 - 10 µm)

### Hardness

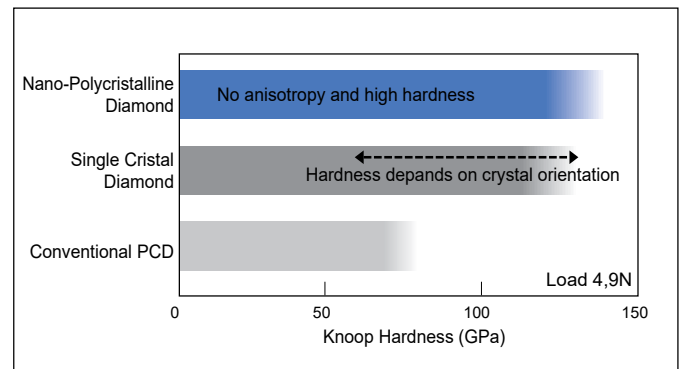

## SUMIDIA Binderless

### Application Examples

- Ballnose Endmill / Radius Endmill (Carbide Machining)

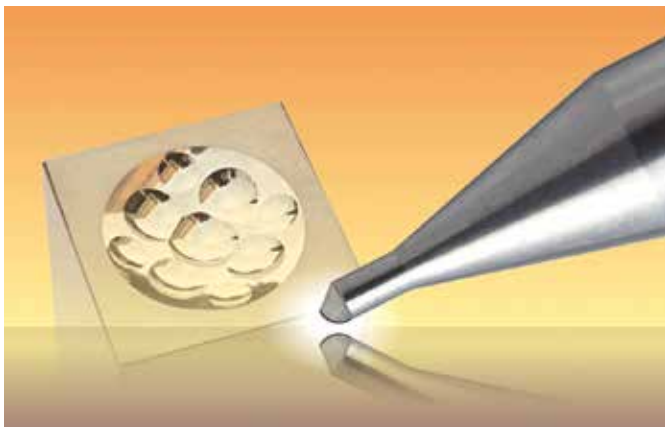

- Indexable Inserts (Carbide Machining)

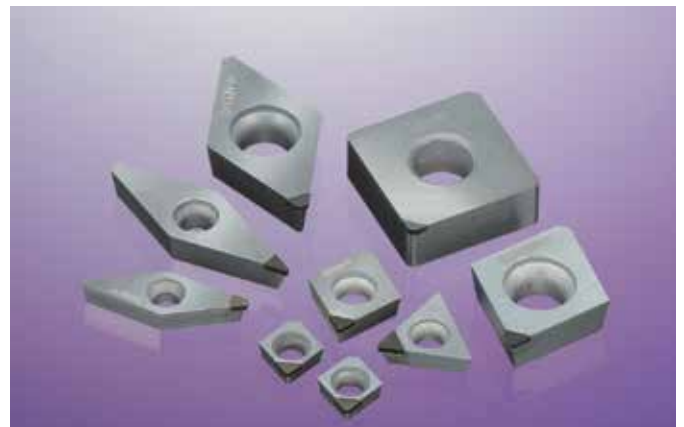

# SUMIDIA Binderless NPD10 / DA90



## General Features

NPD10 is made from high-hardness nano-polycrystalline diamond.

This is a pure diamond material, but unlike single-crystal diamonds, it has no anisotropy.

It achieves extended tool life and machining accuracy superior to conventional diamond tools when machining hard brittle materials such as cemented carbide.

DA90 is a polycrystalline diamond grade in which coarse diamond particles have been sintered to form a dense structure. The high diamond content, with high wear resistance, makes it ideal for roughing of cemented carbide and hard brittle material.

Optimized design and mass production technology have been developed, achieving the same performance as conventional tools with higher cost performance.

## Characteristics

- **Ideal for Finishing of Hard Brittle Materials Including Cemented Carbide (NPD10)**  
High-precision cutting of cemented carbide thanks to the outstanding wear resistance of nano-polycrystalline diamond.
- **Superior Dimensional Tolerance Maintained for a Long Time (NPD10)**  
Tool replacement count can be drastically reduced compared to conventional diamond tools, enabling work efficiency to be improved and total costs to be reduced.
- **Ideal for Roughing of Hard Brittle Materials Including Cemented Carbide (DA90)**  
Stable tool life in sintered surface machining of cemented carbide and roughing of hard brittle materials thanks to the outstanding wear resistance of the coarse-grained polycrystalline diamond.
- **Uses SUMIDIA NF Insert (DA90)**  
Optimized design and mass production technology have been developed, achieving the same performance as conventional tools with higher cost-performance.

## Applicable Range (Cemented Carbide)

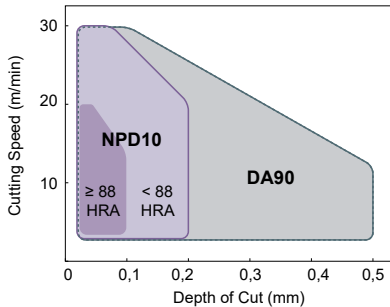

## Applications of NPD10 and DA90 (Cemented Carbide)

Grade	SUMIDIA Binderless NPD10	SUMIDIA DA90
Dimensional Tolerance	⊙ Best	△ The first recommendation is NPD10
Tool Life (Wear Resistance)	⊙ Best $a_p \leq 0,2 \text{ mm}, f \leq 0,1 \text{ mm/rev}$	○ $a_p \geq 0,2 \text{ mm}$ can also be used
Sintered Surface Machining of Cemented Carbide	⊗ Impossible	⊙ Best
Machined Surface Quality	⊙ Best	△ The first recommendation is NPD10

## Recommended Cutting Conditions (Carbide Machining)

Work Material			Grade	Cutting Conditions			
Class	Hardness (HRA)	SEI Grades		Cutting Speed $v_c$ (m/min)	Feed Rate $f$ (mm/rev)	Depth of Cut $a_p$ (mm/rev)	
VM, VC	40	$\geq 88$	G5, D2	NPD10	5-15-20	0,03-0,05-0,07	0,03-0,05-0,07
VM, VC	70, 60, 50	83 - <88	G7, G6	NPD10	5-20-30	0,03-0,10-0,20	0,03-0,10-0,20
VM, VC	-	$\geq 83$	G7, G6, G5, D2	DA90	5-20-30	0,03-0,10-0,20	0,03-0,20-0,50

Min. - Optimum - Max., Cutting conditions: NPD10: dry, DA90: wet

## Machining Precision of NPD10

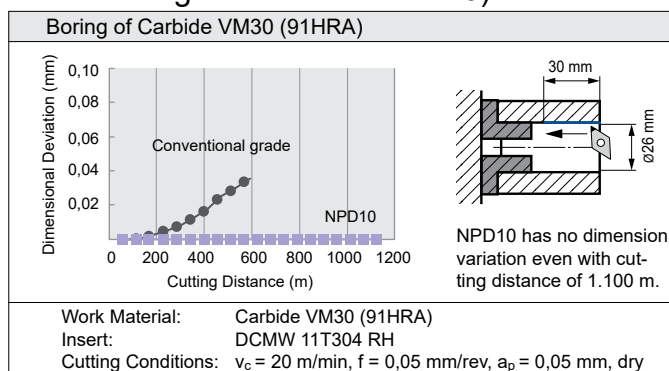

## Wear Resistance of DA90

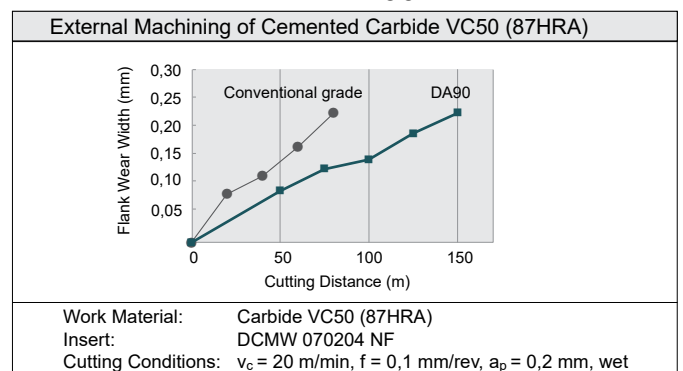

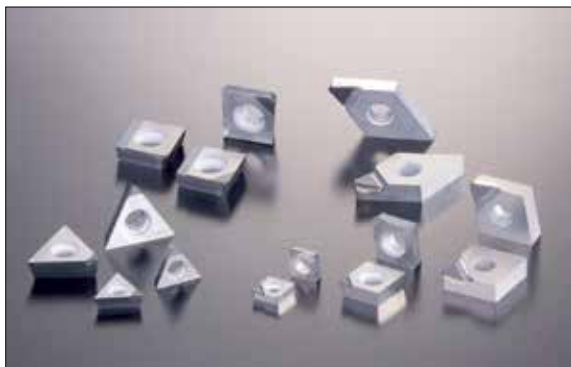

### General Features

SumiDia DA1000 is a high density, ultra fine grained sintered PCD with high toughness similar to that of cemented carbides.

SumiDia DA1000, with its great improvement in fracture resistance, eliminates the breakage problems faced by conventional PCD tools especially during the milling of Aluminium alloys and achieves a longer and more stable tool life.

Furthermore, the NF type inserts makes it even more cost effective.

### Cutting Performance

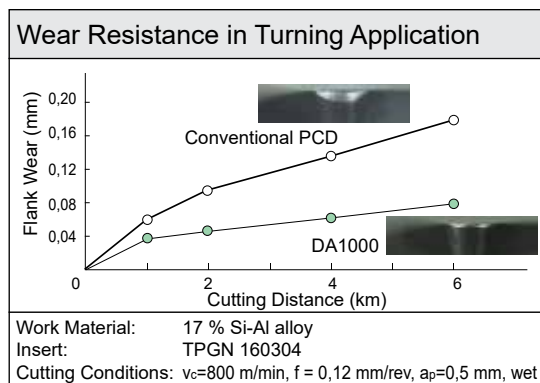
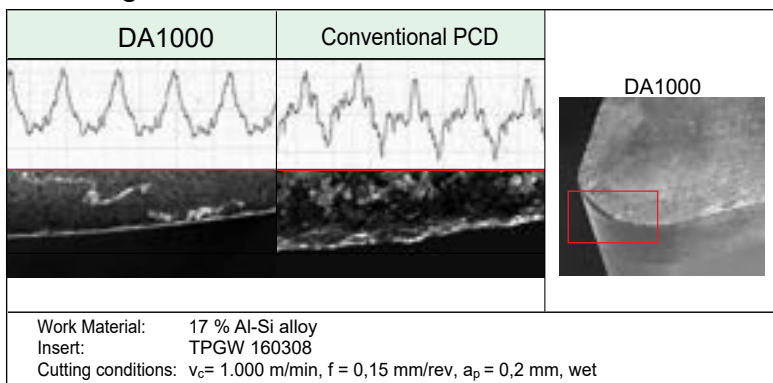

## NF Type Inserts

### General Features

- Total Cost Effectiveness with High Performance and Lower Price
  - Optimum design utilizing improved mass production techniques provides a relatively lower cost.
  - Regrindable type results in huge total cost reduction.
- Wide Application Range
  - Wide range of stocked items for small hole boring, OD turning to milling processes.
  - Negative and positive type inserts that are applicable on standard lever-lock, pin-lock type holders.

### Efficiency

SumiDia NF-type inserts preserve the excellent basic performance of DA1000 while achieving high cost performance through optimal design and development of mass production technology. These inserts achieve the high performance of SUMIDIA DA1000, including excellent fracture resistance, wear resistance and smooth work material surface finishing.

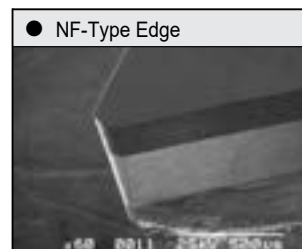

(NF-type is precision ground just like conventional inserts.)

### Application Examples

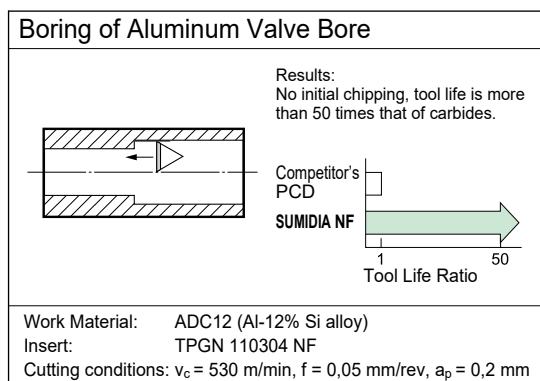
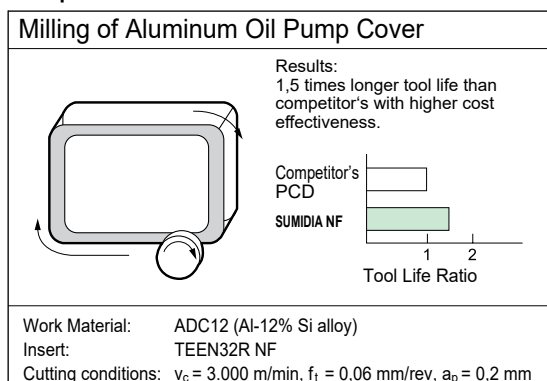





### ■ Characteristics

- Provides excellent chip control in semi finishing and finishing of aluminium alloy.
- Solves chip control problems and dramatically improves work efficiency.
- Achieves stable tool life by employing high toughness grade DA1000.

### ■ Applications Range

Wrought Aluminium Alloy (A6061)

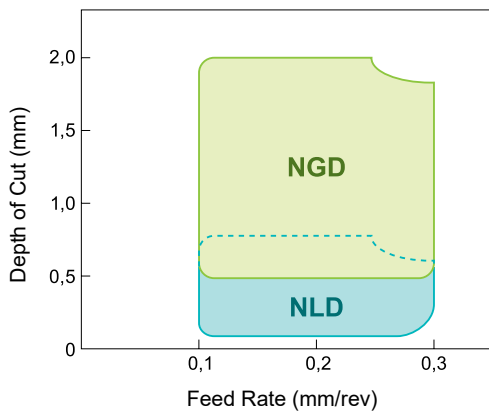

#### NLD Type Chipbreaker

Achieves excellent chip control for finishing.

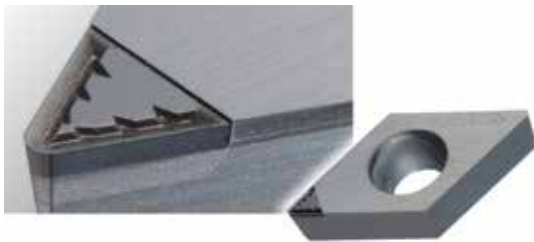

Casted Aluminium Alloy (ADC12)

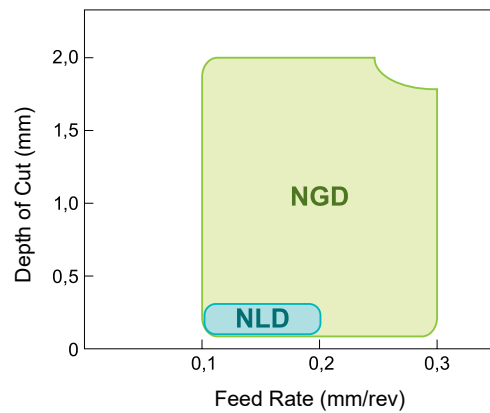

#### NGD Type Chipbreaker

Achieves excellent chip control for semi finishing.



### ■ Application Examples

#### Internal Turning of Machine Component

Provides good chip control in small-depth cutting of wrought Al alloy.

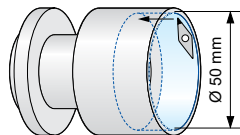

Breakmaster **NLD** type



Without chip breaker

Work Material: A6061  
Insert: VCMT110302 **NLD** NF (DA1000)  
Cutting Conditions:  $v_c = 200$  m/min,  $f = 0,20$  mm/rev,  $a_p = 0,10$  mm, wet

#### Internal Turning of Transmission Component

Offers good chip control in casted material. Small chips - easy to remove.

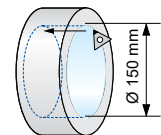

Breakmaster **NGD** type



Without chip breaker

Work Material: ADC12  
Insert: TPMT110304 **NGD** NF (DA1000)  
Cutting Conditions:  $v_c = 400$  m/min,  $f = 0,23$  mm/rev,  $a_p = 1,20$  mm, wet



# SUMIDIA One-Use Inserts Break Master DM Type

**N** Non-ferrous Metal



## General Features

Economy One-Use Insert

- Similar to SumiBoron One-Use type inserts

With Built-in Chipbreaker for Effective Chip Removal

- Solving chip control problems and improving efficiency with DM-type chipbreaker.

Extensive Insert Range for External and Facing Operation

- 80° and 55° diamond shaped inserts are added to expand the application range of this series.

## Application Range

Triangular Type Insert (Boring)

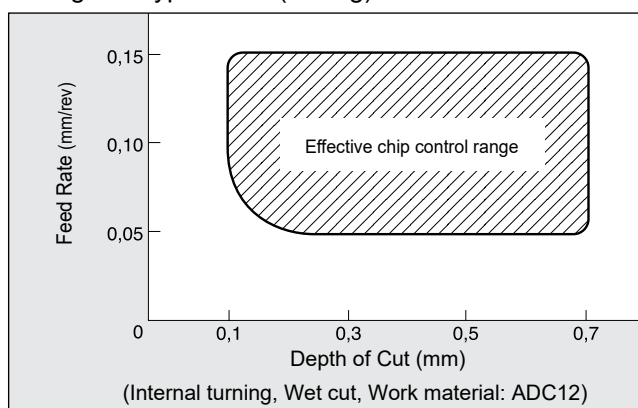

CCMT/DCMT Type (External Turning & Facing)

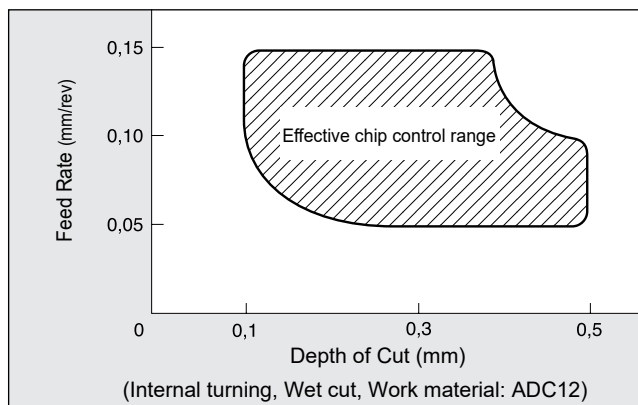

## Chip Control

Break Master



No Chipbreaker



## Application

Machining Details	Cutting Conditions	Results
Work Material: AC2A-T6	$v_c = 300$ m/min $f = 0,06$ mm/rev $a_p = 0,35$ mm	Surface finish of the bore hole was less than $Ra = 1 \mu\text{m}$ .
Operation: Internal Boring	Wet cut	Chips formed was of a uniform curl of about 2 mm in length. There was almost no chips left inside the bore hole.

## Recommended Conditions

Boring (Triangular Insert)

Feed Rate	Depth of Cut	Type
-0.15 mm/rev.	-0,7 mm	Wet cut

External Copying (55°, 80° Diamond Shaped Inserts)

Feed Rate	Depth of Cut	Type
-0.15 mm/rev.	-0,5 mm	Wet cut

For facing process, D.O.C. should be less than 0,4 mm

## Series

External Turning & Facing		Boring	
	CCMT 0602__ L/R-DM NU		TPMT 0802__ L/R-DM NU
	CCMT 09T3__ L/R-DM NU		TPMT 0902__ L/R-DM NU
	DCMT 0702__ L/R-DM NU		TPMR 1103__ L/R-DM NU <sup>(*)</sup>
	DCMT 11T3__ L/R-DM NU		TPMR 1603__ L/R-DM NU <sup>(*)</sup>

(\*) Stock in Japan  
Delivery on request

# SUMIBORON / SUMIDIA Indexable Inserts & Tools

**M1-M80**

# M



## SUMIBORON / SUMIDIA Insert

C / 80° Diamond

D / 55° Diamond

R / Round

S / Square

T / Triangle

V / 35° Diamond

W / Polygon

Special

SUMIDIA Binderless

## SUMIBORON / SUMIDIA Precision Tools

SUMIBORON

SUMIDIA

High Speed Non-Ferrous Mill Expansion

SUMIBORON "BN Finish Mill"

"Helical Master"

"Mould Finish Master"

SUMIDIA "Mould Finish Master" Binderless

SUMIDIA Drills

Insert Identification .....	M2-3
CC__ 7° pos. Type .....	M4-6,8
CP__ 11° pos. Type .....	M7
CN__ neg. Type .....	M9-13
DC__ 7° pos. Type .....	M14-17
DN__ neg. Type .....	M18-21
RN__ neg. Type .....	M22
SC__ 7° pos. Type .....	M23
SN__ neg. Type .....	M24
TB__ 5° pos. Type .....	M25
TC__ 7° pos. Type .....	M26
TN__ neg. Type .....	M27-30
TP__ 11° pos. Type (Without Hole) .....	M31
TP__ 11° pos. Type (With Hole) .....	M32-35
VB__ 5° pos. Type .....	M36-37
VC__ 7° pos. Type .....	M38-39
VN__ neg. Type .....	M40-42
WN__ neg. Type .....	M43
ZNEX neg.-pos. Type .....	M44
Neg.-pos. Type .....	M45
Guidance .....	M46-47
BSME / SEXC Type Small Hole Boring Bars .....	M48-51
BNBB Type Small Hole Boring Bars .....	M52
BNZ / BNB Type Small Hole Boring Bars .....	M53
GWB / PSC Type Grooving Holder .....	M54-55
BNGG Type Threading Holder .....	M56
DABB Type Small Hole Boring Bars .....	M57
ANX Type Face Mill .....	M58-69
RF Type Face Mill .....	M70
SRF Type Face Mill .....	M71
FMU Type Face Mill .....	M72-73
BNES Type Endmill .....	M74
BNBP Type Micro Ball Nose Endmill .....	M75
NPDRS / NPDB(S) Type .....	M76-77
DAL / DDL / DML Type Drills .....	M78-79

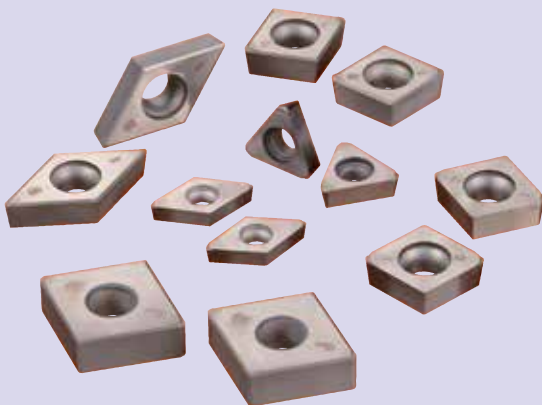

Sumiboron / Sumidia  
Inserts/Tools

# SUMIBORON Insert Identification

## Regrindable Type

# CNMA 120408

# B

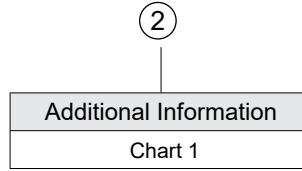
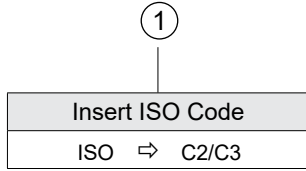

Chart 1

Symbol	Description
B	Full-top CBN insert

## One-Use Type

# CNGG 120408

# N-SV

# NC

# WG

# 4

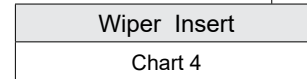
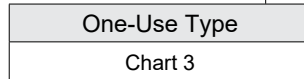
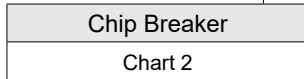
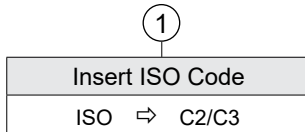

Chart 2

Symbol	Description
–	Standard Type
LF LE	Sharp cutting edge
LT	Small edge treatment type
LS	Low cutting force
ES	High efficiency type
HS	Strong cutting edge
US	Strong cutting edge
N-FV N-LV N-SV	Chipbreaker Type

Chart 3

Symbol	One-Use Type	Grade
NC	Coated SUMIBORON	BNC2115, BNC2125 BNC2010, BNC2020 BNC100, BNC160 BNC200, BNC300 BNC500
		Uncoated CBN
	SUMIBORON binderless	NCB100
NS	Uncoated CBN	BNX25

Chart 4

Symbol	Wiper Insert
WG	Finishing $0,05 \leq f \leq 0,20$
WH	High feed cutting $0,20 \leq f < 0,40$
W	Surface Roughness Standard: $R_z 1,6-3,2\mu\text{m}$

f : Feed Rate (mm/rev)

No. of Cutting Edges

Chart 5
---------

Chart 5

Symbol	No. of Cutting Edges	Type
–	1 cutting edge	Single-corner
2	2 cutting edges	Multi-corner
3	3 cutting edges	
4	4 cutting edges	
6	6 cutting edges	

C

D

R

S

T

V

W

Z

SUMIBORON

Regrindable Type

**CNMA 120408**

**RH**

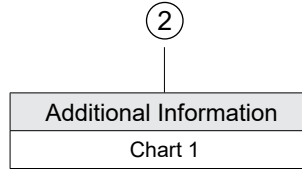
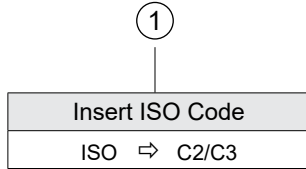

Chart 1

Symbol	Description
RH	Honing specification (treated cutting edge)

One-Use Type

**CNMA 120408**

**N-LD**

**NF**

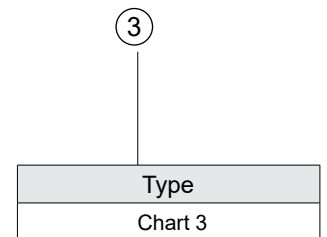
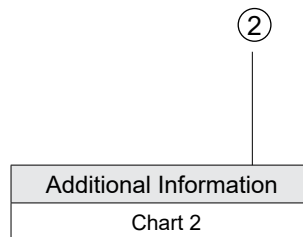
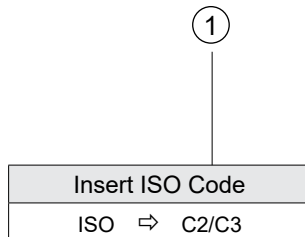

Chart 2

Symbol	Description
N-LD	Chipbreaker type (neutral)
N-GD	
R-DM	Chipbreaker type (right handed)
L-DM	Chipbreaker type (left handed)

Chart 3

Symbol	Description
NF	NF insert ⇨ L26
NU	One use insert

C

D

R

S

T

V

W

Z

# SUMIBORON / SUMIDIA Indexable Inserts

CC-- Type 7° pos. Inserts

80° Diamond Type 7° Relief With Insert Hole







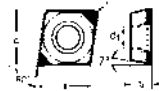

Coated

Dimensions (mm)				
CC--	L	IC	S	D <sub>1</sub>
0602--	6,45	6,35	2,38	2,8
09T3--	9,7	9,525	3,97	4,4

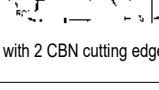
- H** Hardened Steel
- K** Cast Iron
- N** Non-Ferrous Metal
- S** Exotic Alloy
- PM** Sintered Component
- Carbide/Hard Brittle Material

## CCGT / CCGW

### ● G-Class SumiBoron (CBN, One-Use Multi-Corner Type)

Shape	ISO Cat. No.	RE	H Coated											K KH											H Uncoated											K PM KH S											N Uncoated										
			Coated											Uncoated											CBN											PCD											Sumidia										
			BNC2115	BNC2125	BNC2010	BNC2020	BNC100	BNC160	BNC200	BNC300	BNC500	BNC8115	BN1000	BN2000	BNX10	BNX20	BNX25	BNX300	BN350	BN7000	BN7115	BNS8125	NCB100	DA90	DA150	DA1000	NPD10																														
<b>Break Master - FV, LV</b>  CBN with chipbreaker  with 2 CBN cutting edges	CCGT 060204 N-FV NC2	0,4	○	○	●	●	●	●	○																																																
	CCGT 09T304 N-FV NC2	0,4	●	●	●	●	●	●	●																																																
	CCGT 09T308 N-FV NC2	0,8	●	●	●	●	●	●	●																																																
	CCGT 09T304 N-LV NC2	0,4	●	●	●	●	○	●	●																																																
	CCGT 09T308 N-LV NC2	0,8	●	●	●	●	●	●	●																																																
 Standard - Normal cut geometry  with 2 CBN cutting edges  (Wiper Type)	CCGW 060202 NC2	0,2	●	●	●	●	●	●	●	○																																															
	CCGW 060204 NC2	0,4	●	●	●	●	●	●	●	●	○																																														
	CCGW 060208 NC2	0,8	●	●	●	●	●	●	●	●	○																																														
	CCGW 09T302 NC2	0,2	●	○	○	○	○	○	○	○	○																																														
	CCGW 09T304 NC2	0,4	●	●	●	●	●	●	●	●	●																																														
	CCGW 09T308 NC2	0,8	●	●	●	●	●	●	●	●	●																																														
Standard - Normal cut geometry  (Wiper Type)	CCGW 09T304 NC-W2	0,4		●			●	●	●																																																
	CCGW 09T308 NC-W2	0,8		●			●	●	●																																																
	CCGW 09T304 NC-WG2	0,4	●	●	●	●	●	●	●																																																
	CCGW 09T308 NC-WG2	0,8	●	●	●	●	●	●	●																																																
LE - Type Low cutting force  with 2 CBN cutting edges	CCGW 060202 LE-NC2	0,2			●																																																				
	CCGW 060204 LE-NC2	0,4			●																																																				
	CCGW 09T302 LE-NC2	0,2			●																																																				
	CCGW 09T304 LE-NC2	0,4			●																																																				
	CCGW 09T308 LE-NC2	0,8			●																																																				
LT - Type Sharp cutting edge  with 2 CBN cutting edges	CCGW 060202 LT-NC2	0,2				●																																																			
	CCGW 060204 LT-NC2	0,4				●																																																			
	CCGW 09T302 LT-NC2	0,2				○																																																			
	CCGW 09T304 LT-NC2	0,4				●																																																			
	CCGW 09T308 LT-NC2	0,8				●																																																			
LS - Type Low cutting force  with 2 CBN cutting edges	CCGW 060202 LS-NC2	0,2	●	●			●	●																																																	
	CCGW 060204 LS-NC2	0,4	●	●			●	●																																																	
	CCGW 060208 LS-NC2	0,8	○	○			●	●																																																	
	CCGW 09T302 LS-NC2	0,2	○	○			○																																																		
	CCGW 09T304 LS-NC2	0,4	●	●			●	●	●																																																
	CCGW 09T308 LS-NC2	0,8	○	●			●	●	●																																																
HS - Type Strong cutting edge  with 2 CBN cutting edges	CCGW 060208 HS-NC2	0,8								●																																															
	CCGW 09T304 HS-NC2	0,4		●			●	●																																																	
	CCGW 09T308 HS-NC2	0,8		●			●	●																																																	

● = Euro stock  
○ = Stock item in Japan

 Edge Specification of SUMIBORON Inserts

80° Diamond Type 7° Relief  
With Insert Hole



Uncoated

## CCEW / CCGW

Dimensions (mm)				
CC_	L	IC	S	D <sub>1</sub>
0602-	6,45	6,35	2,38	2,8
09T3-	9,7	9,525	3,97	4,4
03X1-		3,5	1,4	1,9
04X1-		4,3	1,8	2,3
1204-	12,9	12,7	4,76	5,5

- H Hardened Steel
- K Cast Iron
- N Non-Ferrous Metal
- S Exotic Alloy
- PM Sintered Component
- Carbide/Hard Brittle Material



● SumiBoron (CBN, One-Use Type)

Shape	ISO Cat. No.	RE	Material Compatibility																									
			BNC2115	BNC2125	BNC2010	BNC2020	BNC100	BNC160	BNC200	BNC300	BNC500	BNC8115	BN1000	BN2000	BNX10	BNX20	BNX25	BN300	BN350	BN7000	BN7115	BNS8125	NCB100	DA90	DA150	DA1000	NPD10	
 LF - Type Low cutting force	CCEW 03X102 LF-NU	0,2																										
	CCEW 03X102 LT-NU CCEW 03X104 LT-NU	0,2 0,4																										
 LT - Type Sharp cutting edge	CCEW 04X102 LT-NU CCEW 04X104 LT-NU	0,2 0,4																										

● G-Class SumiBoron (CBN, Regrindable Type)

 CCGW 09T304 CCGW 09T308	0,4																											
	0,8																											

● G-Class SumiBoron (CBN, One-Use Type)

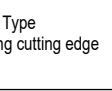
 CCGW 060204 NS CCGW 09T304 NS CCGW 09T308 NS	0,4																											
	0,4																											
	0,8																											
	0,2																											
	0,4																											
	0,8																											
 CCGW 060202 NU CCGW 060204 NU CCGW 060208 NU CCGW 09T302 NU CCGW 09T304 NU CCGW 09T308 NU CCGW 120408 NU	0,2																											
	0,4																											
	0,8																											
	0,2																											
	0,4																											
	0,8																											
 CCGW 060202 LT-NU CCGW 060204 LT-NU CCGW 060208 LT-NU CCGW 09T302 LT-NU CCGW 09T304 LT-NU CCGW 09T308 LT-NU	0,2																											
	0,4																											
	0,8																											
	0,2																											
	0,4																											
	0,8																											
 CCGW 060202 HS-NU CCGW 060204 HS-NU CCGW 09T302 HS-NU CCGW 09T304 HS-NU CCGW 09T308 HS-NU	0,2																											
	0,4																											
	0,2																											
	0,4																											
	0,4																											
	0,8																											

● = Euro stock  
○ = Stock item in Japan

▲ = To be replaced by new item

 L8, L9 Edge Specification of SUMIBORON Inserts

C  
D  
R  
S  
T  
V  
W  
Z

SumiBoron / Sumidia  
Inserts



# SUMIBORON / SUMIDIA Indexable Inserts

CC-- Type 7° pos. Inserts

80° Diamond Type 7° Relief  
With Insert Hole





Uncoated

Dimensions (mm)				
CC--	L	IC	S	D <sub>1</sub>
0602--	6,45	6,35	2,38	2,8
09T3--	9,7	9,525	3,97	4,4

**H** Hardened Steel  
**K** Cast Iron  
**N** Non-Ferrous Metal  
**S** Exotic Alloy  
**PM** Sintered Component  
**■** Carbide/Hard Brittle Material

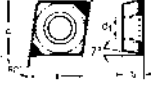
## CCGT / CCGW

● G-Class SumiBoron (CBN, One-Use Multi-Corner Type)

Shape	ISO Cat. No.	RE	Material																									
			Coated						Uncoated						Uncoated													
			CBN																									
			BNC2115	BNC2125	BNC2010	BNC2020	BNC100	BNC160	BNC200	BNC300	BNC500	BNC8115	BN1000	BN2000	BNX10	BNX20	BNX25	BN300	BN350	BN7000	BN7115	BNS8125	NCB100	DA90	DA150	DA1000	NPD10	
 CBN with chipbreaker with 2 CBN cutting edges	CCGT 060204 N-FV NU2	0,4											●															
	CCGT 09T304 N-FV NU2	0,4											●															
	CCGT 09T308 N-FV NU2	0,8											●															
	CCGT 09T304 N-LV NU2	0,4										●																
 with 2 CBN cutting edges	CCGW 060204 NU2	0,4																			○	●						
	CCGW 09T304 NU2	0,4										●	▲									○	●					
	CCGW 09T308 NU2	0,8										●	▲									○	●					
 (Wiper Type)	CCGW 09T304 NU-WG2	0,4										●																
	CCGW 09T308 NU-WG2	0,8										●																
 (Wiper Type)	CCGW 09T304 NU-WH2	0,4										●																
	CCGW 09T308 NU-WH2	0,8										●																
 HS - Type Strong cutting edge with 2 CBN cutting edges	CCGW 09T308 HS-NU2	0,8																			●							

● = Euro stock  
 ○ = Stock item in Japan

▲ = To be replaced by new item

 L8, L9 Edge Specification of SUMIBORON Inserts

C  
 D  
 R  
 S  
 T  
 V  
 W  
 Z  
 SumiBoron / SumiDia  
 Inserts

80° Diamond Type    11° Relief  
With Insert Hole

Coated

Dimensions (mm)				
CP--	L	IC	S	D <sub>1</sub>
0602--	6,45	6,35	2,38	2,8
0802--		7,94	2,38	3,4
0903--		9,525	3,18	4,4

- H** Hardened Steel
- K** Cast Iron
- N** Non-Ferrous Metal
- S** Exotic Alloy
- PM** Sintered Component
- Carbide/Hard Brittle Material

## CPGW ○○○○○○

● G-Class SumiBoron (CBN, One-Use Multi-Corner Type)

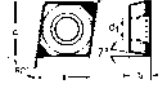
Shape	ISO Cat. No.	RE	Material																								
			Coated					Uncoated																			
			CBN																								
			BNC2115	BNC2125	BNC2010	BNC2020	BNC100	BNC160	BNC200	BNC300	BNC500	BNC8115	BN1000	BN2000	BNX10	BNX20	BNX25	BN300	BN350	BN7000	BN7115	BN8125	NCB100	DA90	DA150	DA1000	NPD10
	CPGW 080202 NC2 CPGW 080204 NC2	0,2			○	○																					
		0,4			○	○																					
	CPGW 090302 NC2 CPGW 090304 NC2	0,2			○	○																					
		0,4			○	○																					

with 2 CBN cutting edges

Uncoated

## CPMW ○○○○○○

● M-Class SumiDia (PCD, NF Type)

Shape	ISO Cat. No.	RE	Material																									
			Coated					Uncoated																				
			CBN																									
			BNC2115	BNC2125	BNC2010	BNC2020	BNC100	BNC160	BNC200	BNC300	BNC500	BNC8115	BN1000	BN2000	BNX10	BNX20	BNX25	BN300	BN350	BN7000	BN7115	BN8125	NCB100	DA90	DA150	DA1000	NPD10	
	CPMW 060208 NF	0,8																										●

● = Euro stock  
○ = Stock item in Japan

 L8, L9 Edge Specification of SUMIBORON Inserts

- C
- D
- R
- S
- T
- V
- W
- Z

SumiBoron / SumiDia  
Inserts

# SUMIBORON / SUMIDIA Indexable Inserts

CC-- Type 7° pos. Inserts

80° Diamond Type 7° Relief With Insert Hole

Uncoated

Dimensions (mm)				
CC--	L	IC	S	D <sub>1</sub>
0602--	6,45	6,35	2,38	2,8
09T3--	9,7	9,525	3,97	4,4
03X1--		3,5	1,4	1,9
04X1--		4,3	1,8	2,3



- H** Hardened Steel
- K** Cast Iron
- N** Non-Ferrous Metal
- S** Exotic Alloy
- PM** Sintered Component
- Carbide/Hard Brittle Material

## CCMT / CCMW

### ● M-Class SumiDia (PCD, Regrindable Type)

Shape	ISO Cat. No.	RE	Material																									
			BNC2115	BNC2125	BNC2010	BNC2020	BNC100	BNC160	BNC200	BNC300	BNC500	BNC8115	BN1000	BN2000	BNX10	BNX20	BNX25	BN300	BN350	BN7000	BN7115	BNS8125	NCB100	DA90	DA150	DA1000	NPD10	
	CCMT 060202	0,2																										
	CCMT 060204	0,4																										
	CCMT 09T302	0,2																										
	CCMT 09T304	0,4																										

### ● M-Class SumiDia (PCD, NF Type)

Shape	ISO Cat. No.	RE	Material																									
			BNC2115	BNC2125	BNC2010	BNC2020	BNC100	BNC160	BNC200	BNC300	BNC500	BNC8115	BN1000	BN2000	BNX10	BNX20	BNX25	BN300	BN350	BN7000	BN7115	BNS8125	NCB100	DA90	DA150	DA1000	NPD10	
	CCMT 060201 NF	0,1																										
	CCMT 060202 NF	0,2																										
	CCMT 060204 NF	0,4																										
	CCMT 09T301 NF	0,1																										
	CCMT 09T302 NF	0,2																										
	CCMT 09T304 NF	0,4																										
	CCMT 09T308 NF	0,8																										

### ● M-Class SumiDia (PCD, One-Use "Break Master" Type)

Break Master Type	ISO Cat. No.	RE	Material																									
			BNC2115	BNC2125	BNC2010	BNC2020	BNC100	BNC160	BNC200	BNC300	BNC500	BNC8115	BN1000	BN2000	BNX10	BNX20	BNX25	BN300	BN350	BN7000	BN7115	BNS8125	NCB100	DA90	DA150	DA1000	NPD10	
Break Master - DM	CCMT 060204 L-DM NU	0,4																										
	CCMT 09T302 L-DM NU	0,2																										
	CCMT 09T304 L-DM NU	0,4																										
Break Master - LD	CCMT 060202 N-LD NF	0,2																										
	CCMT 060204 N-LD NF	0,4																										
	CCMT 09T302 N-LD NF	0,2																										
Break Master - GD	CCMT 060202 N-GD NF	0,2																										
	CCMT 060204 N-GD NF	0,4																										
	CCMT 09T302 N-GD NF	0,2																										

### ● M-Class SumiDia (PCD, NF Type)

Shape	ISO Cat. No.	RE	Material																									
			BNC2115	BNC2125	BNC2010	BNC2020	BNC100	BNC160	BNC200	BNC300	BNC500	BNC8115	BN1000	BN2000	BNX10	BNX20	BNX25	BN300	BN350	BN7000	BN7115	BNS8125	NCB100	DA90	DA150	DA1000	NPD10	
	CCMW 03X102 NF	0,2																										
	CCMW 03X104 NF	0,4																										
	CCMW 04X102 NF	0,2																										
	CCMW 04X104 NF	0,4																										
	CCMW 060202 NF	0,2																										
	CCMW 060204 NF	0,4																										
	CCMW 09T302 NF	0,2																										
	CCMW 09T304 NF	0,4																										

### ● M-Class SumiDia (PCD, Binderless)

Shape	ISO Cat. No.	RE	Material																									
			BNC2115	BNC2125	BNC2010	BNC2020	BNC100	BNC160	BNC200	BNC300	BNC500	BNC8115	BN1000	BN2000	BNX10	BNX20	BNX25	BN300	BN350	BN7000	BN7115	BNS8125	NCB100	DA90	DA150	DA1000	NPD10	
	CCMW 03X102 RH	0,2																										
	CCMW 03X104 RH	0,4																										
	CCMW 04X102 RH	0,2																										
	CCMW 04X104 RH	0,4																										
	CCMW 060202 RH	0,2																										
	CCMW 060204 RH	0,4																										
	CCMW 09T302 RH	0,2																										
	CCMW 09T304 RH	0,4																										

● = Euro stock  
○ = Stock item in Japan

 L8, L9 Edge Specification of SUMIBORON Inserts

C  
D  
R  
S  
T  
V  
W  
Z  
Sumiboron / SumiDia Inserts

80° Diamond Type      0° Relief  
With Insert Hole







Coated

Dimensions (mm)				
CN--	L	IC	S	D <sub>1</sub>
1204--	12,9	12,7	4,76	5,16

- H** Hardened Steel
- K** Cast Iron
- N** Non-Ferrous Metal
- S** Exotic Alloy
- PM** Sintered Component
- Carbide/Hard Brittle Material

## CNGA

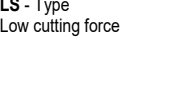
● G-Class SumiBoron (CBN, One-Use Multi-Corner Type)

Shape	ISO Cat. No.	RE	Material																									
			Coated					Uncoated																				
			BNC2115	BNC2125	BNC2010	BNC2020	BNC100	BNC160	BNC200	BNC300	BNC500	BNC8115	BN1000	BN2000	BNX10	BNX20	BNX25	BN300	BN350	BN7000	BN7115	BNS8125	NCB100	DA90	DA150	DA1000	NPD10	
<b>Standard - Normal cut geometry</b>  with 2 CBN cutting edges  with 4 CBN cutting edges  (Wiper Type)  (Wiper Type)	CNGA 120404 NC2 CNGA 120408 NC2 CNGA 120412 NC2 CNGA 120416 NC2 CNGA 120420 NC2 CNGA 120424 NC2	0,4 0,8 1,2 1,6 2,0 2,4	●	○	○	○																						
	CNGA 120402 NC4 CNGA 120404 NC4 CNGA 120408 NC4 CNGA 120412 NC4 CNGA 120416 NC4 CNGA 120420 NC4 CNGA 120424 NC4	0,2 0,4 0,8 1,2 1,6 2,0 2,4	○	○	○	○	○	○	○	○	○	○	○	○	○	○	○	○	○	○	○	○	○	○	○	○	○	○
	CNGA 120404 NC-W4 CNGA 120408 NC-W4	0,4 0,8	●	●			●	●	●																			
	CNGA 120404 NC-WG4 CNGA 120408 NC-WG4 CNGA 120412 NC-WG4	0,4 0,8 1,2	●	●	●	●		●	●																			
	CNGA 120404 NC-WH4 CNGA 120408 NC-WH4 CNGA 120412 NC-WH4	0,4 0,8 1,2	●	●	●	●		●	●																			
	<b>LE - Type</b> Low cutting force  with 2 CBN cutting edges	CNGA 120404 LE-NC2 CNGA 120408 LE-NC2 CNGA 120412 LE-NC2	0,4 0,8 1,2		●																							
		<b>LT - Type</b> Sharp cutting edge  with 2 CBN cutting edges	CNGA 120402 LT-NC2 CNGA 120404 LT-NC2 CNGA 120408 LT-NC2 CNGA 120412 LT-NC2	0,2 0,4 0,8 1,2			○																					
			<b>LS - Type</b> Low cutting force  with 2 CBN cutting edges	CNGA 120402 LS-NC2 CNGA 120404 LS-NC2 CNGA 120408 LS-NC2 CNGA 120412 LS-NC2	0,2 0,4 0,8 1,2		○																					
	<b>LS - Type</b> Low cutting force  with 4 CBN cutting edges			CNGA 120404 LS-NC4 CNGA 120408 LS-NC4 CNGA 120412 LS-NC4	0,4 0,8 1,2						○																	
		<b>ES - Type</b> Crater wear stability  with 4 CBN cutting edges		CNGA 120404 ES-NC4 CNGA 120408 ES-NC4 CNGA 120412 ES-NC4	0,4 0,8 1,2			●																				

● = Euro stock  
○ = Stock item in Japan

 Edge Specification of SUMIBORON Inserts

- C**
- D**
- R**
- S**
- T**
- V**
- W**
- Z**

SumiBoron / Sumidia Inserts

# SUMIBORON / SUMIDIA Indexable Inserts

CN- Type neg. Inserts

80° Diamond Type 0° Relief  
With Insert Hole



Coated

Dimensions (mm)				
CN--	L	IC	S	D <sub>1</sub>
1204--	12,9	12,7	4,76	5,16

- H** Hardened Steel
- K** Cast Iron
- N** Non-Ferrous Metal
- S** Exotic Alloy
- PM** Sintered Component
- Carbide/Hard Brittle Material

## CNGA / CNGG

● G-Class SumiBoron (CBN, One-Use Multi-Corner Type)

Shape	ISO Cat. No.	RE	H		K		N		S		PM		■															
			Coated		Uncoated		Uncoated		Uncoated		Uncoated		Uncoated															
			CBN												Uncoated	Uncoated												
			BNC2115	BNC2125	BNC2010	BNC2020	BNC100	BNC160	BNC200	BNC300	BNC500	BNC8115	BN1000	BN2000	BNX10	BNX20	BNX25	BN300	BN350	BN7000	BN7115	BNS8125	NCB100	DA90	DA150	DA1000	NPD10	
 HS - Type Strong cutting edge with 2 CBN cutting edges	CNGA 120404 HS-NC2 CNGA 120408 HS-NC2 CNGA 120412 HS-NC2	0,4 0,8 1,2	●	●	●	●	●	●	●	●	●																	
	CNGA 120404 HS-NC4 CNGA 120408 HS-NC4 CNGA 120412 HS-NC4	0,4 0,8 1,2	○	○	○	○	○	○	○	○	○	○																
 Break Master - FV, LV, SV CBN with chipbreaker with 4 CBN cutting edges	CNGG 120404 N-FV NC4 CNGG 120408 N-FV NC4 CNGG 120412 N-FV NC4	0,4 0,8 1,2	●	●	●	●	●	●	●	●	●																	
	CNGG 120404 N-LV NC4 CNGG 120408 N-LV NC4 CNGG 120412 N-LV NC4	0,4 0,8 1,2	●	●	●	●	●	●	●	●	●	●																
	CNGG 120408 N-SV NC4 CNGG 120412 N-SV NC4	0,8 1,2	●	●	●	●	○	●	●	●	●																	

● = Euro stock  
○ = Stock item in Japan

L8, L9

Edge Specification of SUMIBORON Inserts

80° Diamond Type 0° Relief  
With Insert Hole

Uncoated

Dimensions (mm)				
CN--	L	IC	S	D <sub>1</sub>
1204--	12,9	12,7	4,76	5,16

- H** Hardened Steel
- K** Cast Iron
- N** Non-Ferrous Metal
- S** Exotic Alloy
- PM** Sintered Component
- Carbide/Hard Brittle Material

## CNGA

● G-Class SumiBoron (CBN, One-Use Multi-Corner Type)

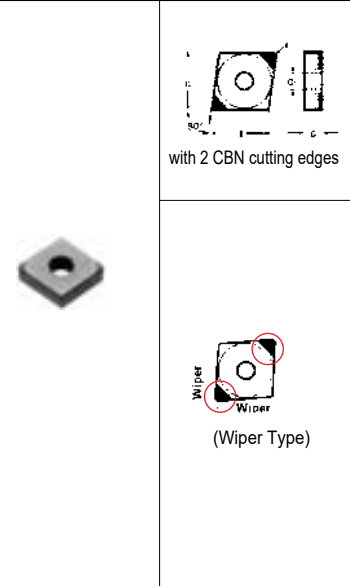
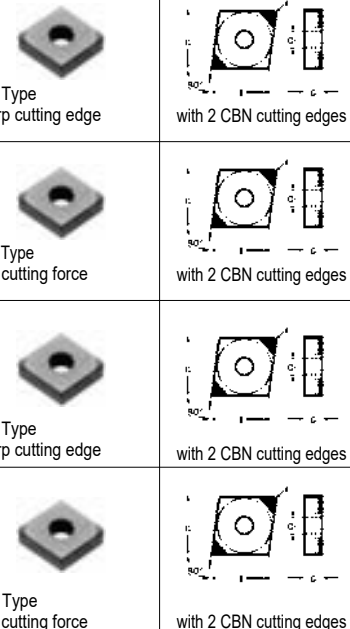
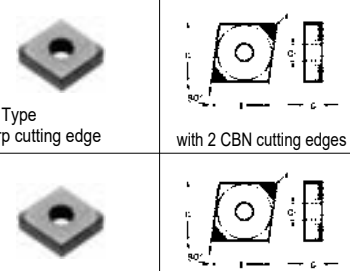
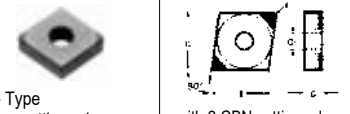
Shape	ISO Cat. No.	RE	Material																									
			Coated			Uncoated																						
			CBN																									
			BNC2115	BNC2125	BNC2010	BNC2020	BNC100	BNC160	BNC200	BNC300	BNC500	BNC8115	BN1000	BN2000	BNX10	BNX20	BNX25	BN300	BN350	BN7000	BN7115	BNS8125	NCB100	DA90	DA150	DA1000	NPD10	
 <p>with 2 CBN cutting edges</p> <p>(Wiper Type)</p>	CNGA 120404 NS2 CNGA 120408 NS2 CNGA 120412 NS2	0,4 0,8 1,2																										
	CNGA 120404 NU2 CNGA 120408 NU2 CNGA 120412 NU2	0,4 0,8 1,2											○	●	●	●	●	●	●	○	○							
	CNGA 120404 NU-W2 CNGA 120408 NU-W2	0,4 0,8											●	●														
	CNGA 120404 NU-WG2 CNGA 120408 NU-WG2 CNGA 120412 NU-WG2	0,4 0,8 1,2												○	●	●	●	●	●	○	○							
 <p>with 2 CBN cutting edges</p>	CNGA 120404 LF-NU2 CNGA 120408 LF-NU2	0,4 0,8																		○	○							
	CNGA 120404 LE-NU2 CNGA 120408 LE-NU2	0,4 0,8																			○	○						
 <p>with 2 CBN cutting edges</p>	CNGA 120404 LT-NU2 CNGA 120408 LT-NU2 CNGA 120412 LT-NU2	0,4 0,8 1,2											○	○														
	CNGA 120404 LS-NU2	0,4																			○							
 <p>with 2 CBN cutting edges</p>	CNGA 120408 HT-NU2 CNGA 120412 HT-NU2	0,8 1,2																		○	○							

● = Euro stock  
○ = Stock item in Japan

▲ = To be replaced by new item

 L8, L9 Edge Specification of SUMIBORON Inserts

- 
- 
- 
- 
- 
- 
- 
- 

SumiBoron / Sumidia Inserts



# SUMIBORON / SUMIDIA Indexable Inserts

CN- Type neg. Inserts

80° Diamond Type 0° Relief  
With Insert Hole







Uncoated

Dimensions (mm)				
CN--	L	IC	S	D <sub>1</sub>
1204--	12,9	12,7	4,76	5,16

- H** Hardened Steel
- K** Cast Iron
- N** Non-Ferrous Metal
- S** Exotic Alloy
- PM** Sintered Component
- Carbide/Hard Brittle Material

## CNGA / CNGM

### ● G-Class SumiBoron (CBN, One-Use Multi-Corner Type)

Shape	ISO Cat. No.	RE	CBN													Uncoated	PCD	Sumidia										
			Coated			Uncoated																						
			BNC2115	BNC2125	BNC2010	BNC2020	BNC100	BNC160	BNC200	BNC300	BNC500	BNC8115	BN1000	BN2000	BNX10	BNX20	BNX25	BN300	BN350	BN7000	BN7115	BNS8125	NCB100	DA90	DA150	DA1000	NPD10	
 HS - Type Strong cutting edge  with 2 CBN cutting edges	<b>CNGA 120404 HS-NU2</b> <b>CNGA 120408 HS-NU2</b> <b>CNGA 120412 HS-NU2</b>	0,4											○															
		0,8												○														
		1,2													○													
 US - Type Strong cutting edge  with 2 CBN cutting edges	<b>CNGA 120404 US-NU2</b>	0,4																			○							
<b>Break Master - LV</b>  CBN with chipbreaker  with 2 CBN cutting edges	<b>CNGM 120404 N-LV NU2</b> <b>CNGM 120412 N-LV NU2</b>	0,4											●															
		1,2											●															

### ● G-Class SumiBoron (CBN, Binderless)

	<b>CNGA 120404 NU</b> <b>CNGA 120408 NU</b> <b>CNGA 120412 NU</b>	0,4																										
		0,8																										
		1,2																										

● = Euro stock  
○ = Stock item in Japan

 L8, L9 Edge Specification of SUMIBORON Inserts

- C
- D
- R
- S
- T
- V
- W
- Z

SumiBoron / SumiDia  
Inserts

80° Diamond Type	0° Relief
	—

Coated / Uncoated

Dimensions (mm)				
CN-	L	IC	S	D <sub>1</sub>
0903--	9,7	9,525	3,18	4,4
1204--	12,9	12,7	4,76	5,16

- H** Hardened Steel
- K** Cast Iron
- N** Non-Ferrous Metal
- S** Exotic Alloy
- PM** Sintered Component
- Carbide/Hard Brittle Material

## CNGN / CNGX

### ● G-Class SumiBoron (Solid CBN Type)

Shape	ISO Cat. No.	RE	Dimensions (mm)																								
			BNC2115	BNC2125	BNC2010	BNC2020	BNC100	BNC160	BNC200	BNC300	BNC500	BNC8115	BN1000	BN2000	BNX10	BNX20	BNX25	BN300	BN350	BN7000	BN7115	BNS8125	NCB100	DA90	DA150	DA1000	NPD10
	CNGN 090308	0,8									●											●					
	CNGN 090312	1,2									●											●					
	CNGN 120408	0,8									●											●					
	CNGN 120412	1,2									●											●					
	CNGN 120416	1,6									●											●					

### ● G-Class SumiBoron (Solid CBN, "Dimple" Type)



Shape	ISO Cat. No.	RE	Dimensions (mm)																								
			BNC2115	BNC2125	BNC2010	BNC2020	BNC100	BNC160	BNC200	BNC300	BNC500	BNC8115	BN1000	BN2000	BNX10	BNX20	BNX25	BN300	BN350	BN7000	BN7115	BNS8125	NCB100	DA90	DA150	DA1000	NPD10
	CNGX 120412	1,2									●											●					
	CNGX 120416	1,6									●											●					

## CNMA / CNMX

### ● M-Class SumiBoron (CBN, Regrindable Type)

Shape	ISO Cat. No.	RE	Dimensions (mm)																								
			BNC2115	BNC2125	BNC2010	BNC2020	BNC100	BNC160	BNC200	BNC300	BNC500	BNC8115	BN1000	BN2000	BNX10	BNX20	BNX25	BN300	BN350	BN7000	BN7115	BNS8125	NCB100	DA90	DA150	DA1000	NPD10
	CNMA 120404	0,4													●												
	CNMA 120408	0,8													●												
	CNMA 120412	1,2													●												

### ● M-Class SumiBoron (CBN, One-use Type)

Shape	ISO Cat. No.	RE	Dimensions (mm)																								
			BNC2115	BNC2125	BNC2010	BNC2020	BNC100	BNC160	BNC200	BNC300	BNC500	BNC8115	BN1000	BN2000	BNX10	BNX20	BNX25	BN300	BN350	BN7000	BN7115	BNS8125	NCB100	DA90	DA150	DA1000	NPD10
	CNMA 120404 NS	0,4													●												
	CNMA 120408 NS	0,8													●												
	CNMA 120412 NS	1,2													●												
	CNMA 120404 NU	0,4										●		▲	●		▲		●								
	CNMA 120408 NU	0,8										●		▲	●		▲		●								
	CNMA 120412 NU	1,2										●		▲	●		▲		●								
 (Wiper Type)	CNMA 120408 NU-W	0,8											▲	●													

### ● M-Class SumiDia (PCD, NF Type)

Shape	ISO Cat. No.	RE	Dimensions (mm)																								
			BNC2115	BNC2125	BNC2010	BNC2020	BNC100	BNC160	BNC200	BNC300	BNC500	BNC8115	BN1000	BN2000	BNX10	BNX20	BNX25	BN300	BN350	BN7000	BN7115	BNS8125	NCB100	DA90	DA150	DA1000	NPD10
	CNMX 120402 NF	0,2																									●
	CNMX 120404 NF	0,4																									●
	CNMX 120408 NF	0,8																									●
	CNMX 120412 NF	1,2																									●

● = Euro stock  
○ = Stock item in Japan

▲ = To be replaced by new item

 L8, L9 Edge Specification of SUMIBORON Inserts

- C**
- D**
- R**
- S**
- T**
- V**
- W**
- Z**

SumiBoron / SumiDia Indexable Inserts

# SUMIBORON / SUMIDIA Indexable Inserts

DC-- Type 7° pos. Inserts

55° Diamond Type 7° Relief With Insert Hole

Coated

Dimensions (mm)				
DC--	L	IC	S	D <sub>1</sub>
0702--	7,75	6,35	2,38	2,8
11T3--	11,6	9,525	3,97	4,4

- H** Hardened Steel
- K** Cast Iron
- N** Non-Ferrous Metal
- S** Exotic Alloy
- PM** Sintered Component
- Carbide/Hard Brittle Material

## DCGT / DCGW

● G-Class SumiBoron (CBN, One-Use Multi-Corner Type)

Shape	ISO Cat. No.	RE	Material																								
			Coated								Uncoated								Uncoated								
			CBN																								
			BNC2115	BNC2125	BNC2010	BNC2020	BNC100	BNC160	BNC200	BNC300	BNC500	BN8115	BN1000	BN2000	BNX10	BNX20	BNX25	BN300	BN350	BN7000	BN7115	BNS8125	NCB100	DA90	DA150	DA1000	NPD10
<b>Break Master - FV, LV</b>  CBN with chipbreaker with 2 CBN cutting edges	<b>DCGT 070204 N-FV NC2</b> <b>DCGT 11T304 N-FV NC2</b> <b>DCGT 11T308 N-FV NC2</b>	0,4 0,4 0,8	●	●	●	●	●	●	●	●	●	●	●	●	●	●	●	●	●	●	●	●	●	●	●	●	●
	<b>DCGT 11T304 N-LV NC2</b> <b>DCGT 11T308 N-LV NC2</b>	0,4 0,8	●	●	●	●	●	●	●	●	●	●	●	●	●	●	●	●	●	●	●	●	●	●	●	●	●
Standard - Normal cut geometry (Wiper Type)	<b>DCGW 070202 NC2</b> <b>DCGW 070204 NC2</b> <b>DCGW 070208 NC2</b>	0,2 0,4 0,8	●	●	●	●	●	●	●	●	●	●	●	●	●	●	●	●	●	●	●	●	●	●	●	●	●
	<b>DCGW 11T302 NC2</b> <b>DCGW 11T304 NC2</b> <b>DCGW 11T308 NC2</b>	0,2 0,4 0,8	●	●	●	●	●	●	●	●	●	●	●	●	●	●	●	●	●	●	●	●	●	●	●	●	●
	<b>DCGW 11T304 NC-WG2</b> <b>DCGW 11T308 NC-WG2</b>	0,4 0,8	●	●	●	●	●	●	●	●	●	●	●	●	●	●	●	●	●	●	●	●	●	●	●	●	●
LE - Type Low cutting force	<b>DCGW 11T302 LE-NC2</b> <b>DCGW 11T304 LE-NC2</b> <b>DCGW 11T308 LE-NC2</b>	0,2 0,4 0,8	●	○	●	●	●	●	●	●	●	●	●	●	●	●	●	●	●	●	●	●	●	●	●	●	●
	<b>DCGW 070202 LT-NC2</b> <b>DCGW 070204 LT-NC2</b>	0,2 0,4	●	●	●	●	●	●	●	●	●	●	●	●	●	●	●	●	●	●	●	●	●	●	●	●	●
LT - Type Sharp cutting edge	<b>DCGW 11T302 LT-NC2</b> <b>DCGW 11T304 LT-NC2</b> <b>DCGW 11T308 LT-NC2</b>	0,2 0,4 0,8	●	●	●	●	●	●	●	●	●	●	●	●	●	●	●	●	●	●	●	●	●	●	●	●	●
	<b>DCGW 070202 LS-NC2</b> <b>DCGW 070204 LS-NC2</b> <b>DCGW 070208 LS-NC2</b>	0,2 0,4 0,8	●	●	●	●	●	●	●	●	●	●	●	●	●	●	●	●	●	●	●	●	●	●	●	●	●
	<b>DCGW 11T302 LS-NC2</b> <b>DCGW 11T304 LS-NC2</b> <b>DCGW 11T308 LS-NC2</b>	0,2 0,4 0,8	●	●	●	●	●	●	●	●	●	●	●	●	●	●	●	●	●	●	●	●	●	●	●	●	●
HS - Type Strong cutting edge	<b>DCGW 11T304 HS-NC2</b> <b>DCGW 11T308 HS-NC2</b>	0,4 0,8	●	●	●	●	●	●	●	●	●	●	●	●	●	●	●	●	●	●	●	●	●	●	●	●	●

● = Euro stock  
○ = Stock item in Japan

Edge Specification of SUMIBORON Inserts

55° Diamond Type 7° Relief  
With Insert Hole



Uncoated

Dimensions (mm)				
DC--	L	IC	S	D <sub>1</sub>
0702--	7,75	6,35	2,38	2,8
11T3--	11,6	9,525	3,97	4,4

- H Hardened Steel
- K Cast Iron
- N Non-Ferrous Metal
- S Exotic Alloy
- PM Sintered Component
- Carbide/Hard Brittle Material

## DCGT / DCGW

● G-Class SumiBoron (CBN, One-Use Multi-Corner Type)

Shape	ISO Cat. No.	RE	Material																									
			Coated								Uncoated																	
			BNC2115	BNC2125	BNC2010	BNC2020	BNC100	BNC160	BNC200	BNC300	BNC500	BNC8115	BN1000	BN2000	BNX10	BNX20	BNX25	BN300	BN350	BN7000	BN7115	BNS8125	NCB100	DA90	DA150	DA1000	NPD10	
<b>Break Master - FV, LV</b>  CBN with chipbreaker with 2 CBN cutting edges	DCGT 070204 N-FV NU2	0,4										●																
	DCGT 11T304 N-FV NU2 DCGT 11T308 N-FV NU2	0,4 0,8										○																
	DCGT 11T304 N-LV NU2 DCGT 11T308 N-LV NU2	0,4 0,8										●																
 with 2 CBN cutting edges	DCGW 070202 NU2 DCGW 070204 NU2 DCGW 070208 NU2	0,2 0,4 0,8									●	●	▲	●	▲	●	●	●	○									
	DCGW 11T302 NU2 DCGW 11T304 NU2 DCGW 11T308 NU2	0,2 0,4 0,8									●	●	▲	●	▲	●	●	●	○									
	DCGW 11T304 NU-WG2 DCGW 11T308 NU-WG2	0,4 0,8										●																
 (Wiper Type)	DCGW 11T304 NU-WH2	0,4									●																	
	DCGW 11T302 LF-NU2 DCGW 11T304 LF-NU2 DCGW 11T308 LF-NU2	0,2 0,4 0,8																	○	●								
<b>LF - Type</b> Sharp cutting edge with 2 CBN cutting edges	DCGW 11T302 LE-NU2 DCGW 11T304 LE-NU2 DCGW 11T308 LE-NU2	0,2 0,4 0,8																	○	○	○	○						
	DCGW 11T302 LS-NU2 DCGW 11T304 LS-NU2 DCGW 11T308 LS-NU2	0,2 0,4 0,8																		○	○	○	○					
	DCGW 070208 HS-NU2 DCGW 11T304 HS-NU2 DCGW 11T308 HS-NU2	0,8 0,4 0,8																		●	●	●						

● = Euro stock  
 ○ = Stock item in Japan

▲ = To be replaced by new item

 L8, L9 Edge Specification of SUMIBORON Inserts

- C
- D
- R
- S
- T
- V
- W
- Z

SumiBoron / Sumidia Inserts

# SUMIBORON / SUMIDIA Indexable Inserts

DC-- Type 7° pos. Inserts

55° Diamond Type 7° Relief  
With Insert Hole







Uncoated

Dimensions (mm)				
DC--	L	IC	S	D <sub>1</sub>
0702--	7,75	6,35	2,38	2,8
11T3--	11,6	9,525	3,97	4,4

- H** Hardened Steel
- K** Cast Iron
- N** Non-Ferrous Metal
- S** Exotic Alloy
- PM** Sintered Component
- Carbide/Hard Brittle Material

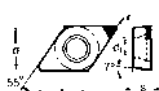
## DCGT / DCGW

● G-Class SumiBoron (CBN, One-Use Type)

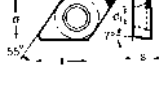
Shape	ISO Cat. No.	RE	Material																										
			Coated								Uncoated																		
			CBN																										
			BNC2115	BNC2125	BNC2010	BNC2020	BNC100	BNC160	BNC200	BNC300	BNC500	BNC8115	BN1000	BN2000	BNX10	BNX20	BNX25	BN300	BN350	BN7000	BN7115	BNS8125	NCB100	DA90	DA150	DA1000	NPD10		
 DCGW 11T304 NS DCGW 11T308 NS		0,4																											
		0,8																	●										
 DCGW 070202 NU DCGW 070204 NU DCGW 070208 NU   DCGW 11T301 NU DCGW 11T302 NU DCGW 11T304 NU DCGW 11T308 NU DCGW 11T312 NU		0,2											●	●	▲	●													
		0,4												●	●	▲	●												
		0,8												●	●	▲	●												
		0,1													●	●	▲	●											
		0,2													●	●	▲	●											
		0,4													●	●	▲	●											
 DCGW 11T302 LF-NU  LF - Type Low cutting force		0,2																											
 DCGW 070202 LT-NU DCGW 070204 LT-NU DCGW 070208 LT-NU  LT - Type Sharp cutting edge		0,2																											
		0,4																											
		0,8																											
		0,2																											
 DCGW 11T302 LT-NU DCGW 11T304 LT-NU DCGW 11T308 LT-NU DCGW 11T312 LT-NU		0,4																											
		0,8																											
		1,2																											
 DCGW 070202 HS-NU DCGW 070204 HS-NU  HS - Type Strong cutting edge		0,2																											
		0,4																											
		0,2																											
 DCGW 11T302 HS-NU DCGW 11T304 HS-NU DCGW 11T308 HS-NU		0,4																											
		0,8																											
		0,8																											

● = Euro stock  
○ = Stock item in Japan

▲ = To be replaced by new item

 L8, L9

C

D

R

S

T

V

W

Z

55° Diamond Type 7° Relief  
With Insert Hole



Uncoated

Dimensions (mm)				
DC--	L	IC	S	D <sub>1</sub>
0702--	7,75	6,35	2,38	2,8
11T3--	11,6	9,525	3,97	4,4



- H Hardened Steel
- K Cast Iron
- N Non-Ferrous Metal
- S Exotic Alloy
- PM Sintered Component
- Carbide/Hard Brittle Material

## DCMT / DCMW







● M-Class SumiDia (PCD, Regrindable Type)

Shape	ISO Cat. No.	RE	Material																									
			Coated								Uncoated																	
			CBN																									
			BNC2115	BNC2125	BNC2010	BNC2020	BNC100	BNC160	BNC200	BNC300	BNC500	BNC8115	BN1000	BN2000	BNX10	BNX20	BNX25	BN300	BN350	BN7000	BN7115	BNS8125	NCB100	DA90	DA150	DA1000	NPD10	
 	DCMT 070201	0,1																										
	DCMT 070202	0,2																								○		
	DCMT 070204	0,4																								○		
	DCMT 11T302	0,2																								○		
	DCMT 11T304	0,4																								○		
	DCMT 11T308	0,8																								○		

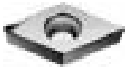
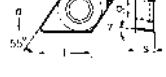
● M-Class SumiDia (PCD, NF Type)

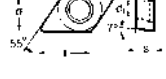
Shape	ISO Cat. No.	RE	Material																									
			CBN																									
			BNC2115	BNC2125	BNC2010	BNC2020	BNC100	BNC160	BNC200	BNC300	BNC500	BNC8115	BN1000	BN2000	BNX10	BNX20	BNX25	BN300	BN350	BN7000	BN7115	BNS8125	NCB100	DA90	DA150	DA1000	NPD10	
 	DCMT 070201 NF	0,1																										
	DCMT 070202 NF	0,2																										
	DCMT 070204 NF	0,4																										
	DCMT 070208 NF	0,8																										
	DCMT 11T301 NF	0,1																										
	DCMT 11T302 NF	0,2																										
	DCMT 11T304 NF	0,4																										
	DCMT 11T308 NF	0,8																										

● M-Class SumiDIA (PCD, One-Use "Break Master" Type)

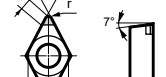
Shape	ISO Cat. No.	RE	Material																									
			CBN																									
			BNC2115	BNC2125	BNC2010	BNC2020	BNC100	BNC160	BNC200	BNC300	BNC500	BNC8115	BN1000	BN2000	BNX10	BNX20	BNX25	BN300	BN350	BN7000	BN7115	BNS8125	NCB100	DA90	DA150	DA1000	NPD10	
<b>Break Master - DM</b>  	DCMT 070202 L-DM NU	0,2																										
	DCMT 070204 L-DM NU	0,4																										
	DCMT 11T304 L-DM NU	0,4																										
<b>Break Master - DM</b>  	DCMT 070202 R-DM NU	0,2																										
	DCMT 070204 R-DM NU	0,4																										
	DCMT 11T302 R-DM NU	0,2																										
	DCMT 11T304 R-DM NU	0,4																										
<b>Break Master - LD</b>  	DCMT 070202 N-LD NF	0,2																										
	DCMT 070204 N-LD NF	0,4																										
	DCMT 11T302 N-LD NF	0,2																										
	DCMT 11T304 N-LD NF	0,4																										
	DCMT 11T308 N-LD NF	0,8																										
<b>Break Master - GD</b>  	DCMT 070202 N-GD NF	0,2																										
	DCMT 070204 N-GD NF	0,4																										
	DCMT 11T302 N-GD NF	0,2																										
	DCMT 11T304 N-GD NF	0,4																										
	DCMT 11T308 N-GD NF	0,8																										

● M-Class SumiDia (PCD, NF Type)

Shape	ISO Cat. No.	RE	Material																									
			CBN																									
			BNC2115	BNC2125	BNC2010	BNC2020	BNC100	BNC160	BNC200	BNC300	BNC500	BNC8115	BN1000	BN2000	BNX10	BNX20	BNX25	BN300	BN350	BN7000	BN7115	BNS8125	NCB100	DA90	DA150	DA1000	NPD10	
	DCMW 070202 NF	0,2																										
	DCMW 070204 NF	0,4																										
	DCMW 11T302 NF	0,2																										
	DCMW 11T304 NF	0,4																										
	DCMW 11T308 NF	0,8																										

● M-Class SumiDia (PCD, Binderless)

Shape	ISO Cat. No.	RE	Material																									
			CBN																									
			BNC2115	BNC2125	BNC2010	BNC2020	BNC100	BNC160	BNC200	BNC300	BNC500	BNC8115	BN1000	BN2000	BNX10	BNX20	BNX25	BN300	BN350	BN7000	BN7115	BNS8125	NCB100	DA90	DA150	DA1000	NPD10	
	DCMW 070202 RH	0,2																										
	DCMW 070204 RH	0,4																										
	DCMW 11T302 RH	0,2																										
	DCMW 11T304 RH	0,4																										
	DCMW 11T308 RH	0,8																										

● = Euro stock  
 ○ = Stock item in Japan

 L8, L9 Edge Specification of SUMIBORON Inserts

- C
- D
- R
- S
- T
- V
- W
- Z

Sumiboron / Sumidia Inserts



# SUMIBORON / SUMIDIA Indexable Inserts

DN-- Type neg. Inserts

55° Diamond Type 0° Relief With Insert Hole

Coated

Dimensions (mm)				
DN--	L	IC	S	D <sub>1</sub>
1104--	11,6	9,525	4,76	3,81
1504--	15,5	12,7	4,76	5,16
1506--	15,5	12,7	6,35	5,16

- H** Hardened Steel
- K** Cast Iron
- N** Non-Ferrous Metal
- S** Exotic Alloy
- PM** Sintered Component
- Carbide/Hard Brittle Material

## DNGA

### ● G-Class SumiBoron (CBN, One-Use Multi-Corner Type)

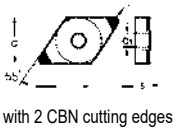
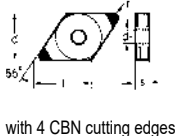
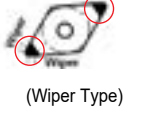
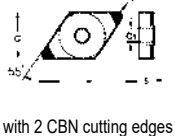
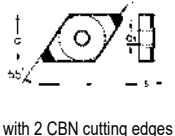
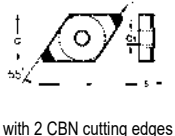
Shape	ISO Cat. No.	RE	Coated												Uncoated												
			CBN												Uncoated												
			BNC2115	BNC2125	BNC2010	BNC2020	BNC100	BNC160	BNC200	BNC300	BNC500	BNC8115	BN1000	BN2000	BNX10	BNX20	BNX25	BN300	BN350	BN7000	BN7115	BNS8125	NCB100	DA90	DA150	DA1000	NPD10
 <p>with 2 CBN cutting edges</p>	DNGA 110404 NC2	0,4	●	●	○	●		●																			
	DNGA 110408 NC2	0,8	●	●	○	●		●																			
 <p>with 4 CBN cutting edges</p> <p>Standard - Normal cut geometry</p>	DNGA 150404 NC2	0,4	○	○	○	○																					
	DNGA 150408 NC2	0,8	○	○	○	○																					
	DNGA 150412 NC2	1,2	○	○	○	○																					
	DNGA 150416 NC2	1,6	○	○	○	○		○	○	○																	
	DNGA 150420 NC2	2,0	○	○	○	○		○	○	○																	
	DNGA 150424 NC2	2,4	○	○	○	○		○	○	○																	
	DNGA 150604 NC4	0,4	●	●	●	●	●	●	●	●																	
	DNGA 150608 NC4	0,8	●	●	●	●	●	●	●	●																	
	DNGA 150612 NC4	1,3	●	●	●	●	●	●	●	●																	
	 <p>(Wiper Type)</p>	DNGA 150404 NC-WG4	0,4	○	○	○		○	○																		
DNGA 150408 NC-WG4		0,8	○	○	○		○	○																			
DNGA 150604 NC-WG4		0,4	●	●	●	●	●	●	●																		
DNGA 150608 NC-WG4		0,8	●	●	●	●	●	●	●																		
DNGA 150612 NC-WG4		1,2	●	●	●	●	●	●	●																		
DNGA 150404 NC-WH4		0,4	○	○				○	○																		
 <p>with 2 CBN cutting edges</p> <p>LE - Type Low cutting force</p>	DNGA 150404 LE-NC2	0,4		○																							
	DNGA 150408 LE-NC2	0,8		○																							
	DNGA 150412 LE-NC2	1,2		○																							
 <p>with 2 CBN cutting edges</p> <p>LT - Type Sharp cutting edge</p>	DNGA 150604 LE-NC2	0,4		●																							
	DNGA 150608 LE-NC2	0,8		●																							
	DNGA 150612 LE-NC2	1,2		●																							
	DNGA 150402 LT-NC2	0,2			○																						
	DNGA 150404 LT-NC2	0,4			○																						
	DNGA 150408 LT-NC2	0,8			○																						
 <p>with 2 CBN cutting edges</p>	DNGA 150412 LT-NC2	1,2			○																						
	DNGA 150604 LT-NC2	0,4			●																						
	DNGA 150608 LT-NC2	0,8			●																						
DNGA 150612 LT-NC2	1,2			●																							

● = Euro stock  
○ = Stock item in Japan

To be replaced by new item

 L8, L9 Edge Specification of SUMIBORON Inserts

55° Diamond Type      0° Relief  
With Insert Hole



Coated

Dimensions (mm)				
DN_	L	IC	S	D <sub>1</sub>
1504--	15,5	12,7	4,76	5,16
1506--	15,5	12,7	6,35	5,16

- H** Hardened Steel
- K** Cast Iron
- N** Non-Ferrous Metal
- S** Exotic Alloy
- PM** Sintered Component
- Carbide/Hard Brittle Material

## DNGA / DNGG

● G-Class SumiBoron (CBN, One-Use Multi-Corner Type)

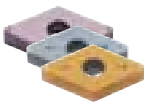
Shape	ISO Cat. No.	RE	Coated												Uncoated											
			CBN												Uncoated											
			BNC2115	BNC2125	BNC2010	BNC2020	BNC100	BNC160	BNC200	BNC300	BNC500	BNC8115	BN1000	BNX10	BNX20	BNX25	BN300	BN350	BN7000	BN7115	BNS8125	NCB100	DA90	DA150	DA1000	NPD10
 LS - Type Low cutting force	DNGA 150402 LS-NC2 DNGA 150404 LS-NC2 DNGA 150408 LS-NC2 DNGA 150412 LS-NC2  DNGA 150604 LS-NC2 DNGA 150608 LS-NC2 DNGA 150612 LS-NC2	0,2 0,4 0,8 1,2	○	○				○																		
	DNGA 150408 LS-NC4	0,8					○																			
 ES - Type Crater wear stability	DNGA 150604 ES-NC2 DNGA 150608 ES-NC2 DNGA 150612 ES-NC2	0,4 0,8 1,2				●																				
	DNGA 150404 ES-NC4 DNGA 150408 ES-NC4 DNGA 150412 ES-NC4	0,4 0,8 1,2			○																					
 HS - Type Strong cutting edge	DNGA 150604 HS-NC2 DNGA 150608 HS-NC2 DNGA 150612 HS-NC2	0,4 0,8 1,2	●	●	●	●	●	●																		
	DNGA 150404 HS-NC4 DNGA 150408 HS-NC4 DNGA 150412 HS-NC4	0,4 0,8 1,2	○	○	○	○	○	○	○	○																
 Break Master - FV, LV, SV  CBN with chipbreaker	DNGG 150404 N-FV NC4 DNGG 150408 N-FV NC4 DNGG 150412 N-FV NC4	0,4 0,8 1,2	○	○	○			○	○																	
	DNGG 150604 N-FV NC4 DNGG 150608 N-FV NC4 DNGG 150612 N-FV NC4	0,4 0,8 1,2		●	●			●	●																	
	DNGG 150404 N-LV NC4 DNGG 150408 N-LV NC4 DNGG 150412 N-LV NC4	0,4 0,8 1,2	○	○	○	○			○	○																
	DNGG 150604 N-LV NC4 DNGG 150608 N-LV NC4 DNGG 150612 N-LV NC4	0,4 0,8 1,2		●	●	●			●	●																
	DNGG 150408 N-SV NC4 DNGG 150412 N-SV NC4	0,8 1,2	○	○	○	○			○																	
	DNGG 150608 N-SV NC4	0,8		●	●			●																		

● = Euro stock  
○ = Stock item in Japan

 Edge Specification of SUMIBORON Inserts

- C
- D
- R
- S
- T
- V
- W
- Z

Sumiboron / Sumidia  
Inserts

# SUMIBORON / SUMIDIA Indexable Inserts

DN-- Type neg. Inserts

55° Diamond Type 0° Relief With Insert Hole



Uncoated

Dimensions (mm)				
DN--	L	IC	S	D <sub>1</sub>
1504--	15,5	12,7	4,76	5,16
1506--	15,5	12,7	6,35	5,16

- H** Hardened Steel
- K** Cast Iron
- N** Non-Ferrous Metal
- S** Exotic Alloy
- PM** Sintered Component
- Carbide/Hard Brittle Material

## DNGA / DNGM

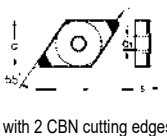
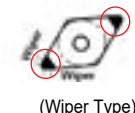
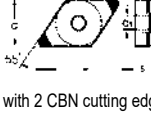
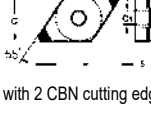
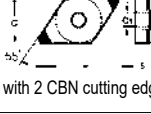
### ● G-Class SumiBoron (CBN, One-Use Multi-Corner Type)

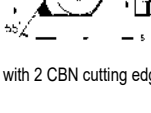
Shape	ISO Cat. No.	RE	CBN													Uncoated													
			BNC2115	BNC2125	BNC2010	BNC2020	BNC100	BNC160	BNC200	BNC300	BNC500	BNC8115	BN1000	BN2000	BNX10	BNX20	BNX25	BN300	BN350	BN7000	BN7115	BNS8125	NCB100	DA90	DA150	DA1000	NPD10		
 <p>DNGA 150404 NU2 DNGA 150408 NU2 DNGA 150412 NU2</p> <p>with 2 CBN cutting edges</p>		0,4																											
		0,8																											
		1,2																											
 <p>DNGA 150404 NU-WG2</p> <p>(Wiper Type)</p>		0,4																											
		0,8																											
 <p>DNGA 150408 LF-NU2</p> <p>LF - Type Low cutting force</p> <p>with 2 CBN cutting edges</p>		0,8																											
		1,2																											
 <p>DNGA 150404 LT-NU2 DNGA 150408 LT-NU2 DNGA 150412 LT-NU2</p> <p>LT - Type Sharp cutting edge</p> <p>with 2 CBN cutting edges</p>		0,4																											
		0,8																											
		1,2																											
 <p>DNGA 150404 HS-NU2 DNGA 150408 HS-NU2 DNGA 150412 HS-NU2</p> <p>HS - Type Strong cutting edge</p> <p>with 2 CBN cutting edges</p>		0,4																											
		0,8																											
		1,2																											
 <p>DNGM 150404 N-LV NU2 DNGM 150408 N-LV NU2 DNGM 150412 N-LV NU2</p> <p>Break Master - LV</p> <p>with 2 CBN cutting edges</p>		0,4																											
		0,8																											
 <p>DNGM 150608 N-LV NU2</p> <p>CBN with chipbreaker</p> <p>with 2 CBN cutting edges</p>		1,2																											
		0,8																											

### ● G-Class SumiBoron (CBN, Binderless)

 <p>DNGA 150404 NU DNGA 150408 NU DNGA 150412 NU</p>		0,4																										
		0,8																										
		1,2																										

● = Euro stock  
○ = Stock item in Japan

▲ = To be replaced by new item

 L8, L9 Edge Specification of SUMIBORON Inserts

55° Diamond Type 0° Relief

Coated / Uncoated

Dimensions (mm)				
DN_	L	IC	S	D <sub>1</sub>
1103--		9,525	3,18	-
1506--	15,5	12,7	4,76	5,16
1506--	15,5	12,7	6,35	5,16

- H** Hardened Steel
- K** Cast Iron
- N** Non-Ferrous Metal
- S** Exotic Alloy
- PM** Sintered Component
- Carbide/Hard Brittle Material

## DNGN

● G-Class SumiBoron (Solid CBN Type)

Shape	ISO Cat. No.	RE	Dimensions (mm)																								
			Coated								Uncoated																
			CBN																								
			BNC2115	BNC2125	BNC2010	BNC2020	BNC100	BNC160	BNC200	BNC300	BNC500	BNC8115	BN1000	BN2000	BNX10	BNX20	BNX25	BN300	BN350	BN7000	BN7115	BNS8125	NCB100	DA90	DA150	DA1000	NPD10
	<b>DNGN 110308</b> <b>DNGN 110312</b>	0,8 1,2										●										●					

## DNMA

● M-Class SumiBoron (CBN, Regrindable Type)

Shape	ISO Cat. No.	RE	Dimensions (mm)																									
			Coated								Uncoated																	
			CBN																									
			BNC2115	BNC2125	BNC2010	BNC2020	BNC100	BNC160	BNC200	BNC300	BNC500	BNC8115	BN1000	BN2000	BNX10	BNX20	BNX25	BN300	BN350	BN7000	BN7115	BNS8125	NCB100	DA90	DA150	DA1000	NPD10	
	<b>DNMA 150404</b> <b>DNMA 150604</b> <b>DNMA 150608</b> <b>DNMA 150612</b>	0,4 0,4 0,8 1,2														○												

● M-Class SumiBoron (CBN, One-use Type)

Shape	ISO Cat. No.	RE	Dimensions (mm)																									
			Coated								Uncoated																	
			CBN																									
			BNC2115	BNC2125	BNC2010	BNC2020	BNC100	BNC160	BNC200	BNC300	BNC500	BNC8115	BN1000	BN2000	BNX10	BNX20	BNX25	BN300	BN350	BN7000	BN7115	BNS8125	NCB100	DA90	DA150	DA1000	NPD10	
	<b>DNMA 150408 NS</b>	0,8														○												
	<b>DNMA 150604 NS</b> <b>CNMA 150608 NS</b>	0,4 0,8														●												
	<b>DNMA 150401 NU</b> <b>DNMA 150402 NU</b> <b>DNMA 150404 NU</b> <b>DNMA 150408 NU</b> <b>DNMA 150412 NU</b>	0,1 0,2 0,4 0,8 1,2													○	○	○	○	○	○								
	<b>DNMA 150604 NU</b> <b>DNMA 150608 NU</b> <b>DNMA 150612 NU</b>	0,4 0,8 1,2													●	●	●	●	●	●	●							

● M-Class SumiDia (PCD, NF Type)

Shape	ISO Cat. No.	RE	Dimensions (mm)																									
			Coated								Uncoated																	
			CBN																									
			BNC2115	BNC2125	BNC2010	BNC2020	BNC100	BNC160	BNC200	BNC300	BNC500	BNC8115	BN1000	BN2000	BNX10	BNX20	BNX25	BN300	BN350	BN7000	BN7115	BNS8125	NCB100	DA90	DA150	DA1000	NPD10	
	<b>DNMA 150408 NF</b> <b>DNMA 150412 NF</b>	0,8 1,2																							○	○		

● M-Class SumiBoron (CBN, Binderless)

Shape	ISO Cat. No.	RE	Dimensions (mm)																									
			Coated								Uncoated																	
			CBN																									
			BNC2115	BNC2125	BNC2010	BNC2020	BNC100	BNC160	BNC200	BNC300	BNC500	BNC8115	BN1000	BN2000	BNX10	BNX20	BNX25	BN300	BN350	BN7000	BN7115	BNS8125	NCB100	DA90	DA150	DA1000	NPD10	
	<b>DNMA 150408 RH</b> <b>DNMA 150412 RH</b>	0,8 1,2																										○

● = Euro stock  
○ = Stock item in Japan

▲ = To be replaced by new item

L8, L9 Edge Specification of SUMIBORON Inserts

- C**
- D**
- R**
- S**
- T**
- V**
- W**
- Z**

# SUMIBORON / SUMIDIA Indexable Inserts

RN-- neg. Type Inserts

Round Type 0° Relief  
Without Insert Hole

Coated / Uncoated

Dimensions (mm)				
RN--	L	IC	S	D <sub>1</sub>
0903--	9,525	9,525	3,18	-
1203--	12,7	12,7	3,18	-
1204--	12,7	12,7	4,76	-

- H Hardened Steel
- K Cast Iron
- N Non-Ferrous Metal
- S Exotic Alloy
- PM Sintered Component
- Carbide/Hard Brittle Material

## RNGN ○○○○○

		H Coated		K KH		H Uncoated		K PM KH S		N																	
		CBN						Uncoated		Uncoated																	
		CBN						PCD		Sumidia																	
	RE	BNC2115	BNC2125	BNC2010	BNC2020	BNC100	BNC160	BNC200	BNC300	BNC500	BNC8115	BN1000	BN2000	BNX10	BNX20	BNX25	BN300	BN350	BN7000	BN7115	BNS8125	NCB100	DA90	DA150	DA1000	NPD10	
	-									●											●						
	-									●											●						
	-									●											●						

● G-Class SumiBoron (CBN, Full Top Type)

Shape	ISO Cat. No.	RE																												
	RNGN 090300 RNGN 120300 RNGN 120400	- - -																												

● M-Class SumiBoron (CBN, One-Use Type)

Shape	ISO Cat. No.	RE																												
	RNGN 090300 B RNGN 120400 B	- -																												

C

D

R

S

T

V

W

Z

SumiBoron / SumiDia  
Inserts

M22

● = Euro stock  
○ = Stock item in Japan

 L8, L9 Edge Specification of SUMIBORON Inserts

Square Type 7°/0° Relief  
With Insert Hole



Coated / Uncoated

Dimensions (mm)				
SN--	L	IC	S	D <sub>1</sub>
09T3--	9,525	9,525	3,97	4,4
1204--	12,7	12,7	4,76	5,16

- H Hardened Steel
- K Cast Iron
- N Non-Ferrous Metal
- S Exotic Alloy
- PM Sintered Component
- Carbide/Hard Brittle Material

## SCGW / SNGA



● G-Class SumiBoron (CBN, One-Use Multi-Corner Type)

Shape	ISO Cat. No.	RE	Coated												Uncoated														
			CBN												Uncoated														
			BNC2115	BNC2125	BNC2010	BNC2020	BNC100	BNC160	BNC200	BNC300	BNC500	BNC8115	BN1000	BN2000	BNX10	BNX20	BNX25	BN300	BN350	BN7000	BN7115	BNS8125	NCB100	DA90	DA150	DA1000	NPD10		
 Standard - Normal cut geometry with 2 CBN cutting edges with 4 CBN cutting edges	SNGA 120408 NC2	0,8										○																	
	SNGA 120404 NC4	0,4	○	○																									
	SNGA 120408 NC4	0,8	○	●						●	●																		
	SNGA 120412 NC4	1,2	●	●		○				●	●																		
 HS - Type Strong cutting edge with 2 CBN cutting edges	SNGA 120408 HS-NC2	0,8																											
	SNGA 120412 HS-NC2	1,2																											

● G-Class SumiBoron (CBN, One-Use Type)

Shape	ISO Cat. No.	RE	BNC2115	BNC2125	BNC2010	BNC2020	BNC100	BNC160	BNC200	BNC300	BNC500	BNC8115	BN1000	BN2000	BNX10	BNX20	BNX25	BN300	BN350	BN7000	BN7115	BNS8125	NCB100	DA90	DA150	DA1000	NPD10	
 SCGW 09T304 NU SCGW 09T308 NU		0,4																										
		0,8															●											

● G-Class SumiBoron (CBN, One-Use Multi-Corner Type)

Shape	ISO Cat. No.	RE	BNC2115	BNC2125	BNC2010	BNC2020	BNC100	BNC160	BNC200	BNC300	BNC500	BNC8115	BN1000	BN2000	BNX10	BNX20	BNX25	BN300	BN350	BN7000	BN7115	BNS8125	NCB100	DA90	DA150	DA1000	NPD10		
 SNGA 120404 NU2 SNGA 120408 NU2 SNGA 120412 NU2 with 2 CBN cutting edges		0,4																											
		0,8																											
		1,2																											
 SNGA 120404 LT-NU2 SNGA 120408 LT-NU2 SNGA 120412 LT-NU2 with 2 CBN cutting edges		0,4																											
		0,8																											
		1,2																											
 SNGA 120404 HS-NU2 SNGA 120408 HS-NU2 SNGA 120412 HS-NU2 with 2 CBN cutting edges		0,4																											
		0,8																											
		1,2																											

● = Euro stock  
 ○ = Stock item in Japan





# SUMIBORON / SUMIDIA Indexable Inserts

SN-- neg. Type Inserts

Square Type

0° Relief  
Without Insert Hole

Coated / Uncoated

Dimensions (mm)				
SN--	L	IC	S	D <sub>1</sub>
0903--	9,525	9,525	3,18	--
1204--	12,7	12,7	4,76	--

**H** Hardened Steel  
**K** Cast Iron  
**N** Non-Ferrous Metal  
**S** Exotic Alloy  
**PM** Sintered Component  
**■** Carbide/Hard Brittle Material

## SNGN / SNGX

### ● G-Class SumiBoron (Solid CBN Type)

Shape	ISO Cat. No.	RE	Coated										Uncoated														
			CBN										Uncoated														
			BNC2115	BNC2125	BNC2010	BNC2020	BNC100	BNC160	BNC200	BNC300	BNC500	BNC8115	BN1000	BN2000	BNX10	BNX20	BNX25	BN300	BN350	BN7000	BN7115	BNS8125	NCB100	DA90	DA150	DA1000	NPD10
	SNGN 090308 SNGN 090312	0,8 1,2										●										●					
	SNGN 120308 SNGN 120312	0,8 1,2										●										●					
	SNGN 120408 SNGN 120412 SNGN 120416 SNGN 120420	0,8 1,2 1,6 2,0										●										●					

### ● G-Class SumiBoron (Solid CBN, "Dimple" Type)

Shape	ISO Cat. No.	RE	Coated										Uncoated														
			CBN										Uncoated														
			BNC2115	BNC2125	BNC2010	BNC2020	BNC100	BNC160	BNC200	BNC300	BNC500	BNC8115	BN1000	BN2000	BNX10	BNX20	BNX25	BN300	BN350	BN7000	BN7115	BNS8125	NCB100	DA90	DA150	DA1000	NPD10
	SNGX 120412 SNGX 120416	1,2 1,6										●										●					

Square Type

0° Relief  
With Insert Hole

Uncoated

Dimensions (mm)				
SN--	L	IC	S	D <sub>1</sub>
0903--	9,525	9,525	3,18	--
1204--	12,7	12,7	4,76	--

**H**  
**K**  
**N**  
**S**  
**PM**

## SNMA

### ● M-Class SumiBoron (CBN, One-Use Type)

Shape	ISO Cat. No.	RE	Coated										Uncoated														
			CBN										Uncoated														
			BNC2115	BNC2125	BNC2010	BNC2020	BNC100	BNC160	BNC200	BNC300	BNC500	BNC8115	BN1000	BN2000	BNX10	BNX20	BNX25	BN300	BN350	BN7000	BN7115	BNS8125	NCB100	DA90	DA150	DA1000	NPD10
	SNMA 120408 NS SNMA 120412 NS	0,8 1,2															●										
	SNMA 120408 NU SNMA 120412 NU	0,8 1,2											●		○			▲		●							

### ● M-Class SumiDia (PCD, NF Type)

Shape	ISO Cat. No.	RE	Coated										Uncoated														
			CBN										Uncoated														
			BNC2115	BNC2125	BNC2010	BNC2020	BNC100	BNC160	BNC200	BNC300	BNC500	BNC8115	BN1000	BN2000	BNX10	BNX20	BNX25	BN300	BN350	BN7000	BN7115	BNS8125	NCB100	DA90	DA150	DA1000	NPD10
	SNMA 120408 NF SNMA 120412 NF	0,8 1,2																						○			

### ● M-Class SumiDIA (PCD, Binderless)

Shape	ISO Cat. No.	RE	Coated										Uncoated														
			CBN										Uncoated														
			BNC2115	BNC2125	BNC2010	BNC2020	BNC100	BNC160	BNC200	BNC300	BNC500	BNC8115	BN1000	BN2000	BNX10	BNX20	BNX25	BN300	BN350	BN7000	BN7115	BNS8125	NCB100	DA90	DA150	DA1000	NPD10
	SNMA 120408 RH SNMA 120412 RH	0,8 1,2																									○

● = Euro stock  
○ = Stock item in Japan

▲ = To be replaced by new item

L8, L9 Edge Specification of SUMIBORON Inserts

60° Triangle Type 5° Relief

Coated / Uncoated

Dimensions (mm)				
TBGN	L	IC	S	D <sub>1</sub>
0601--	6,9	3,97	1,59	-
TBGW				
0601--	6,9	3,97	1,59	2,8

- H** Hardened Steel
- K** Cast Iron
- N** Non-Ferrous Metal
- S** Exotic Alloy
- PM** Sintered Component
- Carbide/Hard Brittle Material

## TBGN / TBGW

● G-Class SumiBoron (CBN, Full Top Type)

Shape	ISO Cat. No.	RE	Material																								
			Coated								Uncoated																
			CBN																								
			BNC2115	BNC2125	BNC2010	BNC2020	BNC100	BNC160	BNC200	BNC300	BNC500	BNC8115	BN1000	BN2000	BNX10	BNX20	BNX25	BN300	BN350	BN7000	BN7115	BNS8125	NCB100	DA90	DA150	DA1000	NPD10
	TBGN 060102 B TBGN 060104 B	0,2 0,4							●					●	▲	●		▲		○						○	

● G-Class SumiDIA (PCD, NF Type)

Shape	ISO Cat. No.	RE	Material																									
			Coated								Uncoated																	
			CBN																									
			BNC2115	BNC2125	BNC2010	BNC2020	BNC100	BNC160	BNC200	BNC300	BNC500	BNC8115	BN1000	BN2000	BNX10	BNX20	BNX25	BN300	BN350	BN7000	BN7115	BNS8125	NCB100	DA90	DA150	DA1000	NPD10	
	TBGN 060102 NF TBGN 060104 NF	0,2 0,4																									○	●

● G-Class SumiDIA (PCD, NF Type)

Shape	ISO Cat. No.	RE	Material																									
			Coated								Uncoated																	
			CBN																									
			BNC2115	BNC2125	BNC2010	BNC2020	BNC100	BNC160	BNC200	BNC300	BNC500	BNC8115	BN1000	BN2000	BNX10	BNX20	BNX25	BN300	BN350	BN7000	BN7115	BNS8125	NCB100	DA90	DA150	DA1000	NPD10	
	TBGW 060102 NF TBGW 060104 NF	0,2 0,4																									●	●

● = Euro stock  
○ = Stock item in Japan

▲ = To be replaced by new item

L8, L9 Edge Specification of SUMIBORON Inserts

- C
- D
- R
- S
- T
- V
- W
- Z

# SUMIBORON / SUMIDIA Indexable Inserts

TC-- Type 7° pos. Inserts

60° Triangle Type 7° Relief  
With Insert Hole





Coated / Uncoated

Dimensions (mm)				
TC--	L	IC	S	D <sub>1</sub>
0902--	9,62	5,56	2,38	2,5
1102--	11,0	6,35	2,38	2,8
16T3--	16,5	9,525	3,97	4,3

- H** Hardened Steel
- K** Cast Iron
- N** Non-Ferrous Metal
- S** Exotic Alloy
- PM** Sintered Component
- Carbide/Hard Brittle Material

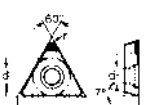

## TCGW

● G-Class SumiBoron (CBN, One-Use Type+Multi-Corner)

Shape	ISO Cat. No.	RE	Coated			Uncoated																											
			BNC2115	BNC2125	BNC2010	BNC2020	BNC100	BNC160	BNC200	BNC300	BNC500	BNC8115	BN1000	BN2000	BNX10	BNX20	BNX25	BN300	BN350	BN7000	BN7115	BNS8125	NCB100	DA90	DA150	DA1000	NPD10						
  TCGW 090204 NC TCGW 090208 NC  TCGW 110202 NC TCGW 110204 NC TCGW 110208 NC		0,4	●	●	●																												
		0,8	●	●	●																												
		0,2	●	●	●																												
		0,4	●	●	●																												
  TCGW 16T304 NC3 TCGW 16T308 NC3  with 3 CBN cutting edges		0,4	●	●	●																												
		0,8	●	●	●																												
  TCGW 090204 NU TCGW 090208 NU  TCGW 110202 NU TCGW 110204 NU TCGW 110208 NU  TCGW 16T304 NU TCGW 16T308 NU		0,4																															
		0,8																															
		0,2																															
		0,4																															
		0,8																															
		0,4																															

## TCMT

● M-Class SumiDia (PCD, NF Type)

Shape	ISO Cat. No.	RE	Coated			Uncoated																												
			BNC2115	BNC2125	BNC2010	BNC2020	BNC100	BNC160	BNC200	BNC300	BNC500	BNC8115	BN1000	BN2000	BNX10	BNX20	BNX25	BN300	BN350	BN7000	BN7115	BNS8125	NCB100	DA90	DA150	DA1000	NPD10							
  TCMT 090202 NF TCMT 090204 NF  TCMT 110201 NF TCMT 110202 NF TCMT 110204 NF		0,2																																
		0,4																																
		0,1																																
		0,2																																
	0,4																																	

● = Euro stock  
○ = Stock item in Japan

▲ = To be replaced by new item

 L8, L9 Edge Specification of SUMIBORON Inserts

C  
D  
R  
S

T  
V  
W  
Z

SumiBoron / SumiDia  
Inserts



# SUMIBORON / SUMIDIA Indexable Inserts

TN-- Type neg. Inserts

60° Triangle Type 0° Relief With Insert Hole

Coated

Dimensions (mm)				
TN--	L	IC	S	D <sub>1</sub>
1604--	16,5	9,525	4,76	3,81

- H** Hardened Steel
- K** Cast Iron
- N** Non-Ferrous Metal
- S** Exotic Alloy
- PM** Sintered Component
- Carbide/Hard Brittle Material

## TNGG ○○○○○○

● G-Class SumiBoron (CBN, One-Use Multi-Corner Type)

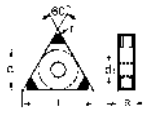
Shape	ISO Cat. No.	RE	H		K KH		H		K PM KH S		N																		
			Coated				Uncoated				Uncoated																		
			CBN																										
			BNC2115	BNC2125	BNC2010	BNC2020	BNC100	BNC160	BNC200	BNC300	BNC500	BNC8115	BN1000	BN2000	BNX10	BNX20	BNX25	BN300	BN350	BN7000	BN7115	BNS8125	NCB100	DA90	DA150	DA1000	NPD10		
<p>Break Master - FV, LV, SV</p>  <p>CBN with chipbreaker</p>  <p>with 6 CBN cutting edges</p>	TNGG 160404 N-FV NC6	0,4	○	○	●	●																							
	TNGG 160408 N-FV NC6	0,8	○	○	●	●	●																						
	TNGG 160412 N-FV NC6	1,2	○	○	●	●	●																						
	TNGG 160404 N-LV NC6	0,4	○	○	●	●	○																						
	TNGG 160408 N-LV NC6	0,8	●	●	●	●	●	●	●	●																			
	TNGG 160412 N-LV NC6	1,2	●	●	●	●	●	●	●	●																			
	TNGG 160408 N-SV NC6	0,8	●	●	●	●	●		●																				
	TNGG 160412 N-SV NC6	1,2	○	○	○																								

C

D

R

S

T

V

W

Z

SumiBoron / SumiDia Inserts

● = Euro stock  
○ = Stock item in Japan

60° Triangle Type 0° Relief

Coated / Uncoated

Dimensions (mm)				
TN_	L	IC	S	D <sub>1</sub>
1103--		6,35	3,18	-
1604--	16,5	9,525	4,76	3,81

- H** Hardened Steel
- K** Cast Iron
- N** Non-Ferrous Metal
- S** Exotic Alloy
- PM** Sintered Component
- Carbide/Hard Brittle Material

## TNGA / TNGM

● G-Class SumiBoron (CBN, One-Use Multi-Corner Type)

Shape	ISO Cat. No.	RE	Materials																									
			Coated								Uncoated																	
			CBN																									
			BNC2115	BNC2125	BNC2010	BNC2020	BNC100	BNC160	BNC200	BNC300	BNC500	BNC8115	BN1000	BN2000	BNX10	BNX20	BNX25	BN300	BN350	BN7000	BN7115	BNS8125	NCB100	DA90	DA150	DA1000	NPD10	
 TNGA 160404 NU3 TNGA 160408 NU3 TNGA 160412 NU3 with 3 CBN cutting edges		0,4												○	○													
		0,8													○	○												
		1,2																										
 TNGA 160404 T NU3 TNGA 160408 T NU3 with 3 CBN cutting edges		0,4												○	○													
		0,8													○	○												
 LF / LE - Type Sharp cutting edge with 3 CBN cutting edges		0,4																			○	○						
		0,8																				○	○					
 LE - Type Sharp cutting edge with 3 CBN cutting edges		0,4																			○	○						
		0,8																				○	○					
 LS - Type Low cutting force with 3 CBN cutting edges		0,4																			○							
 HT, HS, US - Type Strong cutting edge with 3 CBN cutting edges		0,8																			○							
		0,4																				○						
		0,8																				○						
		1,6																				●						
 US - Type Strong cutting edge with 3 CBN cutting edges		0,4																			○							
 Break Master - LV CBN with chipbreaker with 3 CBN cutting edges		0,4												○														

## TNGN

● G-Class SumiBoron (Solid CBN Type, without Hole)

Shape	ISO Cat. No.	RE	Materials																									
			Coated								Uncoated																	
			CBN																									
			BNC2115	BNC2125	BNC2010	BNC2020	BNC100	BNC160	BNC200	BNC300	BNC500	BNC8115	BN1000	BN2000	BNX10	BNX20	BNX25	BN300	BN350	BN7000	BN7115	BNS8125	NCB100	DA90	DA150	DA1000	NPD10	
 TNGN 110308 TNGN 110312		0,8																										
		1,2																										
 TNGN 160408 TNGN 160412 TNGN 160416 TNGN 160420		0,8																										
		1,2																										
		1,6																										
		2,0																										

● = Euro stock  
○ = Stock item in Japan

L8, L9 Edge Specification of SUMIBORON Inserts

- 
- 
- 
- 
- 
- 
- 
- 

SumiBoron / Sumidia Inserts



# SUMIBORON / SUMIDIA Indexable Inserts

TN-- Type neg. Inserts

60° Triangle Type 0° Relief  
With Insert Hole

Uncoated

Dimensions (mm)				
TN--	L	IC	S	D <sub>1</sub>
1604--	16,5	9,525	4,76	3,81

- H** Hardened Steel
- K** Cast Iron
- N** Non-Ferrous Metal
- S** Exotic Alloy
- PM** Sintered Component
- Carbide/Hard Brittle Material

## TNMA ○○○○○○

● M-Class SumiBoron (CBN, Regrindable Type)

Shape	ISO Cat. No.	RE	Material																										
			BNC2115	BNC2125	BNC2010	BNC2020	BNC100	BNC160	BNC200	BNC300	BNC500	BNC8115	BN1000	BN2000	BNX10	BNX20	BNX25	BN300	BN350	BN7000	BN7115	BNS8125	NCB100	DA90	DA150	DA1000	NPD10		
	TNMA 160404 TNMA 160408	0,4																											
		0,8														●		▲											

● M-Class SumiBoron (CBN, One-Use Type)

	TNMA 160401 NU TNMA 160402 NU TNMA 160404 NU TNMA 160408 NU TNMA 160412 NU	0,1																												
		0,2																												
		0,4																												
		0,8																												
		1,2																												
	TNMA 160408 NS	0,8																												

## TNMX ○○○○○○

● M-Class SumiDia (PCD, NF Type)

Shape	ISO Cat. No.	RE	Material																										
			BNC2115	BNC2125	BNC2010	BNC2020	BNC100	BNC160	BNC200	BNC300	BNC500	BNC8115	BN1000	BN2000	BNX10	BNX20	BNX25	BN300	BN350	BN7000	BN7115	BNS8125	NCB100	DA90	DA150	DA1000	NPD10		
	TNMX 160404 NF TNMX 160408 NF	0,4																											
		0,8																										○	○

● = Euro stock  
○ = Stock item in Japan

▲ = To be replaced by new item

L8, L9 Edge Specification of SUMIBORON Inserts

C  
D  
R  
S  
T  
V  
W  
Z  
SumiBoron / SumiDia Inserts

60° Triangle Type 11° Relief  
Without Insert Hole

Uncoated

Dimensions (mm)				
TP_	L	IC	S	D <sub>1</sub>
1103--	11,0	6,35	3,18	
1603--	16,5	9,525	3,18	









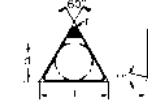

- H** Hardened Steel
- K** Cast Iron
- N** Non-Ferrous Metal
- S** Exotic Alloy
- PM** Sintered Component
- Carbide/Hard Brittle Material

## TPGN

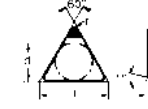

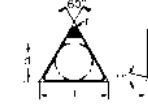

● G-Class SumiBoron (CBN, Regrindable Type)

	RE	CBN																									
		BNC2115	BNC2125	BNC2010	BNC2020	BNC100	BNC160	BNC200	BNC300	BNC500	BNC8115	BN1000	BN2000	BNX10	BNX20	BNX25	BN300	BN350	BN7000	BN7115	BNS8125	NCB100	DA90	DA150	DA1000	NPD10	
	0,4												○														
<b>TPGN 110304</b>	0,4												○														
<b>TPGN 160304</b>	0,8												○		○												
<b>TPGN 160308</b>															○												

● G-Class SumiBoron (CBN, One-Use Type)

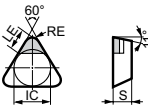
		<b>TPGN 110302 NU</b> <b>TPGN 110304 NU</b> <b>TPGN 110308 NU</b>	0,2 0,4 0,8										○														
		<b>TPGN 160302 NU</b> <b>TPGN 160304 NU</b> <b>TPGN 160308 NU</b>	0,2 0,4 0,8										○		●					○							
		<b>TPGN 110302 LT NU</b> <b>TPGN 110304 LT NU</b> <b>TPGN 110308 LT NU</b>	0,2 0,4 0,8										○														
		<b>TPGN 160304 LT NU</b> <b>TPGN 160308 LT NU</b>	0,4 0,8										○		●					○							
		<b>TPGN 110304 HS NU</b> <b>TPGN 110308 HS NU</b>	0,4 0,8										○														
		<b>TPGN 160304 HS NU</b> <b>TPGN 160308 HS NU</b>	0,4 0,8										○		○												

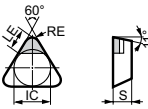
● G-Class SumiDia (PCD, NF Type)

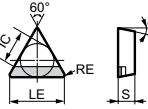
		<b>TPGN 110302 NF</b> <b>TPGN 110304 NF</b> <b>TPGN 110308 NF</b>	0,2 0,4 0,8																								○
		<b>TPGN 160302 NF</b> <b>TPGN 160304 NF</b> <b>TPGN 160308 NF</b>	0,2 0,4 0,8																								●
		<b>TPGN 110304 P NF</b> <b>TPGN 160304 P NF</b>	0,4 0,4																							○	
																										○	

● = Euro stock  
○ = Stock item in Japan

 L8, L9 Edge Specification of SUMIBORON Inserts

C  
D  
R  
S  
T  
V  
W  
Z  
SumiBoron / SumiDia  
Inserts

# SUMIBORON / SUMIDIA Indexable Inserts

TP-- Type 11° pos. Inserts

60° Triangle Type 11° Relief With Insert Hole

Coated

TPGT / TPGW

Dimensions (mm)

TP--	L	IC	S	D <sub>1</sub>
0802--	8,2	4,76	2,39	2,3
0902--	9,62	5,56	2,38	2,5
1102--	11,0	6,35	2,38	2,8
1103--			3,18	3,4
1604--	16,5	9,525	4,76	4,3

**H** Hardened Steel  
**K** Cast Iron  
**N** Non-Ferrous Metal  
**S** Exotic Alloy  
**PM** Sintered Component  
**■** Carbide/Hard Brittle Material

● G-Class SumiBoron (CBN, One-Use Multi-Corner Type)

Shape	ISO Cat. No.	RE	CBN																									
			BNC2115	BNC2125	BNC2010	BNC2020	BNC100	BNC160	BNC200	BNC300	BNC500	BNC8115	BN1000	BN2000	BNX10	BNX20	BNX25	BN300	BN350	BN7000	BN7115	BNS8125	NCB100	DA90	DA150	DA1000	NPD10	
<b>Break Master - FV</b>  CBN with chipbreaker with 3 CBN cutting edges	TPGT 110304 N-FV NC3	0,4	●	●	○	●																						
	TPGT 110308 N-FV NC3	0,8	○	○	○	●	●	○																				

● G-Class SumiBoron (CBN, One-Use Type)

 Standard - Normal cut geometry	TPGW 080202 NC	0,2		●	●	●	●																					
	TPGW 080204 NC	0,4		●	●	●	●																					
	TPGW 110304 NC	0,4		●	●	●	●																					
	TPGW 110308 NC	0,8		●	●	●	●																					

● G-Class SumiBoron (CBN, One-Use Multi-Corner Type)

 Standard Type with 3 CBN cutting edges	TPGW 080202 NC3	0,2	○	○	●	●																							
	TPGW 080204 NC3	0,4	○	○	●	●																							
	TPGW 090202 NC3	0,2	○	○	○	○																							
	TPGW 090204 NC3	0,4	○	○	○	○																							
	TPGW 110302 NC3	0,2	○	○																									
 LE - Type Low cutting force with 3 CBN cutting edges	TPGW 110304 NC3	0,4	○	○						○	○																		
	TPGW 110308 NC3	0,8	○	○						○	○																		
	TPGW 160404 NC3	0,4	○	○							○	○																	
 LE - Type Low cutting force	TPGW 160408 NC3	0,8	○	○							○	○																	
	TPGW 110302 LE-NC3	0,2			○																								
 LE - Type Low cutting force	TPGW 110304 LE-NC3	0,4			○																								
	TPGW 110308 LE-NC3	0,8			○																								
	TPGW 110302 LT-NC3	0,2				○																							
 LT - Type Sharp cutting edge with 3 CBN cutting edges	TPGW 110304 LT-NC3	0,4				○																							
	TPGW 110308 LT-NC3	0,8				○																							
	TPGW 110302 LS-NC3	0,2	○	○																									
 LS - Type Low cutting force with 3 CBN cutting edges	TPGW 110304 LS-NC3	0,4	○	○																									
	TPGW 110308 LS-NC3	0,8	○	○						○	○																		
	TPGW 160404 HS-NC3	0,4		○																									
 HS - Type Sharp cutting edge with 3 CBN cutting edges	TPGW 160408 HS-NC3	0,8		○																									

● = Euro stock  
 ○ = Stock item in Japan

L8, L9 Edge Specification of SUMIBORON Inserts

60° Triangle Type 11° Relief With Insert Hole

Uncoated

## TPGT / TPGW

Dimensions (mm)

TP_	L	IC	S	D <sub>1</sub>
0802--	8,2	4,76	2,39	2,3
0902--	9,62	5,56	2,38	2,5
1102--	11,0	6,35	2,38	2,8
1103--			3,18	3,4
1604--	16,5	9,525	4,76	4,3

- H** Hardened Steel
- K** Cast Iron
- N** Non-Ferrous Metal
- S** Exotic Alloy
- PM** Sintered Component
- Carbide/Hard Brittle Material

● G-Class SumiBoron (CBN, One-Use Multi-Corner Type)

Shape	ISO Cat. No.	RE	Material																								
			Coated							Uncoated																	
			CBN																								
			BNC2115	BNC2125	BNC2010	BNC2020	BNC100	BNC160	BNC200	BNC300	BNC500	BNC8115	BN1000	BN2000	BNX10	BNX20	BNX25	BN300	BN350	BN7000	BN7115	BNS8125	NCB100	DA90	DA150	DA1000	NPD10
 Break Master - FV CBN with chipbreaker with 3 CBN cutting edges	<b>TPGT 110304 N-FV NU3</b>	0,4												●													

● G-Class SumiBoron (CBN, Regrindable Type)

Shape	ISO Cat. No.	RE	Material																								
			Coated							Uncoated																	
			CBN																								
			BNC2115	BNC2125	BNC2010	BNC2020	BNC100	BNC160	BNC200	BNC300	BNC500	BNC8115	BN1000	BN2000	BNX10	BNX20	BNX25	BN300	BN350	BN7000	BN7115	BNS8125	NCB100	DA90	DA150	DA1000	NPD10
 TPGW 110304 TPGW 110308	<b>TPGW 110304</b> <b>TPGW 110308</b>	0,4 0,8													●												

● G-Class SumiBoron (CBN, One-Use Type)

Shape	ISO Cat. No.	RE	Material																								
			Coated							Uncoated																	
			CBN																								
			BNC2115	BNC2125	BNC2010	BNC2020	BNC100	BNC160	BNC200	BNC300	BNC500	BNC8115	BN1000	BN2000	BNX10	BNX20	BNX25	BN300	BN350	BN7000	BN7115	BNS8125	NCB100	DA90	DA150	DA1000	NPD10
 TPGW 080202 NU TPGW 080204 NU TPGW 090204 NU TPGW 110202 NU TPGW 110204 NU TPGW 110302 NU TPGW 110304 NU TPGW 110308 NU TPGW 160404 NU	<b>TPGW 080202 NU</b> <b>TPGW 080204 NU</b>	0,2 0,4												○	●	●											
	<b>TPGW 090204 NU</b>	0,4													○												
	<b>TPGW 110202 NU</b> <b>TPGW 110204 NU</b>	0,2 0,4													○	▲						○					
	<b>TPGW 110302 NU</b> <b>TPGW 110304 NU</b> <b>TPGW 110308 NU</b>	0,2 0,4 0,8													●	▲	●	▲	▲	●	○						
	<b>TPGW 160404 NU</b>	0,4														○							●				
	 TPGW 110308 LF NU	<b>TPGW 110308 LF NU</b>	0,8																			○					
 TPGW 080202 LT NU TPGW 080204 LT NU TPGW 090202 LT NU TPGW 090204 LT NU TPGW 110202 LT NU TPGW 110204 LT NU TPGW 110302 LT NU TPGW 110304 LT NU TPGW 110308 LT NU		<b>TPGW 080202 LT NU</b> <b>TPGW 080204 LT NU</b>	0,2 0,4												○												
		<b>TPGW 090202 LT NU</b> <b>TPGW 090204 LT NU</b>	0,2 0,4													○											
		<b>TPGW 110202 LT NU</b> <b>TPGW 110204 LT NU</b>	0,2 0,4													○											
		<b>TPGW 110302 LT NU</b> <b>TPGW 110304 LT NU</b> <b>TPGW 110308 LT NU</b>	0,2 0,4 0,8													○	○	○	○	○	○	○					

● = Euro stock  
○ = Stock item in Japan

▲ = To be replaced by new item

L8, L9 Edge Specification of SUMIBORON Inserts



SumiBoron / Sumidia Inserts

# SUMIBORON / SUMIDIA Indexable Inserts

TP-- Type 11° pos. Inserts

60° Triangle Type 11° Relief  
With Insert Hole

Uncoated

Dimensions (mm)



TP--	L	IC	S	D <sub>1</sub>
0802--	8,2	4,76	2,39	2,3
0902--	9,62	5,56	2,38	2,5
1102--	11,0	6,35	2,38	2,8
1103--			3,18	3,4
1604--	16,5	9,525	4,76	4,3

- H** Hardened Steel
- K** Cast Iron
- N** Non-Ferrous Metal
- S** Exotic Alloy
- PM** Sintered Component
- Carbide/Hard Brittle Material



## TPGT / TPGW

Shape	ISO Cat. No.	RE	Material																										
			Coated						Uncoated						Uncoated		Uncoated												
			CBN																										
			BNC2115	BNC2125	BNC2010	BNC2020	BNC100	BNC160	BNC200	BNC300	BNC500	BNC8115	BN1000	BN2000	BNX10	BNX20	BNX25	BN300	BN350	BN7000	BN7115	BNS8125	NCB100	DA90	DA150	DA1000	NPD10		
	TPGW 080202 HS NU	0,2																											
	TPGW 080204 HS NU	0,4																											
	TPGW 080208 HS NU	0,8																											
	TPGW 110204 HS NU	0,4																											
	TPGW 110302 HS NU	0,2																											
	TPGW 110304 HS NU	0,4																											
TPGW 110308 HS NU	0,8																												

### ● G-Class SumiBoron (CBN, One-Use Type)

Shape	ISO Cat. No.	RE	BNC2115	BNC2125	BNC2010	BNC2020	BNC100	BNC160	BNC200	BNC300	BNC500	BNC8115	BN1000	BN2000	BNX10	BNX20	BNX25	BN300	BN350	BN7000	BN7115	BNS8125	NCB100	DA90	DA150	DA1000	NPD10		
	TPGW 110204 NU3	0,4																											
	TPGW 110208 NU3	0,8																											
	TPGW 110304 NU3	0,4																											
	TPGW 110308 NU3	0,8																											
		TPGW 110302 LF NU3	0,2																										
		TPGW 110304 LF NU3	0,4																										
TPGW 110308 LF NU3		0,8																											
	TPGW 110304 LE NU3	0,4																											

### ● G-Class SumiBoron (CBN, One-Use Multi-Corner Type)

Shape	ISO Cat. No.	RE	BNC2115	BNC2125	BNC2010	BNC2020	BNC100	BNC160	BNC200	BNC300	BNC500	BNC8115	BN1000	BN2000	BNX10	BNX20	BNX25	BN300	BN350	BN7000	BN7115	BNS8125	NCB100	DA90	DA150	DA1000	NPD10		
	TPGW 110204 NU3	0,4																											
	TPGW 110208 NU3	0,8																											
	TPGW 110304 NU3	0,4																											
	TPGW 110308 NU3	0,8																											
	TPGW 110302 LF NU3	0,2																											
	TPGW 110304 LF NU3	0,4																											
	TPGW 110308 LF NU3	0,8																											
	TPGW 110304 LE NU3	0,4																											

### ● G-Class SumiDia (PCD, NF Type)

Shape	ISO Cat. No.	RE	BNC2115	BNC2125	BNC2010	BNC2020	BNC100	BNC160	BNC200	BNC300	BNC500	BNC8115	BN1000	BN2000	BNX10	BNX20	BNX25	BN300	BN350	BN7000	BN7115	BNS8125	NCB100	DA90	DA150	DA1000	NPD10			
	TPGW 080202 NF	0,2																												
	TPGW 080204 NF	0,4																												
	TPGW 090204 NF	0,4																												
	TPGW 110202 NF	0,2																												
	TPGW 110208 NF	0,8																												
	TPGW 110302 NF	0,2																												
	TPGW 110304 NF	0,4																												
	TPGW 110308 NF	0,8																												
	TPGW 160304 NF	0,4																												
	TPGW 160402 NF	0,2																												
	TPGW 160404 NF	0,4																												
	TPGW 160408 NF	0,8																												

● = Euro stock  
○ = Stock item in Japan

 L8, L9 Edge Specification of SUMIBORON Inserts

60° Triangle Type 11° Relief  
With Insert Hole

Uncoated

Dimensions (mm)

TP--	L	IC	S	D <sub>1</sub>
0802--	8,2	4,76	2,39	2,3
0902--	9,62	5,56	2,38	2,5
1102--	11,0	6,35	2,38	2,8
1103--			3,18	3,4
1604--	16,5	9,525	4,76	4,3

- H Hardened Steel
- K Cast Iron
- N Non-Ferrous Metal
- S Exotic Alloy
- PM Sintered Component
- Carbide/Hard Brittle Material

## TPMT / TPMW

● M-Class SumiDia (PCD, One-Use "Break Master" Type)

Shape	ISO Cat. No.	RE	Material Compatibility																										
			Coated								Uncoated																		
			CBN																										
			BNC2115	BNC2125	BNC2010	BNC2020	BNC100	BNC160	BNC200	BNC300	BNC500	BNC8115	BN1000	BN2000	BNX10	BNX20	BNX25	BN300	BN350	BN7000	BN7115	BNS8125	NCB100	DA90	DA150	DA1000	NPD10		
<b>Break Master - DM</b> 	TPMT 090204 L-DM NU	0,4																											
<b>Break Master - LD</b> 	TPMT 080202 N-LD NF	0,2																											
	TPMT 080204 N-LD NF	0,4																											
	TPMT 090202 N-LD NF	0,2																											
	TPMT 090204 N-LD NF	0,4																											
	TPMT 110202 N-LD NF	0,2																											
	TPMT 110204 N-LD NF	0,4																											
	TPMT 110302 N-LD NF	0,2																											
	TPMT 110304 N-LD NF	0,4																											
	TPMT 110308 N-LD NF	0,8																											
	TPMT 160402 N-LD NF	0,2																											
TPMT 160404 N-LD NF	0,4																												
TPMT 160408 N-LD NF	0,8																												
<b>Break Master - GD</b> 	TPMT 080202 N-GD NF	0,2																											
	TPMT 080204 N-GD NF	0,4																											
	TPMT 090202 N-GD NF	0,2																											
	TPMT 090204 N-GD NF	0,4																											
	TPMT 110202 N-GD NF	0,2																											
	TPMT 110204 N-GD NF	0,4																											
	TPMT 110302 N-GD NF	0,2																											
	TPMT 110304 N-GD NF	0,4																											
	TPMT 110308 N-GD NF	0,8																											
	TPMT 160402 N-GD NF	0,2																											
TPMT 160404 N-GD NF	0,4																												
TPMT 160408 N-GD NF	0,8																												

● M-Class SumiDia (PCD, NF Type)

Shape	ISO Cat. No.	RE	BNC2115	BNC2125	BNC2010	BNC2020	BNC100	BNC160	BNC200	BNC300	BNC500	BNC8115	BN1000	BN2000	BNX10	BNX20	BNX25	BN300	BN350	BN7000	BN7115	BNS8125	NCB100	DA90	DA150	DA1000	NPD10	
	TPMW 080202 NF	0,2																										
	TPMW 080204 NF	0,4																										
	TPMW 110302 NF	0,2																										
	TPMW 110304 NF	0,4																										
	TPMW 110308 NF	0,8																										
	TPMW 160402 NF	0,2																										
	TPMW 160404 NF	0,4																										
	TPMW 160408 NF	0,8																										

● M-Class SumiDia (PCD, Binderless)

Shape	ISO Cat. No.	RE	BNC2115	BNC2125	BNC2010	BNC2020	BNC100	BNC160	BNC200	BNC300	BNC500	BNC8115	BN1000	BN2000	BNX10	BNX20	BNX25	BN300	BN350	BN7000	BN7115	BNS8125	NCB100	DA90	DA150	DA1000	NPD10	
	TPMW 080202 RH	0,2																										
	TPMW 080204 RH	0,4																										
	TPMW 110302 RH	0,2																										
	TPMW 110304 RH	0,4																										
	TPMW 110308 RH	0,8																										
	TPMW 160402 RH	0,2																										
	TPMW 160404 RH	0,4																										
	TPMW 160408 RH	0,8																										

● = Euro stock  
 ○ = Stock item in Japan

L8, L9 Edge Specification of SUMIBORON Inserts

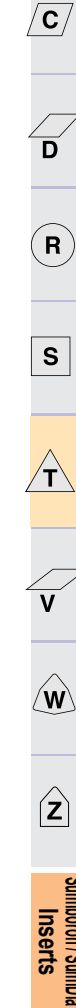



# SUMIBORON / SUMIDIA Indexable Inserts

VB-- Type 5° pos. Inserts

35° Diamond Type 5° Relief  
With Insert Hole



Coated / Uncoated

Dimensions (mm)				
VB--	L	IC	S	D <sub>1</sub>
1102--	11,0	6,35	2,38	2,8
1103--			3,18	
1604--	16,6	9,525	4,76	4,4

**H** Hardened Steel  
**K** Cast Iron  
**N** Non-Ferrous Metal  
**S** Exotic Alloy  
**PM** Sintered Component  
**■** Carbide/Hard Brittle Material

## VBGW

### ● G-Class SumiBoron (CBN, One-Use Type)

Shape	ISO Cat. No.	RE	Material																								
			Coated								Uncoated																
			CBN																								
			BNC2115	BNC2125	BNC2010	BNC2020	BNC100	BNC160	BNC200	BNC300	BNC500	BNC8115	BN1000	BN2000	BNX10	BNX20	BNX25	BN300	BN350	BN7000	BN7115	BNS8125	NCB100	DA90	DA150	DA1000	NPD10
 Standard - Normal cut geometry	VBGW 110202 NC VBGW 110204 NC VBGW 110208 NC	0,2 0,4 0,8	●	●	●	●			●																		
	VBGW 110202 NU VBGW 110204 NU VBGW 110208 NU	0,2 0,4 0,8												●	●	●											
	VBGW 110302 NU VBGW 110304 NU VBGW 110308 NU	0,2 0,4 0,8											○	○	○									○	○		
 LT - Type Sharp cutting edge	VBGW 160402 NU VBGW 160404 NU VBGW 160408 NU	0,2 0,4 0,8										●	●	●	▲			▲	●	●			○	○			
	VBGW 110302 LT NU VBGW 110304 LT NU VBGW 110308 LT NU	0,2 0,4 0,8											○	○	○												
	VBGW 160402 LT NU VBGW 160404 LT NU VBGW 160408 LT NU	0,2 0,4 0,8											○	○	○									○	○		
 HS - Type Strong cutting edge	VBGW 110302 HS NU VBGW 110304 HS NU VBGW 110308 HS NU	0,2 0,4 0,8											○	○	○												
	VBGW 160404 HS NU VBGW 160408 HS NU	0,4 0,8											○	○													

● = Euro stock  
○ = Stock item in Japan

▲ = To be replaced by new item

 L8, L9 Edge Specification of SUMIBORON Inserts

35° Diamond Type 5° Relief  
With Insert Hole









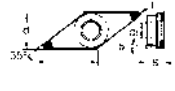

Coated / Uncoated

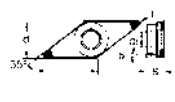
Dimensions (mm)				
VB_	L	IC	S	D <sub>1</sub>
1102--	11,0	6,35	2,38	2,8
1103--			3,18	
1604--	16,6	9,525	4,76	4,4

- H Hardened Steel
- K Cast Iron
- N Non-Ferrous Metal
- S Exotic Alloy
- PM Sintered Component
- Carbide/Hard Brittle Material

## VBGW ○○○○○○

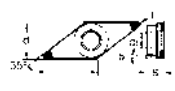
● G-Class SumiBoron (CBN, One-Use Multi-Corner Type)

Shape	ISO Cat. No.	RE	Material																								
			Coated							Uncoated																	
			BNC2115	BNC2125	BNC2010	BNC2020	BNC100	BNC160	BNC200	BNC300	BNC500	BNC8115	BN1000	BN2000	BNX10	BNX20	BNX25	BN300	BN350	BN7000	BN7115	BN8125	NCB100	DA90	DA150	DA1000	NPD10
  with 2 CBN cutting edges	<b>VBGW 110304 NU2</b> <b>VBGW 160404 NU2</b> <b>VBGW 160408 NU2</b>	0,4 0,4 0,8																									
 Standard - Normal cut geometry  with 2 CBN cutting edges	<b>VBGW 110302 NC2</b> <b>VBGW 110304 NC2</b> <b>VBGW 110308 NC2</b>  <b>VBGW 160402 NC2</b> <b>VBGW 160404 NC2</b> <b>VBGW 160408 NC2</b> <b>VBGW 160412 NC2</b>	0,2 0,4 0,8  0,2 0,4 0,8 1,2	○	○	○	○																					
 LE - Type Low cutting force  with 2 CBN cutting edges	<b>VBGW 160408 LE NU2</b>  <b>VBGW 160402 LE-NC2</b> <b>VBGW 160404 LE-NC2</b> <b>VBGW 160408 LE-NC2</b>	0,8  0,2 0,4 0,8																									
 LT - Type Sharp cutting edge  with 2 CBN cutting edges	<b>VBGW 110302 LT-NC2</b> <b>VBGW 110304 LT-NC2</b>  <b>VBGW 160402 LT-NC2</b> <b>VBGW 160404 LT-NC2</b> <b>VBGW 160408 LT-NC2</b>	0,2 0,4  0,2 0,4 0,8			○	●																					
 LS - Type Low cutting force  with 2 CBN cutting edges	<b>VBGW 110302 LS-NC2</b> <b>VBGW 110304 LS-NC2</b> <b>VBGW 110308 LS-NC2</b>  <b>VBGW 160402 LS-NC2</b> <b>VBGW 160404 LS-NC2</b> <b>VBGW 160408 LS-NC2</b>	0,2 0,4 0,8  0,2 0,4 0,8	○	○																							
 HS - Type Strong cutting edge  with 2 CBN cutting edges	<b>VBGW 160404 HS-NC2</b> <b>VBGW 160408 HS-NC2</b>	0,4 0,8		●		●				●	●																

● = Euro stock  
 ○ = Stock item in Japan

▲ = To be replaced by new item

 L8, L9 Edge Specification of SUMIBORON Inserts

- C
- D
- R
- S
- T
- V
- W
- Z

Sumiboron / Sumidia Inserts

# SUMIBORON / SUMIDIA Indexable Inserts

VC-- Type 7° pos. Inserts

35° Diamond Type 7° Relief  
With Insert Hole



Coated / Uncoated

Dimensions (mm)				
VC--	L	IC	S	D <sub>1</sub>
0802--	8,3	4,76	2,38	2,3
1103--	11,0	6,35	3,18	2,8
1604--	16,6	9,525	4,76	4,4



**H** Hardened Steel  
**K** Cast Iron  
**N** Non-Ferrous Metal  
**S** Exotic Alloy  
**PM** Sintered Component  
**■** Carbide/Hard Brittle Material

## VCGW

### ● G-Class SumiBoron (CBN, One-Use Type)

Shape	ISO Cat. No.	RE	Material																								
			Coated					Uncoated					Uncoated														
			CBN																								
			BNC2115	BNC2125	BNC2010	BNC2020	BNC100	BNC160	BNC200	BNC300	BNC500	BNC8115	BN1000	BN2000	BNX10	BNX20	BNX25	BN300	BN350	BN7000	BN7115	BNS8125	NCB100	DA90	DA150	DA1000	NPD10
 	VCGW 080202 NU VCGW 080204 NU	0,2 0,4																									
	VCGW 110301 NU VCGW 110302 NU VCGW 110304 NU	0,1 0,2 0,4																									
	VCGW 160404 NU VCGW 160408 NU	0,4 0,8																									
	VCGW 080202 LT NU VCGW 080204 LT NU VCGW 080208 LT NU	0,2 0,4 0,8																									

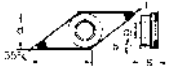
### ● G-Class SumiBoron (CBN, One-Use Multi-Corner Type)

Shape	ISO Cat. No.	RE	Material																								
			Coated					Uncoated					Uncoated														
			CBN																								
			BNC2115	BNC2125	BNC2010	BNC2020	BNC100	BNC160	BNC200	BNC300	BNC500	BNC8115	BN1000	BN2000	BNX10	BNX20	BNX25	BN300	BN350	BN7000	BN7115	BNS8125	NCB100	DA90	DA150	DA1000	NPD10
  <p>Standard - Normal cut geometry with 2 CBN cutting edges</p>	VCGW 080202 NC2 VCGW 080204 NC2	0,2 0,4																									
	VCGW 160404 NC2 VCGW 160408 NC2	0,4 0,8																									
  <p>LS - Type Low cutting force with 2 CBN cutting edges</p>	VCGW 160404 LS NC2 VCGW 160408 LS NC2	0,4 0,8																									
	VCGW 160404 HS NC2 VCGW 160408 HS NC2	0,4 0,8																									

● = Euro stock  
 ○ = Stock item in Japan

 L8, L9 Edge Specification of SUMIBORON Inserts

C  
D  
R  
S  
T  
V  
W  
Z  
SumiBoron / SumiDia Inserts

35° Diamond Type 7° Relief  
With Insert Hole



Uncoated

Dimensions (mm)				
VC--	L	IC	S	D <sub>1</sub>
0802--	8,3	4,76	2,38	2,3
1103--	11,0	6,35	3,18	2,8
1604--	16,6	9,525	4,76	4,4
2205--		12,7	5,56	5,5



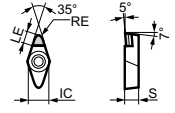

- H Hardened Steel
- K Cast Iron
- N Non-Ferrous Metal
- S Exotic Alloy
- PM Sintered Component
- Carbide/Hard Brittle Material

## VCMT / VCGW

● M-Class (Regrindable Type)

Shape	ISO Cat. No.	RE	Material																									
			Coated							Uncoated																		
			CBN																									
			BNC2115	BNC2125	BNC2010	BNC2020	BNC100	BNC160	BNC200	BNC300	BNC500	BNC8115	BN1000	BN2000	BNX10	BNX20	BNX25	BN300	BN350	BN7000	BN7115	BNS8125	NCB100	DA90	DA150	DA1000	NPD10	
		<b>VCMT 220530</b>	3,0																									
		<b>VCMW 160404</b>	0,4																									

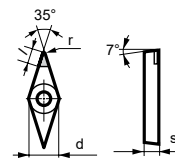
● M-Class SumiDia (PCD, NF Type)

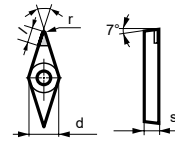
		<b>VCMT 110301 NF</b> <b>VCMT 110302 NF</b> <b>VCMT 110304 NF</b>	0,1 0,2 0,4																										
		<b>VCMT 160404 NF</b> <b>VCMT 160408 NF</b> <b>VCMT 160412 NF</b>	0,4 0,8 1,2																										
		<b>VCMT 110302 N-LD NF</b> <b>VCMT 110304 N-LD NF</b>	0,2 0,4																										
		<b>VCMT 160404 N-LD NF</b> <b>VCMT 160408 N-LD NF</b> <b>VCMT 160412 N-LD NF</b>	0,4 0,8 1,2																										
		<b>VCMT 110302 N-GD NF</b> <b>VCMT 110304 N-GD NF</b>	0,2 0,4																										
		<b>VCMT 160404 N-GD NF</b> <b>VCMT 160408 N-GD NF</b> <b>VCMT 160412 N-GD NF</b>	0,4 0,8 1,2																										

● M-Class SumiDia (PCD, NF Type)

		<b>VCMW 080202 NF</b> <b>VCMW 080204 NF</b> <b>VCMW 110302 NF</b> <b>VCMW 110304 NF</b> <b>VCMW 160402 NF</b> <b>VCMW 160404 NF</b> <b>VCMW 160408 NF</b> <b>VCMW 160412 NF</b>	0,2 0,4 0,2 0,4 0,2 0,4 0,8 1,2																										
---	--	--	--	--	--	--	--	--	--	--	--	--	--	--	--	--	--	--	--	--	--	--	--	--	--	--	--	--	--

● M-Class SumiDia (PCD, Binderless)

		<b>VCMW 080201 RH</b> <b>VCMW 080202 RH</b> <b>VCMW 080204 RH</b> <b>VCMW 110302 RH</b> <b>VCMW 110304 RH</b> <b>VCMW 160402 RH</b> <b>VCMW 160404 RH</b> <b>VCMW 160408 RH</b> <b>VCMW 160412 RH</b>	0,1 0,2 0,4 0,2 0,4 0,2 0,4 0,8 1,2																										
---	--	---	---	--	--	--	--	--	--	--	--	--	--	--	--	--	--	--	--	--	--	--	--	--	--	--	--	--	--

● = Euro stock  
 ○ = Stock item in Japan

 L8, L9 Edge Specification of SUMIBORON Inserts

- C
- D
- R
- S
- T
- V
- W
- Z

SumiDia / SumiDia Inserts

# SUMIBORON / SUMIDIA Indexable Inserts

## VN\_A neg. Type Inserts

35° Diamond Type 0° Relief  
With Insert Hole



Uncoated

Dimensions (mm)				
VN..	L	IC	S	D <sub>1</sub>
1604--	16,6	9,525	4,76	3,81

- H** Hardened Steel
- K** Cast Iron
- N** Non-Ferrous Metal
- S** Exotic Alloy
- PM** Sintered Component
- Carbide/Hard Brittle Material

# VNGA

### ● G-Class SumiBoron (CBN, One-Use Multi-Corner Type)

Shape	ISO Cat. No.	RE	CBN																								
			BNC2115	BNC2125	BNC2010	BNC2020	BNC100	BNC160	BNC200	BNC300	BNC500	BNC8115	BN1000	BN2000	BNX10	BNX20	BNX25	BN300	BN350	BN7000	BN7115	BNS8125	NCB100	DA90	DA150	DA1000	NPD10
 with 2 CBN cutting edges	<b>VNGA 160404 NU2</b> <b>VNGA 160408 NU2</b>	0,4										●	●		●				○			○					
		0,8											●	●		●					○			○			
 with 2 CBN cutting edges	<b>VNGA 160404 LT NU2</b> <b>VNGA 160408 LT NU2</b>	0,4																									
		0,8													○	○											
 with 2 CBN cutting edges	<b>VNGA 160404 HS NU2</b> <b>VNGA 160408 HS NU2</b>	0,4																									
		0,8													○	○											

### ● G-Class SumiBoron (CBN, One-Use Type)

	<b>VNGA 160404 NU</b> <b>VNGA 160408 NU</b>	0,4																										
		0,8																										○

● = Euro stock  
○ = Stock item in Japan

 L8, L9 Edge Specification of SUMIBORON Inserts

35° Diamond Type 0° Relief  
With Insert Hole













Coated

Dimensions (mm)				
VN_	L	IC	S	D <sub>1</sub>
1604--	16,6	9,525	4,76	3,81

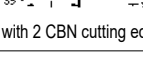
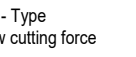
- H** Hardened Steel
- K** Cast Iron
- N** Non-Ferrous Metal
- S** Exotic Alloy
- PM** Sintered Component
- Carbide/Hard Brittle Material

## VNGA / VNGG

● G-Class SumiBoron (CBN, One-Use Multi-Corner Type)

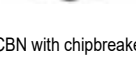
Shape	ISO Cat. No.	RE	Material																								
			Coated								Uncoated																
			CBN																								
			BNC2115	BNC2125	BNC2010	BNC2020	BNC100	BNC160	BNC200	BNC300	BNC500	BNC8115	BN1000	BN2000	BNX10	BNX20	BNX25	BN300	BN350	BN7000	BN7115	BNS8125	NCB100	DA90	DA150	DA1000	NPD10
 with 2 CBN cutting edges	VNGA 160404 NC2	0,4	●	○	○	○	○	○	○	○	○	○	○	○	○	○	○	○	○	○	○	○	○	○	○	○	○
	VNGA 160408 NC2	0,8	○	○	○	○	○	○	○	○	○	○	○	○	○	○	○	○	○	○	○	○	○	○	○	○	○
 with 4 CBN cutting edges	VNGA 160402 NC4	0,2	○	○	○	○	○	○	○	○	○	○	○	○	○	○	○	○	○	○	○	○	○	○	○	○	○
	VNGA 160404 NC4	0,4	○	○	○	○	○	○	○	○	○	○	○	○	○	○	○	○	○	○	○	○	○	○	○	○	○
 with 4 CBN cutting edges	VNGA 160408 NC4	0,8	○	○	○	○	○	○	○	○	○	○	○	○	○	○	○	○	○	○	○	○	○	○	○	○	○
	VNGA 160412 NC4	1,2	○	○	○	○	○	○	○	○	○	○	○	○	○	○	○	○	○	○	○	○	○	○	○	○	○
 LT - Type Sharp cutting edge	VNGA 160402 LT-NC2	0,2				○																					
	VNGA 160404 LT-NC2	0,4				○																					
 with 2 CBN cutting edges	VNGA 160408 LT-NC2	0,8				○																					
	VNGA 160412 LT-NC2	1,2				○																					
 LS - Type Low cutting force	VNGA 160402 LS-NC2	0,2		○																							
	VNGA 160404 LS-NC2	0,4		○																							
 with 2 CBN cutting edges	VNGA 160408 LS-NC2	0,8		○																							
	VNGA 160412 LS-NC2	1,2		○																							
 with 4 CBN cutting edges	VNGA 160404 LS-NC4	0,4					○																				
	VNGA 160408 LS-NC4	0,8					○																				
 with 4 CBN cutting edges	VNGA 160412 LS-NC4	1,2					○																				
 HS - Type Strong cutting edge	VNGA 160404 HS-NC4	0,4	○	○																							
	VNGA 160408 HS-NC4	0,8	○	○																							
 with 4 CBN cutting edges	VNGA 160412 HS-NC4	1,2	○	○		○				○	○																
 ES - Type Crater wear stability	VNGA 160404 ES-NC4	0,4					●																				
	VNGA 160408 ES-NC4	0,8					●																				
 with 4 CBN cutting edges	VNGA 160412 ES-NC4	1,2					○																				
 Break Master - FV, - LV	VNGG 160404 N-FV NC4	0,4	●	○	●		●	●																			
	VNGG 160408 N-FV NC4	0,8	●	○	●		●	●																			
 CBN with chipbreaker	VNGG 160404 N-LV NC4	0,4	●	●	●		○	●																			
	VNGG 160408 N-LV NC4	0,8	●	●	●		○	●																			

● = Euro stock  
○ = Stock item in Japan

Edge Specification of SUMIBORON Inserts



SumiBoron Sumidia Inserts



# SUMIBORON / SUMIDIA Indexable Inserts

VN\_A neg. Type and VNMX Special Inserts

35° Diamond Type 0° Relief With Insert Hole

Uncoated

Dimensions (mm)				
VN--	L	IC	S	D <sub>1</sub>
1604--	16,6	9,525	4,76	3,81

- H** Hardened Steel
- K** Cast Iron
- N** Non-Ferrous Metal
- S** Exotic Alloy
- PM** Sintered Component
- Carbide/Hard Brittle Material

## VNGM / VNMA

### ● G-Class SumiBoron (CBN, One-Use Multi-Corner Type)

Shape	ISO Cat. No.	RE	Material																									
			BNC2115	BNC2125	BNC2010	BNC2020	BNC100	BNC160	BNC200	BNC300	BNC500	BNC8115	BN1000	BN2000	BNX10	BNX20	BNX25	BN300	BN350	BN7000	BN7115	BNS8125	NCB100	DA90	DA150	DA1000	NPD10	
 Break Master - LV CBN with chipbreaker with 2 CBN cutting edges	VNGM 160404 N-LV NU2	0,4																										
	VNGM 160408 N-LV NU2	0,8											●	●														

### ● M-Class SumiBoron (CBN, Regrindable Type)

 VNMA 160404 VNMA 160408	0,4																											
	0,8												○	○	▲													

### ● M-Class SumiBoron (CBN, One-Use Type)

 VNMA 160401 NU VNMA 160402 NU VNMA 160404 NU VNMA 160408 NU VNMA 160412 NU VNMA 160408 NS	0,1												○	○														
	0,2												○	○														
	0,4												●	●	▲													
	0,8												●	●	▲													
	1,2												○	○	▲													
	0,8																											

### ● M-Class SumiDia (PCD, NF Type)

 VNMA 160408 NF VNMA 160412 NF	0,8																											
	1,2																							○	○			

### ● M-Class SumiDia (PCD, Binderless)

 VNMA 160408 RH VNMA 160412 RH	0,8																											
	1,2																											○

## VNMX

### ● M-Class SumiDia (PCD, Regrindable Type)

Shape	ISO Cat. No.	RE	Material																									
			BNC2010	BNC2020	BNC100	BNC160	BNC200	BNC300	BNC500	BN1000	BN2000	BNX10	BNX20	BNX25	BN250	BN300	BN350	BN700	BN7000	BN7500	BNS800	NCB100	DA90	DA150	DA1000	NPD10		
 VNMX 160402 NF VNMX 160404 NF VNMX 160408 NF VNMX 160412	0,2																											
	0,4																											
	0,8																											
	1,2																											

● = Euro stock  
○ = Stock item in Japan

▲ = To be replaced by new item

 L8, L9 Edge Specification of SUMIBORON Inserts

C  
D  
R  
S  
T  
V  
W  
Z

SumiBoron / SumiDia Inserts

80° Trigon Type      0° Relief  
With Insert Hole

Coated / Uncoated

Dimensions (mm)				
WN_	L	IC	S	D <sub>1</sub>
0804--	8,69	12,7	4,76	5,16

**H** Hardened Steel  
**K** Cast Iron  
**N** Non-Ferrous Metal  
**S** Exotic Alloy  
**PM** Sintered Component  
■ Carbide/Hard Brittle Material

## WNGA

● M-Class SumiBoron (CBN, One-Use Type)

Shape	ISO Cat. No.	RE	Material Compatibility																								
			Coated						Uncoated																		
			CBN																								
			BNC2115	BNC2125	BNC2010	BNC2020	BNC100	BNC160	BNC200	BNC300	BNC500	BNC8115	BN1000	BN2000	BNX10	BNX20	BNX25	BN300	BN350	BN7000	BN7115	BNS8125	NCB100	DA90	DA150	DA1000	NPD10
	<b>WNMA 080408 NU</b>	0,8												○													

● G-Class SumiBoron (CBN, One-Use Multi-Corner Type)

Shape	Diagram	ISO Cat. No.	RE	Material Compatibility																							
				Coated						Uncoated																	
			CBN																								
			BNC2115	BNC2125	BNC2010	BNC2020	BNC100	BNC160	BNC200	BNC300	BNC500	BNC8115	BN1000	BN2000	BNX10	BNX20	BNX25	BN300	BN350	BN7000	BN7115	BNS8125	NCB100	DA90	DA150	DA1000	NPD10
	 with 6 CBN cutting edges	<b>WNGA 080404 NC6</b> <b>WNGA 080408 NC6</b> <b>WNGA 080412 NC6</b>	0,4 0,8 1,2	●	●	○	●			●																	
	 with 3 CBN cutting edges	<b>WNGA 080408 LT-NC3</b>	0,8			○																					
	 with 3 CBN cutting edges	<b>WNGA 080408 LS NC3</b>	0,8	○	○																						
	 with 6 CBN cutting edges	<b>WNGA 080408 LS NC6</b>	0,8						○																		
	 with 6 CBN cutting edges	<b>WNGA 080408 HS NC6</b>	0,8	○	○				○																		
	 (Wiper Type)	<b>WNGA 080408 NC-WG6</b>	0,8	○	○	●	●		○	○																	
		<b>WNGA 080408 NC-WH6</b>	0,8	○	○	●	●		○	○																	

● = Euro stock  
○ = Stock item in Japan

L8, L9 Edge Specification of SUMIBORON Inserts

C  
D  
R  
S  
T  
V  
W  
Z

Sumiboron Sumidia  
Inserts

# SUMIBORON / SUMIDIA Indexable Inserts

## ZN-- Special Inserts

80° Special Type 7° Relief  
With Insert Hole

Coated / Uncoated

Dimensions (mm)				
WNL-	L	IC	S	D <sub>1</sub>
0401--	-	4,76	1,69	2,3

- H** Hardened Steel
- K** Cast Iron
- N** Non-Ferrous Metal
- S** Exotic Alloy
- PM** Sintered Component
- Carbide/Hard Brittle Material

# ZNEX

### ● SumiBoron (CBN, One-Use Type)

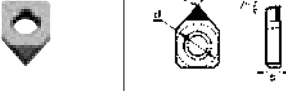
Shape	ISO Cat. No.	RE	CBN																										
			Coated								Uncoated																		
			BNC2115	BNC2125	BNC2010	BNC2020	BNC100	BNC160	BNC200	BNC300	BNC500	BNC8115	BN1000	BN2000	BNX10	BNX20	BNX25	BN300	BN350	BN7000	BN7115	BNS8125	NCB100	DA90	DA150	DA1000	NPD10		
	ZNEX 040102 NC ZNEX 040104 NC	0,2 0,4				●	●	●	●																				
	ZNEX 040102 LE-NC ZNEX 040104 LE-NC	0,2 0,4			○																								
	ZNEX 040102 LT-NC ZNEX 040104 LT-NC	0,2 0,4			○																								
	ZNEX 040102 NU ZNEX 040104 NU	0,2 0,4											●	●	▲	●						○							

● = Euro stock  
○ = Stock item in Japan







▲ = To be replaced by new item

 L8, L9 Edge Specification of SUMIBORON Inserts

## SUMIDIA Binderless PCD - Insert Grade NPD10

### Negative Inserts





Application: Hard brittle material

	Shape	ISO Cat. No.	Dimensions (mm)					NPD10
			Inscribed Circle (IC)	Thick-ness	Hole Size	Nose Radius	Cutting Edge Length	
 55° Diamond Type		<b>DNMA 150408 RH</b> <b>150412 RH</b>	12,70	4,76	5,16	0,8	1,8	○
						1,2	1,8	○
 Square Type		<b>SNMA 120408 RH</b> <b>120412 RH</b>	12,70	4,76	5,16	0,8	1,7	○
						1,2	1,7	○
 35° Diamond Type		<b>VNMA 160408 RH</b> <b>160412 RH</b>	9,525	4,76	3,81	0,8	1,8	○
						1,2	1,5	○

Note: Clearance angle of cutting edge tip can show deviation due to the production process.

### Positive Inserts

Application: Hard brittle material

	Rake Angle	Shape	ISO Cat. No.	Dimensions (mm)					NPD10			
				Inscribed Circle (IC)	Thick-ness	Hole Size	Nose Radius	Cutting Edge Length				
 80° Diamond Type	7°		<b>CCMW 03X102 RH</b> <b>03X104 RH</b>	3,50	1,40	1,9	0,2	1,3	○			
			<b>CCMW 04X102 RH</b> <b>04X104 RH</b>				4,30	1,80	2,3	0,2	1,7	○
			<b>CCMW 060202 RH</b> <b>060204 RH</b>	6,35	2,38	2,8	0,2	1,7	○			
			<b>CCMW 09T302 RH</b> <b>09T304 RH</b> <b>09T308 RH</b>				9,525	3,97	4,4	0,2	1,7	○
			7°		<b>DCMW 070202 RH</b> <b>070204 RH</b>	6,35	2,38	2,8	0,2	2,1	○	
					<b>DCMW 11T302 RH</b> <b>11T304 RH</b> <b>11T308 RH</b>				9,525	3,97	4,4	0,2
	7°				<b>DCMW 11T302 RH</b> <b>11T304 RH</b> <b>11T308 RH</b>	9,525	3,97	4,4	0,2	2,1	○	
					<b>DCMW 11T302 RH</b> <b>11T304 RH</b> <b>11T308 RH</b>				9,525	3,97	4,4	0,2
 Triangular Type	11°		<b>TPMW 080202 RH</b> <b>080204 RH</b>	4,76	2,38	2,3	0,2	1,2	○			
			<b>TPMW 110302 RH</b> <b>110304 RH</b> <b>110308 RH</b>				6,35	3,18	3,4	0,2	1,5	○
			<b>TPMW 160402 RH</b> <b>160404 RH</b> <b>160408 RH</b>							9,525	4,76	4,4
		<b>TPMW 160402 RH</b> <b>160404 RH</b> <b>160408 RH</b>	9,525	4,76	4,4	0,2						
		<b>TPMW 160402 RH</b> <b>160404 RH</b> <b>160408 RH</b>				9,525	4,76	4,4	0,4			
		<b>TPMW 160402 RH</b> <b>160404 RH</b> <b>160408 RH</b>							9,525	4,76	4,4	0,8
 35° Diamond Type	7°		<b>VCMW 080201 RH</b> <b>080202 RH</b> <b>080204 RH</b>	4,76	2,38							2,3
			<b>VCMW 110302 RH</b> <b>110304 RH</b>			6,35	3,18	2,8				
			<b>VCMW 110302 RH</b> <b>110304 RH</b>						6,35	3,18	2,8	
		<b>VCMW 160402 RH</b> <b>160404 RH</b> <b>160408 RH</b> <b>160412 RH</b>	9,525	4,76	4,4							0,2
		<b>VCMW 160402 RH</b> <b>160404 RH</b> <b>160408 RH</b> <b>160412 RH</b>				9,525	4,76	4,4				0,2
		<b>VCMW 160402 RH</b> <b>160404 RH</b> <b>160408 RH</b> <b>160412 RH</b>							9,525	4,76	4,4	0,4
<b>VCMW 160402 RH</b> <b>160404 RH</b> <b>160408 RH</b> <b>160412 RH</b>	9,525	4,76	4,4	0,4	1,7							○
<b>VCMW 160402 RH</b> <b>160404 RH</b> <b>160408 RH</b> <b>160412 RH</b>				9,525	4,76	4,4	0,8	1,8				○
<b>VCMW 160402 RH</b> <b>160404 RH</b> <b>160408 RH</b> <b>160412 RH</b>							9,525	4,76	4,4	1,2	1,5	○

Note: Clearance angle of cutting edge tip can show deviation due to the production process.

C

D

R

S

T

V

W

Z

Sumidia  
Inserts



**BSME** → M48-50

**Very small boring bar - brazed type**

- Solid carbide shank boring bar with brazed CBN tip and inner coolant supply.
- For tiny hole diameter boring in hardened steel.
- Min. boring dia. is  $\varnothing$  2,5 mm.



**SEXC** → M48-51

**CBN boring tool for small diameter boring**

- Solid carbide shank boring bar with indexable CBN insert and inner coolant supply.
- For small hole diameter boring in hardened steel.
- Min. boring dia. is  $\varnothing$  4,0 mm.



**BNBB** → M52

**Small hole boring tools**

- CBN cutting edge is brazed on to a solid carbide shank.
- Small hole boring for hardened steels.
- Min. boring dia. is  $\varnothing$  3,5 mm.



**BNZ** → M53

**Small hole boring bars**

- Solid carbide boring bars with economical CBN insert.
- Small hole boring for hardened steels.
- Min. boring dia. is  $\varnothing$  7,0 mm.



**BNB** → M53

**Small hole boring bars**

- Solid carbide boring bars with economical CBN and PCD insert.
- Min. boring dia. is  $\varnothing$  10,0 mm.



**GWB / PSC** → M54-55

**CBN Grooving System for Hardened Steels**

- Tangential Inserts – Double clamp holder
- Groove Widths from 1,5 – 6,0mm
- New CBN grade for interrupted grooving
- ISO-PSC polygon modular grooving system



**BNGG** → M56

**Threading holders**

- CBN cutting edge for hardened steel
- Adjustable threading after regrinding.

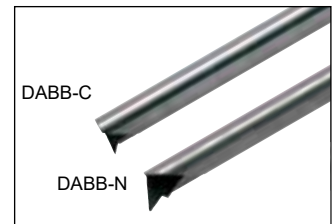

**DABB** → M57

**Small hole boring tools**

- PCD cutting edge for finishing of small non-ferrous parts
- Min. boring dia. is  $\varnothing$  3,0 mm.
- DABB-C for boring  
DABB-N for profiling and corner grooving



**ANX** → M58-69

**High speed cutter for Non-ferrous Metal**

- Achieves feeds of over  $v_f = 30.000$  mm/min
- 6 different edge preparations
- Simple screw-fastening structure enables fine adjustments to be made easily
- Precise applications of coolant to the machining point
- Milling cutter range with diameter from  $\varnothing 32-160$  mm



**RF** → M70

**High speed face mill for Aluminium**

- Finishing and roughing aluminium alloys and non-ferrous materials
- High precision and highspeed machining  $v_c = 5000$  m/min
- Aluminium alloy body  
Run-out less than  $10 \mu\text{m}$
- Easy assembling



**SRF** → M71

**High speed face mill for Aluminium**

- Small diameter cutter for small machines
- High speed roughing and finishing with SumiDia DA2200
- High speed capability of  $\text{rpm} = 20.000$
- Economical PCD insert NF type



**FMU** → M72-73

**"BN Finish Mill" for finishing grey cast iron**

- High speed machining  $v_c = 1500$  m/min
- Excellent surface roughness  $R_z = 3,2$
- Run-out less than  $10 \mu\text{m}$
- Easy assembling



**BNES** → M74

**"Helical Master" SUMIBORON Endmill**

- Spiral CBN brazed cutting edge for super finishing hardened steel (HRC 50 – 60)
- Dry machining
- Stable cutting
- High accuracy
- Excellent swarf evacuation

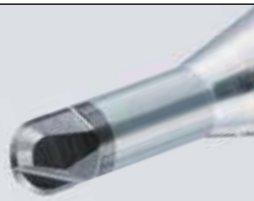

**BNBP** → M75

**"Mould Finish Master" SUMIBORON Micro Ball Nose Endmills**

- High precision machining of hardened steels < HRC 70 with long tool life
- Super tough grade SUMIBORON BN350 prevents chipping of the cutting edge
- R accuracy :  $\pm 0,005$  mm



**NPDRS / NPDB(S)** → M76-77

**"Mould Finish Master" SUMIDIA Binderless Endmills**

- NPDRS - radius endmills
- NPDB(S) - ball nose endmills
- For finishing of carbide and brittle materials
- High precision machining and long tool life



**DAL / DDL / DML** → M78-79

**High precision SUMIDIA Drills**

- PCD cutting edge is brazed on to a solid carbide shank.
- From general to high precision drilling of Aluminium alloys
- DML type is suitable for chamfering and stepped drilling



# BSME/SEXC Series

## ■ Features

- New ultra small boring bar with CBN cutting edge
- Internal coolant
- Easy setting and handling
- High accuracy
- Carbide body for high rigidity
- One sleeve for different diameters

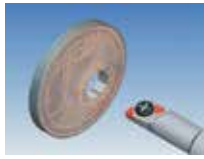

## ■ Basic System

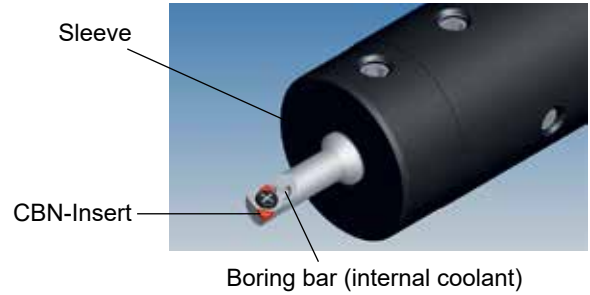

## ■ 2 Types of CBN Small Hole Boring Bar System

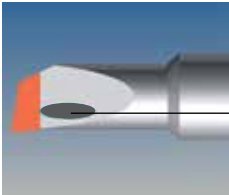
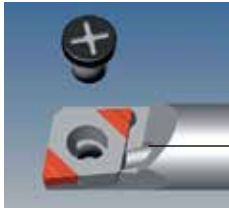
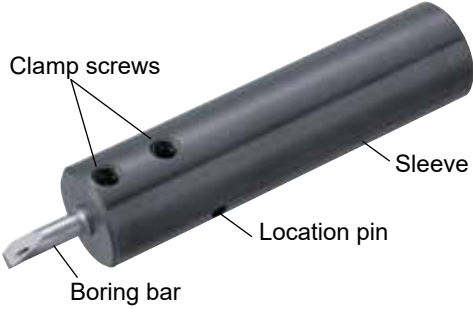
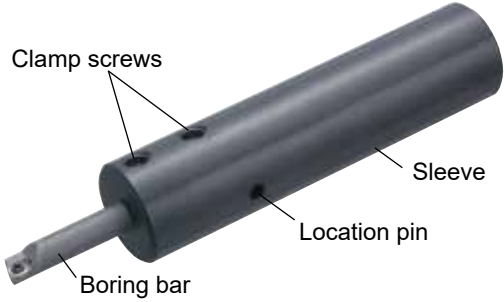
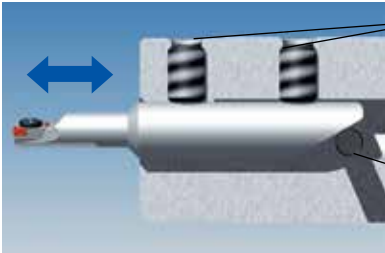
BSME - CBN Brazed Cutting Edge Type	SEXC - Indexable CBN Insert Type
Min. bore diameter: $\varnothing 2,5 - 5,0$ mm	Min. bore diameter: $\varnothing 4,0 - 6,0$ mm
<p>Unique cutting edge shape with high quality and sharpness</p>  <p>Internal coolant hole (standard)</p>	<p>2 corner inserts</p>  <p>Internal coolant hole (standard)</p>
 <p>Clamp screws</p> <p>Sleeve</p> <p>Location pin</p> <p>Boring bar</p>	 <p>Clamp screws</p> <p>Sleeve</p> <p>Location pin</p> <p>Boring bar</p>
<p>Excellent repeatability of boring bar (deviation within 0,020 mm)</p>  <p>Clamp screws</p> <p>Location pin for controlled cutting edge position</p>	

## ■ Application Range

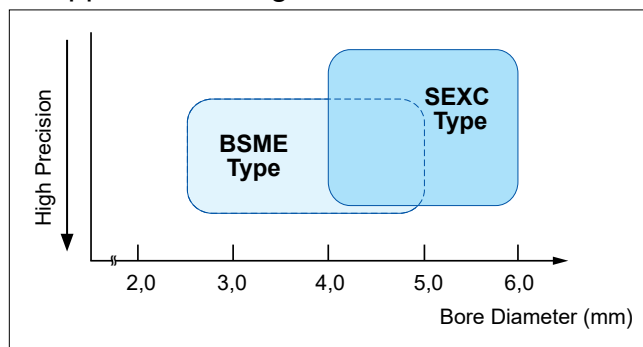



## ■ Recommended Cutting Conditions

Spindle Speed (n)	$>2000 \text{ min}^{-1}$	Low speed may cause chattering and chipping on the cutting edge.
Depth of Cut ( $a_p$ )	0,01 – 0,15 mm	Excessive depth of cut may cause larger tool deflection resulting in deterioration of bore accuracy.
Feed Rate (f)	0,01 – 0,1 mm/rev	-

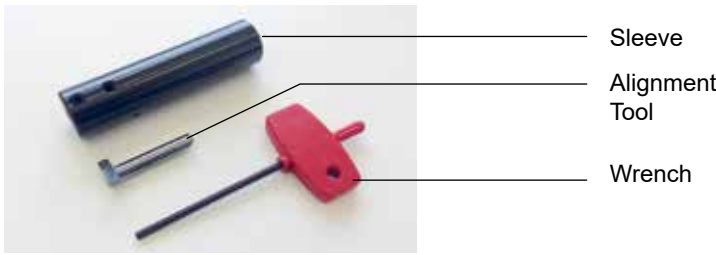
■ Accessories

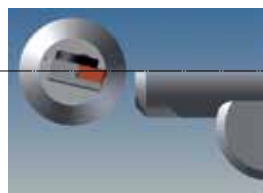

■ Mounting Instruction

<p>1. Insert alignment tool into the sleeve until you connect with the pin inside. Gently lock the screws to hold.</p>	
<p>2. Locate the sleeve into your tool-holding system. Gently lock the screws to hold.</p>	
<p>3. Clock the flat of the alignment tool into a straight position.</p> 	<p>After adjustment, equipped boring bar has automatically cutting peak height of zero on the center of</p> 
<p>4. Use pre setting machine to set the diameter of the boring bar.</p>	

■ Application Example

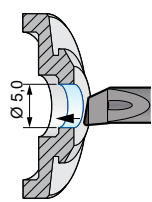
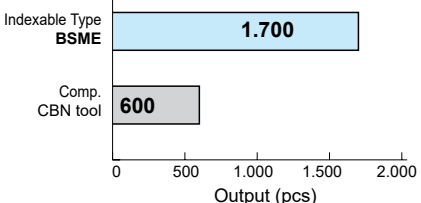
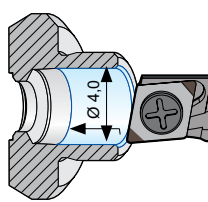
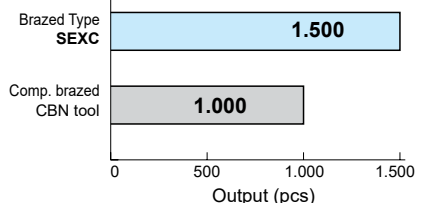
BSME Hardened Alloy Steel Valve Component	SEXC Bearing Steel Small Automotive Component												
<p>The BSME type provides stable machining. Tool life is over 2 times longer than competitor's CBN tool.</p>   <table border="1"> <caption>Output Comparison for BSME</caption> <tr> <th>Tool Type</th> <th>Output (pcs)</th> </tr> <tr> <td>Indexable Type BSME</td> <td>1.700</td> </tr> <tr> <td>Comp. CBN tool</td> <td>600</td> </tr> </table>	Tool Type	Output (pcs)	Indexable Type BSME	1.700	Comp. CBN tool	600	<p>The SEXC type provides drastically reduced tool costs. Tool life is 1,5 times longer than competitor's brazed CBN tool.</p>   <table border="1"> <caption>Output Comparison for SEXC</caption> <tr> <th>Tool Type</th> <th>Output (pcs)</th> </tr> <tr> <td>Brazed Type SEXC</td> <td>1.500</td> </tr> <tr> <td>Comp. brazed CBN tool</td> <td>1.000</td> </tr> </table>	Tool Type	Output (pcs)	Brazed Type SEXC	1.500	Comp. brazed CBN tool	1.000
Tool Type	Output (pcs)												
Indexable Type BSME	1.700												
Comp. CBN tool	600												
Tool Type	Output (pcs)												
Brazed Type SEXC	1.500												
Comp. brazed CBN tool	1.000												
<p>Work Material: Hardened alloy steel valve component (automotive component)                      Tool: BSME R50020D2S6                      Grade: BN2000                      Cutting Conditions: <math>v_c = 135</math> m/min  <math>f = 0,02</math> mm/rev  <math>a_p = 0,10</math> mm                      Dry</p>	<p>Work Material: Bearing steel small automotive component (60 HRC)                      Holder: E06D2 SEXC R/L03-04P                      Insert: ECXA 030X02LF (BN2000)                      Cutting Conditions: <math>v_c = 50</math> m/min (4.000 rpm)  <math>f = 0,02</math> mm/rev  <math>a_p = 0,02</math> mm                      Wet</p>												

# BSME Series

## BSME-Type with Internal Coolant

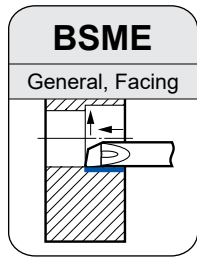

Fig. 1

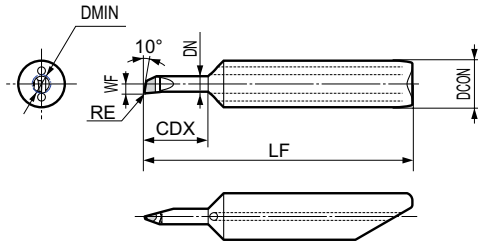
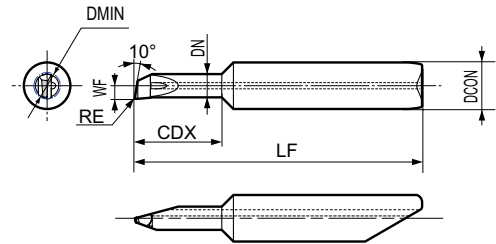

Fig. 2



Sharp edge (no honing)

### Boring Bar

Description	Grade		Dimensions (mm)							Fig.	Applicable Sleeve
	BN2000		DMIN	DN	WF	CDX	LF	DCON	RE		
	R	L									
BSME R/L 25020D2S6	●	●	2,5	2,0	1,20	5,3	32,0	6,0	0,2	1	HBSM6020
BSME R/L 25020D3S6	●	●				7,8	34,5				
BSME R/L 25020D4S6	□	□				10,3	37,0				
BSME R/L 30020D2S6	●	●	3,0	2,5	1,45	6,3	32,8				
BSME R/L 30020D3S6	●	●				9,3	35,8				
BSME R/L 30020D4S6	□	□				12,3	38,8				
BSME R/L 35020D2S6	●	●	3,5	3,0	1,70	7,3	33,5				
BSME R/L 35020D3S6	●	●				10,8	37,0				
BSME R/L 35020D4S6	□	□				14,3	40,5				
BSME R/L 40020D2S6	●	●	4,0	3,5	1,95	8,3	33,9				
BSME R/L 40020D3S6	●	●				12,3	37,9				
BSME R/L 40020D4S6	□	□				16,3	41,9				
BSME R/L 45020D2S6	●	●	4,5	4,0	2,20	9,3	35,0				
BSME R/L 45020D3S6	●	●				13,8	39,5				
BSME R/L 45020D4S6	□	□				18,3	44,0				
BSME R/L 50020D2S6	●	□	5,0	4,5	2,45	10,3	35,8				
BSME R/L 50020D3S6	●	●				15,3	40,8				
BSME R/L 50020D4S6	□	□				20,3	45,8				

### Adapter Sleeve and Parts

Description	Stock	Dimensions (mm)		Sleeve Screw	Wrench
		DCB	LF		
HBSM6020	●	6,0	80	BT0506	TH025

### Alignment Tool

Description	Stock
AFBSM60	●

### Identification Details

**B S M**

Sumitomo CBN Product Special Mini

**E**

Solid Carbide Bar with Inner Coolant

**R/L**

R: Right Hand  
L: Left Hand

**3 5 0**

Minimum Bore Diameter (ø 3,5 mm)

**2 0**

Nose Radius of Edge (ø 0,20 mm)

**D 3**

L/D - Ratio of Working Length

**S 6**

Shank Diameter

● = Euro stock  
□ = Delivery on request

Recommended Tightening Torque (N·m)

# SEXC Series

## SEXC-Type with Internal Coolant

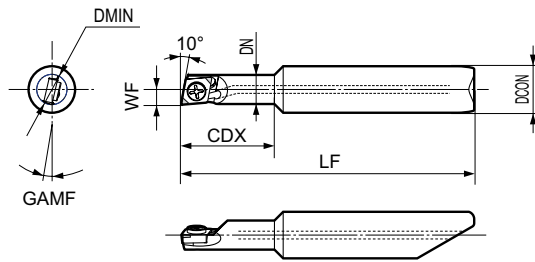
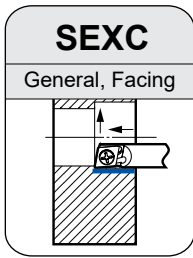

### Spare Parts

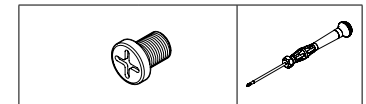

### Boring Bar

Description	Stock		Dimensions (mm)							Applicable Sleeve	Insert Screw	N·m	Wrench
	R	L	DMIN	DN	WF	CDX	LF	DCON	GAMF				
E06D2 SEXC R/L 03-04P	●	●	4,0	3,75	1,95	8	33,75	6,0	13°	HBSM6020	MIB1,6-2,0	0,2	SDBSM
E06D3 SEXC R/L 03-04P	●	●				12	37,75						
E06D2 SEXC R/L 03-05P	●	●	5,0	4,75	2,45	10	35,25	12°					
E06D3 SEXC R/L 03-05P	●	●				15	40,25						
E06D2 SEXC R/L 03-06P	●	●	6,0	5,75	2,95	12	36,75	11°	MIB1,6-3,0				
E06D3 SEXC R/L 03-06P	●	●				18	42,75						

### Adapter Sleeve and Parts

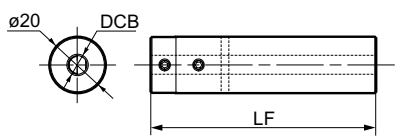

Description	Stock	Dimensions (mm)		Sleeve Screw	Wrench
		DCB	LF		
HBSM6020	●	6,0	80	BT0506	TH025

### Alignment Tool

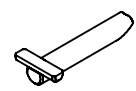

Description	Stock
AFBSM60	●

### CBN Insert

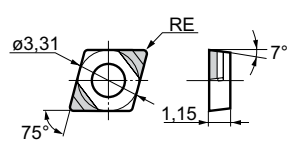

Description	Grade		Nose Radius RE (mm)	Cutting Edge Preparation
	BN2000	BN7000		
ECXA030X02 LE NU2	●		0,2	sharp + hone
ECXA030X02 LF NU2	●	●	0,2	sharp

#### Notes:

Applicable wrench SDBSM is recommended when fastening the insert screw. Please check insert screw occasionally and replace it in time.

### Identification Details

<b>E</b>	<b>06</b>	<b>D2</b>	<b>S</b>	<b>E</b>	<b>X</b>	<b>C</b>	<b>R/L</b>	<b>03</b>	<b>-</b>	<b>04</b>	<b>P</b>
Carbide Bar with Coolant Hole	Shank Diameter (ø 6 mm)	L/D Ratio of Working Length	Insert Clamp System S = Screw Type	Insert Shape E = Diamond 75°	Approach Angle of Main Cutting Edge	Insert Relief Angle C = 7°	R: Right Hand L: Left Hand	Insert Size (ø IC)		Minimum Bore Diameter (ø 4,0 mm)	Standard Content includes Wrench

# SUMIBORON Small Hole Boring Tools BNBB Type

For Hardened Steel

BNBB type small hole boring tools for hardened work pieces up to diameter 3,5 mm

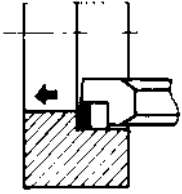

## ■ „Sumiboron“ Brazed Boring Tools for Small Hole Boring

	Cat. No.	Stock	Dimensions (mm)					Applicable holder	Grade of brazed cutting edge
			DMIN	DCON	LF	H	RE		
BNBB (Carbide shank) 	BNBB 03 R	▲	3,5	3	60	2,4	0,2	HBB 316	<b>SUMIBORON (CBN)</b>  <b>BN250</b>
	BNBB 04 R	▲	4,5	4	60	3,4	0,2	HBB 416	
	BNBB 05 R	▲	5,5	5	80	4,4	0,2	HBB 516	
	BNBB 06 R	▲	6,5	6	80	5,4	0,2	HBB 616	
	BNBB 08 R	▲	8,5	8	100	7,4	0,2	HBB 816	

## ■ Holder

	Cat. No.	Stock	Dimensions (mm)				Screw	Wrench
			d <sub>1</sub>	LF	d <sub>2</sub>	H		
	HBB 316	●	16	100	3	15		TH 020
	HBB 416	●			4			
	HBB 516	●			5			
	HBB 616	●			6			
	HBB 816	●			8			

## ■ Spare Parts

## ■ Recommended Cutting Conditions

Work Material	SUMIBORON BN250		Notes
Hardened steels (H <sub>R</sub> C45-68)	Cutting speed (v <sub>c</sub> )	30-150 m/min	Low speed may cause chattering in cutting process and chipping occurrence on the cutting edge.
	Feed rate (f)	0,03-0,1 mm/rev	-
	Depth of cut (a <sub>p</sub> )	0,03-0,2 mm	Excessive depth of cut may cause larger deformation of tool, resulting in deterioration of bore accuracy.

## ■ Precaution On Use

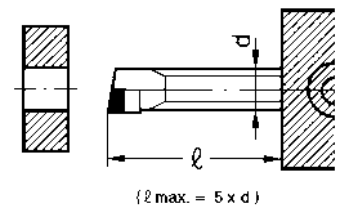

- Adjust overhang to achieve absolute minimum.
- For use of a small diameter brazed boring tool, select high speed and small feed rate, as much as possible.

BNZ type

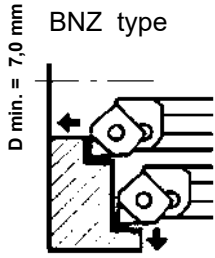

BNB type

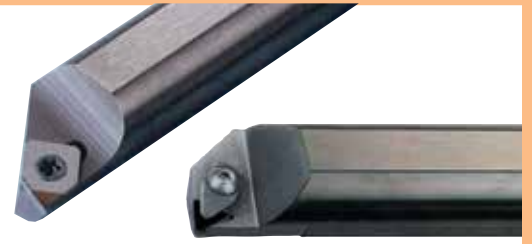
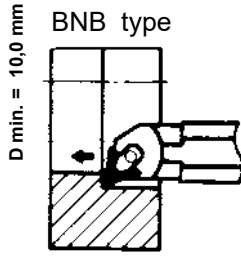

## Boring Bars for Small Hole Boring

	Cat. No.	Stock	Dimensions (mm)					Applicable insert	
			DMIN	DCON	LF	H	GAMF		
<b>BNZ (Carbide shank)</b> 	BNZ 606 R	●	7	6	80	5,5	-14°	ZNEX 040100	 ZNEX (CBN)
	BNZ 608 R	●	9	8	100	7,5	-12°		
	BNZ 610 R	●	11	10	125	9,5	-10°		
	BNZ 612 R	●	13	12	130	11	-8°		
	Holder "HBB616" for BNZ606 (ø d = 6 mm) 								
<b>BNB (Carbide shank)</b> 	BNB 508 R/L	● ●	10	8	140	7	-9°	TBGN 060100	 TBGN (CBN)
	BNB 510 R/L	○ □	12	10	140	9	-8°		
	BNB 512 R/L	● ●	14	12	160	11	-6°		
	BNB 516 R/L	● ●	18	16	180	14	-5°		
	BNB 520 R/L	● ●	22	20	180	18	-4°		

## Spare Parts for BNZ

Holder	Screw	Wrench
BNZ 606 R		
BNZ 608 R	BFTX 0204 N	TRX 06
BNZ 610 R	0,5 (Nm)	

## Spare Parts for BNB

Holder	Clamp	Clamp bolt	Nut	Wrench
BNB 508 R/L	BNBC	BH 0306	BNBW-2	TH 020
BNB 512 R/L	BNBC	FBUP-3-A0-9	BNBW-4	TH 020
BNB 516 R/L	BNBC	BH 0310	BNBW-4	TH 020
BNB 520 R/L	BNBC	BH 0310	BNBW-7	TH 020

## Recommended Cutting Conditions

Cutting speed	80–120 m/min
Feed rate	0,03–0,1 mm/rev
Depth of cut	0,03–0,2 mm

## Holders Performance Area

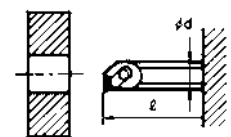
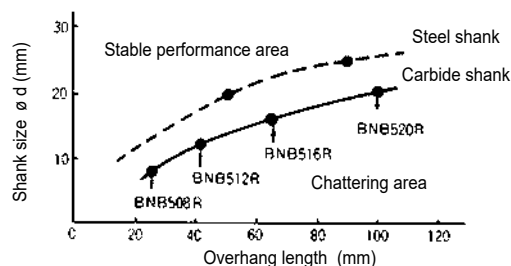

Work material: Alloy steel (HRC 60)  
 Cutting conditions:  $v_c = 100$  m/min  
 $f = 0,1$  mm/rev  
 $a_p = 0,2$  mm



# SUMIBORON Grooving Tool Holder GWB / PSC Type

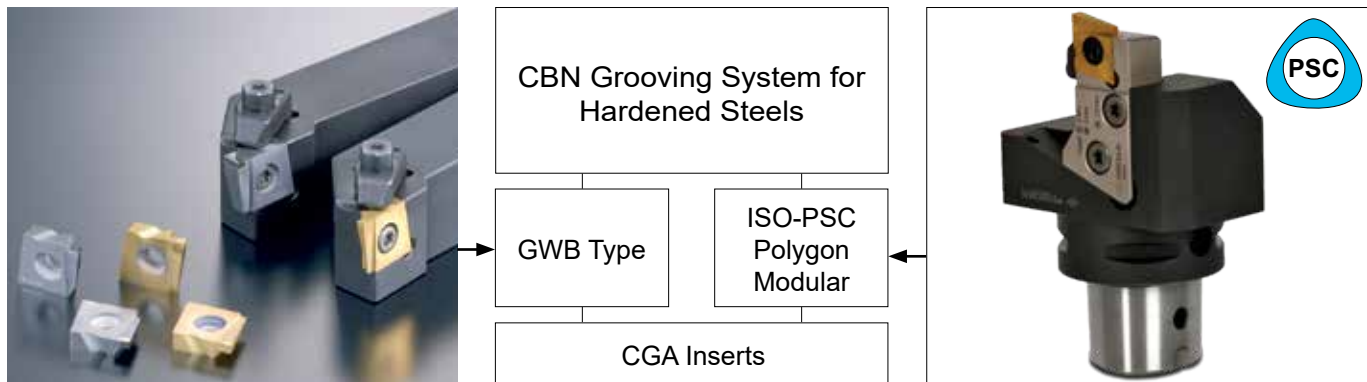

## Features

### Tangential insert

80 degree tangentially mounted insert improves rigidity



### Coated CBN grade BNC30G

Tough new coated CBN grade for interrupted hard grooving



### Double clamping system

The double clamping system increases stability so even axial feeds are possible.

### Wide insert range 1,5–6,0 mm

Wide range of width's and grades for continuous and interrupted cut grooving operations

## Grades

Grade	Application	Features
BN250	Continuous grooving	Uncoated CBN grade for continuous cut grooving applications
BNC30G	Interrupted grooving	Tough new CBN coated grade developed for interrupted cut grooving applications

## Grooving Tool Holder GBW Type

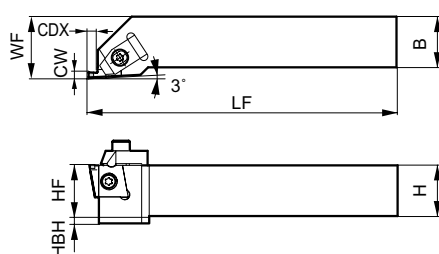
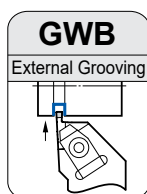

## Spare Parts

Clamp finger	Clamp screw	Insert screw	Spring	Wrench
TF 72 (Right handed)	BX 0520T	BFTX 0511N	GSP 06	TRX 20
TF 73 (Left handed)				

## Holders

Cat. No.	Stock		Dimensions (mm)								Appl. Insert No.	Clamp finger	Clamp screw	Insert screw	Spring	Wrench
	R	L	H	B	LF	WF	HF	HBH	CW (*)	CDX						
GWB R/L 2020-45	□	□	20	20	151 (150)	25	20	5	1,5 ≤ cw ≤ 4,5	3,5 – 5,0	1	TF 72 (Right handed)	BX 0520T	BFTX 0511N	GSP 06	TRX 20
GWB R/L 2525-45	●	●	25	25	151 (150)	30	25	–								
GWB R/L 2525-60	●	●	25	25	151	30	25	–	4,5 ≤ cw ≤ 6,0	5,0	2	TF 73 (Left handed)				

Right handed tool holders are applicable with right handed inserts.

Remark: Inserts are not included.

# SUMIBORON Grooving Tool Holder GWB / PSC Type

## ISO-PSC Polygon Modular CGA Grooving System

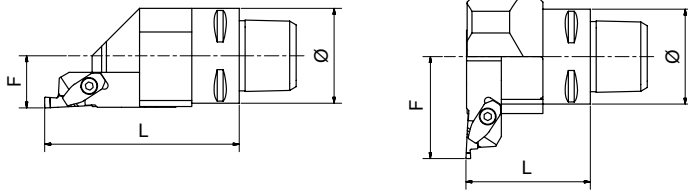

### ■ Holders

Cat. No.	R	L	Ø (mm)	F (mm)	L (mm)	7,5 (Nm)	
						Cap Screw	Wrench
PSC 40GM00 R/L	●	●	40	22	82,0	BFTX0619N	LT25
PSC 50GM00 R/L	●	●	50	27			
PSC 40GM90 R/L	●	●	40	43			
PSC 50GM90 R/L	●	●	50	48			

### ■ Cassette

Cat. No.	R	L	Grooving Width (mm)	Grooving Depth (mm)	Inserts	5,0 (Nm)		Spring	Clamp Finger	3,0 (Nm)	
						Insert Screw	Wrench			Cap Screw	Wrench
GWBCM R/L 45	●	●	1,5-2,0	3,5	CGA1504□□□	BFTX0511N	TRX20		SCP4A		LH030
			2,5-3,0	4,0							
GWBCM R/L 60	●	●	3,5-6,0	5,0	CGA1506□□□						

### ■ CGA Inserts

Cat. No.	Stock						Dimensions (mm)				Insert No.	Applicable Holder
	BN250		BNC30G		BN2000		CW	CDX	IC	S		
	R	L	R	L	R	L						
CGA R/L 1504 150	▲	▲	●	●			1,5	3,5	15,875	4,76	GWB R/L 2020-45 GWB R/L 2525-45 GWBCM R/L-45	
R/L 1504 200	▲	▲	●	□		○	2,0					
R/L 1504 250	▲	▲	●	●			2,5					
R/L 1504 300	▲	▲	●	●			3,0					
R/L 1504 350	▲	▲	●	●			3,5					
R/L 1504 400	▲	▲	●	□			4,0					
R/L 1504 450	▲	▲	□	●			4,5	5,0	6,35		GWB R/L 2525-60 GWBCM R/L-60	
CGA R/L 1506 500	▲	▲	●	●		○	5,0					
R/L 1506 550	▲	▲	●	●			5,5					
R/L 1506 600	▲	▲	●	□			6,0					

Special widths available on request

### ■ Recommended Cutting Conditions

Material	Hardened steel
Cutting speed (m/min)	60 — 80 — 120 — 150
Feed rate (mm/rev)	0,03 — 0,04 — 0,08 — 0,1
Grade	BN250, BNC30G

Coolant:  
Dry / wet (for continuous cut)  
Dry only (for interrupted cut)

Remarks:  
To avoid thermal cracking of the cutting edge when interrupted cutting please ensure workpiece remains dry.

# SUMIBORON Threading Tool Holder BNGG Type

For Hardened Steel

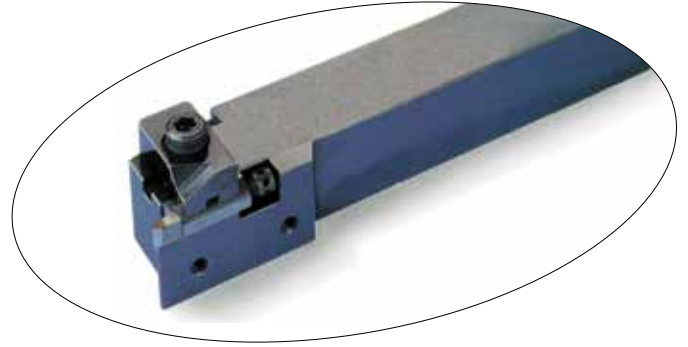
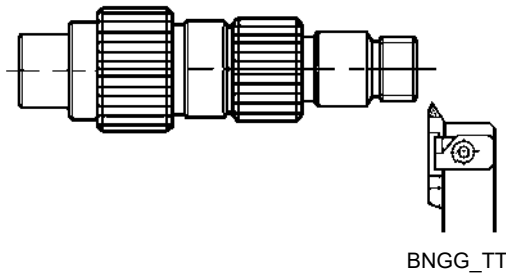

## „Sumiboron“ Holders

	Cat. No.	Stock		Dimensions (mm)			Applicable Insert
		R	L	WF	CDX	LF	
	BNGG R/L 2525-TT	▲	□	28,5	5	150	BNTT 1020 R/L BNTT 1530 R/L

## Inserts

	Cat. No.	Stock				Dimensions (mm)				Applicable Holder
		BN250		BNX20		Pitch	RE	LF	S	
		R	L	R	L					
	BNTT 1020 R/L	▲	▲	●	□	1,0–2,0	0,14	25	6,0	BNGG R/L 2525 - TT
	BNTT 1530 R/L	▲	▲	●	□	1,5–3,0	0,2	25	6,0	

• Inserts also suitable for existing BNG2525R type holders

## Spare Parts

Holder	Support	Clamp	Adjust screw	Spring	Screw	Wrench	
BNGG R/L 2525 - TT	BNGS R/L TT	BNGC R/L	FMJ	GSP 6	BX 0615 LH 050 (for clamp)	LH 030 LH 030 (for support)	
						ø1,8x45	

## Recommended Cutting Conditions

Threading	
Cutting speed (v <sub>c</sub> )	80–120 m/min
Feed rate (f)	Max. pitch: 3,0 mm

● = Euro stock  
□ = Delivery on request

▲ = To be replaced by new item

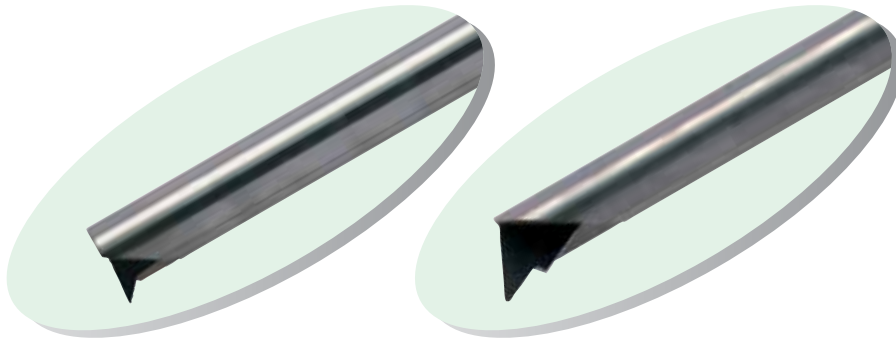

## ■ „Sumidia“ Brazed Boring Tools for Small Hole Boring

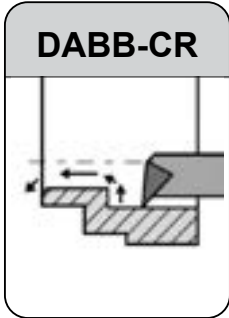

**DABB-CR**

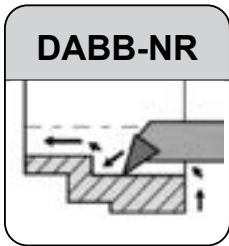

**DABB-NR**

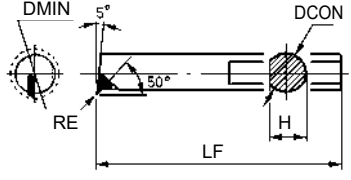
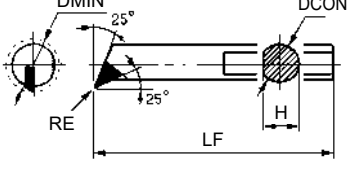
DABB (Solid carbide shank)	Cat. No.	Stock	Dimensions (mm)					Applicable Holder
		DA2200	DMIN	DCON	LF	H	RE	
For small boring 	DABB 025 CR	▲	3,0	2,5	60	2,2	0,1	HBB 2516
	DABB 035 CR	▲	4,0	3,5	60	3,2	0,1	HBB 3516
	DABB 045 CR	▲	5,0	4,5	80	4,1	0,1	HBB 4516
	DABB 060 CR	▲	7,0	6,0	80	5,2	0,1	HBB 616
For profiling and corner grooving 	DABB 025 NR	▲	3,0	2,5	60	2,2	0,1	HBB 2516
	DABB 035 NR	▲	4,0	3,5	60	3,2	0,1	HBB 3516
	DABB 045 NR	▲	5,0	4,5	80	4,1	0,1	HBB 4516
	DABB 060 NR	▲	7,0	6,0	80	5,2	0,1	HBB 616

## ■ Recommended Cutting Conditions

Spindle revolution	Feed rate	Depth of cut	Coolant
> 2000 rpm	0,03 – 0,1 mm/rev	0,03 – 0,2 mm	Wet

## ■ Holder

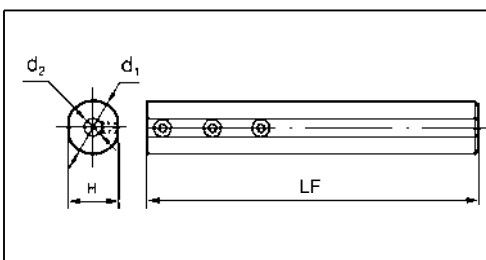

Cat. No.	Stock	Dimensions (mm)			
		d <sub>1</sub>	LF	d <sub>2</sub>	H
HBB 2516	●	16	100	2,5	15
HBB 3516	●			3,5	
HBB 4516	●			4,5	
HBB 616	●			6,0	

## ■ Spare Parts

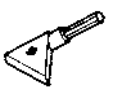
Screw	Wrench
 BT 0404	 TH 020



### ■ Features

- **Drastically Reduced Runout Adjustment Time**  
Simple screw-fastening structure enables fine adjustments to be made easily.
- **Blade Through Coolant**  
Secures a supply of coolant to the cutting edge and breaks chips thoroughly.
- **Lightweight Aluminum Alloy Body**  
Utilizing aluminum alloy to achieve a total weight of less than 1,3 kg for a Ø 125 mm cutter with 22 teeth.

### ■ Product Range

Type	Cat. No.	Body Material	Diameter Range (mm) / No of Teeth										
			Ø 25	Ø 30	Ø 32	Ø 40	Ø 50	Ø 63	Ø 80	Ø 100	Ø 125	Ø 160	
Shell	ANXA 16000RS	Aluminum Alloy								6, 10, 14	8, 12, 18	10, 14, 22	12, 20, 28
	ANXA 16000R (Inch)	Aluminum Alloy	→ G78							6, 10, 14	8, 12, 18	10, 14, 22	12, 20, 28
	ANXS 16000RS	Steel				4, 6	4, 6, 9	6, 8, 12	6, 10, 14	8, 12, 18	10, 14, 22		
	ANXS 16000R (Inch)	Steel	→ G80						6, 8, 12	6, 10, 14	8, 12, 18	10, 14, 22	
Shank	ANXS 16000E	Steel	2	3, 4	3, 4	4, 6	4, 6, 9		→ H84				
Modular	ANXS 16000M	Steel	2	3, 4	3, 4	4, 6			→ H86				

[Inch] Inch Bore

### ■ Blade Selection Guide

Work Material	N								
Applications	Finishing / Light Cutting	General Purpose	Roughing		Combined Milling *1	Corner Radius Milling	Corner Radius Milling	Finishing	Burr-free / Mirror Finishing
Features	Low Cutting Force	Standard	Long Edge	High Strength	High Strength	Corner Radius 0,4	Corner Radius 0,8	Wiper	Wiper
Type	L	G	GX	H	GB	-	-	W	WS
Cutting Edge Shape									
Edge Length(*2)	6,0 mm	6,0 mm	9,0 mm	6,0 mm	6,0 mm	6,0 mm	6,0 mm	2,0 mm	-

\*1 Machining of components combining aluminum alloy and cast iron

### ■ Edge Selection Guide

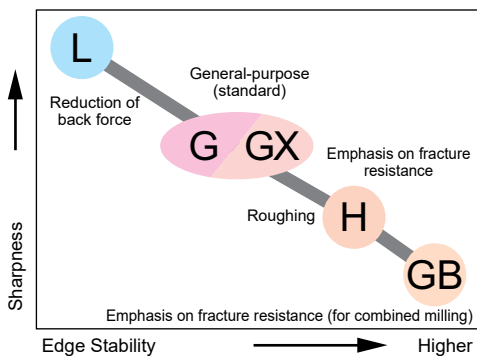

\*2 Edge length  
GX type = 9,0 mm

- **Reduces Running Costs by Drastically Increasing Blade, Insert Regrinding Allowance (to 1,0 mm)**

Assuming 0,2 mm of regrinding each time, an edge can be used up to 6 times. (Peripheral edge cannot be reground.)



If you wish to use reground blades you shall use sets of blades with matching size of the same level in order to keep the balance.

## ■ Performances

### ● High-Speed / High-Efficiency Cutting

Realizes ultra-high efficiency machining with  $v_f = 30.000$  mm/min



Comparison: Cutter Diameter  $\varnothing$  100 mm

	Spindle Speed min <sup>-1</sup>	Number of Teeth	Feed Rate $v_f$ (mm/min)
ANX Series	18.000	18	32.400
Competitor	9.500	12	11.400

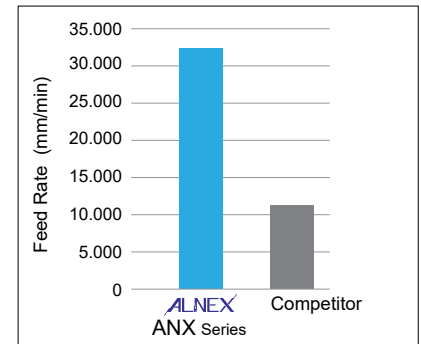

### ● Drastically Reduces Runout Adjustment Time

- Simple screw-fastening structure
- Enables fine adjustments to be made easily
- High-rigidity body

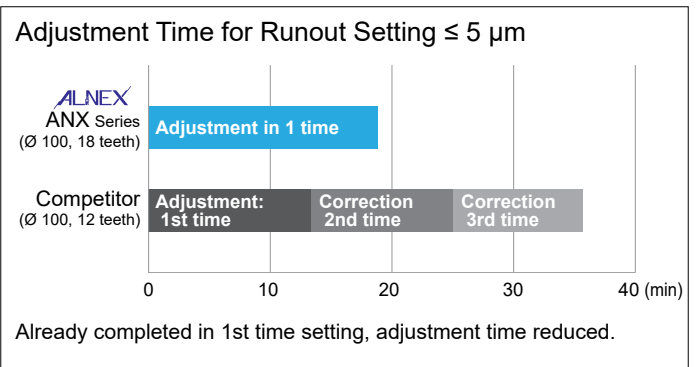
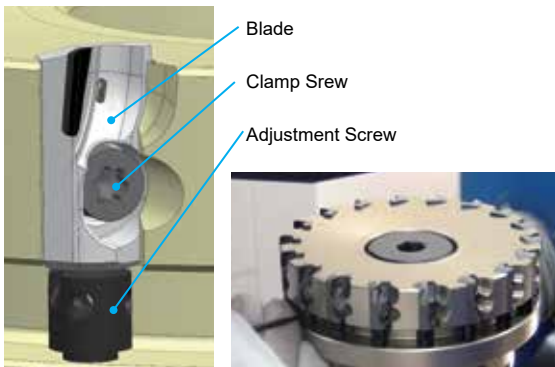

### ● Chip Control



### Blade-Through Coolant Chip Breaking

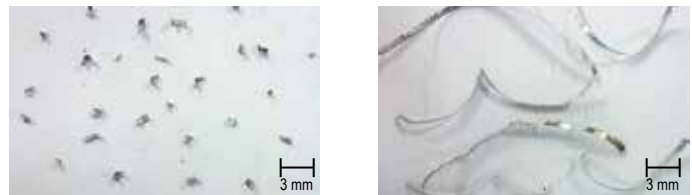

ALNEX ANX Series	Competitor
Work Material:	G-AlSi12Cu
Cutting Conditions:	$v_c = 2500$ m/min, $f_z = 0,05$ mm/t, $a_p = 0,5$ mm, wet

## ■ Adjustment of the Blades, Runout Alignment

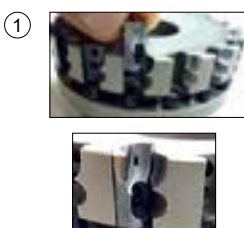

Insert the blade into its seat.

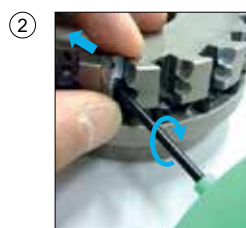

While holding the blade against the seat, install the clamping bolt using the provided wrench, pre-tightening the bolt. (recommended pre-torque is 1 N·m)

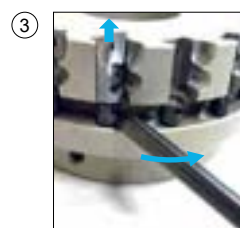

Using the provided wrench for the height adjustment screw, set the height to your predetermined value.



Fully tighten the clamp bolt. (recommended torque is 2 N·m)





## ■ CVD Single Crystal Diamond SCV10 Wiper Blade

Wiper blade adopts high-strength single-crystal diamond using Sumitomo Electric Hardmetal's vapour phase synthesis technology.

Sharp cutting edge realises burr-free, mirror finish surface quality in aluminum alloy machining.

Superior wear resistance maintains cutting edge sharpness for a long time, reducing total tool costs.

## ■ Burr-free

Sharp cutting edge and excellent wear resistance suppress burrs over the long term.

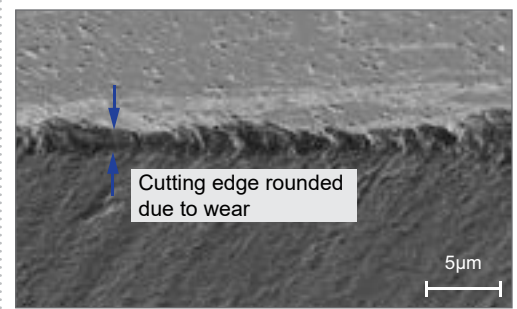
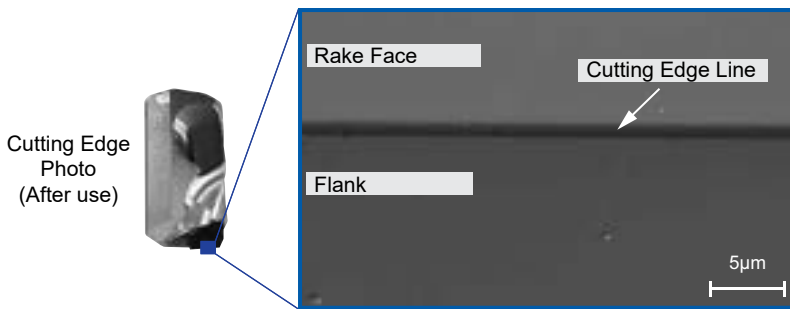
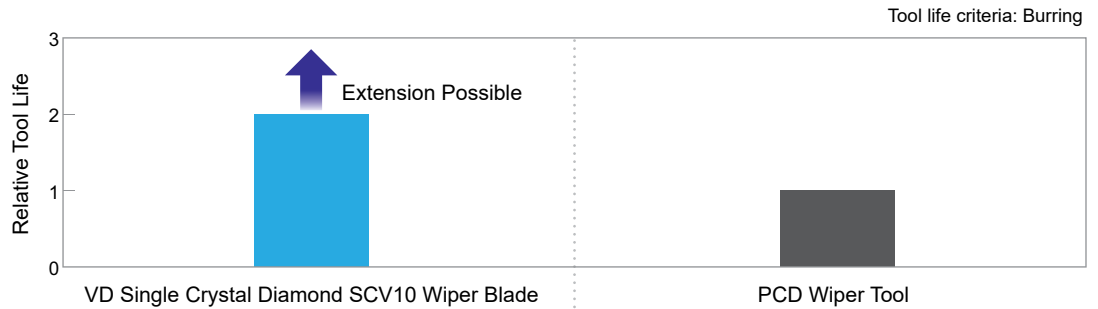

## ■ Mirror Finishing

Sharp cutting edge achieves mirror finish with cutting alone.

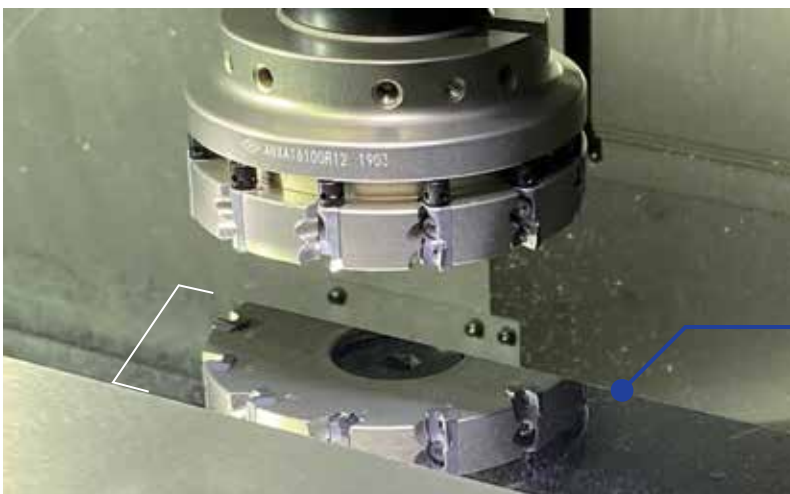

Workpiece surface after machining



## ■ Polycrystalline Diamond SUMIDIA DA1000 / DA90

Through the ideal combination of diamond particle size and binder, SUMIDIA DA1000/DA90 possess various features and is suitable for all kinds of applications such as machining of aluminum alloy and cemented carbide.

## ■ Grades, Features and Applications

Grade	Features	Applications	Diamond share (%)	Average grain size of diamond particles (μm)	Hardness HK (GPa)	TRS (GPa)
DA1000	High-density sintered grade made of ultra-fine grain diamond that exhibits excellent wear and fracture resistance as well as edge sharpness.	Machining of High-Silicon Aluminum Alloy, Rough, Interrupt and Finish Machining of Aluminum Alloy, Woodcraft or Wooden Board Cutting/Facing, General Finishing of Non-Ferrous Metals	90–95	≤ 0,5	50–60	≈ 2,60
DA90	Contains coarser diamond particles than other grades, giving it good wear resistance suitable for the machining of carbides and high-silicon aluminum. Shows the highest diamond content for excellent wear resistance.	Machining of High-Silicon Aluminum Alloy, Machining of Aluminum Composite (MMC), Green or Semi-Sintered Cemented Carbide & Ceramic Roughing, Machining of Sintered Ceramic/Stone/Rock	90–95	≤ 50	50–65	≈ 1,10

## ■ Grade Applications

	Work Material	Applicable Grade	Example Parts
Aluminum	Sintered Aluminum, Wrought Aluminum Alloy	DA1000	Piston Liners, Machine Parts, etc.
	Alloys for Die Casting		Transmission Case, Oil Pan, Cylinder Block
	Alloys for Casting Low Si (≤ 12%)		Cylinder Head
	Alloys for Casting High Si (> 12%)		Cylinder Block
Non-ferrous metal	Non-Ferrous Sintered Alloy	DA1000	Bush
	Gunmetal, Carbon		Connecting Rod
	Fe Combined	DA90	Cylinder Block, Bearing Cap

# Alnex ANXA 16000 R(S)

Expansion

Rake Angle	Radial	+5°	3 mm	90°
	Axial	+5°		

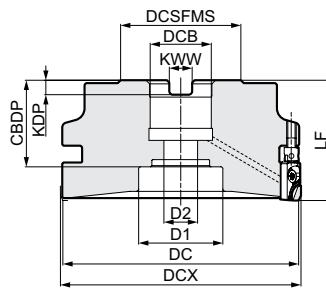

## Body - ANXA (Aluminum Alloy)

Dimensions (mm)

	Cat. No.	Stock	DC	DCX	DCSFMS	Lf	DCB	KWW	KDP	CBDP	D1	D2	No. of Teeth	Weight (kg)
Metric	ANXA 16080RS06	○	78	80	50	50	27	12,4	7	34	35	14	6	0,5
	16080RS10	●	78	80	50	50	27	12,4	7	34	35	14	10	0,5
	16080RS14	●	78	80	50	50	27	12,4	7	34	35	14	14	0,5
	16100RS08	○	98	100	50	59	27	12,4	7	34	35	14	8	0,8
	16100RS12	●	98	100	50	50	27	12,4	7	34	35	14	12	0,8
	16100RS18	●	98	100	50	50	27	12,4	7	34	35	14	18	0,9
	16125RS10	○	123	125	50	50	27	12,4	7	34	35	14	10	1,2
	16125RS14	●	123	125	50	50	27	12,4	7	34	35	14	14	1,2
	16125RS22	●	123	125	50	50	27	12,4	7	34	35	14	22	1,3
	16160RS12	○	158	160	80	63	40	16,4	9	35	52	29	12	2,6
	16160RS20	○	158	160	80	63	40	16,4	9	35	52	29	20	2,6
16160RS28	○	158	160	80	63	40	16,4	9	35	52	29	28	2,6	
Inch	ANXA 16080R06	○	78	80	50	50	25,4	9,5	6	34	35	14	6	0,5
	16080R10	○	78	80	50	50	25,4	9,5	6	34	35	14	10	0,5
	16080R14	○	78	80	50	50	25,4	9,5	6	34	35	14	14	0,5
	16100R08	○	98	100	50	50	25,4	9,5	6	34	35	14	8	0,8
	16100R12	○	98	100	50	50	25,4	9,5	6	34	35	14	12	0,9
	16100R18	○	98	100	50	50	25,4	9,5	6	34	35	14	18	0,9
	16125R10	○	123	125	50	50	25,4	9,5	6	34	35	14	10	1,2
	16125R14	○	123	125	50	50	25,4	9,5	6	34	35	14	14	1,2
	16125R22	○	123	125	50	50	25,4	9,5	6	34	35	14	22	1,3
	16160R12	○	158	160	80	63	38,1	15,9	10	42,5	55	30	12	2,3
	16160R20	○	158	160	80	63	38,1	15,9	10	42,5	55	30	20	2,4
16160R28	○	158	160	80	63	38,1	15,9	10	42,5	55	30	28	2,6	

Blades are sold separately. If using a blade for corner radius machining (ANB1604R/ANB1608R), DC = DCX.

The weight includes the weight of the blade and parts (excluding the centre bolt).

All aluminium alloy bodies with a maximum blade diameter (DCX) of Ø 80 to Ø 125 have the same diameter (DCB) of the retainer hole (metric Ø 27/in Ø 25,4).

## Identification Details

<b>ANX</b>	<b>A</b>	<b>16</b>	<b>100</b>	<b>R</b>	<b>S</b>	<b>18</b>
Cutter Series	Aluminum Alloy Body	Blade Size	Cutter Diameter	Feed Direction	Metric	Number of Teeth

## Blades

Dimensions (mm)

Application	SUMIDIA	CVD						
High Speed / Light Cut	<b>N</b>	<b>N</b>	<b>N</b>					
General Purpose	<b>N</b>	<b>N</b>	<b>N</b>					
Roughing	<b>N</b>	<b>N</b>	<b>N</b>					
Cat. No.	DA1000	DA90	SCV10	Cutting Edge Length	RE	Wiper Edge Shape	Applications	Fig.
ANB 1600R-L	●	—	—	6,0	—	Linear	Low Cutting Force	1
1600R-G	●	—	—	6,0	—	Arc-Shaped	General Purpose	1
1600R-GB	●	●	—	6,0	—	Arc-Shaped	Combined Milling*	1
1600R-H	●	—	—	6,0	—	Arc-Shaped	Strong Edge	1
1600R-GX	○	—	—	9,0	—	Arc-Shaped	Long Edge	2
1604R	○	—	—	6,0	0,4	Linear	Corner Radius	3
1608R	○	—	—	6,0	0,8	Linear	Corner Radius	3
1600R-W	○	—	—	2,0	—	Arc-Shaped	Wiper	4
1600R-WS	—	—	□	—	—	Arc-Shaped	Wiper	5

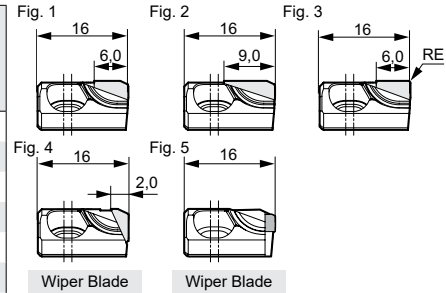

\* Cast Iron/Aluminum Alloy

## Recommended Cutting Conditions

Si content ≤ 12,6 %

Min. - Optimum - Max.

ISO	Work Material	Hardness	Cutting Speed $v_c$ (m/min)	Feed Rate $f_z$ (mm/t)	Grade
<b>N</b>	Aluminum Alloy	—	2.000–2.500–3.000	0,05–0,13–0,20	DA1000

Si content > 12,6 %

Min. - Optimum - Max.

ISO	Work Material	Hardness	Cutting Speed $v_c$ (m/min)	Feed Rate $f_z$ (mm/t)	Grade
<b>N</b>	Aluminum Alloy	—	400–600–800	0,05–0,13–0,20	DA1000 DA90

Combined Milling of Cast Iron/Aluminum Alloy

Min. - Optimum - Max.

ISO	Work Material	Hardness	Cutting Speed $v_c$ (m/min)	Feed Rate $f_z$ (mm/t)	Grade
<b>K</b> <b>N</b>	Cast Iron/ Aluminum Alloy	—	300–400–500	0,05–0,13–0,20	DA90

The above recommended cutting conditions are meant as a guide. Actual conditions will depend on the individual machine rigidity, work clamp rigidity, depth of cut and other factors.

## Spare Parts

Sold separately.

Applicable Cutters	Clamp Screw		Adjustment Screw	Wrench	Adjustment Wrench	Centre Bolt		Assembly Wrench
ANXA 16080R(S)_ 16100R(S)_ 16125R(S)_ 16160R(S)_	BXA0310IP	2,0	HFJ	TRXW10IP	ANT	BXH1235-D33	50	HFVT
						BXH2036-D50	200	

The adjustment spanner (ANT) can also be used for height adjustment of the RF type cutters for high speed machining and the HF type cutters for high efficiency machining.

## Wiper Blade Step Amount

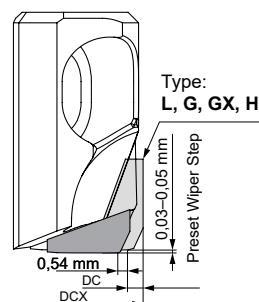

When using the wiper blade, in order to maintain balance, be sure to use a cutter with an even number of cutting edges and place the wiper blades at opposite positions.

## Max. Allowable Spindle Speed

Cat. No.	n max (min <sup>-1</sup> )
ANXA 16080RS06	20.000
16080RS10	20.000
16080RS14	20.000
16100RS08	18.000
16100RS12	18.000
16100RS18	18.000
16125RS10	16.000
16125RS14	16.000
16125RS22	16.000
16160RS12	14.000
16160RS20	14.000
16160RS28	14.000
ANXA 16080R06	20.000
16080R10	20.000
16080R14	20.000
16100R08	18.000
16100R12	18.000
16100R18	18.000
16125R10	16.000
16125R14	16.000
16125R22	16.000
16160R12	14.000
16160R20	14.000
16160R28	14.000

# Alnex ANXS 16000 R(S)

Expansion

Rake Angle	Radial	+5°	3 mm	90°
	Axial	+5°		

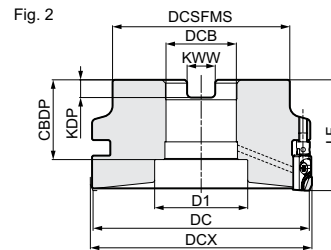
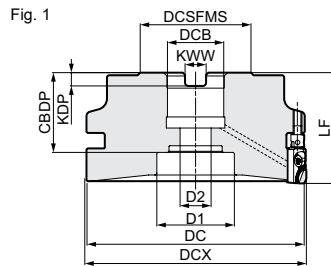

## Body - ANXS (Steel)

Dimensions (mm)

	Cat. No.	Stock	DC	DCX	DCSFMS	LF	DCB	KWW	KDP	CBDP	D1	D2	No. of Teeth	Weight (kg)	Fig.
Metric	ANXS 16040RS04	○	38	40	38,5	40	16	8,4	5,6	26	14	9	4	0,3	1
	16040RS06	●	38	40	38,5	40	16	8,4	5,6	26	14	9	6	0,3	1
	16050RS04	○	48	50	48,5	40	22	10,4	6,3	26	18	11	4	0,4	1
	16050RS06	●	48	50	48,5	40	22	10,4	6,3	26	18	11	6	0,4	1
	16050RS09	○	48	50	48,5	40	22	10,4	6,3	26	18	11	9	0,5	1
	16063RS06	○	61	63	50	40	22	10,4	6,3	26	18	11	6	0,7	1
	16063RS08	●	61	63	50	40	22	10,4	6,3	26	18	11	8	0,7	1
	16063RS12	●	61	63	50	40	22	10,4	6,3	26	18	11	12	0,7	1
	16080RS06	○	78	80	50	40	27	12,4	7	34	35	14	6	1,2	1
	16080RS10	○	78	80	50	50	27	12,4	7	34	35	14	10	1,2	1
	16080RS14	○	78	80	50	50	27	12,4	7	34	35	14	14	1,2	1
	16100RS08	○	98	100	80	50	32	14,4	8	32	46	-	8	1,9	2
	16100RS12	○	98	100	80	50	32	14,4	8	32	46	-	12	2,0	2
	16100RS18	○	98	100	80	50	32	14,4	8	32	46	-	18	2,0	2
	16125RS10	○	123	125	80	63	40	16,4	9	35	52	-	10	3,8	2
16125RS14	○	123	125	80	63	40	16,4	9	35	52	-	14	3,9	2	
16125RS22	○	123	125	80	63	40	16,4	9	35	52	-	22	3,9	2	
Inch	ANXS 16063R06	○	61	63	50	50	25,4	9,5	6	31	20	14	6	0,9	1
	16063R08	○	61	63	50	50	25,4	9,5	6	31	20	14	8	0,9	1
	16063R12	○	61	63	50	50	25,4	9,5	6	31	20	14	12	0,9	1
	16080R06	○	78	80	50	50	25,4	9,5	6	34	35	14	6	1,2	1
	16080R10	○	78	80	50	50	25,4	9,5	6	34	35	14	10	1,2	1
	16080R14	○	78	80	50	50	25,4	9,5	6	34	35	14	14	1,2	1
	16100R08	○	98	100	80	50	31,75	12,7	8	36	42	-	8	1,9	2
	16100R12	○	98	100	80	50	31,75	12,7	8	36	42	-	12	2,0	2
	16100R18	○	98	100	80	50	31,75	12,7	8	36	42	-	18	2,0	2
	16125R10	○	123	125	80	63	38,1	15,9	10	42,5	52	-	10	3,9	2
	16125R14	○	123	125	80	63	38,1	15,9	10	42,5	52	-	14	3,9	2
16125R22	○	123	125	80	63	38,1	15,9	10	42,5	52	-	22	3,9	2	

Blades are sold separately. If using a blade for corner radius machining (ANB1604R/ANB1608R), DC = DCX.  
The weight includes the weight of the blade and parts (excluding the centre bolt).

## Identification Details

<b>ANX</b>	<b>S</b>	<b>16</b>	<b>100</b>	<b>R</b>	<b>S</b>	<b>18</b>
Cutter Series	Steel Body	Blade Size	Cutter Diameter	Feed Direction	Metric	Number of Teeth

● = Euro stock  
○ = Japan stock

□ = Delivery on request

Recommended Tightening Torque (N·m)



# Alnex ANXS 16000 R(S)

Dimensions (mm)

## Blades

Application	SUMIDIA	CVD						
High Speed / Light Cut								
General Purpose								
Roughing								
Cat. No.	DA1000	DA90	SCV10	Cutting Edge Length	RE	Wiper Edge Shape	Applications	Fig.
ANB 1600R-L	●	—	—	6,0	—	Linear	Low Cutting Force	1
1600R-G	●	—	—	6,0	—	Arc-Shaped	General Purpose	1
1600R-GB	●	●	—	6,0	—	Arc-Shaped	Combined Milling*	1
1600R-H	●	—	—	6,0	—	Arc-Shaped	Strong Edge	1
1600R-GX	○	—	—	9,0	—	Arc-Shaped	Long Edge	2
1604R	○	—	—	6,0	0,4	Linear	Corner Radius	3
1608R	○	—	—	6,0	0,8	Linear	Corner Radius	3
1600R-W	○	—	—	2,0	—	Arc-Shaped	Wiper	4
1600R-WS	—	—	□	—	—	Arc-Shaped	Wiper	5

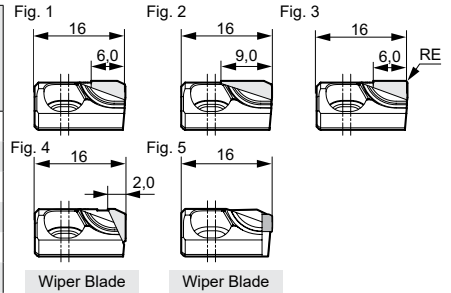

\* Cast Iron/Aluminum Alloy

## Recommended Cutting Conditions

Si content ≤ 12,6 %

Min. - **Optimum** - Max.

ISO	Work Material	Hardness	Cutting Speed $v_c$ (m/min)	Feed Rate $f_z$ (mm/t)	Grade
	Aluminum Alloy	—	2.000– <b>2.500</b> –3.000	0,05– <b>0,13</b> –0,20	DA1000

Si content > 12,6 %

Min. - **Optimum** - Max.

ISO	Work Material	Hardness	Cutting Speed $v_c$ (m/min)	Feed Rate $f_z$ (mm/t)	Grade
	Aluminum Alloy	—	400– <b>600</b> –800	0,05– <b>0,13</b> –0,20	DA1000 DA90

Combined Milling of Cast Iron/Aluminum Alloy

Min. - **Optimum** - Max.

ISO	Work Material	Hardness	Cutting Speed $v_c$ (m/min)	Feed Rate $f_z$ (mm/t)	Grade
 	Cast Iron/ Aluminum Alloy	—	300– <b>400</b> –500	0,05– <b>0,13</b> –0,20	DA90

The above recommended cutting conditions are meant as a guide. Actual conditions will depend on the individual machine rigidity, work clamp rigidity, depth of cut and other factors.

## Spare Parts

Sold separately.

Applicable Cutters	Clamp Screw		Adjustment Screw	Wrench	Adjustment Wrench	Centre Bolt		Assembly Wrench
ANXS 16040RS_	BXA0310IP	2,0	HFJ	TRXW10IP	ANT	BXH0825-D13	15	HFVT
16050RS_						BXH1030-D16	25	
16063RS_						BXH1235-D33	50	
16080RS_						BXH1635-D40	100	
16100RS_						BXH2036-D50	200	
16125RS_	BXH1235-D18	40						
16063R_	BXA0310IP	2,0	HFJ	TRXW10IP	ANT	BXH1235-D33	50	
16080R_						BXH1635-D40	100	
16100R_						BXH2036-D50	200	
16125R_						BXH2036-D50	200	

The adjustment spanner (ANT) can also be used for height adjustment of the RF type cutters for high speed machining and the HF type cutters for high efficiency machining.

## Wiper Blade Step Amount

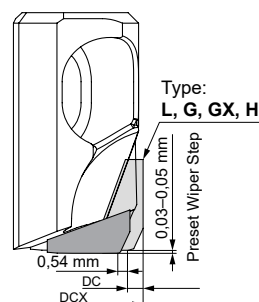

When using the wiper blade, in order to maintain balance, be sure to use a cutter with an even number of cutting edges and place the wiper blades at opposite positions.

## Max. Allowable Spindle Speed

Cat. No.	n max (min <sup>-1</sup> )
ANXS 16040RS04	25.000
16040RS06	25.000
16050RS04	25.000
16050RS06	25.000
16050RS09	25.000
16063RS06	22.000
16063RS08	22.000
16063RS12	22.000
16080RS06	20.000
16080RS10	20.000
16080RS14	20.000
16100RS08	18.000
16100RS12	18.000
16100RS18	18.000
16125RS10	16.000
16125RS14	16.000
16125RS22	16.000
ANXS 16063R06	22.000
16063R08	22.000
16063R12	22.000
16080R06	20.000
16080R10	20.000
16080R14	20.000
16100R08	18.000
16100R12	18.000
16100R18	18.000
16125R10	16.000
16125R14	16.000
16125R22	16.000



# Alnex ANXS 16000 E

Expansion

Rake Angle	Radial	-2 – 0°	3 mm	90°
	Axial	+5°		

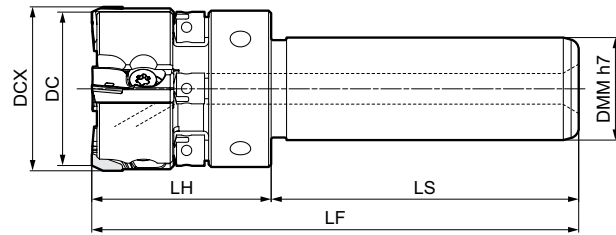

## ■ Body - ANXS (Steel)

Dimensions (mm)

Cat. No.	Stock	DC	DCX	DMM	LH	LS	LF	No. of Teeth	Weight (kg)
ANXS 16025E02	●	23	25	20	35	60	95	2	0,2
16030E03	●	28	30	20	35	60	95	3	0,3
16030E04	●	28	30	20	35	60	95	4	0,3
16032E03	●	30	32	20	35	60	95	3	0,3
16032E04	●	30	32	20	35	60	95	4	0,3
16040E04	●	38	40	20	40	60	100	4	0,4
16040E06	●	38	40	20	40	60	100	6	0,5
16050E04	○	48	50	32	40	80	120	4	1,0
16050E06	●	48	50	32	40	80	120	6	1,0
16050E09	●	48	50	32	40	80	120	9	1,0

Blades are sold separately. If using a blade for corner radius machining (ANB1604R/ANB1608R), DC = DCX.  
The weight includes the weight of the blade and parts.

## ■ Identification Details

<b>ANX</b>	<b>S</b>	<b>16</b>	<b>032</b>	<b>E</b>	<b>04</b>
Cutter Series	Steel Body	Blade Size	Cutter Diameter	Round Shank	Number of Teeth



## Blades

Dimensions (mm)

Application	SUMIDIA	CVD						
High Speed / Light Cut	<b>N</b>	<b>N</b>	<b>N</b>					
General Purpose	<b>N</b>	<b>N</b>	<b>N</b>					
Roughing	<b>N</b>	<b>N</b>	<b>N</b>					
Cat. No.	DA1000	DA90	SCV10	Cutting Edge Length	RE	Wiper Edge Shape	Applications	Fig.
ANB 1600R-L	●	—	—	6,0	—	Linear	Low Cutting Force	1
1600R-G	●	—	—	6,0	—	Arc-Shaped	General Purpose	1
1600R-GB	●	●	—	6,0	—	Arc-Shaped	Combined Milling*	1
1600R-H	●	—	—	6,0	—	Arc-Shaped	Strong Edge	1
1600R-GX	○	—	—	9,0	—	Arc-Shaped	Long Edge	2
1604R	○	—	—	6,0	0,4	Linear	Corner Radius	3
1608R	○	—	—	6,0	0,8	Linear	Corner Radius	3
1600R-W	○	—	—	2,0	—	Arc-Shaped	Wiper	4
1600R-WS	—	—	□	—	—	Arc-Shaped	Wiper	5

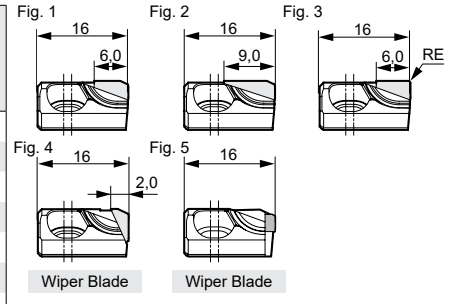

\* Cast Iron/Aluminum Alloy

## Recommended Cutting Conditions

Si content ≤ 12,6 %

Min. - Optimum - Max.

ISO	Work Material	Hardness	Cutting Speed $v_c$ (m/min)	Feed Rate $f_z$ (mm/t)	Grade
<b>N</b>	Aluminum Alloy	—	2.000–2.500–3.000	0,05–0,13–0,20	DA1000

Si content > 12,6 %

Min. - Optimum - Max.

ISO	Work Material	Hardness	Cutting Speed $v_c$ (m/min)	Feed Rate $f_z$ (mm/t)	Grade
<b>N</b>	Aluminum Alloy	—	400–600–800	0,05–0,13–0,20	DA1000 DA90

Combined Milling of Cast Iron/Aluminum Alloy

Min. - Optimum - Max.

ISO	Work Material	Hardness	Cutting Speed $v_c$ (m/min)	Feed Rate $f_z$ (mm/t)	Grade
<b>K</b> <b>N</b>	Cast Iron/ Aluminum Alloy	—	300–400–500	0,05–0,13–0,20	DA90

The above recommended cutting conditions are meant as a guide. Actual conditions will depend on the individual machine rigidity, work clamp rigidity, depth of cut and other factors.

## Max. Allowable Spindle Speed

Cat. No.	n max (min <sup>-1</sup> )
ANXS 16025E02	10.000
16030E03	10.000
16030E04	10.000
16032E03	10.000
16032E04	10.000
16040E04	10.000
16040E06	10.000
16050E04	10.000
16050E06	10.000
16050E09	10.000

## Spare Parts

Sold separately.

Applicable Cutters	Clamp Screw		Adjustment Screw	Wrench	Adjustment Wrench	Assembly Wrench
ANXS 160__E__	BXA0310IP	2,0	HFJ	TRXW10IP	ANT	HFVT

The adjustment spanner (ANT) can also be used for height adjustment of the RF type cutters for high speed machining and the HF type cutters for high efficiency machining.

### Wiper Blade Step Amount

Type: L, G, GX, H

When using the wiper blade, in order to maintain balance, be sure to use a cutter with an even number of cutting edges and place the wiper blades at opposite positions.

# Alnex ANXS 16000 M

**New**

Modular Type

Rake Angle	Radial	-2 - 0°	3 mm	90°
	Axial	+5°		

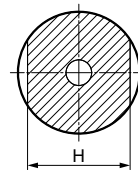
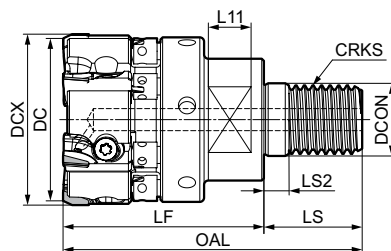
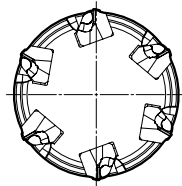

## ■ Body - ANXS (Steel)

Dimensions (mm)

Cat. No.	Stock	DC	DCX	DCON	CRKS	OAL	LF	LS2	LS	L11	H	No. of Teeth	Weight (kg)
ANXS 16025M12Z02	○	23	25	12,5	<b>M12</b>	61	40	5	21	10	19	2	0,1
16030M16Z03	○	28	30	17,0	<b>M16</b>	70	47	5	23	10	24	3	0,2
16030M16Z04	○	28	30	17,0	<b>M16</b>	70	47	5	23	10	24	4	0,2
16032M16Z03	○	30	32	17,0	<b>M16</b>	70	47	5	23	10	24	3	0,3
16032M16Z04	○	30	32	17,0	<b>M16</b>	70	47	5	23	10	24	4	0,3
16040M16Z04	○	38	40	17,0	<b>M16</b>	70	47	5	23	10	24	4	0,4
16040M16Z06	○	38	40	17,0	<b>M16</b>	70	47	5	23	10	24	6	0,4

Blades are sold separately. If using a blade for corner radius machining (ANB1604R/ANB1608R), DC = DCX.  
The weight includes the weight of the blade and parts.

## ■ Identification Details

**ANX S 16 032 M16 Z03**

Cutter Series	Steel Body	Blade Size	Cutter Diameter	Screw size	Number of Blades
---------------	------------	------------	-----------------	------------	------------------

## Blades

Dimensions (mm)

Application	SUMIDIA	CVD						
High Speed / Light Cut	<b>N</b>	<b>N</b>	<b>N</b>					
General Purpose	<b>N</b>	<b>N</b>	<b>N</b>					
Roughing	<b>N</b>	<b>N</b>	<b>N</b>					
Cat. No.	DA1000	DA90	SCV10	Cutting Edge Length	RE	Wiper Edge Shape	Applications	Fig.
ANB 1600R-L	●	—	—	6,0	—	Linear	Low Cutting Force	1
1600R-G	●	—	—	6,0	—	Arc-Shaped	General Purpose	1
1600R-GB	●	●	—	6,0	—	Arc-Shaped	Combined Milling*	1
1600R-H	●	—	—	6,0	—	Arc-Shaped	Strong Edge	1
1600R-GX	○	—	—	9,0	—	Arc-Shaped	Long Edge	2
1604R	○	—	—	6,0	0,4	Linear	Corner Radius	3
1608R	○	—	—	6,0	0,8	Linear	Corner Radius	3
1600R-W	○	—	—	2,0	—	Arc-Shaped	Wiper	4
1600R-WS	—	—	□	—	—	Arc-Shaped	Wiper	5

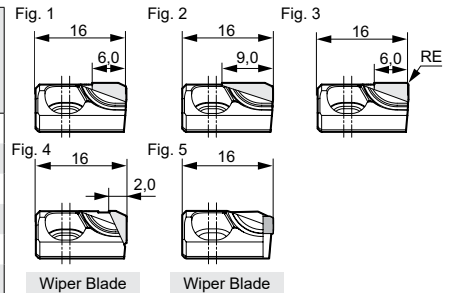

\* Cast Iron/Aluminum Alloy

## Recommended Cutting Conditions

Si content ≤ 12,6 %

Min. - Optimum - Max.

ISO	Work Material	Hardness	Cutting Speed $v_c$ (m/min)	Feed Rate $f_z$ (mm/t)	Grade
<b>N</b>	Aluminum Alloy	—	2.000–2.500–3.000	0,05–0,13–0,20	DA1000

Si content > 12,6 %

Min. - Optimum - Max.

ISO	Work Material	Hardness	Cutting Speed $v_c$ (m/min)	Feed Rate $f_z$ (mm/t)	Grade
<b>N</b>	Aluminum Alloy	—	400–600–800	0,05–0,13–0,20	DA1000 DA90

Combined Milling of Cast Iron/Aluminum Alloy

Min. - Optimum - Max.

ISO	Work Material	Hardness	Cutting Speed $v_c$ (m/min)	Feed Rate $f_z$ (mm/t)	Grade
<b>K</b> <b>N</b>	Cast Iron/ Aluminum Alloy	—	300–400–500	0,05–0,13–0,20	DA90

The above recommended cutting conditions are meant as a guide. Actual conditions will depend on the individual machine rigidity, work clamp rigidity, depth of cut and other factors.

## Max. Allowable Spindle Speed

Cat. No.	n max (min <sup>-1</sup> )
ANXS 16025M12Z02	10.000
16030M16Z03	10.000
16030M16Z04	10.000
16032M16Z03	10.000
16032M16Z04	10.000
16040M16Z04	10.000
16040M16Z06	10.000

## Spare Parts

Sold separately.

Applicable Cutters	Clamp Screw		Adjustment Screw	Wrench	Adjustment Wrench	Assembly Wrench
ANXS160__M_Z__	BXA0310IP	2,0	HFJ	TRXW10IP	ANT	HFVT

The adjustment spanner (ANT) can also be used for height adjustment of the RF type cutters for high speed machining and the HF type cutters for high efficiency machining.

## Wiper Blade Step Amount

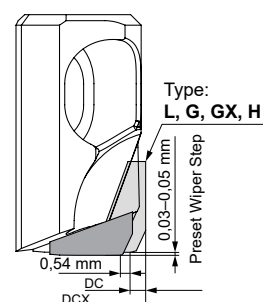

When using the wiper blade, in order to maintain balance, be sure to use a cutter with an even number of cutting edges and place the wiper blades at opposite positions.

# SUMIDIA Face Mill RF Type

## High Speed Finishing of Aluminium Alloy



Fig. 1

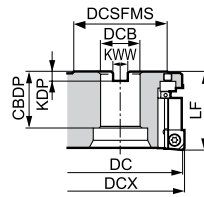
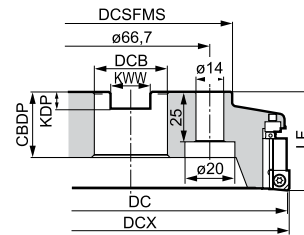

Fig. 2



### Body

Cat. No.	Stock	Dimensions (mm)								Number of teeth	max. depth of cut	Weight (Kg)	Fig.
		DC	DCX	DCSFMS	LF	DCB	KWW	KDP	CBDP				
RF 4080 RS	●	80	82	60	50	27	12,4	7,0	29	6	3,0	0,7	1
RF 4100 RS	□	100	102	75	50	32	14,4	8,5	29	6		1,0	1
4125 RS	●	125	127	75	63	40	16,4	9,5	29	8		1,6	1
4160 RS	□	160	162	100	63	40	16,4	9,5	29	10		2,6	2

Remark: PCD blades and inserts are not included.

### Insert for Roughing and Finishing

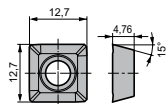

Fig. 1

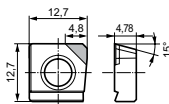

Fig. 2

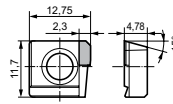
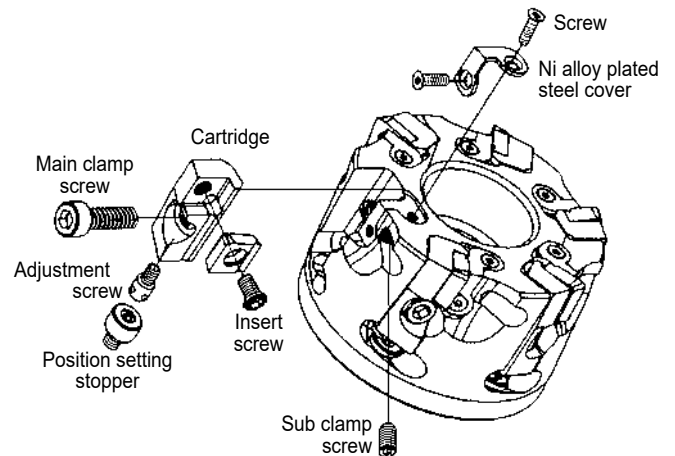

Fig. 3

Application	Carbide	SUMIDIA		
High Speed / Light cut	N	N	N	
General Purpose	N	N	N	
Roughing	N	N	N	
Cat. No.	H1	DA1000	DA2200	Fig.
SDET 1204 ZDFR	●			1
SNEW 1204 ADFR-NF		●	▲	2
SNEW 1204 ADFR-W-NF		●	▲	3

### Structure



### "Sumidia" Blade

PCD grade DA2200	Cat. No.	Stock
Standard type	RFB	▲
Wiper type	RFBW	▲

### Dummy Blade

	RFD	○
--	-----	---

### Cartridge

Shape	Cat. No.	Stock
For carbide insert	RFR	●
For Sumidia insert	RFF	●

### Cutting Insert Selection

For easy assembling:

PCD blade RFB  
PCD blade RFB (wiper type)

For finishing:

Cartridge RFF  
PCD insert SNEW 1204 ADFR-NF (standard type)  
SNEW 1204 ADFR-W-NF (wiper type)  
PCD grade: DA2200

For roughing:

Cartridge RFR  
Uncoated carbide insert  
SDET 1204 ZDFR, grade: H1

### Spare Parts

RFC	RFS	BX0620	BTD0510	FBUP2-A0-8	RFJ	BFTX0509N	TH050 TH015, TH025 TH050	TTX20

### Setting Gauge



Dial-gauge is not included.

● = Euro stock  
○ = Japan stock

□ = Delivery on request  
▲ = To be replaced by new item

# SUMIDIA Face Mill SRF Type

## High Speed Finishing of Aluminium Alloy



Fig. 1

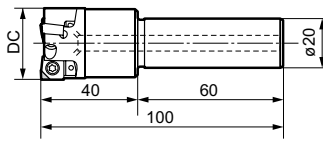
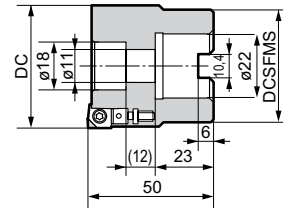

Fig. 2



### Body

Cat. No.	Stock	Dimensions (mm)		No. of teeth	Fig.	Weight (Kg)
		DC	DCSFMS			
SRF 30 R-ST	○	30	-	3	1	0,34
SRF 40 R-ST	○	40	-	4	1	0,50
SRF 50 RS	□	50	46,5	5	2	0,59
SRF 63 RS	□	63	45,0	6	2	0,67

Inserts are sold separately.

### Insert

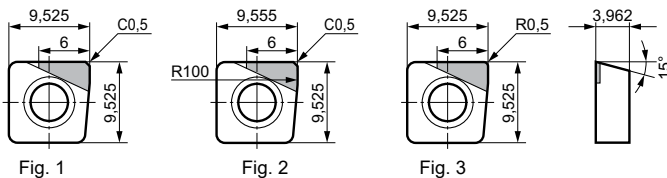

### Spare Parts

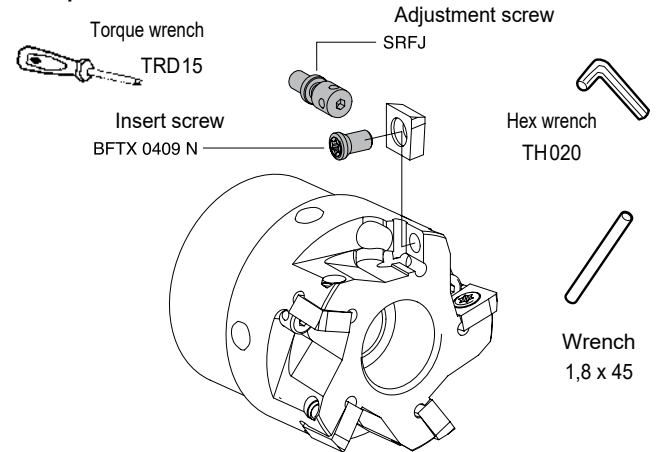

### Maximum D.O.C. Guide (SRF50RS, 5 teeth)

The contains guidelines on the maximum D.O.C., determined from internal tests. "O" mark indicates the possible application range. Actual cutting conditions should be set, based on actual machine and work characteristics.

Feed	Feed Speed, $v_f$ (mm/min)		
	2.500	4.000	5.000
	Feed Rate, $f_z$ (mm/tooth)		
D.O.C. (mm)	0,05	0,08	0,10
0,5	○	○	○
1,0	○	○	○
1,5	○	○	○
2,0	○	○	○
2,5	○	○	○
3,0	○	○	○
3,5	○	○	-
4,0	○	-	-
4,5	○	-	-
5,0	○	-	-

### Cutting Conditions

Cutter: SRF 50 RS  
 Insert: SNEW 09T3 ADFR-NF (DA1000)  
 n : 10.000 rpm  
 Width: 35 mm at D.O.C. indicated above

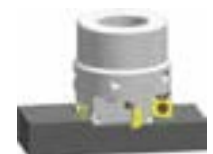

Application	SUMIDIA
High Speed / Light cut	N
General Purpose	N
Roughing	N

Cat. No.	DA1000	Cutting Edge	Fig.
SNEW 09T3 ADTR-NF	□	Standard	1
09T3 ADTR-U-NF	□	Wiper	2
09T3 ADTR-R-NF	○	Nose Radius	3

- Standard inserts and Wiper inserts can be used on the same cutter body.
- Standard inserts with nose radius should be used where vibration is present. As such, Wiper-inserts will not be applicable.
- Inserts can be regrind 3 times (up to minimum IC diameter 9,225 mm).
- When using reground inserts, it is advisable to reconfirm insert height and cutting diameter with a tool pre-setter.
- Do not mix new and reground inserts, or even inserts with different regrind amount on the same cutter.

### Recommended Cutting Conditions for RF and SRF Type Cutters

Work Material	Process	Grade	Cutting Speed (m/min)		Feed Rate (mm/tooth)	Depth of Cut (mm)		
			RF Type	SRF Type		RF Type	SRF Type	
Aluminium Alloy	Si < 13 %	Finishing	DA1000 (PCD)	2.000-5.000	- 4.000	0,05-0,2	- 3,0	- 5,0
		Roughing	H1 (Carbide)	1.000-2.500	-			
	Si ≥ 13 %	Finishing	DA1000 (PCD)	400-800	- 800			
		Roughing	H1 (Carbide)	200-400	-			



# SUMIBORON "BN Finish Mill" FMU Type

## High Speed Finishing of Grey Cast Iron



### ■ Features

- High speed machining  $v_c = 1.500$  m/min
- Excellent surface roughness  $R_z = 3,2$  ( $R_a = 1,0$ )
- Safety structure for the centrifugal force under high speed cutting conditions
- Run-out is less than  $10 \mu\text{m}$
- Easy assembling method using the setting gauge
- Running cost is reduced because of economical insert

### ■ Application

GG25 – GG30 (HB200 – 250) grey cast iron with pearlite matrix, and ferrite matrix (HB130 – 160)  
Application examples: engine block, cylinder block, etc

### ■ Specifications

FMU Type:  $\varnothing 80$ – $\varnothing 315$  mm  
Insert: SNEW1203ADTR/L  
Low cutting force type: SNEW1203ADTR/L-S

### ■ Recommended Cutting Conditions

Speed:  $v_c = 800$ – $2000$  m/min  
Feed:  $f_z = 0,1$ – $0,3$  mm/tooth  
Depth:  $a_p = 0,5$  mm or less  
Dry cutting



### ■ Performance

#### ● Tool Life Diagram

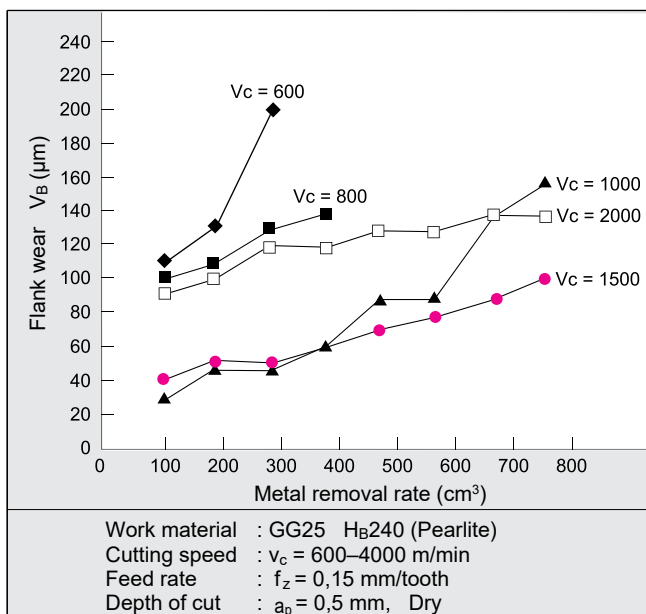

#### ● Estimated Tool Life

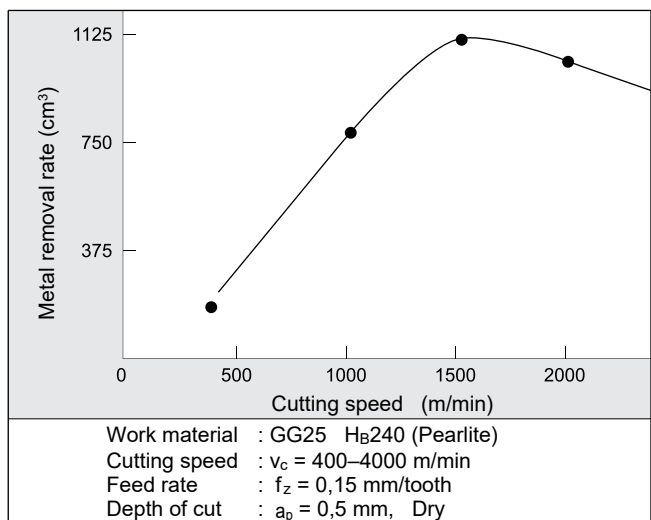

- Milling of ductile cast iron and alloy steel casting do not produce the best results.
- Dry cutting is recommended. Wet cutting will result in chipping of cutting edges in the early stages due to thermal cracking.

# SUMIBORON "BN Finish Mill" FMU Type

## Specifications

Approach angle: 90°  
Axial rake angle: + 8°  
Radial rake angle: + 2°

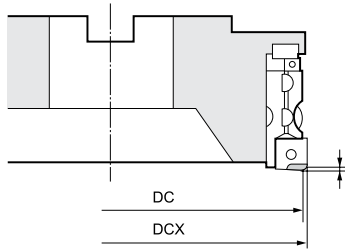

Max. depth of cut: 0,5 mm

## Structure

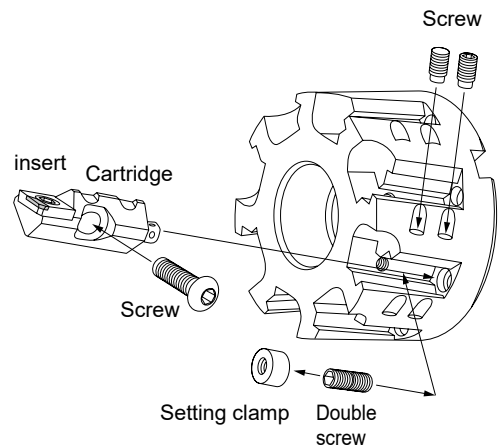

## Body

Fig. 1

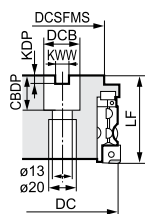

Fig. 2

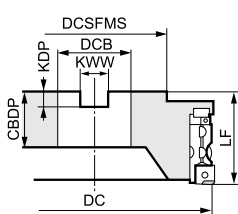

Fig. 3

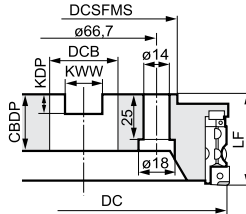

Fig. 4

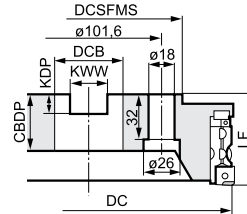
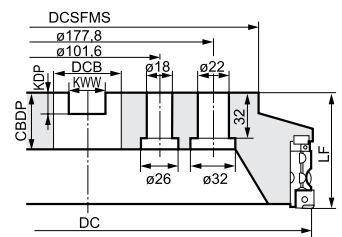

Fig. 5



Cat. No.	Stock	Dimensions (mm)									No. of Teeth	Max. Depth of Cut	Weight (Kg)	Fig.
		DC	DCX	DCSFMS	LF	DCB	KWW	KDP	CBDP					
FMU 4080 RS	□	80	82,8	60	63	27	12,4	7,0	25	6	0,5	1,6	1	
FMU 4100 RS	●	100	102,8	76	63	32	14,4	8,5	29	8		2,4	2	
4125 RS	□	125	127,8	75	63	40	16,4	9,5	29	10		3,4	2	
4160 RS	□	160	162,8	100	63	40	16,4	9,5	29	12		5,6	3	
FMU 4200 RS	□	200	202,8	130	63	60	25,7	14,0	38	16		9,2	4	
4250 RS	□	250	252,8	130	63	60	25,7	14,0	38	20	14,3	4		
FMU 4315 RS		315	317,8	240	80	60	25,7	14,0	40	24	27,8	5		

## Inserts

Fig. 1

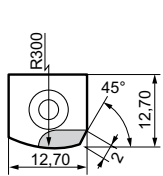
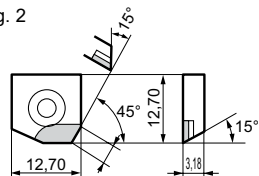

Fig. 2



Application	CBN		Figure
High Speed / Light cut	K	K	
General Purpose	K	K	
Roughing			
Cat. No.	BN700	BN7000	
SNEW 1203 ADT R	▲	○	1
1203 ADT R-S	▲	○	2

## Cartridge

Cartridge	Insert Screw	Adjustment Screw	O-ring	Insert Wrench	Pin
FMUU	BFTX0509N	FMUJ	P3	TRX20	1,8 x 45

## Spare Parts

Screw	Screw	Setting clamp	Double screw	Wrench	Wrench	Wrench
BH0620	BTD0609	FMUE	WB5-10	TH040	LH030	LH025

## Gauge

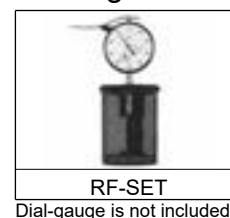

# SUMIBORON "Helical Master" BNES Type

## Spiral CBN Endmill for Hardened Steel

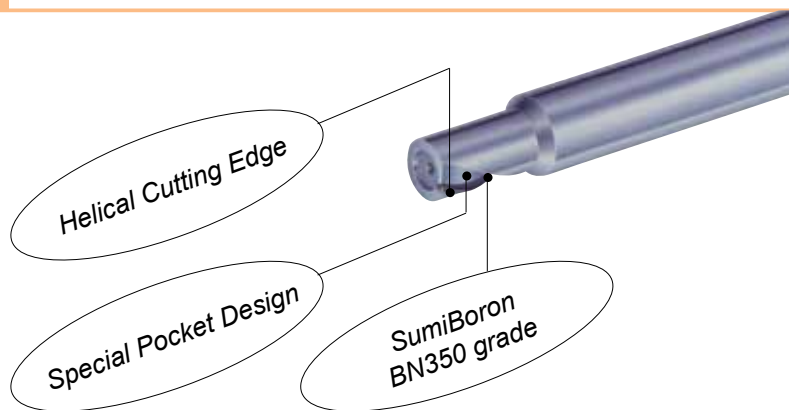

### Endmills BNES Type with 1 Spiral Flute

	Cat. No.	Stock	Dimensions (mm)				
		BN350	DC	DMM	APMX	LU	LF
	BNES 1060	○	6,0	10	7,0	11	60
	BNES 1080	○	8,0	10	10,0	14	70
	BNES 1100	○	10,0	12	12,0	17	75
	BNES 1120	○	12,0	12	14,0	20	80
	BNES 1140	○	14,0	16	16,0	21,5	80

Helix angle : 15°  
right-hand cut, right-hand helix

### Recommended Cutting Conditions

Cutting speed:  $v_c$  (m/min), Spindle revolutions:  $n$  (rpm), Feed per tooth:  $f_z$  (mm/tooth), Feed speed:  $v_f$  (mm/min)

Tooling example	DC	Hardened steel (HRC 50–57)			Hardened steel (HRC 58–65)		
		$v_c = 100\text{--}170$ m/min			$v_c = 80\text{--}150$ m/min		
<p>Depth of cut : <math>a_p \leq DC</math></p>	$\phi 6\text{--}8$	$a_e \leq 0,1$ mm	$n = 4000\text{--}9000$	$V_f$ (mm/min) = 240–540	$a_e \leq 0,08$ mm	$n = 3200\text{--}8000$	$V_f$ (mm/min) = 150–370
	$\phi 10\text{--}12$	$a_e \leq 0,15$ mm	$n = 2700\text{--}5400$	$V_f$ (mm/min) = 180–360	$a_e \leq 0,12$ mm	$n = 2100\text{--}4800$	$V_f$ (mm/min) = 120–270
	$\phi 14\text{--}16$	$a_e \leq 0,2$ mm	$n = 2000\text{--}3800$	$V_f$ (mm/min) = 140–260	$a_e \leq 0,15$ mm	$n = 1600\text{--}3400$	$V_f$ (mm/min) = 110–230

Recommendation: Dry cutting (Air coolant)  
Down-cut milling  
Minimise the overhang  
Use a rigid machine

### Performance

#### Long Tool Life and High Efficiency

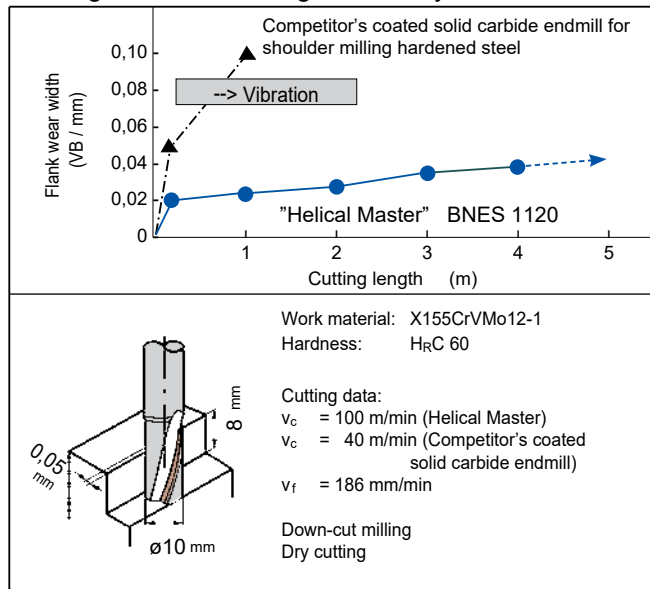

#### Excellent Surface Roughness

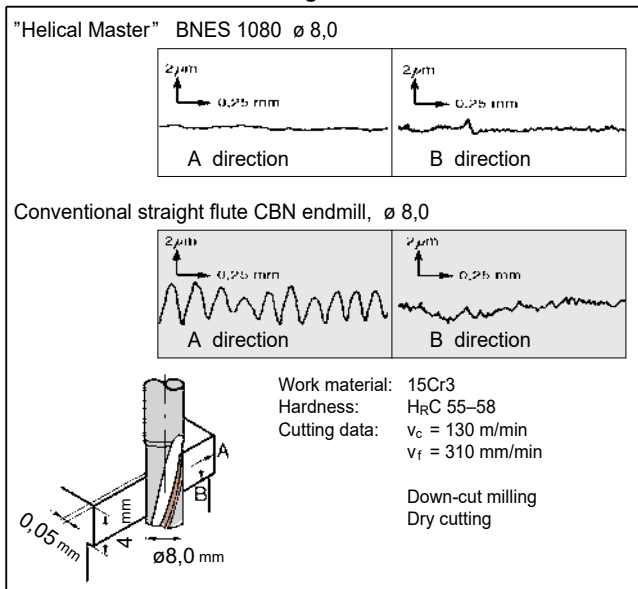

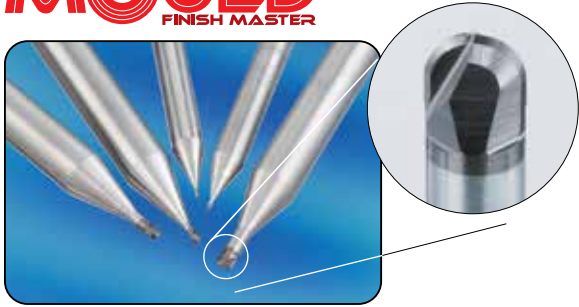

■ Characteristics / Application

- High precision machining of hardened steels < HRC 70 with long tool life
- Super tough grade SUMIBORON BN350 prevents chipping of the cutting edge
- R accuracy : ±0,005 mm

■ Endmills

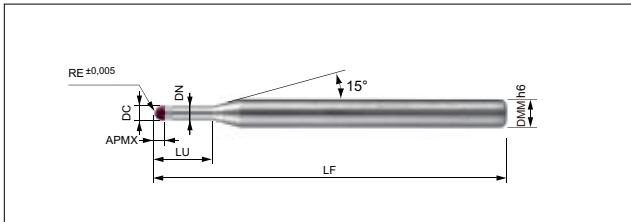

■ Identification Details

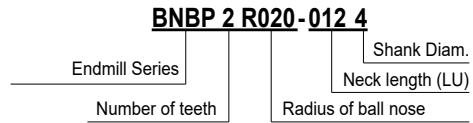

Dimensions (mm)

Cat. No.	Stock	RE	DC	APMX	LU	LF	DN	DMM
BNBP 2R0200124	●	0,20	0,4	0,3	1,2	50	0,37	4
2R0200126	●	0,20	0,4	0,3	1,2	50	0,37	6
2R0200204	○	0,20	0,4	0,3	2,0	50	0,37	4
2R0200304	○	0,20	0,4	0,3	3,0	50	0,37	4
2R0200404	○	0,20	0,4	0,3	4,0	50	0,37	4
BNBP 2R0300154	●	0,30	0,6	0,4	1,5	50	0,57	4
2R0300156	●	0,30	0,6	0,4	1,5	50	0,57	6
2R0300304	○	0,30	0,6	0,4	3,0	50	0,57	4
2R0300404	○	0,30	0,6	0,4	4,0	50	0,57	4
2R0300504	○	0,30	0,6	0,4	5,0	50	0,57	4
2R0300604	○	0,30	0,6	0,4	0,6	50	0,57	4
BNBP 2R0500254	●	0,50	1,0	0,6	2,5	50	0,97	4
2R0500256	●	0,50	1,0	0,6	2,5	50	0,97	6
2R0500304	○	0,50	1,0	0,6	3,0	50	0,97	4
2R0500404	○	0,50	1,0	0,6	4,0	50	0,97	4
2R0500604	○	0,50	1,0	0,6	0,6	50	0,97	4
2R0500804	○	0,50	1,0	0,6	8,0	50	0,97	4
BNBP 2R0750404	○	0,75	1,5	0,9	4,0	50	1,47	4
2R0750406	●	0,75	1,5	0,9	4,0	50	1,47	6
BNBP 2R1000554	●	1,00	2,0	1,4	5,5	50	1,97	4
2R1000556	●	1,00	2,0	1,4	5,5	50	1,97	6
2R1000804	○	1,00	2,0	1,4	8,0	50	1,97	4

Grade: BN350

■ Recommended Cutting Conditions

Work Material	STAVAX, NAK80, SKD61 (< 52HRC)					ELMAX, DC53, SKD11 (< 62HRC)				YXR3, SKH (< 70HRC)			
	RE (mm)	LU (mm)	Spindle Speed (min <sup>-1</sup> )	Feed Rate (mm/min)	ap (mm)	pf (mm)	Spindle Speed (min <sup>-1</sup> )	Feed Rate (mm/min)	ap (mm)	pf (mm)	Spindle Speed (min <sup>-1</sup> )	Feed Rate (mm/min)	ap (mm)
0,2	1,2	40.000	1.000	0,005	0,010	40.000	800	0,005	0,010	40.000	600	0,005	0,005
	2,0	40.000	800	0,005	0,010	40.000	600	0,005	0,010	40.000	400	0,005	0,005
	3,0	40.000	600	0,005	0,010	40.000	500	0,005	0,010	40.000	300	0,005	0,005
	4,0	40.000	500	0,005	0,010	40.000	400	0,005	0,005	40.000	200	0,005	0,005
0,3	1,5	40.000	1.600	0,020	0,020	40.000	1.400	0,010	0,020	40.000	1.200	0,010	0,020
	2,0	40.000	1.500	0,010	0,020	40.000	1.300	0,010	0,020	40.000	1.100	0,010	0,010
	3,0	40.000	1.400	0,010	0,020	40.000	1.200	0,010	0,020	40.000	1.000	0,010	0,010
	4,0	30.000	1.200	0,010	0,010	30.000	1.000	0,010	0,010	30.000	700	0,005	0,010
	5,0	30.000	800	0,010	0,010	30.000	700	0,005	0,010	30.000	600	0,005	0,005
0,5	2,5	40.000	2.800	0,040	0,050	40.000	2.800	0,030	0,040	40.000	2.200	0,020	0,030
	3,0	40.000	2.600	0,040	0,050	40.000	2.600	0,030	0,040	40.000	2.100	0,020	0,030
	4,0	40.000	2.400	0,030	0,050	40.000	2.400	0,020	0,030	40.000	2.000	0,020	0,020
	6,0	25.000	1.500	0,020	0,030	25.000	1.500	0,010	0,020	25.000	1.300	0,010	0,010
	8,0	16.000	1.200	0,020	0,020	16.000	1.100	0,010	0,020	16.000	850	0,010	0,010
0,75	4,0	32.000	2.400	0,030	0,030	32.000	2.200	0,020	0,030	32.000	2.000	0,020	0,020
	1,0	5,5	40.000	4.000	0,050	0,050	40.000	4.000	0,030	0,030	40.000	3.000	0,020
1,0	8,0	32.000	3.000	0,030	0,050	32.000	2.600	0,020	0,030	32.000	2.200	0,010	0,020

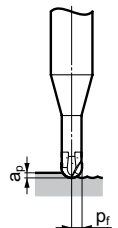

Important Notes

- (1) For stable machining, a more rigid machine is recommended.
- (2) Air blast or oil mist coolant is recommended.
- (3) Shorten overhang as much as possible.

# SUMIDIA "MOULD Finish Master" NPDRS Type

## SUMIDIA Binderless Radius Endmill NPDRS Type

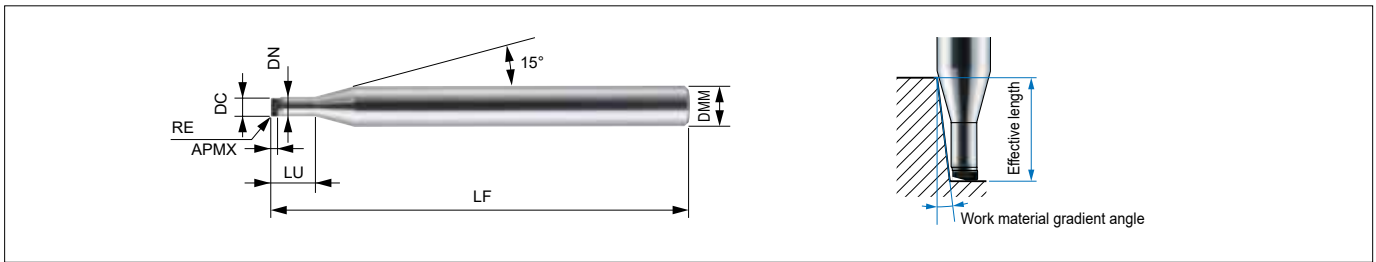

### NPDRS Type Body (for Standard Finishing)

Cat. No.	Stock	Dimensions (mm)							Real effective length with respect to work material gradient angle				
	NPD10	DC	RE	APMX	LU	LF	DN	DMM	0,5°	1°	1,5°	2°	3°
NPDRS 1020 R002-006	○	0,2	0,02	0,10	0,6	40	0,175	4	0,61	0,62	0,63	0,64	0,66
1020 R005-006	○	0,2	0,05	0,10	0,6	40	0,175	4	0,61	0,62	0,63	0,64	0,66
1030 R002-010	○	0,3	0,02	0,15	1,0	40	0,27	4	1,01	1,03	1,04	1,06	1,09
1030 R005-010	○	0,3	0,05	0,15	1,0	40	0,27	4	1,01	1,03	1,04	1,06	1,09
1050 R005-015	○	0,5	0,05	0,25	1,5	40	0,47	4	1,61	1,66	1,72	1,78	1,92
NPDRS 1050 R010-015	○	0,5	0,10	0,25	1,5	40	0,47	4	1,61	1,66	1,71	1,77	1,91
1100 R005-030	○	1,0	0,05	0,55	3,0	40	0,95	4	3,40	3,52	3,65	3,78	4,08
1100 R010-030	○	1,0	0,10	0,55	3,0	40	0,95	4	3,40	3,52	3,64	3,77	4,07
1100 R020-030	○	1,0	0,20	0,55	3,0	40	0,95	4	3,40	3,51	3,63	3,76	4,05
1200 R005-040	○	2,0	0,05	0,55	4,0	40	1,95	4	4,44	4,59	4,75	4,93	5,33
NPDRS 1200 R010-040	○	2,0	0,10	0,55	4,0	40	1,95	4	4,43	4,59	4,75	4,92	5,31
1200 R020-040	○	2,0	0,20	0,55	4,0	40	1,95	4	4,43	4,58	4,74	4,91	5,29

### Identification Details

**NPDR**      **S**      **1**      **020**      **R002** - **006**  
 Series Code      For standard finishing      No. of flutes      Cutting diameter      Corner radius      Length below neck

### Cutting Diameter and Nose Radius Combinations

DC	RE 0,02	RE 0,05	RE 0,1	RE 0,2
0,2	○	○		
0,3	○	○		
0,5		○	○	
1,0		○	○	○
2,0		○	○	○

### Recommended Cutting Conditions

- Use a machine with high rigidity for stable cutting.
- Non-water soluble coolant recommended. Supply as a mist or external coolant. Take fire prevention precautions to avoid fire hazards caused by sparks igniting during machining or tool breakage.
- Shorten overhang as much as possible.
- Adjust cutting conditions as necessary as machine rigidity and other conditions may vary.
- Depth of cut shown in the table of conditions are maximum depths. Adjust the actual depth of cut to the desired machined surface finish.

Work Material		Carbide				
RE (mm)	LU	Spindle Speed (min <sup>-1</sup> )	Feed Rate (mm/min)	a <sub>p</sub> (mm)	a <sub>e</sub> (mm)	
0,2	0,10	40.000	100	0,001	0,001	
0,3	0,15	40.000	150	0,002	0,001	
0,5	0,25	40.000	200	0,003	0,001	
1,0	0,55	40.000	400	0,005	0,003	
2,0	0,55	40.000	600	0,010	0,005	



○ = Japan stock



## SUMIDIA Binderless Ballnose Endmill NPDBS Type / NPDB Type

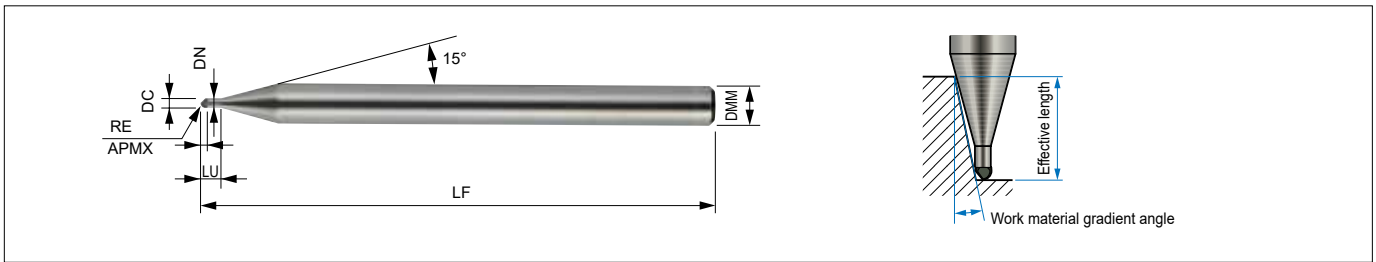

### NPDBS Type Body (for Standard Finishing)

Cat. No.	Stock NPD10	Dimensions (mm)							Real effective length with respect to work material gradient angle				
		RE	DC	APMX	LU	LF	DN	DMM	0,5°	1°	1,5°	2°	3°
NPDBS 1010-004	○	0,1	0,2	0,1	0,4	40	0,18	4	0,44	0,45	0,46	0,47	0,49
1020-008	○	0,2	0,4	0,2	0,8	40	0,38	4	0,83	0,84	0,85	0,86	0,89
1030-010	○	0,3	0,6	0,3	1,0	40	0,58	4	1,05	1,08	1,10	1,13	1,20
1050-020	○	0,5	1,0	0,5	2,0	40	0,95	4	2,08	2,13	2,19	2,24	2,38
1100-030	○	1,0	2,0	1,0	3,0	40	1,95	4	3,13	3,20	3,27	3,35	3,53

### NPDB Type Body (for Precision Finishing)

Cat. No.	Stock NPD10	Dimensions (mm)							Real effective length with respect to work material gradient angle				
		RE	DC	APMX	LU	LF	DN	DMM	0,5°	1°	1,5°	2°	3°
NPDB 1010-004	○	0,1	0,2	0,1	0,4	40	0,18	4	0,44	0,45	0,46	0,47	0,49
1020-008	○	0,2	0,4	0,2	0,8	40	0,38	4	0,83	0,84	0,85	0,86	0,89
1030-010	○	0,3	0,6	0,3	1,0	40	0,58	4	1,05	1,08	1,10	1,13	1,20
1050-020	○	0,5	1,0	0,5	2,0	40	0,95	4	2,08	2,13	2,19	2,24	2,38
1100-030	○	1,0	2,0	1,0	3,0	40	1,95	4	3,13	3,20	3,27	3,35	3,53

### Identification Details

**NPDB**     **(S)**     **1**     **030**     -     **010**  
 Series Code     For standard finishing     No. of flutes     Ballnose radius     Length below neck

### Recommended Cutting Conditions

- Use a machine with high rigidity for stable cutting.
- Non-water soluble coolant recommended. Supply as a mist or external coolant.  
Take fire prevention precautions to avoid fire hazards caused by sparks igniting during machining or tool breakage.
- Shorten overhang as much as possible.
- Adjust cutting conditions as necessary as machine rigidity and other conditions may vary.
- Depth of cut shown in the table of conditions are maximum depths. Adjust the actual depth of cut to the desired machined surface finish.

#### ● Flat Surface Finishing

Work Material		Carbide			
RE (mm)	LU	Spindle Speed (min <sup>-1</sup> )	Feed Rate (mm/min)	a <sub>p</sub> (mm)	a <sub>e</sub> (mm)
0,1	0,4	40.000	100	0,001	0,001
0,2	0,8	40.000	150	0,001	0,001
0,3	1,0	40.000	200	0,001	0,001
0,5	2,0	40.000	400	0,001	0,003
1,0	3,0	40.000	600	0,001	0,005

#### ● Copy Finishing

Work Material		Carbide			
RE (mm)	LU	Spindle Speed (min <sup>-1</sup> )	Feed Rate (mm/min)	a <sub>p</sub> (mm)	a <sub>e</sub> (mm)
0,1	0,4	40.000	100	0,001	0,001
0,2	0,8	40.000	150	0,002	0,001
0,3	1,0	40.000	200	0,003	0,001
0,5	2,0	40.000	400	0,005	0,003
1,0	3,0	40.000	600	0,010	0,005

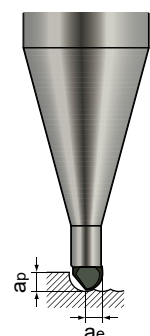



# SUMIDIA Drills

## DAL/DDL/DML Type



From general to High Precision Drilling of Aluminum Alloys!

- High precision DAL type is able to produce holes of IT Class of 7 – 8.
- General DDL type is able to produce holes of IT class of 11 – 12, mainly for drilling of pre-tap holes.
- DML type is DDL type with a chamfer edge, incorporating 2 processes in one operation.

### ■ DAL Type

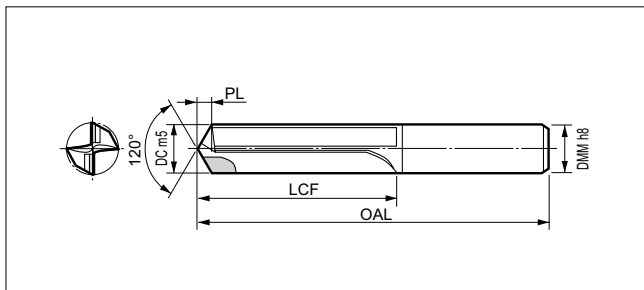

Cat. No.	DA2200	DC (DMM)	LCF	OAL	PL
DAL 0500H – 0600H	☐	$\emptyset 5 \leq DC \leq \emptyset 6$	31,6	84,6	1,6
0601H – 0700H	☐	$\emptyset 6 < DC \leq \emptyset 7$	36,9	91,9	1,9
0701H – 0800H	☐	$\emptyset 7 < DC \leq \emptyset 8$	37,2	92,2	2,2
0801H – 0900H	☐	$\emptyset 8 < DC \leq \emptyset 9$	42,5	102,5	2,5
0901H – 1000H	☐	$\emptyset 9 < DC \leq \emptyset 10$	42,8	102,8	2,8
1001H – 1100H	☐	$\emptyset 10 < DC \leq \emptyset 11$	53,1	113,1	3,1
1101H – 1200H	☐	$\emptyset 11 < DC \leq \emptyset 12$	53,4	113,4	3,4

### ■ DDL Type

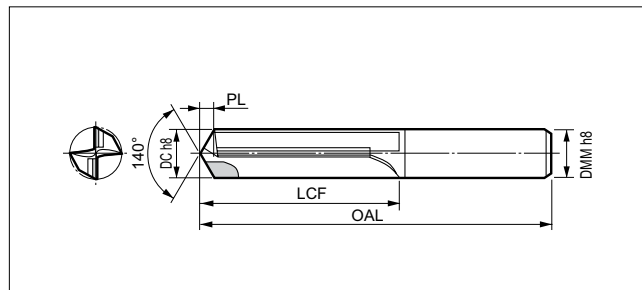

Cat. No.	DA2200	DC (DMM)	LCF	OAL	PL
DDL 050V – 060V	☐	$\emptyset 5 \leq DC \leq \emptyset 6$	31,5	81,0	1,0
061V – 070V	☐	$\emptyset 6 < DC \leq \emptyset 7$	36,2	91,2	1,2
071V – 080V	☐	$\emptyset 7 < DC \leq \emptyset 8$	36,4	91,4	1,4
081V – 090V	☐	$\emptyset 8 < DC \leq \emptyset 9$	41,6	101,6	1,6
091V – 100V	☐	$\emptyset 9 < DC \leq \emptyset 10$	41,7	101,7	1,7
101V – 110V	☐	$\emptyset 10 < DC \leq \emptyset 11$	51,9	111,9	1,9
111V – 120V	☐	$\emptyset 11 < DC \leq \emptyset 12$	52,1	112,1	2,1

### ■ Recommended Conditions

DC (mm)	Cutting Speed (m/min)	Feed Rate (mm/rev)	Drilling Length L/D	Oil
<8	80–250	0,05–0,2	Below 3 x D	Water soluble
$\geq 8 \leq 12$		0,1–0,3		

### ■ Important Notes

- Select a high rigidity machine and high precision tool holder.
- Enough coolant to drilled hole.

### ■ Application Examples (DAL Type)

Work Shape	Work	Conditions	Results
	A390 High silicon Aluminum	$V_c=100\text{m/min}$ $f=0,1\text{mm/rev}$	<ul style="list-style-type: none"> <li>• Holes by carbide drill was out of specifications after 2.000 holes/reg.</li> <li>• SumiDia drill could drill up to 30.000 holes/reg.</li> <li>• 15 times tool life that of carbide drills.</li> </ul>
	A390 High silicon Aluminum (pre-cast hole of $\emptyset 10$ )	$V_c=120\text{m/min}$ $f=0,12\text{mm/rev}$	<ul style="list-style-type: none"> <li>• Average 40,000 holes/reg</li> <li>• Surface roughness <math>R_y = 1 \mu\text{m}</math></li> </ul>
	ADC10 Aluminum Die Cast	$V_c=90\text{m/min}$ $f=0,08\text{mm/rev}$	<ul style="list-style-type: none"> <li>• More than 50.000 holes and still running</li> </ul>

### ■ Application Examples (DDL Type)

Work Shape	Work	Conditions	Results
	ADC12 Aluminum Die Cast M8 Pre-tap holes	$V_c=214\text{m/min}$ $f=0,14\text{mm/rev}$	<ul style="list-style-type: none"> <li>• Regrind after 100.000 holes</li> </ul>
	ADC12 Aluminum Die Cast	$V_c=200\text{m/min}$ $f=0,17 \text{ mm/rev}$	<ul style="list-style-type: none"> <li>• Regrind after 74.000 holes (2.000m) (Preset tool change)</li> </ul>
	AC2A Aluminum Casting	$V_c=234\text{m/min}$ $f=0,28 \text{ mm/rev}$	<ul style="list-style-type: none"> <li>• Regrind after 80.000 holes (Preset tool change)</li> </ul>

☐ = Delivery on request

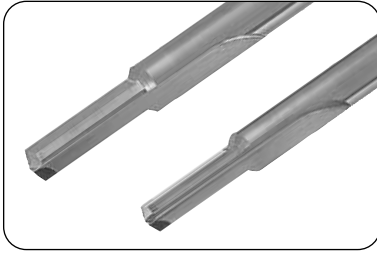

## ■ DML Type

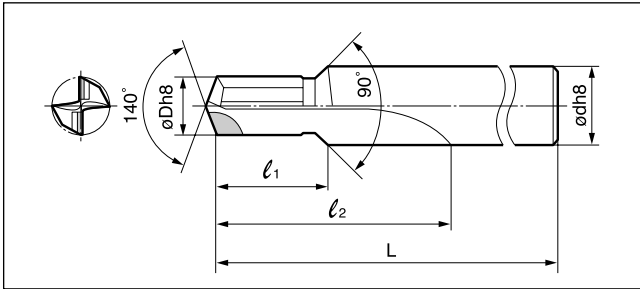

Applicable Tap Size	Cat. No.	Stock	$\phi D$	$\phi d$	L	$l_1$	$l_2$
		DA2200					
M6	DML 050V	□	5	8	90	18	36
M8	DML 068V	□	6,8	10	104	24	48
M10	DML 085V	□	8,5	12	122	30	60
M12	DML 103V	□	10,3	14	136	36	72

## ■ Application Examples (DML Type)

Work Shape	Work	Conditions	Results
	AC4C-T6 Aluminum Casting M6 Pre-tap holes	$V_c=100\text{m/min}$ $f=0,1\text{mm/rev}$ $m/c=6$ spindles	<ul style="list-style-type: none"> <li>• Regrind after 150.000 holes</li> <li>• Tool life for carbide drill is 500 holes.</li> <li>• 30 times tool life that of carbide drills</li> </ul>
	AC2C-T2 Aluminum Casting M8 Pre-tap holes	$V_c=210\text{m/min}$ $f=0,15\text{mm/rev}$	<ul style="list-style-type: none"> <li>• 100.000 holes/reg (2.000m) and still running.</li> <li>• Drilling and chamfering in the same process</li> </ul>
	AC4C-T6 Aluminum Casting M10 Pre-tap holes	$V_c=250\text{m/min}$ $f=0,2\text{mm/rev}$	<ul style="list-style-type: none"> <li>• 80.000 holes/reg (1,840m) and still running.</li> <li>• Drilling and chamfering in the same process</li> </ul>

## ■ DML Type Possible Profiles

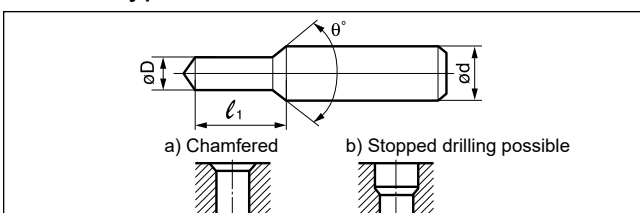

- (1) Tolerance for dimension L is more than 0,2mm.
- (2)  $\theta^\circ$  is less than  $180^\circ$ .



# Technical Guidance References



**N1–N28**

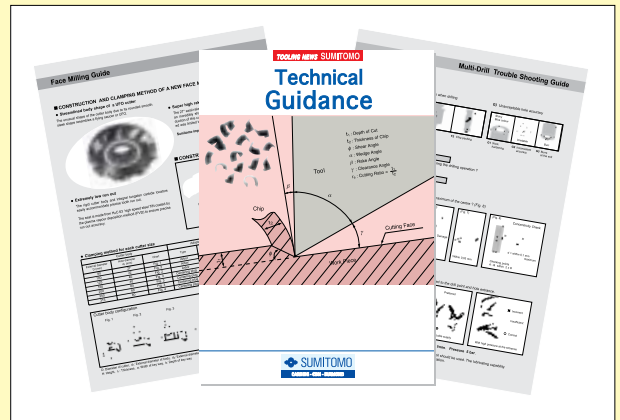

<b>Basics of Turning</b> .....	N2
Tool Failures and Remedies .....	N3–4
Chip Control.....	N5
<b>Basics of Milling</b> .....	N6–8
Tool Failures and Remedies.....	N9
<b>Basics of Endmilling</b> .....	N10–11
Tool Failures and Remedies.....	N12
<b>Basics of Drilling</b> .....	N13–15
Tool Failures and Remedies.....	N16
<b>SUMIBORON for</b>	
Hardened Steel Machining .....	N17
Cast Iron Machining .....	N18
Hard-to cut Materials Machining .....	N19
Tool Failure and Remedies .....	N20
<b>References</b>	
Steel and Non-Ferrous Metal Symbols Chart ....	N21-25
Hardness Scale Comparison Chart.....	N26
Finished Surface Roughness .....	N27

**Expansion**

# Technical Guidance

## Basics of Turning

### Calculating Power Requirement

$P_c = \frac{a_p \cdot f \cdot v_c \cdot K_c}{60 \times 10^3 \times \eta}$	$H = \frac{P_c}{0,75}$	$P_c$ : Net power requirement (KW) $v_c$ : Cutting speed (m/min) $f$ : Feed rate (mm/rev) $a_p$ : Depth of cut (mm) $\eta$ : Machine efficiency (0,70 ~ 0,85) $K_c$ : Specific cutting force (N/mm <sup>2</sup> ) $H$ : Required horsepower (HP)
--	------------------------	--

● Rough value of specific cutting force ( $K_c$ )

General steel :	2.500 ~ 3.000 N/mm <sup>2</sup>
Cast iron :	1.500 N/mm <sup>2</sup>
Aluminum :	800 N/mm <sup>2</sup>

### Cutting Force

$F_1$  : Principal force  
 $F_2$  : Feed force  
 $F_3$  : Back force

● Calculating cutting force

$P = K_c \cdot q$	$P = \frac{K_c \times a_p \times f}{1000}$	$P$ : Cutting force (N) $K_c$ : Specific cutting force (N/mm <sup>2</sup> ) $q$ : Chip area (mm <sup>2</sup> ) $a_p$ : Depth of cut (mm) $f$ : Feed rate (mm/rev)
-------------------	--	---

### Cutting Speed and Cutting Force

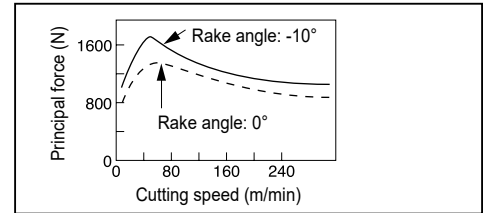

### Rake Angle and Cutting Force

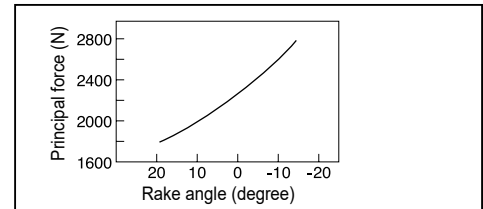

### Calculating Cutting Speed

① Calculating rotational speed from cutting speed

$n = \frac{1000 \cdot v_c}{\pi \cdot D}$	$n$ : Spindle speed (min <sup>-1</sup> ) $v_c$ : Cutting speed (m/min) $D$ : Diameter of workpiece (mm) $\pi \approx 3,14$
--	---

(Eg.)  $v_c = 150$  m/min,  $D = 100$  mm

$$n = \frac{1000 \times 150}{3,14 \times 100} = 478 \text{ (min}^{-1}\text{)}$$

② Calculating cutting speed from rotational speed

$v_c = \frac{\pi \cdot D \cdot n}{1.000}$	Refer to the above table
---	--------------------------

$n$  : Spindle speed (min<sup>-1</sup>)  
 $v_c$  : Cutting speed (m/min)  
 $f$  : Feed rate (mm/rev)  
 $a_p$  : Depth of cut (mm)  
 $D_m$  : Diameter of workpiece (mm)

### Feed Rate and Specific Cutting Force (For carbon steel)

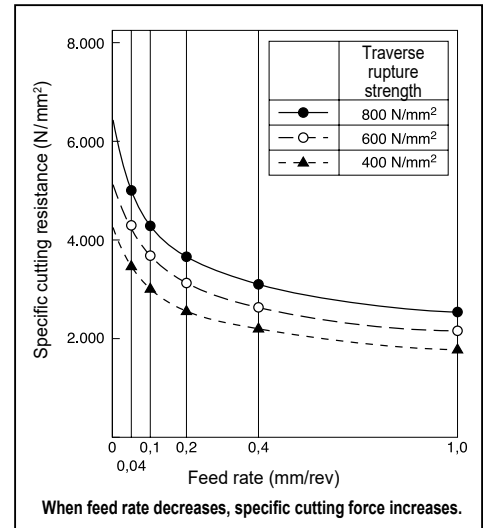

### Roughness

● Theoretical Surface Finish

$R_z = \frac{f^2}{8 \times r}$	$R_z$ : Surface finish (mm) $f$ : Feed rate (mm/rev) $r$ : Nose radius (mm)
--------------------------------	---

● Actual surface roughness

Steel : Theoretical surface finish x 1,5–3  
 Cast iron : Theoretical surface finish x 3–5

● Ways to Improve Surface Finish

- Use an insert with a larger nose radius.
- Optimize the cutting speed and feed rate so that built-up edge does not occur.
- Select an appropriate insert grade.
- Use wiper insert.

### Nose Radius and Cutting Force

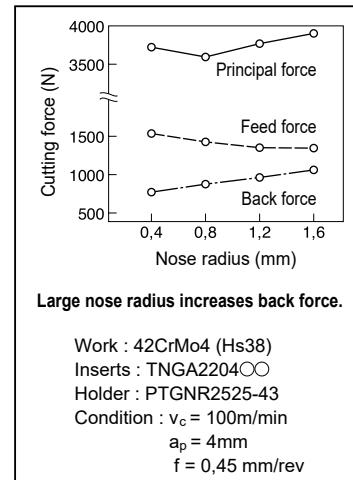

## Forms of Tool Failures

	Cat.	No.	Name of Failure	Cause of Failure
	Resulting from Mechanical causes	1~5	Flank Wear	Due to the scratching effect of hard grains contained in the work material.
		6	Chipping	Fine breakages caused by high cutting loads or chattering.
		7	Fracture	Due to the impact of an excessive mechanical force acting on the cutting edge.
	Resulting from Chemical reactions	8	Crater Wear	Swafft chips removing tool material as it flow over the top face at high temperatures.
		9	Plastic Deformation	Cutting edge is depressed due to softening at high temperatures.
		10	Thermal Crack	Fatigue from rapid, repeated heating and cooling cycles during machining.
		11	Built-up Edge	Work material is pressure welded on the top face of the cutting edge.

## Tool Wear

**Forms of Tool Wear**

Bad chip control  
Cutting edge fracture

Creater wear  $K_T$

Burs occur

Poor surface finish

Face flank wear  $V_{N2}$

Side flank wear  $V_{N1}$

Edge wear  $V_c$

Flank wear  $V_B$

Higher cutting force

Poor machining accuracy  
Burs occur

	Flank wear	Crater wear
<p>Wear is rapid initially, then it proceeds more gradually in proportion with cutting time until a certain limit, beyond which it increases rapidly again.</p>	<p>Crater wear is more progressive with no sudden breakdown pattern.</p>	

## Tool Life (V-T)

Measure the relative tool lives of the specified wear, over a range of cutting speeds, then plot the tool life along the X-axis and the cutting speed along the Y-axis on a double logarithm graph.

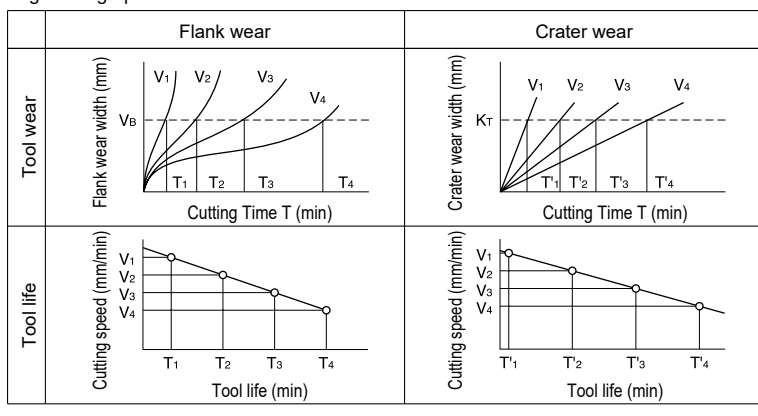





# Technical Guidance

## Tool Failure and Remedies

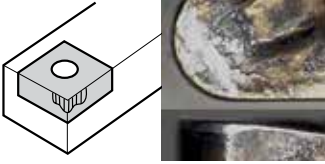
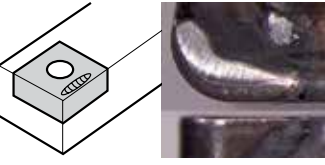
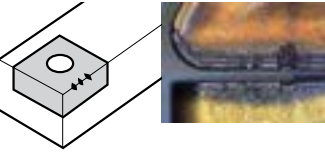
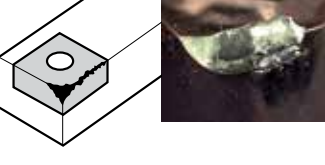
### ■ Trouble Shooting Guide for Turning

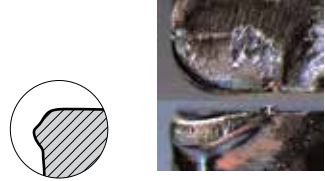
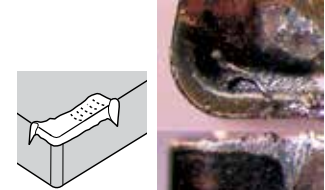
	Damage	Cause	Countermeasures
Tool Edge Failure	<p>Excessive flank wear</p> 	<ul style="list-style-type: none"> <li>- Grade lacks wear resistance.</li> <li>- Cutting speed is too fast.</li> <li>- Feed rate is far too slow.</li> </ul>	<ul style="list-style-type: none"> <li>- Select a wear resistant grade. P30 ⇨ P20 ⇨ P10 K20 ⇨ K10 ⇨ K01</li> <li>- Use an insert with a larger rake angle.</li> <li>- Decrease the cutting speed.</li> <li>- Increase feed rates.</li> </ul>
	<p>Excessive crater wear</p> 	<ul style="list-style-type: none"> <li>- Grade lacks crater wear resistance.</li> <li>- Rake angle is too small.</li> <li>- Cutting speed is too fast.</li> <li>- Feed rate and depth of cut are too large.</li> </ul>	<ul style="list-style-type: none"> <li>- Select a more crater-resistant grade.</li> <li>- Use an insert with a larger rake angle.</li> <li>- Select an appropriate chipbreaker.</li> <li>- Decrease the cutting speed.</li> <li>- Decrease the D.O.C. and feed rate.</li> </ul>
	<p>Cutting edge chipping</p> 	<ul style="list-style-type: none"> <li>- Grade lacks toughness.</li> <li>- Insert falls off due to chip build-up.</li> <li>- Cutting edge lacks toughness.</li> <li>- Feed rate and depth of cut are too large.</li> </ul>	<ul style="list-style-type: none"> <li>- Change to tougher grades. P10 ⇨ P20 ⇨ P30 K01 ⇨ K10 ⇨ K20</li> <li>- Increase amount of honing on cutting edge.</li> <li>- Reduce rake angle.</li> <li>- Reduce feed rates and depth of cut.</li> </ul>
	<p>Cutting edge fracture</p> 	<ul style="list-style-type: none"> <li>- Grades lacks toughness.</li> <li>- Cutting edge lacks toughness.</li> <li>- Holder lacks toughness.</li> <li>- Feed rate is too fast.</li> <li>- Depth of cut is too large.</li> </ul>	<ul style="list-style-type: none"> <li>- Change to tougher grades. P10 ⇨ P20 ⇨ P30 K01 ⇨ K10 ⇨ K20</li> <li>- Select a chipbreaker with a strong cutting edge.</li> <li>- Select a holder with a larger approach angle.</li> <li>- Select a holder with a larger shank size.</li> <li>- Decrease the D.O.C. and feed rate.</li> </ul>
	<p>Build-up edge</p> 	<ul style="list-style-type: none"> <li>- Inappropriate grade selection.</li> <li>- Dull cutting edge.</li> <li>- Cutting speed is too slow.</li> <li>- Feed rate is too slow.</li> </ul>	<ul style="list-style-type: none"> <li>- Select a grade with less affinity to the work material. Coated carbide or cermet grades.</li> <li>- Select a grade with a smooth coating.</li> <li>- Use an insert with a larger rake angle.</li> <li>- Reduce amount of honing.</li> <li>- Increase cutting speeds.</li> <li>- Increase feed rates.</li> </ul>
	<p>Plastic deformation</p> 	<ul style="list-style-type: none"> <li>- Grade lacks thermal resistance.</li> <li>- Cutting speed is too fast.</li> <li>- Feed rate is too fast.</li> <li>- Depth of cut is too large.</li> <li>- Not enough cutting fluid.</li> </ul>	<ul style="list-style-type: none"> <li>- Select a more crater-wear-resistant grade.</li> <li>- Use an insert with a larger rake angle.</li> <li>- Decrease the cutting speed.</li> <li>- Reduce feed rates and depth of cut.</li> <li>- Supply a sufficient amount of coolant.</li> </ul>
	<p>Notch wear</p> 	<ul style="list-style-type: none"> <li>- Grade lacks wear resistance.</li> <li>- Rake angle is too small.</li> <li>- Cutting speed is too fast.</li> </ul>	<ul style="list-style-type: none"> <li>- Select a wear resistant grade. P30 ⇨ P20 ⇨ P10 K20 ⇨ K10 ⇨ K01</li> <li>- Use an insert with a larger rake angle.</li> <li>- Alter depth of cut to shift the notch location.</li> </ul>

## ■ Type of Chip Generation

	a	b	c	d
Shape				
Condition	Continuous chips with good surface finish.	Chip is sheared and separated by the shear angle.	Chips appear to be torn from the surface.	Chips crack before reaching the cutting point.
Application	Steel, Stainless steel	Steel, Stainless steel (Low speed)	Steel, Cast iron (Very low speed, very small feedrate)	Cast iron, Carbon
Influence factor	Easy ← Work deformation → Difficult Large ← Rake angle → Small Small ← D.O.C. → Large Fast ← Cutting speed → Slow			

## ■ Type of Chip Control

Feed rate	A	B	C	D	E
Large feed rate					
Small feed rate					
NC lathe (For automation)	×	×	○	○	△
General lathe (For safety)	×	○	○	○ ~ △	×

Good : C type, D type

Poor {  
 A type : Twines around the tool or workpiece, damages the machined surface and affects safety.  
 B type : Bulky, causes problems in the automatic chip conveyor and chipping occurs easily.  
 E type : Causes spraying of chips, poor machined surface due to chattering, chipping, large cutting force and high temperatures.

## ■ Factor of Improvement Chip Control

### ① Increase feed rate

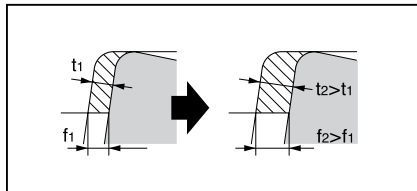

When feedrate increase, chips become thick and chip control improves.

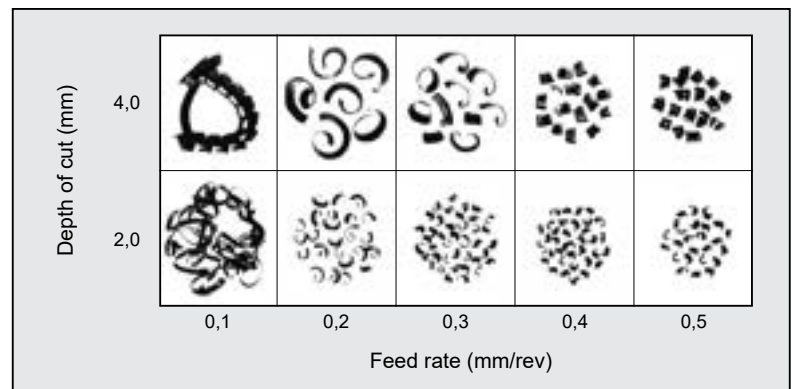

### ② Decrease side cutting edge

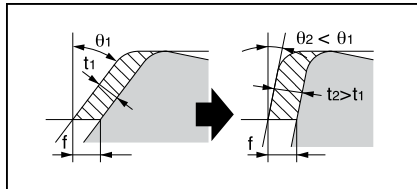

Even if feed rate is the same, smaller side cutting edge angle makes chips thick and chip control improves.

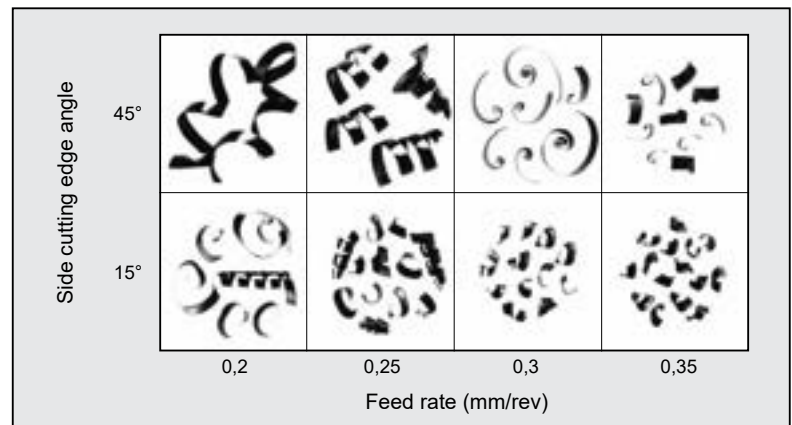

### ③ Decrease nose radius

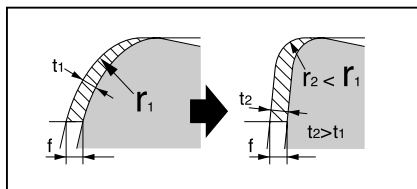

Even if depth of cut is the same, smaller nose radius makes chip thick and chip control improves.

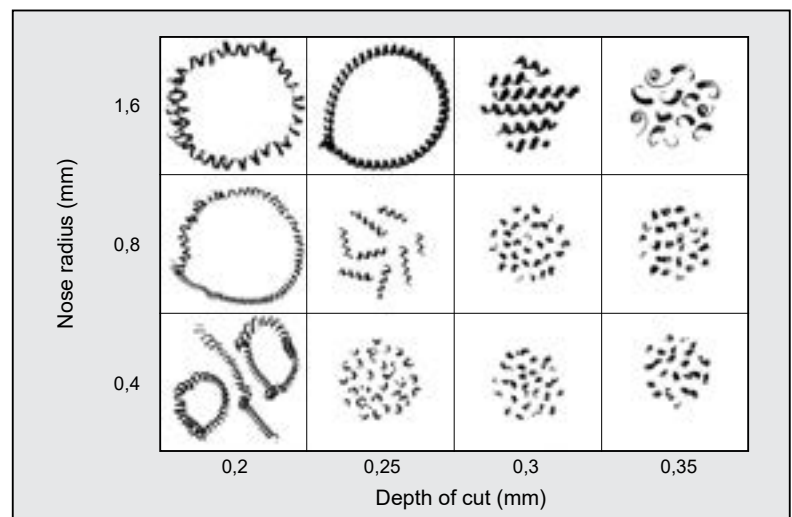

\* Cutting resistance increases in proportion with the width of the contact surface. Therefore, with a larger nose radius, cutting resistance and back force increases, chattering may also occur. However, with the same feedrate, a smaller nose radius would produce a poorer surface finish.

# Technical Guidance

## Basics of Milling

### Parts of a Milling Cutter

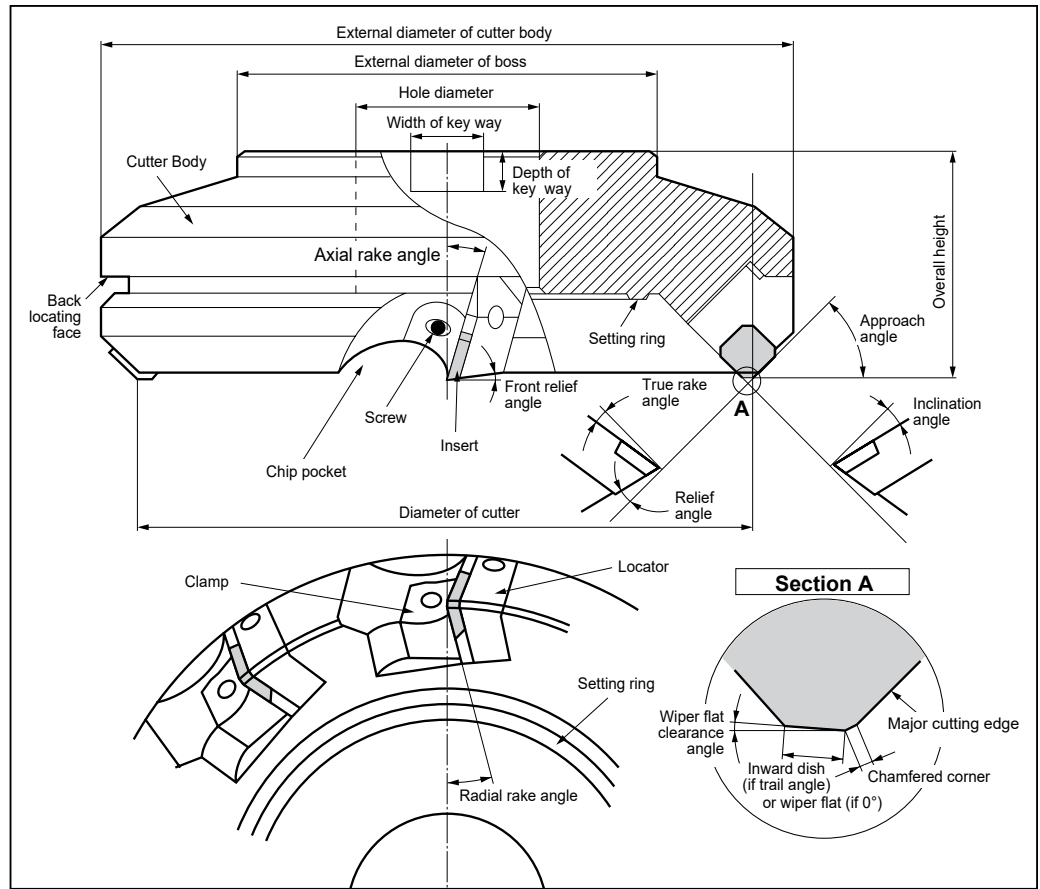

### Power Requirement

#### Calculating cutting force

$$P_c = \frac{a_p \cdot a_e \cdot v_f \cdot K_c}{60 \times 10^6 \times \eta} \text{ (kW)}$$

#### Horsepower

$$H = \frac{P_c}{0,75}$$

#### Chip removal amount

$$Q = \frac{a_p \times a_e \times v_f}{1.000} \text{ (cm}^3\text{/min)}$$

$P_c$  : Net power requirement (kW)

$H$  : Horsepower requirement (HP)

$Q$  : Chip removal amount (cm<sup>3</sup>/min)

$a_e$  : Cutting width (mm)

$v_f$  : Feed speed (mm/min)

$a_p$  : Depth of cut (mm)

$\eta$  : Machine efficiency (0,70 ~ 0,85)

$K_c$  : Specific cutting force (N/mm<sup>2</sup>)

Eg. rough value

( Steel : 2.500 ~ 3.000  
Cast iron : 1.500 )

#### Relation between feed rate, work material, specific cutting force

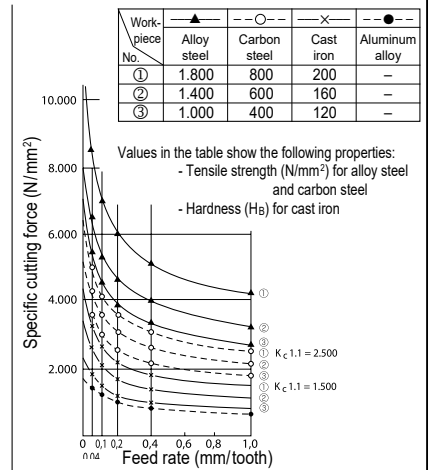

#### Calculating cutting speed

$$v_c = \frac{\pi \times D \times n}{1.000}$$

$v_c$  : Cutting speed (m/min)

$\pi \approx 3,14$

$D$  : Cutter diameter (mm)

$n$  : Rotation speed (rpm)

#### Calculating feed rate

$$v_f = f_z \times z \times n$$

$v_f$  : Feed speed (mm/min)

$f_z$  : Feed rate (mm/tooth)

$z$  : Number of teeth

$$f_z = \frac{v_f}{z \times n}$$

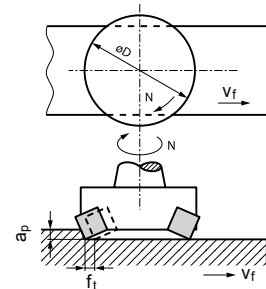

### Functions of the Various Cutting Angles

	Description	Code	Functions	Influences
①	Axial rake angle	$\gamma_y$	Controls chip removal direction, effects adhesion of the chips and thrust force etc.	Rake angles can vary from positive to negative (large to small) with typical combinations of positive and negative, positive and positive or negative and negative configurations.
②	Radial rake angle	$\gamma_x$		
③	Approach angle	$\kappa$	Controls chip thickness and chip removal direction	The effect of the small approach angle is to reduce the chip thickness and cutting force.
④	True rake angle (Effective rake angle)	$\gamma$	Controls cutting performance and ability to retain a cutting edge	<ul style="list-style-type: none"> <li>- With a positive (large) angle, cutting ability and adhesion resistance are improved but the strength of the cutting edge is weakened.</li> <li>- With negative (small) angle, the strength of the cutting edge is improved but chips will tend to adhere more easily.</li> </ul>
⑤	Inclination angle	$\lambda$	Controls chip removal direction	- With a positive (large) angle, the chip removal is satisfactory with less cutting resistance but the strength of the corner is weaker.
⑥	Wiper flat clearance angle	$\alpha_f$	Controls surface finish	A smaller clearance angle will produce a better surface finish.
⑦	Clearance angle	$\alpha$	Controls edge strength, tool life and chattering, etc	

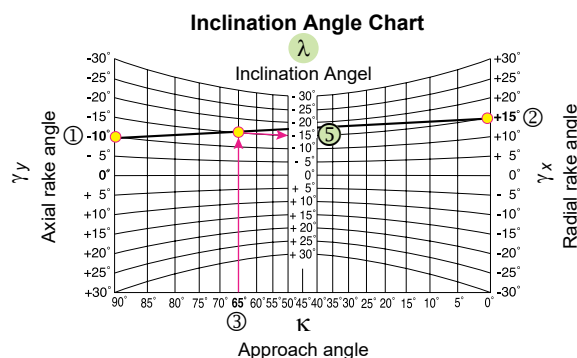
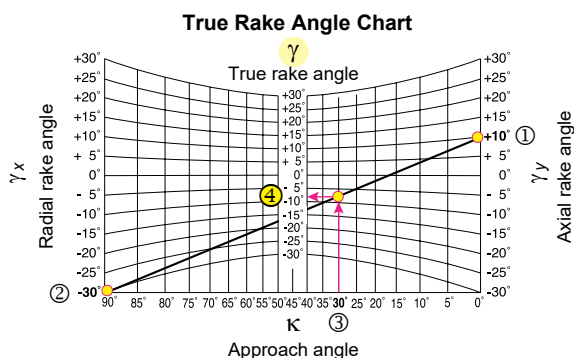

Example in using the above chart:	Solution:
① $\gamma_y$ : Axial rake angle = +10°	True rake angle
② $\gamma_x$ : Radial rake angle = -30°	④ $\gamma = -8^\circ$
③ $\kappa$ : Approach angle = 30°	

Formula :  $\tan \gamma = \tan \gamma_x \cdot \sin \kappa + \tan \gamma_y \cdot \cos \kappa$

Example in using the above chart :	Solution:
① $\gamma_y$ : Axial rake angle = -10°	Inclination angle
② $\gamma_x$ : Radial rake angle = +10°	⑤ $\lambda = -15^\circ$
③ $\kappa$ : Approach angle = 65°	

Formula :  $\tan \lambda = \tan \gamma_y \cdot \sin \kappa - \tan \gamma_x \cdot \cos \kappa$

### Rake Angle Combination

	Negative - Positive Type	Double Positive Type	Double Negative Type
<p>The effects of the various angle configurations with relation to chip formation and chip removal.</p> <p>Chip removal direction</p> <p>Rotation</p>			
Advantage	Excellent chip removal and good cutting action	Good cutting action	Double-sided inserts can be use and higher cutting edge strength
Disadvantage	Only single-sided inserts can be use	Lower cutting edge strength and only single-sided inserts can be use	Dull cutting action
Application	For Steel, Cast iron, Stainless steel, Alloy steel	For general milling of steel For low rigidly work piece	For light milling of cast iron and steel
Typical cutter	WGX, WGC, UFO	DPG	DNX, DGC, DNF
Chips (Eg.) Workpiece: 37Cr4 $v_c = 130$ m/min $f_t = 0.23$ mm/tooth $a_p = 3$ mm			

# Technical Guidance

## Basics of Milling

### Relation Between Engage Angle and Tool Life

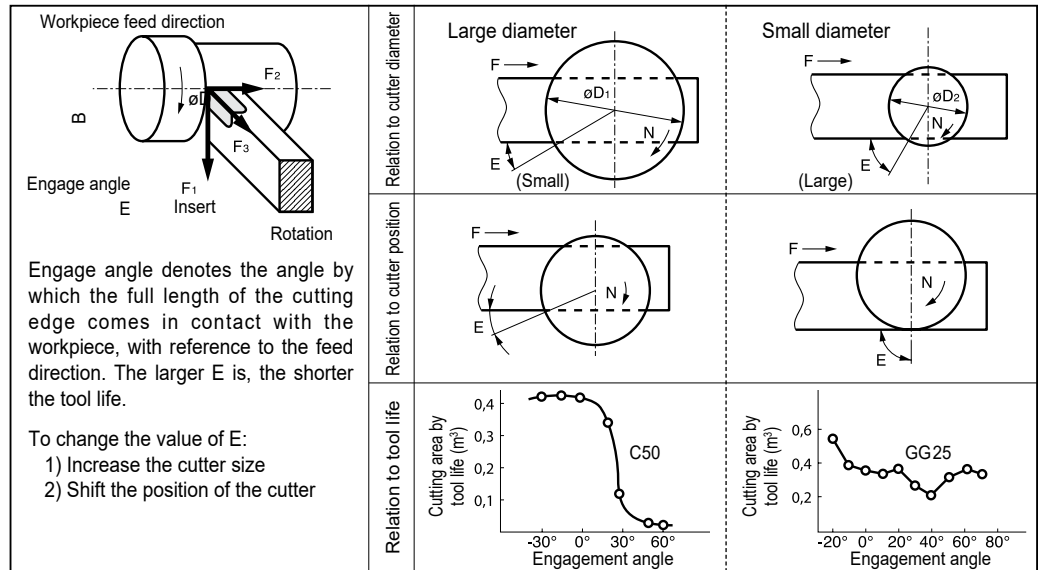

### Relation between the number of simultaneously engaged cutting edges and cutting force:

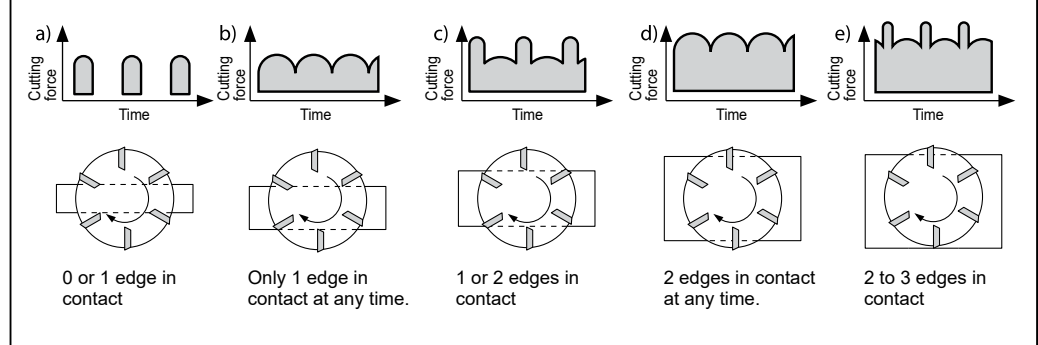

### To Improve Surface Roughness

#### ① Milling inserts with wiper flat

When all the cutting edges have wiper flats, a few teeth are intentionally elevated to play the role of a wiper insert.

- Insert equipped with straight wiper flat (Face angle: Approx  $15^\circ - 1^\circ$ )
- Insert equipped with curved wiper flat (Eg. curvature R500)

#### ● Surface roughness without wiper flat

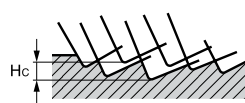

#### ● Surface roughness with straight wiper flat

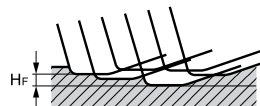

$h$ : Projected value of wiper insert

Steels: 0,05 mm  
Al: 0,03 mm

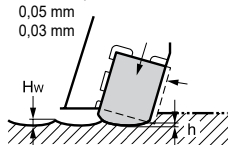

$f$ : Feed rate per revolution

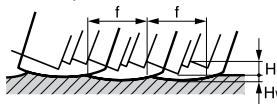

$H_c$ : Surface roughness with only normal teeth  
 $H_w$ : Surface roughness with wiper insert

#### ● Influence of different face angles on surface finish

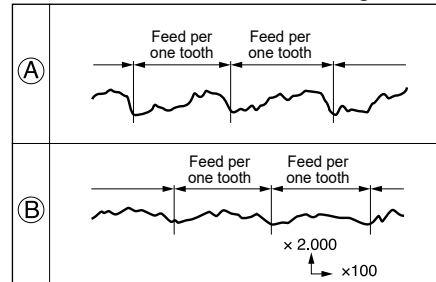

- Workpiece: 34CrMo4  
- Cutter: DPG 5160 R (Single tooth)

-  $v_c = 154$  m/min  
 $f_z = 0,234$  mm/tooth  
 $a_p = 2$  mm

- Face angle

(A):  $28^\circ$   
(B):  $6^\circ$

#### ② Integral wiper insert system

A system to protrude one or two inserts (wiper insert) with a smooth curved edge just a little beyond the other teeth to wipe the milled surface.

- (Applies to WGC, RF types etc.)

#### ● Effects of having wiper insert (example)

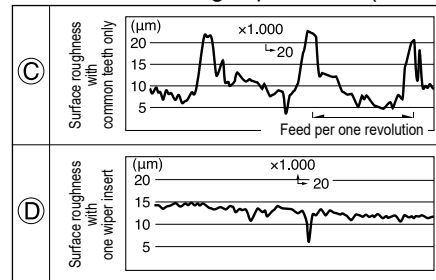

- Workpiece: GG25  
- Cutter: DPG 4100 R  
- Insert: SPKN 1203  
- Axial run-out: 0,015 mm  
- Radial run-out: 0,04 mm

-  $v_c = 105$  m/min  
 $f_z = 0,29$  mm/tooth (1,45 mm/rev)

(C): Only normal teeth  
(D): with 1 wiper insert

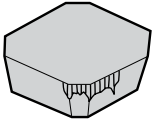
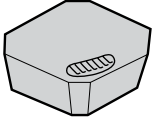
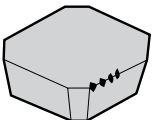
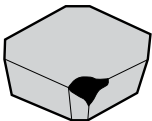

### ■ Trouble Shooting Guide for Milling

Trouble		Basic Remedies		Remedy Examples															
Cutting Edge Failure	Excessive Flank Wear 	Tool Material	<ul style="list-style-type: none"> <li>Select a more wear resistant grade. Carbide</li> <li>P30 ⇒ P20 ⇒ P30</li> <li>K20 ⇒ K10 ⇒ K10</li> <li>Coated Cermet</li> </ul>	- Recommended insert grades <table border="1"> <thead> <tr> <th></th> <th>Steel</th> <th>Cast Iron</th> <th>Non-Ferrous Alloy</th> </tr> </thead> <tbody> <tr> <td>Finishing</td> <td>T250A (Cermet)</td> <td>ACK200 (Coated Carbide) BN700 (SUMIBORON)</td> <td>DA1000 (SUMIDIA)</td> </tr> <tr> <td>Roughing</td> <td>ACP100 (Coated Carbide)</td> <td>ACK200 (Coated Carbide)</td> <td>DL1000 (Coated Carbide)</td> </tr> </tbody> </table>					Steel	Cast Iron	Non-Ferrous Alloy	Finishing	T250A (Cermet)	ACK200 (Coated Carbide) BN700 (SUMIBORON)	DA1000 (SUMIDIA)	Roughing	ACP100 (Coated Carbide)	ACK200 (Coated Carbide)	DL1000 (Coated Carbide)
		Steel	Cast Iron					Non-Ferrous Alloy											
	Finishing	T250A (Cermet)	ACK200 (Coated Carbide) BN700 (SUMIBORON)	DA1000 (SUMIDIA)															
	Roughing	ACP100 (Coated Carbide)	ACK200 (Coated Carbide)	DL1000 (Coated Carbide)															
	Cutting Conditions	<ul style="list-style-type: none"> <li>Reduce cutting speeds.</li> <li>Increase feedrate.</li> </ul>																	
Excessive Crater Wear 	Tool Material	<ul style="list-style-type: none"> <li>Select a crater resistant grade.</li> </ul>	- Recommended insert grades <table border="1"> <thead> <tr> <th></th> <th>Steel</th> <th>Cast Iron</th> <th>Non-Ferrous Alloy</th> </tr> </thead> <tbody> <tr> <td>Finishing</td> <td>T250A (Cermet)</td> <td>ACK200 (Coated Carbide)</td> <td>DA1000 (SUMIDIA)</td> </tr> <tr> <td>Roughing</td> <td>ACP100 (Coated Carbide)</td> <td>ACK200 (Coated Carbide)</td> <td>DL1000 (Coated Carbide)</td> </tr> </tbody> </table>					Steel	Cast Iron	Non-Ferrous Alloy	Finishing	T250A (Cermet)	ACK200 (Coated Carbide)	DA1000 (SUMIDIA)	Roughing	ACP100 (Coated Carbide)	ACK200 (Coated Carbide)	DL1000 (Coated Carbide)	
	Steel	Cast Iron					Non-Ferrous Alloy												
Finishing	T250A (Cermet)	ACK200 (Coated Carbide)	DA1000 (SUMIDIA)																
Roughing	ACP100 (Coated Carbide)	ACK200 (Coated Carbide)	DL1000 (Coated Carbide)																
	Cutting Conditions	<ul style="list-style-type: none"> <li>Reduce cutting speeds.</li> <li>Reduce depth-of-cut and feed rate.</li> </ul>																	
Cutting Edge Chipping 	Tool Material	<ul style="list-style-type: none"> <li>Select tougher grade. P10 ⇒ P20 ⇒ P30</li> <li>K01 ⇒ K10 ⇒ K20</li> </ul>	- Recommended insert grades <table border="1"> <thead> <tr> <th></th> <th>Steel</th> <th>Cast Iron</th> </tr> </thead> <tbody> <tr> <td>Finishing</td> <td>ACP200 (Coated Carbide)</td> <td>ACK200 (Coated Carbide)</td> </tr> <tr> <td>Roughing</td> <td>ACP300 (Coated Carbide)</td> <td>ACK300 (Coated Carbide)</td> </tr> </tbody> </table>					Steel	Cast Iron	Finishing	ACP200 (Coated Carbide)	ACK200 (Coated Carbide)	Roughing	ACP300 (Coated Carbide)	ACK300 (Coated Carbide)				
	Steel	Cast Iron																	
Finishing	ACP200 (Coated Carbide)	ACK200 (Coated Carbide)																	
Roughing	ACP300 (Coated Carbide)	ACK300 (Coated Carbide)																	
	Cutting Conditions	<ul style="list-style-type: none"> <li>Reduce feed rates.</li> </ul>																	
	Tool Design	<ul style="list-style-type: none"> <li>Select a negative-positive cutter configuration with a large approach angle.</li> <li>Reinforce the cutting edge (Honing).</li> <li>Select a strong edge insert (G → H).</li> </ul>	- Recommended cutter: WaveMill WGX type - Cutting conditions: Refer to recommended conditions listed in the general catalogue																
Partial Fracture of Cutting Edges 	Tool Material	<ul style="list-style-type: none"> <li>If it is due to excessive low speeds or very low feed rates, select an adhesion resistant grade.</li> <li>If it is due to thermal cracking, select a thermal impact resistant grade.</li> </ul>	- Recommended insert grades <table border="1"> <thead> <tr> <th></th> <th>Steel</th> <th>Cast Iron</th> </tr> </thead> <tbody> <tr> <td>Roughing</td> <td>ACP300 (Coated Carbide)</td> <td>ACK300 (Coated Carbide)</td> </tr> </tbody> </table>					Steel	Cast Iron	Roughing	ACP300 (Coated Carbide)	ACK300 (Coated Carbide)							
	Steel	Cast Iron																	
Roughing	ACP300 (Coated Carbide)	ACK300 (Coated Carbide)																	
	Cutting Conditions	<ul style="list-style-type: none"> <li>Select appropriate conditions with regards to the particular application.</li> </ul>																	
	Tool Design	<ul style="list-style-type: none"> <li>Select a negative-positive (or negative) cutter configuration with a large approach angle.</li> <li>Reinforce the cutting edge (Honing).</li> <li>Select a strong edge insert (G → H).</li> <li>Increase insert size - (Thickness in particular).</li> </ul>	- Recommended cutter: WaveMill WGX type - Insert thickness: 3,18 → 4,76 mm - Insert type: Standard → Strong edge type - Cutting conditions: Refer to recommended conditions listed in the general catalogue																
Others	Unsatisfactory Machined Surface Finish	Tool Material	<ul style="list-style-type: none"> <li>Select an adhesion resistant grade. Carbide → Cermet</li> </ul>	- Recommended insert grades <table border="1"> <thead> <tr> <th></th> <th>Steel</th> <th>Cast Iron</th> <th>Non-Ferrous Alloy</th> </tr> </thead> <tbody> <tr> <td>Roughing</td> <td>WGX type* ACP200 (Coated Carbide)</td> <td>DGC type* ACK200 (Coated Carbide)</td> <td>FF type* H1 (Carbide) DL1000 (Coated Carbide)</td> </tr> <tr> <td>Finishing</td> <td>WGC type T250A (Cermet)</td> <td>FMU type BN700 (SUMIBORON)</td> <td>RF type DA1000 (SUMIDIA)</td> </tr> </tbody> </table>					Steel	Cast Iron	Non-Ferrous Alloy	Roughing	WGX type* ACP200 (Coated Carbide)	DGC type* ACK200 (Coated Carbide)	FF type* H1 (Carbide) DL1000 (Coated Carbide)	Finishing	WGC type T250A (Cermet)	FMU type BN700 (SUMIBORON)	RF type DA1000 (SUMIDIA)
		Steel	Cast Iron					Non-Ferrous Alloy											
	Roughing	WGX type* ACP200 (Coated Carbide)	DGC type* ACK200 (Coated Carbide)	FF type* H1 (Carbide) DL1000 (Coated Carbide)															
	Finishing	WGC type T250A (Cermet)	FMU type BN700 (SUMIBORON)	RF type DA1000 (SUMIDIA)															
		Cutting Conditions	<ul style="list-style-type: none"> <li>Increase cutting speeds.</li> </ul>																
	Tool Design	<ul style="list-style-type: none"> <li>Improve axial run-out of cutting edges. (Use a cutter with less run-out) (Attach correct inserts)</li> <li>Use wiper inserts.</li> <li>Use special purpose cutters designed for finishing.</li> </ul>	* marked cutters can be fitted with wiper inserts.																
Chattering	Cutting Conditions	<ul style="list-style-type: none"> <li>Reduce feed rates.</li> </ul>	- Recommended cutters: For steel: WaveMill WGX type For cast iron: DNX type For Non-ferrous alloy: High speed cutter for aluminium RF type																
	Tool Design	<ul style="list-style-type: none"> <li>Select a high rake cutter with sharp cutting edges</li> <li>Use an irregular pitched cutter.</li> <li>Improve workpiece and cutter clamp rigidity.</li> </ul>																	
	Others	<ul style="list-style-type: none"> <li>Use an irregular pitched cutter.</li> <li>Improve workpiece and cutter clamp rigidity.</li> </ul>																	
Unsatisfactory Chip Control	Tool Design	<ul style="list-style-type: none"> <li>Select cutter with good chip removal features.</li> <li>Reduce number of teeth.</li> <li>Enlarge chip pocket.</li> </ul>	- Recommended cutter: WaveMill WGX type																
Edge Chipping on Workpiece	Tool Design	<ul style="list-style-type: none"> <li>Select a large approach angle.</li> <li>Select a sharp cutting edge insert (G → L).</li> </ul>	- Recommended cutter: WaveMill WGX type																
	Cutting Conditions	<ul style="list-style-type: none"> <li>Reduce feed rates.</li> </ul>																	
Burr on Workpiece	Tool Design	<ul style="list-style-type: none"> <li>Select a cutter with sharp cutting edges.</li> </ul>	- Recommended cutter: WaveMill WGX type + FG breaker DGC type + FG breaker																
	Cutting Conditions	<ul style="list-style-type: none"> <li>Increase feed rates.</li> </ul>																	



# Technical Guidance

## Basics of Endmilling

### Parts of an Endmill

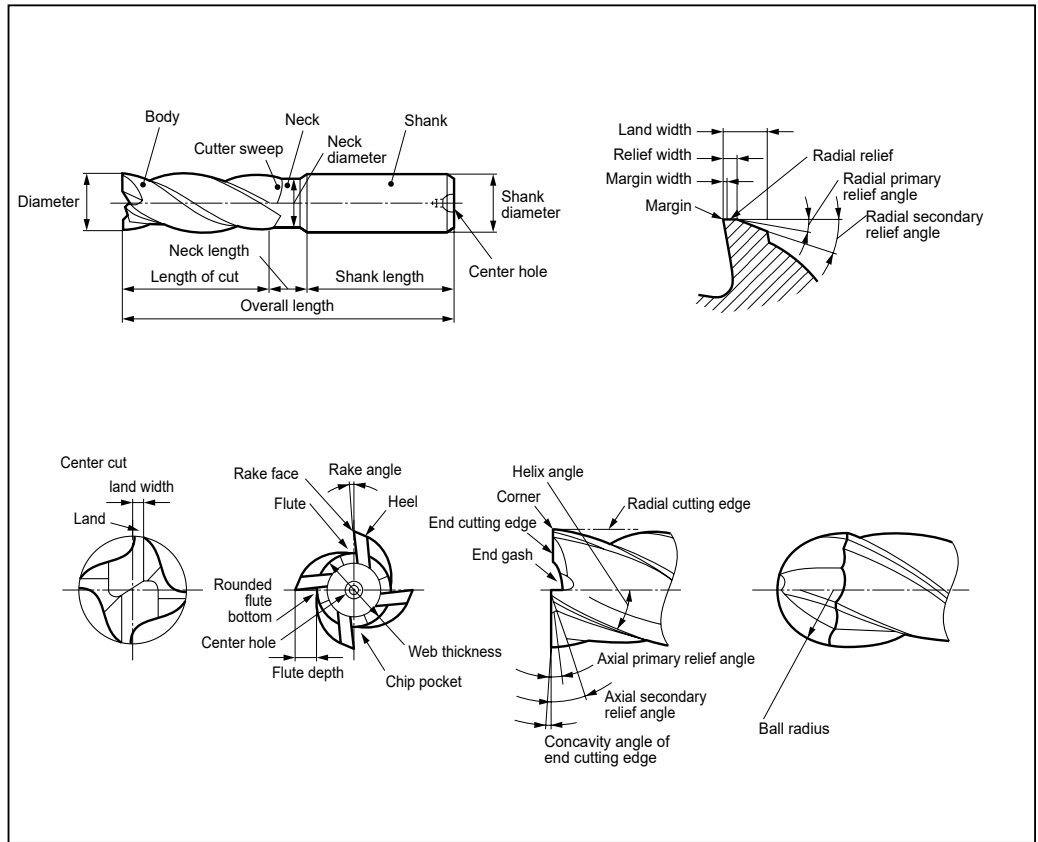

### Calculating Cutting Conditions

#### ● Cutting speed

$$v_c = \frac{\pi \cdot D \cdot n}{1.000} \quad n = \frac{1.000 \cdot v_c}{\pi \cdot D}$$

#### ● Feed rate

$$v_f = f \times n$$

$$v_f = f_z \times z \times n \quad f_z = \frac{v_f}{z \times n}$$

#### ● Depth of cut (D.O.C)

$a_p$  : Axial D.O.C. (depth)  
 $a_e$  : Radial D.O.C. (width)

#### ● Notch width ( $D_1$ )

$$D_1 = 2 \times \sqrt{2 \times R \times a_p - a_p^2}$$

#### ● Cutting speed and feedrate are calculated using the same formula as square endmill.

Side milling

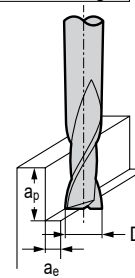

$v_c$  : Cutting speed (m/min)

$\pi \approx 3,14$

$D$  : Endmill diameter (mm)

$n$  : Rotational speed ( $\text{min}^{-1}$ )

$v_f$  : Feed speed (mm/min)

$f_r$  : Feed rate per revolution (mm/rev)

$f_z$  : Feed rate per tooth (mm/tooth)

$z$  : Number of teeth

Slotting

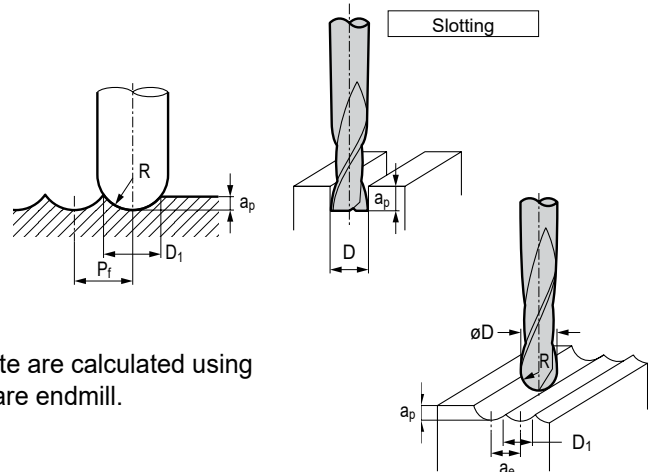

(Ball Endmill)

### Up-cut and Down-cut

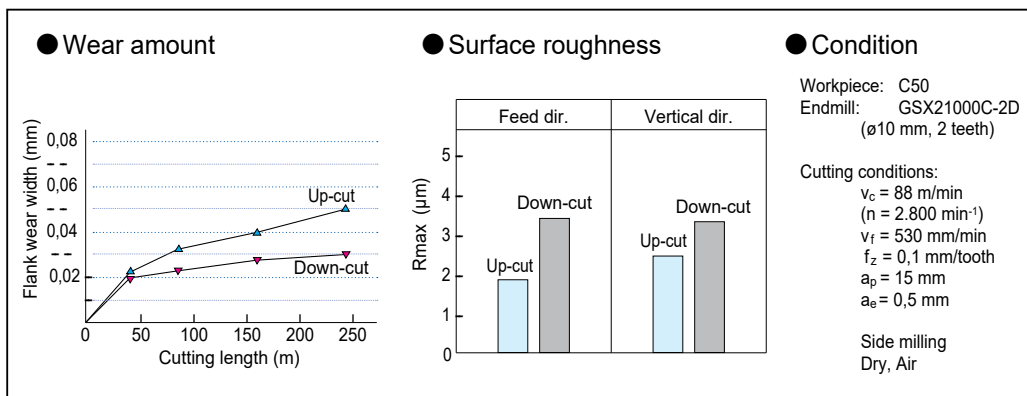
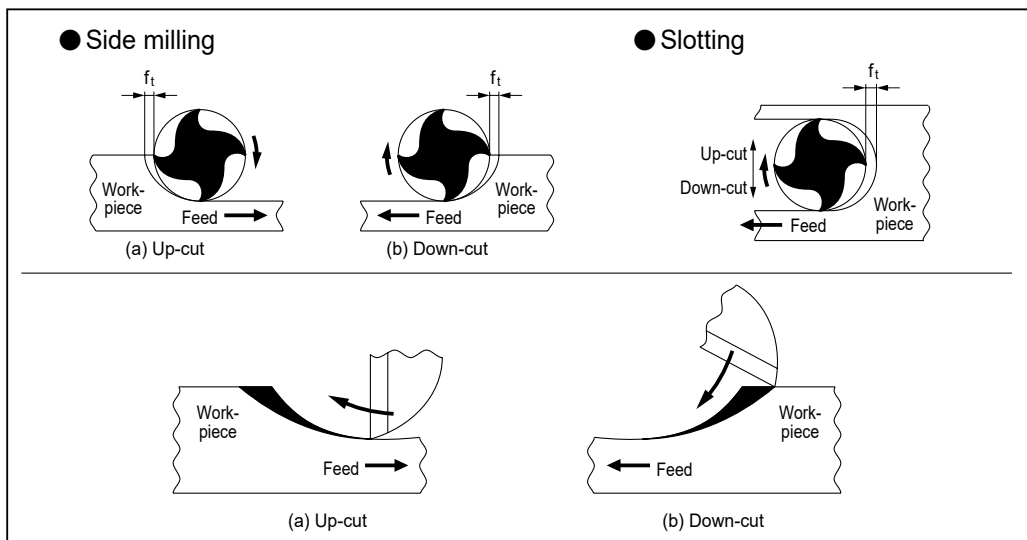

### Relation Between Cutting Condition and Deflection

Endmill			Side milling		Slotting					
			Work material: Pre-hardened steel (40HRC) Cutting data: $v_c = 25 \text{ m/min}$ $a_p = 12 \text{ mm}$ $a_e = 0,8 \text{ mm}$		Work material: Pre-hardened steel (40HRC) Cutting data: $v_c = 25 \text{ m/min}$ $a_p = 8 \text{ mm}$ $a_e = 8 \text{ mm}$					
Cat. No.	Number of teeth	Helix angle	Feed rate		Feed rate		Feed rate		Feed rate	
			0,16 mm/rev	0,11 mm/rev	0,05 mm/rev	0,03 mm/rev				
			Style		Style		Style		Style	
			Up-cut	Down-cut	Up-cut	Down-cut	Up-cut	Down-cut	Up-cut	Down-cut
SSM 2080	2	30°								
SSM 4080	4	30°								

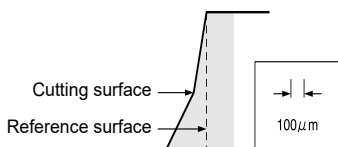

# Technical Guidance

## Tool Failure and Remedies

### ■ Trouble Shooting Guide for Endmilling

Failure		Cause		Remedies
Cutting Edge Failure	Excessive Wear	Cutting Conditions Tool Shape Tool Material	<ul style="list-style-type: none"> <li>- Cutting speed is too fast</li> <li>- Feed rate is too fast</li> <li>- The flank relief angle ist too small</li> <li>- Insufficient wear resistance</li> </ul>	<ul style="list-style-type: none"> <li>- Decrease cutting speed and feed rate.</li> <li>- Change to an appropriate flank relief angle.</li> <li>- Select a substrate with more wear resistance</li> <li>- Use a coated tool</li> </ul>
	Chipping	Cutting Conditions Machine Area	<ul style="list-style-type: none"> <li>- Feed rate ist too fast</li> <li>- Cutting depth is too deep</li> <li>- Tool overhang ist too long</li> <li>- Work clamps are weak</li> <li>- Tool is not firmly attached</li> </ul>	<ul style="list-style-type: none"> <li>- Decrease cutting speed.</li> <li>- Reduce depth of cut</li> <li>- Adjust tool overhang for correct length</li> <li>- Clamp the work piece firmly</li> <li>- Make sure the tool is seated in the chuck properly</li> </ul>
	Tool Fracture	Cutting Conditions	<ul style="list-style-type: none"> <li>- Feed rate ist too fast</li> <li>- Cutting depth is too deep</li> <li>- Tool overhang ist too long</li> <li>- Cutting edge is too long</li> </ul>	<ul style="list-style-type: none"> <li>- Decrease cutting speed.</li> <li>- Reduce depth of cut</li> <li>- Reduce tool overhang as much as possible</li> <li>- Select a tool with a shorter cutting edge</li> </ul>
Others	Shoulder Deflection	Cutting Conditions Tool Shape	<ul style="list-style-type: none"> <li>- Feed rate is too fast</li> <li>- Cutting depth is too deep</li> <li>- Tool overhang is too long</li> <li>- Cutting on the down-cut</li> <li>- Helix angle is large</li> </ul>	<ul style="list-style-type: none"> <li>- Decrease cutting speed.</li> <li>- Reduce depth of cut</li> <li>- Adjust tool overhang for correct length</li> <li>- Change directions to up-cut</li> <li>- Use a tool with a smaller helix angle</li> </ul>
	Unsatisfactory Machined Surface Finish	Cutting Conditions	<ul style="list-style-type: none"> <li>- Feed rate is too fast</li> <li>- Packing of chips</li> </ul>	<ul style="list-style-type: none"> <li>- Decrease cutting speed.</li> <li>- Use air blow</li> <li>- Use an insert with a larger relief pocket.</li> </ul>
	Chattering	Cutting Conditions Tool Shape Machine Area	<ul style="list-style-type: none"> <li>- Cutting speed is too fast</li> <li>- Cutting on the up-cut</li> <li>- Tool overhang is too long</li> <li>- Rake angle is large</li> <li>- Work clamps are weak</li> <li>- Tool is not firmly attached</li> </ul>	<ul style="list-style-type: none"> <li>- Decrease cutting speed.</li> <li>- Change directions to down-cut</li> <li>- Adjust tool overhang for correct length</li> <li>- Use a tool with an appropriate rake angle</li> <li>- Clamp the work piece firmly</li> <li>- Make sure the tool is seated in the chuck properly</li> </ul>
	Packing of Chip	Cutting Conditions Tool Shape	<ul style="list-style-type: none"> <li>- Feed rate is too fast</li> <li>- Cutting depth is too deep</li> <li>- Too many teeth</li> <li>- Packing of chips</li> </ul>	<ul style="list-style-type: none"> <li>- Decrease cutting speed.</li> <li>- Reduce depth of cut</li> <li>- Reduce number of teeth</li> <li>- Use air blow</li> </ul>

### Parts of a Drill

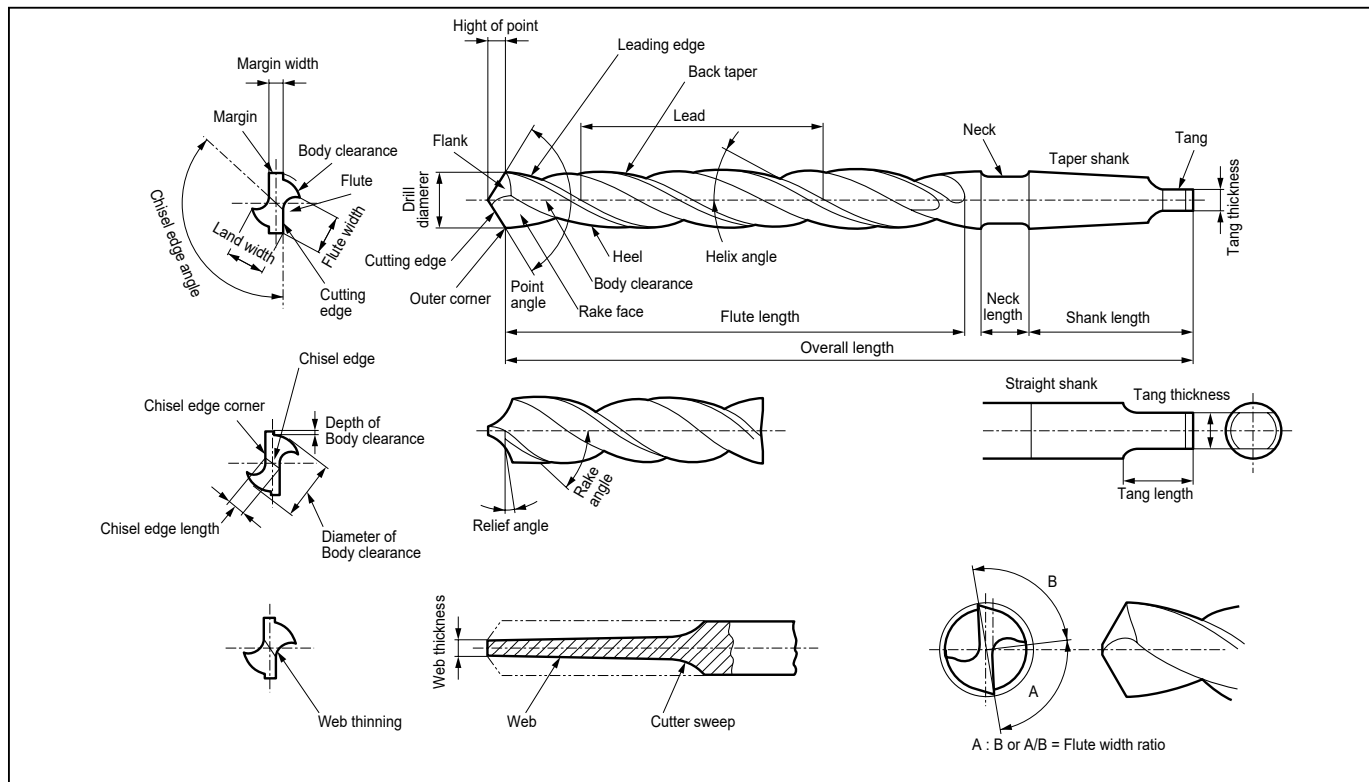

### Point Angle and Force

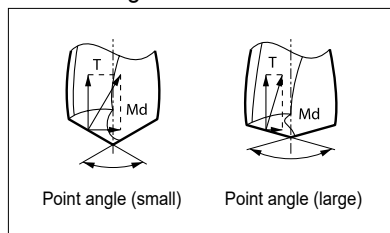

When point angle is large, thrust becomes large but torque becomes small.

### Min. Requirement Relief Angle

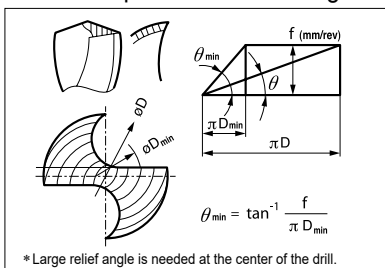

\* Large relief angle is needed at the center of the drill.

### Width of Edge Treatment and Cutting Force

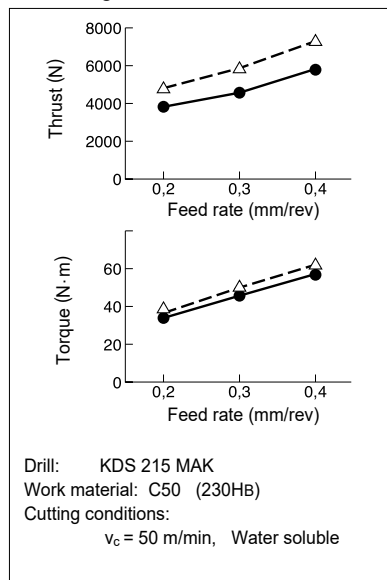

### Point Angle and Burr

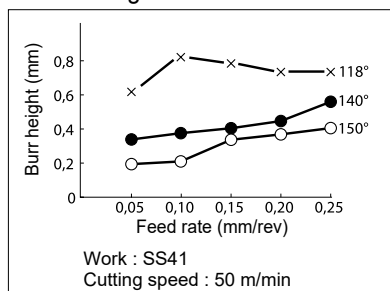

When point angle is large, burr height becomes low.

### Web Thickness and Thrust

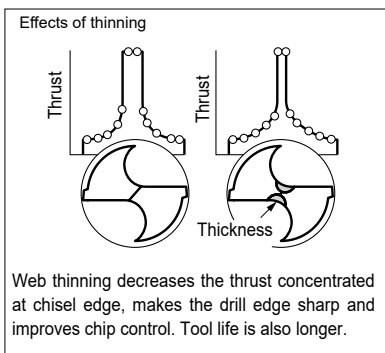

### Decrease Chisel Width by Thinning

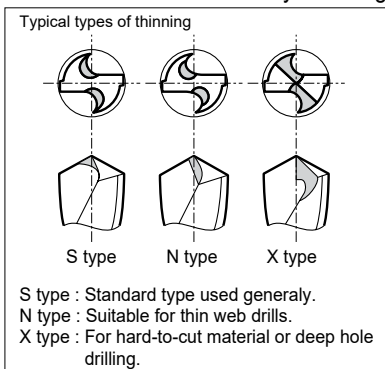

# Technical Guidance

## Basics of Drilling

### Reference of Power Requirement and Thrust

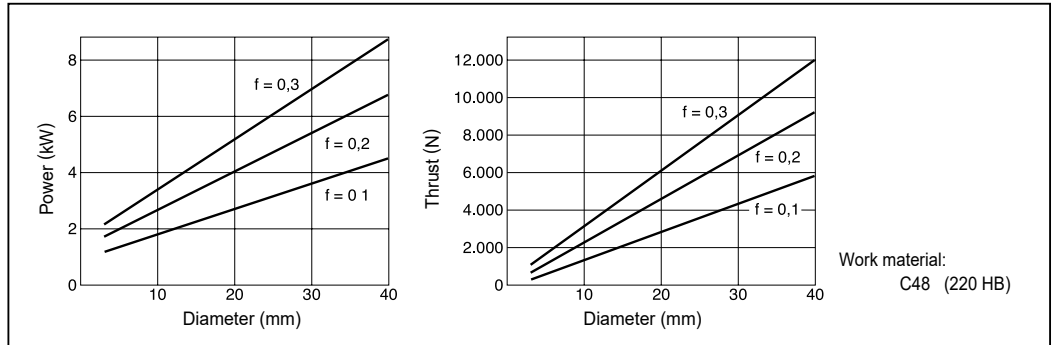

### Cutting Condition Selection

- Control cutting force for low rigid machine

The following table shows the relation between edge treatment width and cutting force. If a problem caused by cutting force occurs, reduce either the feedrate or the edge treatment width.

Condition		Edge treatment width			
		0,15 mm		0,05 mm	
$V_c$ (m/min)	$f$ (mm/rev)	Torque (N•m)	Thrust (N)	Torque (N•m)	Thrust (N)
40	0,38	12,8	2820	12,0	2520
50	0,30	10,8	2520	9,4	1920
60	0,25	9,2	2320	7,6	1640
60	0,15	6,4	1640	5,2	1.100

Drill :  $\phi 10$   
Work material: C50 (230 HB)

- High speed machining recommendation

When there is surplus capacity with enough machine power and rigidity drilling at normal recommended cutting conditions, we recommend higher drilling speeds.

Wear example

$V_c = 60$  m/min

$V_c = 120$  m/min

Work material: C50 (230HB)  
 Cutting data:  $f = 0,3$  mm/rev  
 $a_p = 50$  mm  
 Tool life: 600 holes (Cutting length : 30 m)

### Explanation of Margins (Difference between single and double margins)

● Single Margin (2 guides: circled parts)

● Shape used on most drills

● D Double Margin (4 guides: circled parts)

● 4-point guiding reduces hole bending and undulation for improved stability and accuracy during deep hole drilling.

### Run-out Accuracy

Run-out of the lip height B and thinning point A are important.

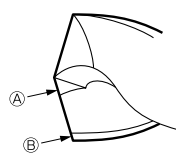

Ⓐ : The run-out accuracy of thinning point  
Ⓑ : The difference of lip height

Hole expansion (mm)	
Ⓐ	0,005    0,02    0,05    0,1
Ⓑ	0,005    0,02    0,1    0,05    0,02    0,1

MDS 140 MK  
50C  
vc = 50 m/min  
f = 0,3 mm/rev

### Peripheral Run-out Accuracy when Tool Rotates

Drill run-out when mounted on the machine spindle must be within 0,03 mm. If the run-out is large, the drilled hole will also be large causing an increase in the horizontal cutting force, which may result in drill breakage if the machine or work clamping is not rigid.

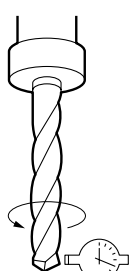

Run-out: within 0,03 mm

Peripheral run-out (mm)	Hole expansion (mm)	Horizontal cutting force (kg)
0,005	0,05	10
0,09	0,25	10

Drill: MDS120MK  
Work material: C50 (230HB)  
Cutting data:  $v_c = 50$  m/min,  $f = 0,3$  mm/rev,  $a_p = 38$ mm  
Water soluble

### Peripheral Run-out Accuracy when Workpiece Rotates

When use on a lathe, run-out at point A must be within 0,03 mm, this value must be similar when taken at position B.

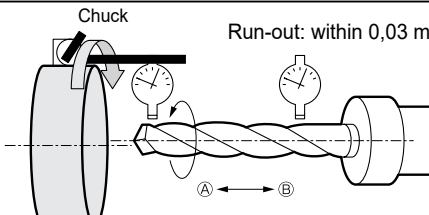

Run-out: within 0,03 mm

### Influence of Workpiece Surface

● Workpiece with slanted or uneven surface

If the surface of the hole entrance or exit is slanted or uneven, decrease the feedrate to 0,1–0,15 mm/rev at these points.

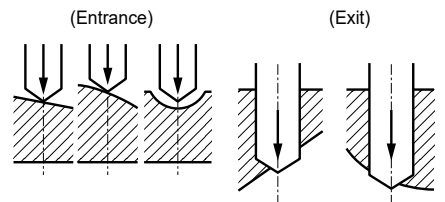

### How to Use Long Drill

● Problem

When using a long drill (e.g. XHGS type and XHT type), DAK type or SMDH-D type drills at high rotational speeds, the run-out of the drill tip may cause a position shift at the entry point making the drill hole bent and resulting in drill breakage.

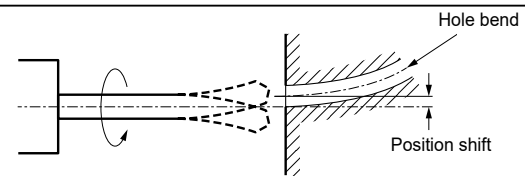

Hole bend  
Position shift

● Remedies

Method 1.

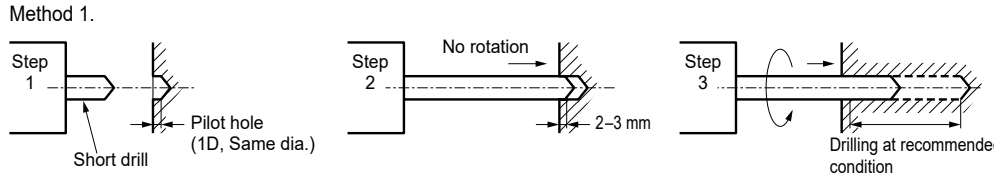

Step 1: Short drill, Pilot hole (1D, Same dia.)  
Step 2: No rotation, 2-3 mm  
Step 3: Drilling at recommended condition

Method 2. Low rotational speed minimizes centrifugal forces and prevents drill bending.

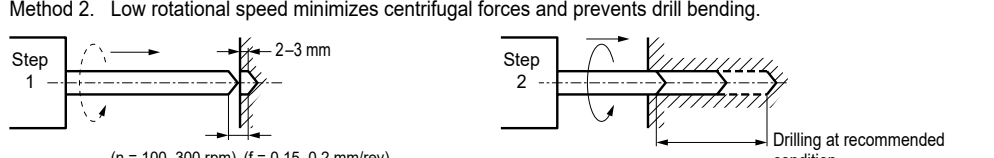

Step 1: (n = 100–300 rpm) (f = 0,15–0,2 mm/rev)  
Step 2: Drilling at recommended condition



# Technical Guidance

## Tool Failure and Remedies

### ■ Trouble Shooting Guide for Drilling

Failure		Basic Remedies		Remedies Examples
Drill Failure	Excessive Wear on Cutting Edge	Cutting Conditions Cutting Fluid	- Use higher cutting speeds. - Increase feed rates.  - Reduce pressure if using internal coolant. - Use cutting fluid with more lubricity.	- $V_c = 80-100$ m/min - Refer to recommended cutting conditions listed in the general catalogue.  - Below 1,5 MPa.
	Chisel Point Chipping	Tool Design Cutting Conditions Others	- Increase size of chisel width. - Increase amount of honing on cutting edge.  - Reduce depth-of cut. - Reduce feed rate at entry point.  - Improve workpiece clamping rigidity.	- $f = 0,05-0,1$ mm/rev .
	Chipping on Peripheral Cutting Edge	Tool Design Cutting Conditions Cutting Fluid Others	- Increase amount of honing on cutting edge. - Reduce the amount of front flank angle. - Reduce cutting speeds. - Increase feed rates.  - Use cutting fluid with more lubricity. - Improve workpiece clamp rigidity.	- Refer to recommended cutting conditions listed in the general catalogue.
	Margin Wear	Tool Design Cutting Conditions Cutting Fluid Others	- Increase amount of back taper. - Reduce margin width. - Reduce cutting speeds. - Increase feed rates.  - Use cutting fluid with more lubricity. - Schedule for earlier regrind.	- Refer to recommended cutting conditions listed in the general catalogue.
	Drill Breakage	Tool Design Cutting Conditions Cutting Fluid Others	- Increase amount of back taper. - Reduce margin width. - Reduce cutting speeds.  - Use cutting fluid with more lubricity. - Improve workpiece clamp rigidity.	- Refer to recommended cutting conditions listed in the general catalogue.
Unsatisfactory Hole Accuracy	Oversized Holes	Tool Design Cutting Conditions Cutting Fluid Others	- Improve overall drill rigidity. (large web, small flute). - Reduce drill point angle.  - Reduce feed rate at entry phase. - Reduce cutting speeds.  - Improve workpiece clamp rigidity. - Improve drill clamp precision. - Improve drill clamp rigidity.	- $130^\circ-120^\circ$  - $f = 0,05-0,1$ mm/rev - Refer to recommended cutting conditions listed in the general catalogue.  - Drill run-out below 0,02 mm
	Poor Surface Finish	Tool Design Cutting Conditions Cutting Fluid	- Increase amount of back taper.  - Increase cutting speeds.  - Use cutting fluid with more lubricity.	- Refer to recommended cutting conditions listed in the general catalogue.
	Holes are Not Straight	Tool Design Cutting Conditions Others	- Reduce amount of edge honing.  - Reduce feedrates.  - Improve workpiece clamp rigidity. - Improve drill clamp precision. - Improve drill clamp rigidity.	- Refer to recommended cutting conditions listed in the general catalogue.  - Drill run-out below 0,02 mm
Unsatisfactory Chip Control	Packing of Chips	Cutting Conditions Cutting Fluid	- Increase cutting speeds. - Increase feed rates.  - Reduce pressure if using internal coolant.	- Refer to recommended cutting conditions listed in the general catalogue.  - Below 1,5 MPa.
	Long Stringy Chips	Tool Design Cutting Conditions Cutting Fluid	- Reduce amount of edge honing.  - Increase feed rates.  - Reduce pressure if using internal coolant.	- Refer to recommended cutting conditions listed in the general catalogue.  - Below 1,5 MPa.

## Application Map of the Various Tool Materials

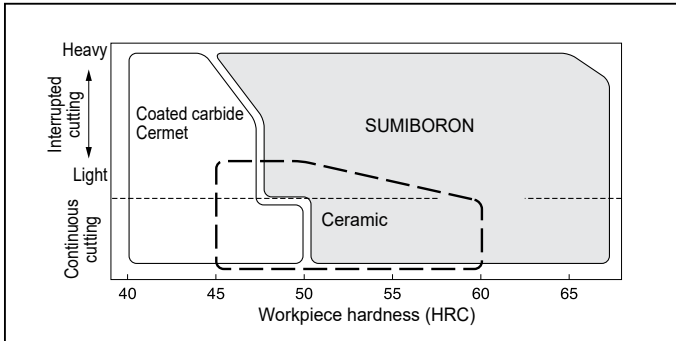

## Work Materials and Cutting Speed Recommendations

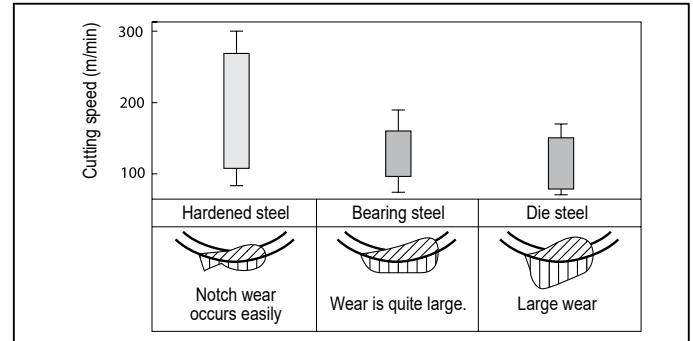

## Influence of Coolant on Tool Life

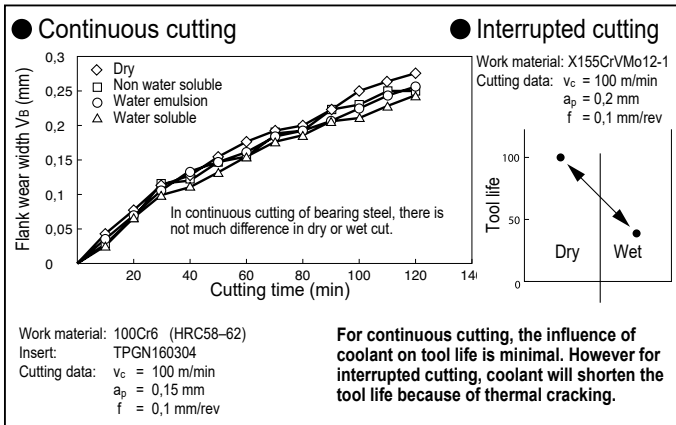

## Relation Workpiece Hardness and Cutting Forces

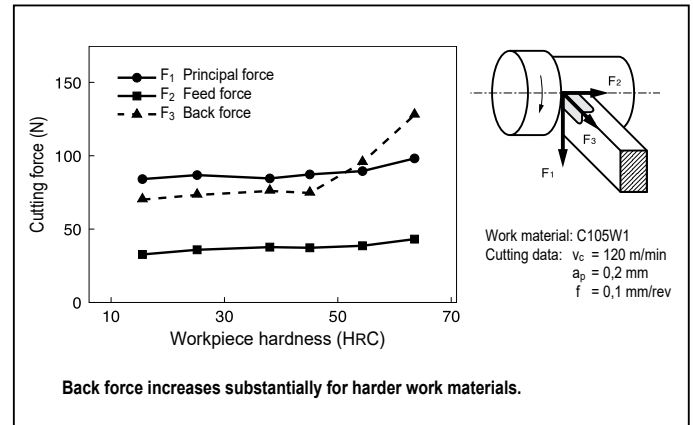

## Relation between Flank Wear and Cutting Force

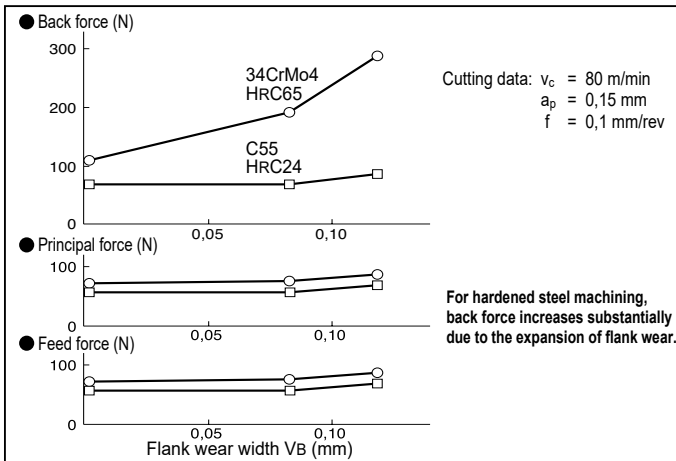

## Workpiece Hardness on Cutting Force and Accuracy

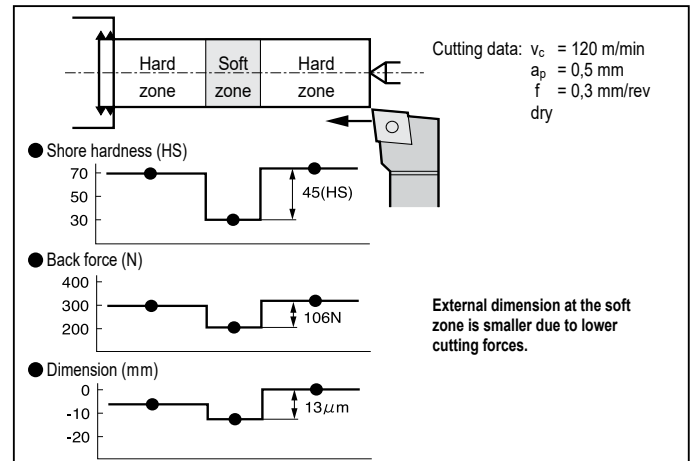

## Relation Cutting Speed and Surface Roughness

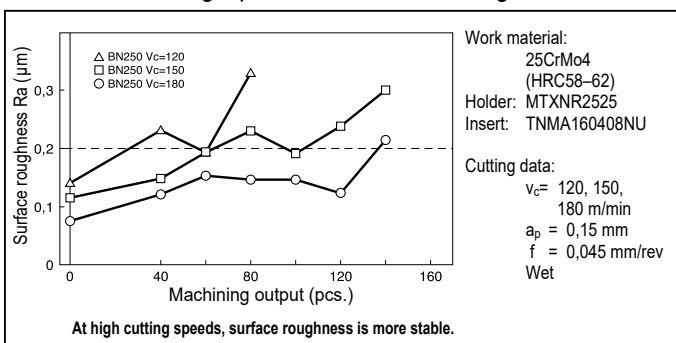

## Improvement of Surface Roughness by Altering the Feedrate

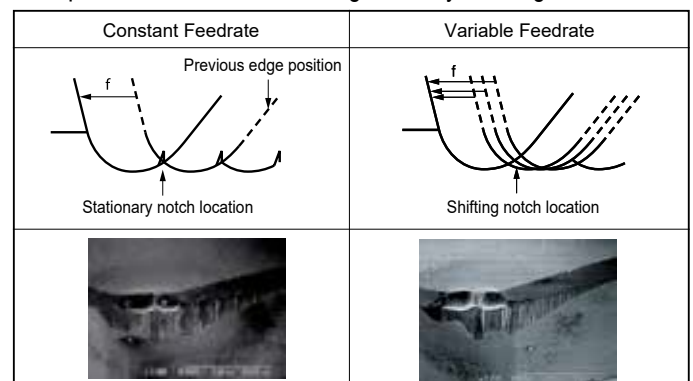

Varying the feedrate spreads the notch location over a larger area, surface finish improves and notch wear decreases.

## Advantages of Using SUMIBORON for Cast Iron Machining

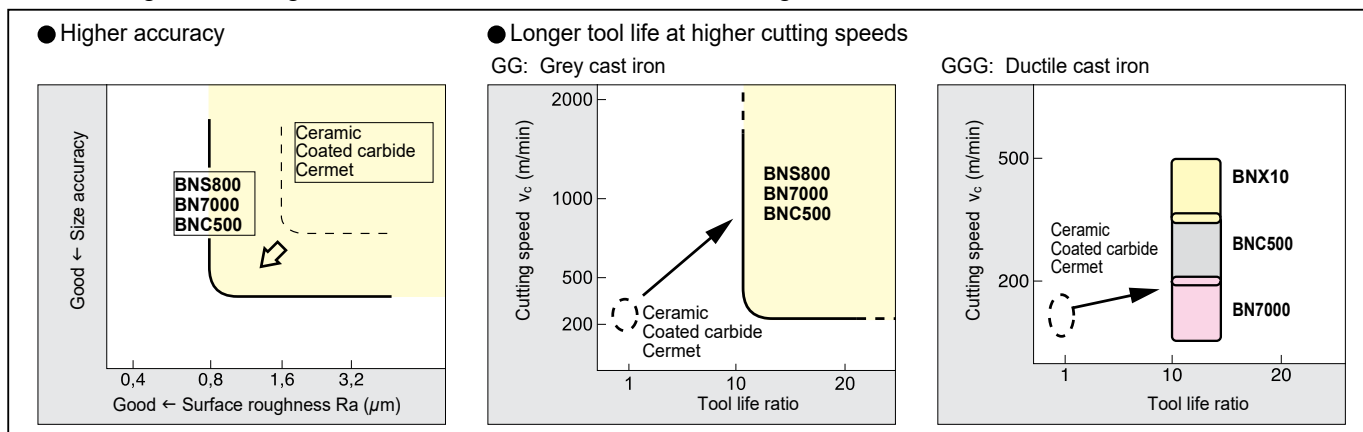

## Turning

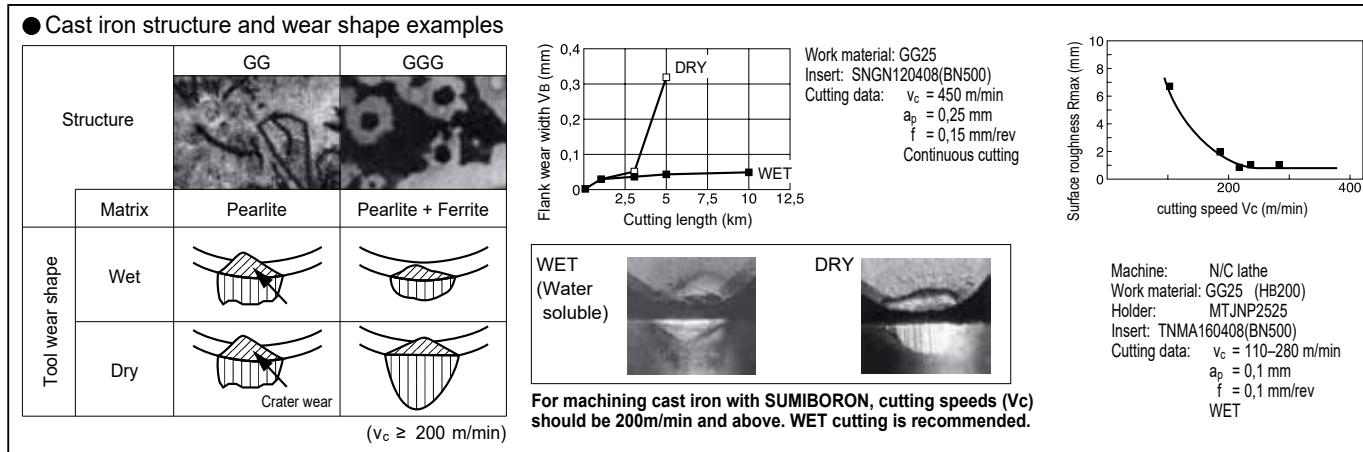

## Milling

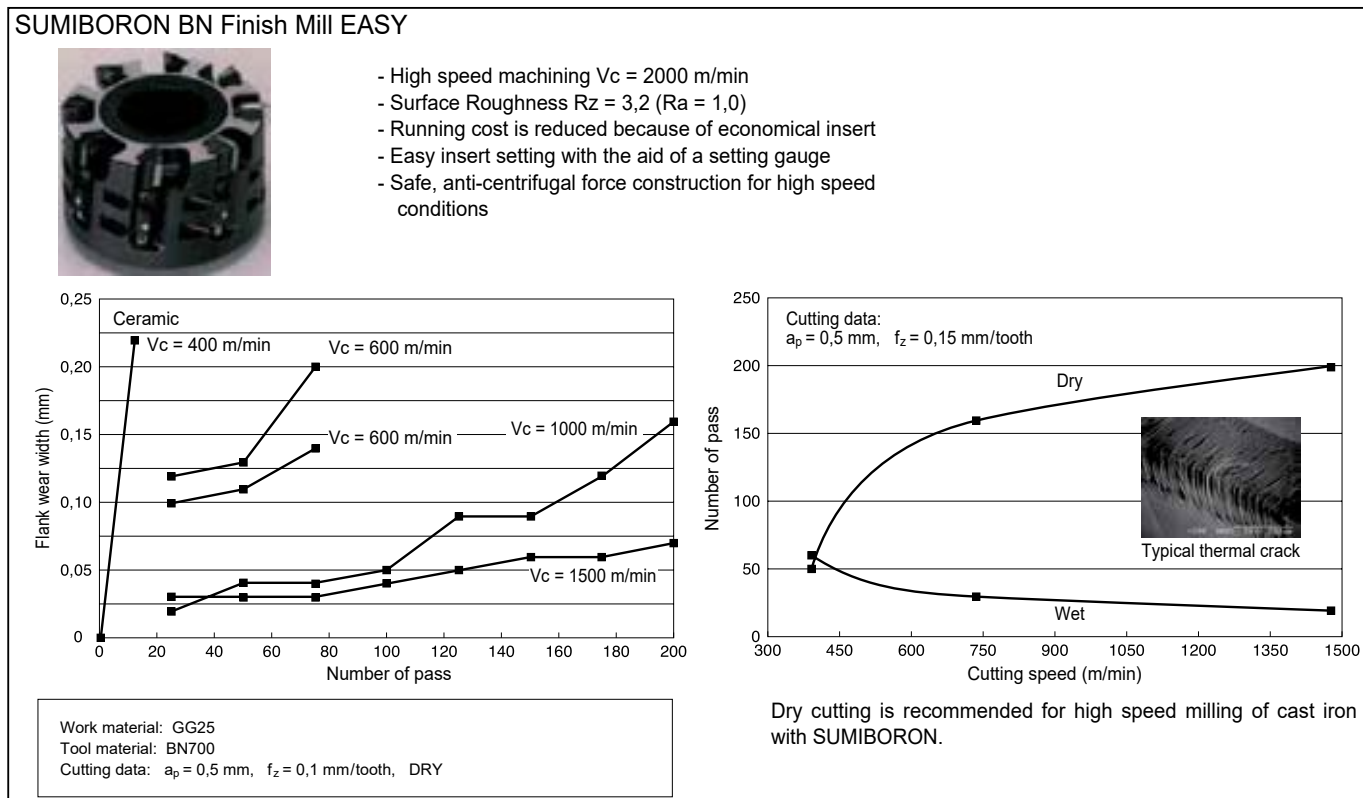

■ Powder Metal

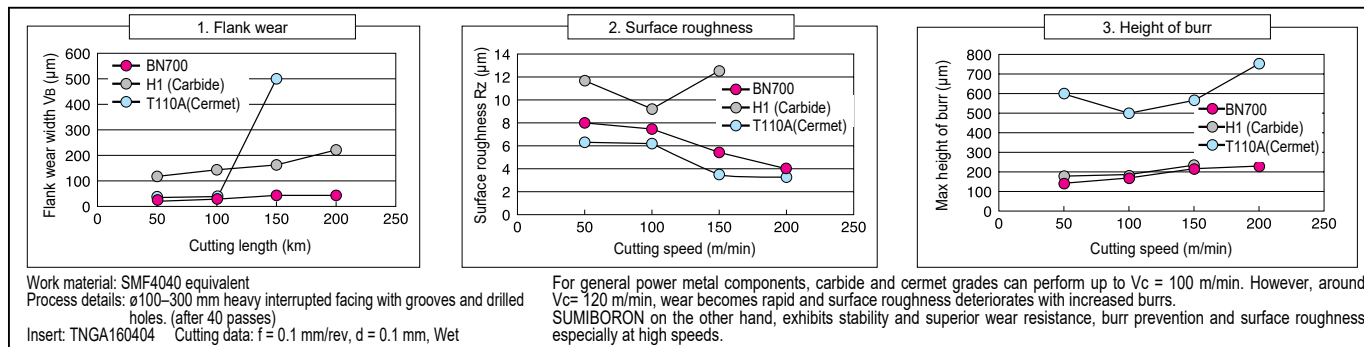

■ Heat Resistant Alloy

● Ni based alloy

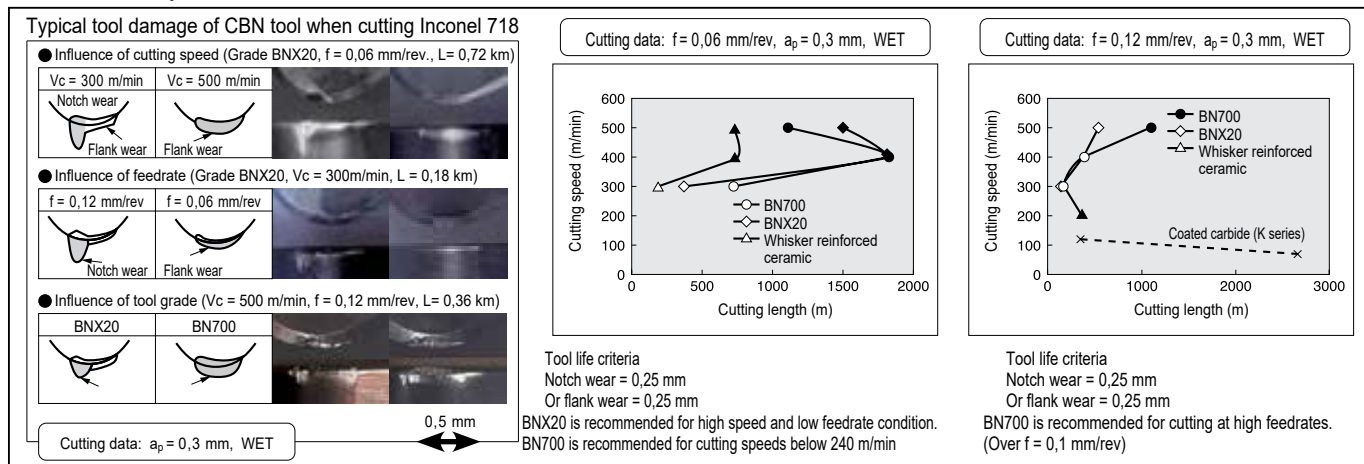



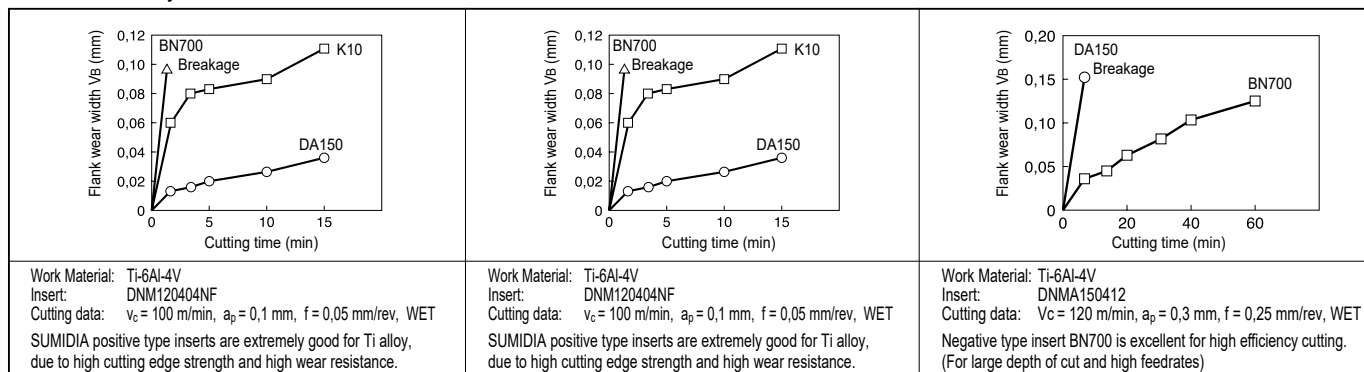



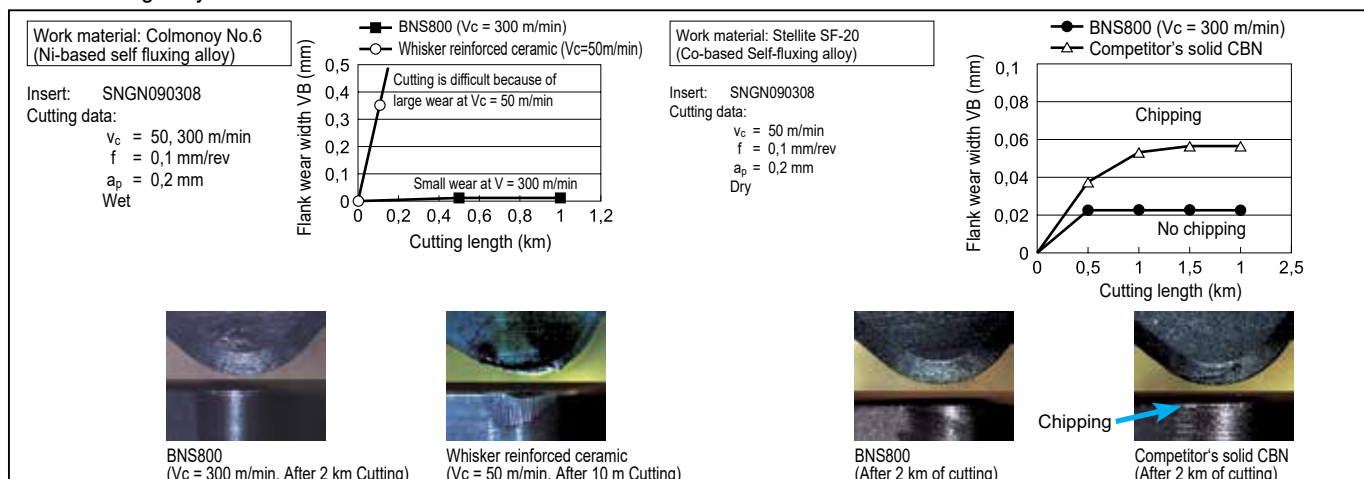

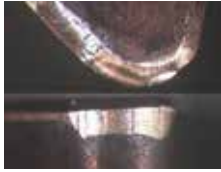
● Ti based alloy



● Hard facing alloys



		Damage	Remedies
Cutting Edge Failure	Large flank wear		<p>Tool material</p> <p>Tool design</p> <p>Cutting condition</p> <ul style="list-style-type: none"> <li>- Select a more wear resistant grade.</li> <li>- Reduce the cutting force.</li> <li>- Reduce the NL width and angle.</li> <li>- Positive inserts preferred</li> <li>- Check the cutting speed.</li> <li>- Reduce the cutting speed to less than 200 m/min.</li> <li>- Higher feed rate reduces the overall tool-to-work contact time.</li> </ul>
	Large crater wear		<p>Tool material</p> <p>Tool design</p> <p>Cutting condition</p> <ul style="list-style-type: none"> <li>- Crater wear resistant grades are recommended.</li> <li>- Continuous ~ Light interrupted cutting = BNC2010</li> <li>- Light ~ Medium interrupted cutting = BNX20</li> <li>- Medium ~ Heavy interrupted cutting = BNX25</li> <li>- Determine the cutting edge geometry after inspecting the used inserts closely.</li> <li>- Sharpen the cutting edge to prevent crater wear.</li> <li>- Strengthen the cutting edge to prevent crater breakage.</li> <li>- Check the cutting speed.</li> <li>- Reduce the cutting speed to less than 200 m/min.</li> <li>- Higher feed rates are recommended.</li> </ul>
	Breakage at bottom of crater		
	Flaking		<p>Tool material</p> <p>Tool design</p> <p>Cutting condition</p> <ul style="list-style-type: none"> <li>- Flaking is caused by high back forces and back force is related to flank wear.</li> <li>- Select a more wear resistant grade.</li> <li>- A sharper cutting edge helps prevent flaking.</li> <li>- Reduce the NL angle and width</li> <li>- Positive inserts preferred</li> <li>- Reduce flank wear with lower speed and higher feed rates.</li> <li>- Reducing tool-to-work contact time effectively reduces flank wear.</li> </ul>
	Chipping at notch position		<p>Cutting condition</p> <ul style="list-style-type: none"> <li>- If surface finish is affected, consider using the "Variable Feed rate" method to improve finishing.</li> <li>- For other cases, use remedies similar to that for normal wear.</li> </ul>
	Chipping at notch position		<p>Tool material</p> <p>Tool design</p> <p>Cutting condition</p> <ul style="list-style-type: none"> <li>- Caused by impact shocks to the cutting edge.</li> <li>- Chattering may also be a contributing factor.</li> <li>- Select a tougher grade.</li> <li>- Strengthen the cutting edge.</li> <li>- Large NL angle, Honing.</li> <li>- Higher feed rates are recommended to lessen the number of impacts.</li> </ul>
	Chipping at nose position		<p>Tool material</p> <p>Tool design</p> <p>Cutting condition</p> <ul style="list-style-type: none"> <li>- Caused by impact shocks to the cutting edge.</li> <li>- Chattering may also be a contributing factor.</li> <li>- Select a tougher grade.</li> <li>- Strengthen the cutting edge.</li> <li>- Large NL angle, Honing.</li> <li>- Higher feedrates are recommended to lessen the number of impacts.</li> </ul>
	Thermal crack		<p>Cutting condition</p> <p>Tool design</p> <p>Tool material</p> <ul style="list-style-type: none"> <li>- Thermal shocks generate vertical crack lines across the cutting edge.</li> <li>- Completely dry condition is recommended.</li> <li>- If dry condition machining is already observed, then reduction of cutting temperatures and cutting force is necessary.</li> <li>- Decrease cutting speed, feedrate, depth of cut.</li> <li>- Sharpen cutting edge.</li> <li>- Select more thermal conductivity grade.</li> </ul>

## ■ Steel and Non-Ferrous Metal Symbols Chart

### ● Carbon Steels

JIS	AISI	DIN
S10C	1010	C10
S15C	1015	C15
S20C	1020	C22
S25C	1025	C25
S30C	1030	C30
S35C	1035	C35
S40C	1040	C40
S45C	1045	C45
S50C	1049	C50
S55C	1055	C55

### ● Ni-Cr-Mo Steels

JIS	AISI	DIN
SNCM220	8620	21NiCrMo2
SNCM240	8640	—
SNCM415	—	—
SNCM420	4320	—
SNCM439	4340	40NiCrMo6
SNCM447	—	34NiCrMo6

### ● Cr Steels

JIS	AISI	DIN
SCr415	—	15CrMo5
SCr420	5120	20Cr4
SCr430	5130	34Cr4
SCr435	5132	37Cr4
SCr440	5140	41Cr4
SCr445	5147	—

### ● Cr-Mo Steels

JIS	AISI	DIN
SCM415	—	15CrMo5
SCM420	—	20CrMo5
SCM430	4131	25CrMo4
SCM435	4137	34CrMo4
SCM440	4140	42CrMo4
SCM445	4145	—

### ● Mn Steels and Mn-Cr Steels for Structural Use

JIS	AISI	DIN
SMn420	1522	—
SMn433	1534	—
SMn438	1541	—
SMn443	1541	—
SMnC420	—	—
SMnC443	—	—

### ● Cr-Mo Steels

JIS	AISI	DIN
SK1	—	—
SK2	W1-11 1/2	—
SK3	W1-10	C105W1
SK4	W1-9	—
SK5	W1-8	C80W1
SK6	—	C80W1
SK7	—	C70W2

### ● High Speed Steels

JIS	AISI	DIN
SKH2	T1	—
SKH3	T4	S18-1-2-5
SKH10	T15	S12-1-4-5
SKH51	M2	S6-5-2
SKH52	M3-1	—
SKH53	M3-2	S6-5-3
SKH54	M4	—
SKH56	M36	—

### ● Alloy Tool Steels

JIS	AISI	DIN
SKS11	F2	—
SKS51	L6	—
SKS43	W2-9 1/2	—
SKD1	D3	X210Cr12
SKD11	D2	X155CrVMo12-1
SKD61	—	X40CrVMo5-1

### ● Grey Cast Iron

JIS	AISI	DIN
FC100	No 20B	GG-10
FC150	No 25B	GG-15
FC200	No 30B	GG-20
FC250	No 35B	GG-25
FC300	No 45B	GG-30
FC350	No 50B	GG-35

### ● Nodular Cast Iron

JIS	AISI	DIN
FCD400	60-40-18	GGG-40
FCD450	—	GGG-40.3
FCD500	80-55-06	GGG-50
FCD600	—	GGG-60
FCD700	100-70-03	GGG-70

### ● Ferritic Stainless Steels

JIS	AISI	DIN
SUS405	405	X10CrAl13
SUS429	429	—
SUS430	430	X6Cr17
SUS430F	430F	X7CrMo18
SUS434	434	X6CrMo17 1

### ● Martensitic Stainless Steels

JIS	AISI	DIN
SUS403	403	—
SUS410	410	X10Cr13
SUS416	416	—
SUS420JI	420	X20Cr13
SUS420F	420F	—
SUS431	431	X20CrNi17 2
SUS440A	440A	—
SUS440B	440B	—
SUS440C	440C	—

### ● Austenitic Stainless Steels

JIS	AISI	DIN
SUS201	201	—
SUS202	202	—
SUS301	301	X12CrNi17 7
SUS302	302	—
SUS302B	302B	—
SUS303	303	X10CrNiS18 9
SUS303Se	303Se	—
SUS304	304	X5CrNiS18 10
SUS304L	304L	X2CrNi19 11
SUS304NI	304N	—
SUS305	305	X5CrNi18 12
SUS308	308	—
SUS309S	309S	—
SUS310S	310S	—
SUS316	316	X5CrMo17 12 2
SUS316L	316L	X2CrNiMo17 13 2
SUS316N	316N	—
SUS317	317	—
SUS317L	317L	X2CrNiMo18 16 4
SUS321	321	X6CrNiTi18 10
SUS347	347	X6CrNiNb18 10
SUS384	384	—

### ● Heat Resisting Steels

JIS	AISI	DIN
SUH31	—	—
SUH35	—	—
SUH36	—	X53CrMnNi21 9
SUH37	—	—
SUH38	—	—
SUH309	309	—
SUH310	310	CrNi2520
SUH330	N08330	—

### ● Ferritic Heat Resisting Steels

JIS	AISI	DIN
SUH21	—	CrAl1205
SUH409	409	X6CrTi12
SUH446	446	—

### ● Martensitic Heat Resisting Steels

JIS	AISI	DIN
SUH1	—	X45CrSi9 3
SUH3	—	—
SUH4	—	—
SUH11	—	—
SUH600	—	—



# References

Expansion

## Steel and Non-Ferrous Metal Symbols Chart

### P Carbon Steel for Structural Use

JIS	AISI/ASTM	DIN/EN	GB	BS	AFNOR	ГОСТ
S10C	1008 1010	C10E C10R 1.1122	08 10	040A10 045A10 045M10	XC10	08 10
S12C	1012	—	—	040A12	XC12	—
S15C	1015	C15E C15R 1.1132	15	055M15	—	15
S20C	1020	C22 CK22	20	070M20	—	20
S25C	1025	C25 C25E C25R C16D 1.0415	25	—	—	25
S30C	1030	C30 C30E C30R	30	080A30 080M30	—	30
S35C	1035	C35 C35E C35R 1.1172	35	080A35 080M36	—	35
S40C	1040 C40E	C40 C40E C40R 1.1186	40	060A40 080A40 080M40	—	40
S43C	1042 1043	—	—	080A42	XC42H1 XC42H2	40Г
S45C	1045 1045H	C45 C45E C45R 1.1191 1.1192	45	060A45 080M46	XC45	45
S50C	1049	C50 C50E C50R 1.1206	50	080M50	XC50	50
S53C	1050 1053	—	50Mn	080A52	XC54	—
S55C	1055	C55 C55E C55R 1.1203	55	070M55	XC55H1 XC55H2	55
S58C	1060	C60 C60E C60R	60	060A57 080A57	XC60	—
S60C	1059	C60E 1.1221	60 60Mn	—	—	60
S09CK	1010	C10E C10R	—	045A10 045M10	XC10	—
S15CK	1015	C15E C15R	—	—	XC12	—
S20CK	—	CK22	—	—	XC18	—

### P Cr-Mo Steel

JIS	AISI/ASTM	DIN/EN	GB	BS	AFNOR	ГОСТ
SCM415	—	18CrMo4 1.7243	15CrMo	—	—	15XM
SCM420	—	20MoCr4 1.7321	20CrMo	708M20	—	20XM
SCM421	4121	18CrMo4 22CrMoS35 1.7243	20CrMn- Mo	—	—	25XFM
SCM425	—	25CrMo 1.7218	25CrMo	—	—	—
SCM430	4130	—	30CrMo	708A30	30CD4	30XM
SCM435	4135 4137	34CrMo4 1.7220	35CrMo	708A37 709A37	34CD4 38CD4 35CD4	35XM
SCM440	4142 4140	42CrMo4 42CrMoS4 1.7225	42CrMo	708M40 708A40 708A42 709A42 709M40	42CD4	38XM
SCM445	4145 4150	50CrMo4 1.7228	50CrMo	708A47	—	—

### P Manganese Chromium Steel/Manganese Steel

SMn420	1522 1524	18Mn5 1.0436	20Mn2	150M19 120M19	20M5	20Г
SMn433	1330	28Mn6 1.1170	30Mn2	—	—	30Г2
SMn438	1335 1541	—	35Mn2	150M36	40M6	35Г2
SMn443	1340 1345 1541	—	40Mn2 45Mn2	135M40 150M36	35M5	35Г2 45Г2
SMnC420	5120	20MnCr5 1.7147	20CrMn	—	—	18ХГ
SMnC443	5140	41Cr4 1.7035	40CrMn	—	—	—

### P Carbon Tool Steel

SK140 SK1	W2-13A W1-13	—	T13	—	Y <sub>2</sub> 140	—
SK120 SK2	W1-11 1/2	C120U 1.1555	T12	BW1C	Y <sub>2</sub> 120	y12
SK105 SK3	W1-10 W1-10 1/2	C105U 1.1545 C105W1	T11	BW1B	Y <sub>1</sub> 105	—
SK95 SK4	W1-9 W1-9 1/2	C105U 1.1545	T10	BW1A	Y <sub>1</sub> 90 Y <sub>1</sub> 80	y10
SK85 SK5	W1-8C W1-8	C80W1	T8Mn	BW1A	—	y8Г
SK80	W1-8A	C80U 1.1525	T8	—	—	y8
SK70	1070	C70U 1.1520	T7	—	—	y7

# References

## P Cr Steel

JIS	AISI/ASTM	DIN/EN	GB	BS	AFNOR	ГОСТ
SCr415	5115	17Cr3 1.7016	15Cr	—	—	15X
SCr420	5120	—	20Cr	—	20MC5	20X
SCr430	5130 5132	34Cr4 34CrS4 1.7033	30Cr	530A30 530A32	32C4	30X
SCr435	5135	37Cr4 1.7034	35Cr	530A36	38C4	35X
SCr440	5140	41Cr4 41CrS4 1.7035	40Cr	530M40 530A40	42C4	40X
SCr445	5147	—	45Cr	—	—	45X

## P Nickel Chromium Steel

SNC415	4720 4715	20NiCrMo2-2 10NiCr5-4 17CrNi6-6 1.5918 1.5805 1.6523	20CrNi 12CrNi2 15CrNi6K	—	—	20XH 12XH
SNC236	3140 4337	41CrCrMo7-3-2 34CrNiMo6	40CrNi 34CrNi2	—	—	40XH
SNC246	8645	—	45CrNi	—	—	45XH
SNC815	E3310	15NiCr13 1.5752	12CrNi3	—	—	12XH3A
SNC620	—	20NiCrMo13-4 1.6660	20CrNi3	—	—	20XH3A
SNC631	—	30NiCrMo16-6 1.6747	30CrNi3	—	—	30XH3A
SNC836	—	35NiCrMo16 1.6773	37CrNi3	—	—	—

## P Ni-Cr-Mo Steel

SNCM220	8615 8617 8620 8622 4718	20NiCrMo2-2 20NiCrMoS2-2 17NiCrMo6 1.6566 1.6523	20CrNiMo 18CrMnNiMo 20NiCrMoK	805A20 805M20 805A22 805M22	20NCD 2	20XH2M 18XHfM
SNCM240	8637 8640	39NiCrMo3 1.6510	40CrNiMo	—	—	40XH2MA
SNCM415	—	—	—	—	—	—
SNCM420	4320	17NiCrMo6-4	20CrNi2Mo	—	—	20XH2M (20XHM)
SNCM439	4340	41NiCrMo7-3-2 1.6563	40CrNi2Mo	—	—	40XH2MA
SNCM447	4340	41NiCrMo7-3-2 1.6563	45CrNiMoV	—	—	—

## P High Speed Steel

JIS	AISI/ASTM	DIN/EN	GB	BS	AFNOR	ГОСТ
SKH2	T1	HS18-0-1 1.3355	W18Cr4V	BT1	Z80WCV 18-04-01	P18
SKH3	T4	S18-1-2-5	—	BT4	Z80WKCV 18-05-04-01	—
SKH4	T5	—	—	BT5	Z80WKCV 18-10-04-02	—
SKH10	T15	S12-1-4-5	W12Cr4V5Co5	BT15	Z160WKCV 12-05-05-04	P12K5V5
SKH51	M2	S6-5-2 1.3339	W6Mo5Cr4V2	BM2	Z160WDCV 06-05-04-02	P6M5ø2
SKH52	M3-1	HS6-6-2 1.3350	W6Mo6Cr4V2	—	—	—
SKH53	M3-2	S6-5-3 HS6-5-3 1.3344	W6Mo5Cr4V3	—	Z160WDCV 06-05-04-03	P6M5ø3
SKH54	M4	—	W6Mo5Cr4V4	BM4	Z130WDCV 06-05-04-04	—
SKH55	M35 M41	S6-5-2-5 HS6-5-2-5 1.3243	W6Mo5Cr4V2Co5	BM35	Z190WDCV 06-05-05-04-02	P6M5K5
SKH56	M36	—	—	—	—	—
SKH57	M48	HS10-4-3-10 1.3207	W10Mo4Cr4V3Co10	—	Z130WKCDV 10-10-04-04-03	—
SKH58	M7	HS2-8-2 1.3348	W2Mo9Cr4V2	—	Z100DCWV 09-04-02-02	—
SKH59	M42	HS2-10-1-8 1.3247	W2Mo9Cr4VCo8	BM42	Z130DKCWV 09-08-04-02-01	P2M9K8ø

## P Alloy Tool Steel

SKS11	F2	—	—	—	—	—
SKS2	—	105WCr6	—	—	105WC13	—
SKS51	L6	—	—	—	—	—
SKS41	—	—	4CrW2Si	—	—	4XB2C
SKS43	W2-9 1/2	—	—	BW2	Y1105V	—
SKS44	W2-8 1/2	—	—	—	—	—
SKS3	O1	95MnWCr5 1.2825	9CrWMn	—	—	9XBf
SKS31	O7	105WCr6	CrWMn	—	105WC31	XBf
SKD1	D3	X210Cr12 1.2080	Cr12	BD3	X200Cr12	X12
SKD4	—	—	30W4Cr2V	BH21	Z32WCV5	—
SKD5	H21	X30WCrV9-3 1.2581	3Cr2W8V	BH21	Z30WCV9	3X2B8ø
SKD6	H11	X37CrMoV5-1 1.2343	4Cr5MoSiV	BH11	X38CrMoV5	4X5MøC
SKD61	H13	X40CrMoV5-1 1.2344	4Cr5MoSiV1	BH13	Z40CDV5	4X5Mø1C
SKD7	H10	X32CrMoV33 1.2365	3Cr3Mo3V	BH10	32DCV28	—
SKD8	H19	38CrCoWV18-17-17 1.2661	3Cr3Mo3VCo3	BH19	—	—
SKD10	D2	X153CrMoV12 1.2379	Cr12Mo1V1	—	—	X12M1ø1
SKD11	D2 D4	—	Cr12MoV	BD2	X160CrMoV12	X12Mø
SKD12	A2	X100CrMoV5 1.2363	Cr5Mo1V	BA2	Z100CDV5	—

# References

Expansion

## ■ Steel and Non-Ferrous Metal Symbols Chart

### M Ferritic Stainless Steels

JIS	AISI/ASTM	DIN/EN	GB	BS	AFNOR	ГОСТ
SUS405	405 S40500	X10CrAl13 1.4002	0Cr13Al 06Cr13Al	405S17	26CA13	—
SUS429	429 S42900	—	1Cr15 10Cr15 022Cr15NbTi	—	—	—
SUS430	430 S43000	X6Cr17 1.4016	1Cr17 10Cr15 S11710	430S17	Z8C17	12X17
SUS430F	430F S43020	X12CrMoS17	Y1Cr17 Y10Cr17	—	Z10CF17	—
SUS434	434 S43400	X6CrMo17-1 1.4113	1Cr17Mo 10Cr17Mo	434S17	Z8CD17.01	—

### M Martensitic Stainless Steels

JIS	AISI/ASTM	DIN/EN	GB	BS	AFNOR	ГОСТ
SUS410	410 S41010	X10Cr13 1.4006	12Cr13 1Cr13	410S21	Z13C13	12X13
SUS403	403 S40300	—	12Cr12 1Cr12	—	—	—
SUS444	444 S44400	X2CrMoTi18-2 1.4521	019Cr19Mo2NbTi 00Cr18Mo2	—	—	—
SUS416	416 S41600	X12CrS13 1.4005	Y12Cr13 Y1Cr13	416S21	Z12CF13	—
SUS420J1	420 S42000	X20Cr13 1.4021	20Cr13 2Cr13	420S29	Z20C13	20X13
SUS420J2	420 S42000	X30Cr13 1.4028	30Cr13 3Cr13	420S45	Z30C13	30X13
SUS420F	420G S42020	X29Cr13 1.4029	Y30Cr13 Y3Cr13	—	Z30CF13	—
SUS431	431 S43100	X17CrNi16-2	17Cr16Ni2	431S29	—	—
SUS440C	440C S44004	—	108Cr17 11Cr17	—	Z100CD17	—

### M Stainless Steel (Precipitation Hardened Structure)

JIS	AISI/ASTM	DIN/EN	GB	BS	AFNOR	ГОСТ
SUS630	630 S17400	X5CrNiCuNb16-4 1.4542	0Cr17Ni4Cu4Nb 06Cr17Ni4Cu4Nb	—	Z6CNU17.04	—
SUS631	631 S17700	X7CrNiAl17-7 1.4568	0Cr17Ni7Al 07Cr17Ni7Al	—	Z8CNA17.07	09X17H7 IO

### M Austenitic Stainless Steels

JIS	AISI/ASTM	DIN/EN	GB	BS	AFNOR	ГОСТ
SUS201	201 S20100	X12CrMnNi17-7-5 1.4372	1Cr17Mn6Ni5N 12Cr17Mn6Ni5N	—	Z12CMN17-07Az	—
SUS202	202 S20200	X12CrMnNi18-9-5 1.4373	1Cr18Mn9Ni5N 12Cr18Mn9Ni5N	284S16	—	—
SUS301	301 S30100	X12CrNi17 7 1.4319 1.4310	1Cr17Ni7 12Cr17Ni7	—	Z12CN17.07	17X18H9
SUS302	302 S30200	X9CrNi18-9 1.4325	1Cr18Ni9 12Cr18Ni9	302S25	Z10CN18.09	12X18H9
SUS302B	302B S30215	—	1Cr18Ni9Si3 12Cr18Ni9Si3	—	—	—
SUS303	303 S30300	X8CrNi18-9 X10CrNiS189 1.4305	Y1Cr18Ni9 Y12Cr18Ni9	303S21	Z10CNF18.09	—
SUS303Se	303Se S30323	—	Y12Cr18Ni9Se Y1Cr18Ni9Se	303S41	—	12X18H10E
SUS304	304 S30400	X5CrNi18-10 1.4301	0Cr18Ni9 06Cr19Ni10	304S31	Z6CN18.09	08X18H10
SUS304L	304L S30403	X2CrNi19-11 1.4306	00Cr19Ni10 022Cr19Ni10	304S11	Z2CN18.10	03X18H11
SUS304N1	304N S30451	X5CrNiN19-9 1.4315	06Cr19Ni10N 06Cr19Ni10NbN	—	Z6CN19-09Az	—
SUS305	305 S30500	X2CrNiN18-10 1.4311	1Cr18Ni12 10Cr18Ni12	305S19	Z8CN18.12	—
SUS309S	309S S30908	X6CrNi23-13 1.4950	0Cr23Ni13 06Cr23Ni13	—	—	0X23H12
SUS310S	310S S31008	X6CrNi25-20 1.4951	0Cr25Ni20 06Cr25Ni20	—	—	08X23H20
SUS316	316 S31600	X5CrNiMo17-12-2 1.4401	0Cr17Ni12Mo2 06Cr17Ni12Mo2	316S31	Z7CND17.12	—
SUS316L	316L S31603	X2CrNiMo17-12-2 1.4404	00Cr17Ni12Mo2 022Cr17Ni12Mo2	316S11	Z2CND17.12	03X17H14M2
SUS316N	316N S31651	—	0Cr17Ni12Mo2N 06Cr17Ni12Mo2N	—	—	—
SUS317	317 S31700	—	0Cr19Ni13Mo3 06Cr19Ni13Mo3	317S16	—	—
SUS317L	317L S31703	X2CrNiMo18-15-4 1.4438	00Cr19Ni13Mo3 022Cr19Ni13Mo3	317S12	Z2CND19.15	03X19H13M3
SUS321	321 S32100	X6CrNiTi18-10 1.4541	0Cr18Ni10Ti 06Cr18Ni10Ti	321S31	Z6CNT18.10	08X18H10T
SUS347	347 S34700	X6CrNiNb18-10 1.4550	0Cr18Ni11Nb 06Cr18Ni11Nb	347S31	Z6CNNb18.10	08X18H12B

## S Ferritic Heat Resistant Steels

JIS	AISI/ASTM	DIN/EN	GB	BS	AFNOR	ГОСТ
SUH409	409 S40900	X6CrTi12	06Cr11Ti 0Cr11Ti	409S19	Z6CT12	—
SUH446	446 S44600	—	2Cr25N 16Cr25N	—	Z12C24	—

## S Martensitic Heat Resistant Steel

JIS	AISI/ASTM	DIN/EN	GB	BS	AFNOR	ГОСТ
SUH1	—	—	45Cr9Si3	401S45	Z45CS9	—
SUH3	—	—	4Cr10Si2Mo 40Cr10Si2Mo	—	Z40CSD10	40X10C2M
SUH4	—	—	8Cr20Si2Ni 80Cr20Si2Ni	443S65	Z80CSN20.02	—
SUH11	—	—	4Cr9Si2 42Cr9Si2	—	—	40X 9C2
SUH600	—	—	2Cr12MoVNbN 18Cr12MoVNbN	—	—	—
SUH616	616 S42200	—	2Cr12NiMoWV 22Cr12NiWMoV	—	—	—

## S Austenitic Heat Resistant Steel

JIS	AISI/ASTM	DIN/EN	GB	BS	AFNOR	ГОСТ
SUH31	—	—	4Cr14Ni14W2Mo	331S42	—	45X14H14B2M
SUH35	—	X53CrMnNi21-9-4 1.4871	5Cr21Mn9Ni4N 53Cr21Mn9Ni4N	349S52	Z52CMN21.09	55X20F9AH4
SUH36	—	X53CrMnNi21 9	—	349S54	Z55CMN21-09Az	55X20F9AH4
SUH37	—	X15CrNiSi20-12 1.4828	22Cr21Ni12N 2Cr21Ni12N	381S34	—	—
SUH38	—	—	—	—	—	—
SUH309	309 S30900	X12CrNi23-13 1.4833	16Cr23Ni13 2Cr23Ni13	309S24	Z15CN24.13	20X23H12
SUH310	310 S31000	—	2Cr25Ni21 20Cr25Ni20	310S24	Z15CN25.20	—
SUH330	—	X12CrNiMoZn25-18-6-5 1.4565	1Cr16Ni35 12Cr16Ni35	—	Z12NCS35.16	—

## K Gray Cast Iron

JIS	AISI/ASTM	DIN/EN	GB	BS	AFNOR	ГОСТ
FC100	No 20B	GG-10	HT100	100	—	Cy10
FC150	No 25B	GG-15	HT150	150	FGL150	Cy15
FC200	No 30B	GG-20	HT200	200	FGL200	Cy20
FC250	No 35B	GG-25	HT250	250	FGL250	Cy25
FC300	No 45B	GG-30	HT300	300	FGL300	Cy30
FC350	No 50B	GG-35	HT350	350	FGL350	Cy35

## K Nodular Cast Iron

JIS	AISI/ASTM	DIN/EN	GB	BS	AFNOR	ГОСТ
FCD400	60-40-18	GGG-40	QT400-18	400/17	FGS370-17	By40
FCD450	—	GGG-40.3	QT450-10	420/12	FGS400-12	By45
FCD500	80-55-06	GGG-50	QT500-7	500/7	FGS500-7	By50
FCD600	—	GGG-60	QT600-3	600/7	FGS600-2	By60
FCD700	100-70-03	GGG-70	QT700-2	700/2	FGS700-2	By70
FCD800	120-90-02	GGG-80	—	800/2	FGS800-2	By80

## N Aluminum and Al Alloys - Sheets, plates and strips

JIS	AISI/ASTM	DIN/EN	GB	BS	AFNOR	ГОСТ
A1060P	1060	EN AW-1060	L2	—	—	—
A1050P	1050	A199.50	1A50	—	—	—
A1100P	1100	EN AW-1100	L5-1	—	—	—
A1200P	1200	EN AW-1200	L5	EN AW-1200	EN AW-1200	—
A2014P	2014	EN AW-2014	LD10	EN AW-2014	EN AW-2014	—
A2017P	2017	EN AW-2017	2A11(LY11)	EN AW-2017	EN AW-2017	—
A2219P	2219	EN AW-2219	2A16(LY16)	—	—	—
A2024P	2024	EN AW-2024	2A12(LY12)	EN AW-2024	EN AW-2024	—
A2124P	2124	EN AW-2124	2A12(LY12)	—	—	—
A3003P	3003	EN AW-3003	LF21	EN AW-3003	EN AW-3003	—
A3004P	3004	EN AW-3004	3004	—	—	—
A3005P	3005	EN AW-3005	3005	—	—	—
A3015P	3105	EN AW-3105	3105	—	—	—
A5005P	5005	EN AW-5005	5005	—	—	—
A5050P	5050	EN AW-5050	—	—	—	—
A5052P	5052	EN AW-5052	5A02	EN AW-5052	EN AW-5052	—
A5154P	5154	—	LF3	—	—	—
A5254P	5254	—	LF3	—	—	—
A5454P	5454	EN AW-5454	5454	EN AW-5454	EN AW-5454	—
A5456P	5456	EN AW-5456	—	—	—	—
A6101P	6101	EN AW-6101	6101	—	—	—
A6061P	6061	EN AW-6061	6061(LD30)	EN AW-6061	EN AW-6061	—
A7075P	7075	EN AW-7075	7A04	EN AW-7075	EN AW-7075	—
A7178P	7178	EN AW-7178	7A03(LC3)	—	—	—

## N Aluminum Alloy Die Castings

JIS	AISI/ASTM	DIN/EN	GB	BS	AFNOR	ГОСТ
ADC1	A413.0	EN AC-44300	YL102	—	—	—
ADC3	A360.0	EN AC-43400	YL104	EN AC-43400	EN AC-43400	—
ADC5	518.0	—	Al-Mg7	—	—	—
ADC10	—	EN AC-46000	YL112	—	—	—
ADC12	—	—	YL113	LM20	—	—
ADC14	B390.0	—	—	—	—	—
AC4C	357	G-AISI7Mg	ZAlSi7Mg1A	LM25	A-S7G-03	—
AC4CH	356	G-AISI7Mg	ZAlSi7Mg	LM25	A-S7G	—
—	308	G-AISI6Cu4	ZAlSi6Cu6Mg	LM21	—	—

## H Hardened Steel

JIS	AISI/ASTM	DIN/EN	GB	BS	AFNOR	ГОСТ
C4BS	440A	X100CrMo13	7Cr17	—	—	—
AC4A	610	X110CrMoV15	—	—	—	—
AC4A	0-2	X65CrMo14	—	—	—	—

# References

## ■ Hardness Scale Comparison Chart

● Approx. metric value and Brinell hardness of steel

Brinell Hardness 10mm Ball 3.000kgf (HB)	Rockwell Hardness				Vickers Hardness 50kgf (HV)	Shore Hardness (HS)	Traverse Rupture Strength (N/mm <sup>2</sup> )
	„A“ Scale Diamond, brale 60kgf (HRA)	„B“ Scale 100kgf 1/10" Ball (HRB)	„C“ Scale Diamond, brale 150kgf (HRC)	„D“ Scale Diamond, brale 100kgf (HRD)			
—	85,6	—	68,0	76,9	940	97	—
—	85,3	—	67,5	76,5	920	96	—
—	85,0	—	67,0	76,1	900	95	—
767	84,7	—	66,4	75,7	880	93	—
757	84,4	—	65,9	75,3	860	92	—
745	84,1	—	65,3	74,8	840	91	—
733	83,8	—	64,7	74,3	820	90	—
722	83,4	—	64,0	73,8	800	88	—
712	—	—	—	—	—	—	—
710	83,0	—	63,3	73,3	780	87	—
698	82,6	—	62,5	72,6	760	86	—
684	82,2	—	61,8	72,1	740	—	—
682	82,2	—	61,7	72,0	737	84	—
670	81,8	—	61,0	71,5	720	83	—
656	81,3	—	60,1	70,8	700	—	—
653	81,2	—	60,0	70,7	697	81	—
647	81,1	—	59,7	70,5	690	—	—
638	80,8	—	59,2	70,1	680	80	—
630	80,6	—	58,8	69,8	670	—	—
627	80,5	—	58,7	69,8	667	79	—
601	79,8	—	57,3	68,7	640	77	—
578	79,1	—	56,0	67,7	615	75	—
555	78,4	—	54,7	66,7	591	73	2055
534	77,8	—	53,5	65,8	569	71	1985
514	76,9	—	52,1	64,7	547	70	1890
495	76,3	—	51,0	63,8	528	68	1820
477	75,6	—	49,6	62,7	508	66	1730
461	74,9	—	48,5	61,7	491	65	1670
444	74,2	—	47,1	60,8	472	63	1585
429	73,4	—	45,7	59,7	455	61	1510
415	72,8	—	44,5	58,8	440	59	1460
401	72,0	—	43,1	57,8	425	58	1390
388	71,4	—	41,8	56,8	410	56	1330
375	70,6	—	40,4	55,7	396	54	1270
363	70,0	—	39,1	54,6	383	52	1220
352	69,3	(110,0)	37,9	53,8	372	51	1180
341	68,7	(109,0)	36,6	52,8	360	50	1130
331	68,1	(108,5)	35,5	51,9	350	48	1095

Brinell Hardness 10mm Ball 3.000kgf (HB)	Rockwell Hardness				Vickers Hardness 50kgf (HV)	Shore Hardness (HS)	Traverse Rupture Strength (N/mm <sup>2</sup> )
	„A“ Scale Diamond, brale 60kgf (HRA)	„B“ Scale 100kgf 1/10" Ball (HRB)	„C“ Scale Diamond, brale 150kgf (HRC)	„D“ Scale Diamond, brale 100kgf (HRD)			
321	67,5	(108,0)	34,3	50,1	339	47	1060
311	66,9	(107,5)	33,1	50,0	328	46	1025
302	66,3	(107,0)	32,1	49,3	319	45	1005
293	65,7	(106,0)	30,9	48,3	309	43	970
285	65,3	(105,5)	29,9	47,6	301	—	950
277	64,6	(104,5)	28,8	46,7	292	41	925
269	64,1	(104,0)	27,6	45,9	284	40	895
262	63,6	(103,0)	26,6	45,0	276	39	875
255	63,0	(102,0)	25,4	44,2	269	38	850
248	62,6	(101,0)	24,2	43,2	261	37	825
241	61,8	100,0	22,8	42,0	253	36	800
235	61,4	99,0	21,7	41,4	247	35	785
229	60,8	98,2	20,5	40,5	241	34	765
223	—	97,3	(18,8)	—	234	—	—
217	—	96,4	(17,5)	—	228	33	725
212	—	95,5	(16,0)	—	222	—	705
207	—	94,6	(15,2)	—	218	32	690
201	—	93,8	(13,8)	—	212	31	675
197	—	92,8	(12,7)	—	207	30	655
192	—	91,9	(11,5)	—	202	29	640
187	—	90,7	(10,0)	—	196	—	620
183	—	90,0	(9,0)	—	192	28	615
179	—	89,0	(8,0)	—	188	27	600
174	—	87,8	(6,4)	—	182	—	585
170	—	86,8	(5,4)	—	178	26	570
167	—	86,0	(4,4)	—	175	—	560
163	—	85,0	(3,3)	—	171	25	545
156	—	82,9	(0,9)	—	163	—	525
149	—	80,8	—	—	156	23	505
143	—	78,7	—	—	150	22	490
137	—	76,4	—	—	143	21	460
131	—	74,0	—	—	137	—	450
126	—	72,0	—	—	132	20	435
121	—	69,8	—	—	127	19	415
116	—	67,6	—	—	122	18	400
111	—	65,7	—	—	117	15	385

- 1) Figures within the ( ) are not commonly used
- 2) Rockwell A, C and D scales utilises a diamond brale
- 3) 1 N/mm<sup>2</sup> = 1 MPa

## ■ Finished Surface Roughness

### ● Types of Surface Roughness Measurements

Types	Symbol	Method of Determination	Descriptive Figure
Maximum Height	* 1) Ry	This is the value (expressed in $\mu\text{m}$ ) measured from the deepest valley to the highest peak of the reference line, $\ell$ , extracted from the profile.  (Disregard unusually high peaks and deep valleys as they are considered as flaws.)	
Ten-point Mean Roughness	* 2) Rz	From the profile, extract a portion to be the reference line, $\ell$ .  Select the 5 highest peak and 5 deepest valleys. Measure the distance between the two lines and express it in $\mu\text{m}$ . (1 $\mu\text{m}$ = 0,001mm)	
Calculated Roughness	Ra	This method is to obtain a center line between the peaks and valleys within the reference line, $\ell$ . Fold along the center line to superimpose the valleys against the peaks. (Shaded portions with dashed outline on the right figure). Take the total shaded area and divided it by $\ell$ in $\mu\text{m}$ .	

Designated values of the above types of surface roughness, standard reference length values and the triangular symbol classifications are shown on the table on the right.

- \* 1) Ry : According to new JIS B 0601:2001 (Old symbol: Rz)  
 \* 2) Rz : According to new JIS B 0601:2001 (Old symbol: Rz<sub>JIS</sub>)

Designated values for * 1) Ry	Designated values for * 2) Rz	Designated values for Ra	Standard reference length values, $\ell$ (mm)	Triangular Symbols
(0,05S) 0,1S 0,2S 0,4S	(0,05Z) 0,1Z 0,2Z 0,4Z	(0,013a) 0,025a 0,05a 0,10a	—	
0,8S	0,8Z	0,20a	0,25	
1,6S 3,2S 6,3S	1,6Z 3,2Z 6,3Z	0,4a 0,8a 1,6a	0,8	
12,5S (18S) 25S	12,5Z (18Z) 25Z	3,2a 6,3a	2,5	
(35S) 50S (70S) 100S	(35Z) 50Z (70Z) 100Z	12,5a 25a	—	
(140S) 200S (280S) 400S (560S)	(140Z) 200Z (280Z) 400Z (560Z)	(50a) (100a)	—	—

Remarks: The designated values in the brackets do not apply unless otherwise stated.





# Spare Parts

P1–P8

# P



Screw .....	P2-P4
Lever Pin, Shim, Nut.....	P4-P6
Shim Pin, Eccentric Pin .....	P7
Wrench .....	P8

# SPARE PARTS

## Screw

### ■ Screw

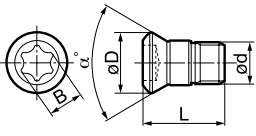
High Precision Screw	Cat. No.	Stock	Dimensions (mm)						$\alpha^\circ$	$\text{Nm}$
			d	Pitch	L	D	B			
	BFTG0408F	●	M4	0,5	7,5	5,7	T15	61	3,4	
	BTTG0409F	●	M4	0,5	8,4	6,15	T15	61	3,4	
	BFTG0513F	●	M5	0,5	13	6,8	T20	61	5,0	
	BFTG0617F	●	M6	0,75	16,5	8	T25	61	7,5	
	BFTG0621F	○	M6	0,75	21	9,5	T25	61	7,5	
	BFTG0825F	●	M8	0,75	24,5	12	T25	61	7,5	

Torx Flat Head Screw	Cat. No.	Stock	Dimensions (mm)						$\alpha^\circ$	$\text{Nm}$
			d	Pitch	L	D	B			
	BFTX016033	○	M1,6	0,35	3,3	2,6	T6	60	0,2	
	BFTX02508	●	M2,5	0,45	7,5	3,45	T8	60	-	
	BFTX0309	●	M3	0,5	8,8	4,2	T10	60	-	
	BFTX03508	●	M3,5	0,6	8	5,1	T10	52	2,0	
	BFTX03584	●	M3,5	0,6	7,4	5,2	T15	60	3,0	
	BFTX03588	●	M3,5	0,6	8,8	5,2	T15	60	3,4	
	BFTX0408	●	M4	0,7	8	5,5	T15	60	-	
	BFTX0414	●	M4	0,7	14,5	5,5	T15	60	3,0	
	BFTX0515	●	M5	0,8	15	7	T20	60	-	
	BFTX0613	●	M6	1,0	13	9	T25	60	-	
	BFTX0615	●	M6	1,0	15	9	T25	60	-	
	BFTX0617	●	M6	1,0	17	9	T25	60	-	

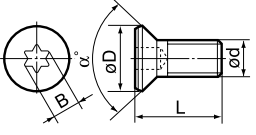
Torx Flat Head Screw	Cat. No.	Stock	Dimensions (mm)						$\alpha^\circ$	$\text{Nm}$
			d	Pitch	L	D	B			
	BFTX0203A	●	M2	0,4	3	2,7	T6	90	0,5	
	BFTX0204A	●	M2	0,4	4,3	2,7	T6	90	0,5	
	BFTX0305A	●	M3	0,5	5,3	4,3	T10	90	-	
	BFTX0306A	●	M3	0,5	5,8	4,3	T10	90	2,0	
	BFTX0307A	●	M3	0,5	6,8	4,3	T10	90	2,0	
	BFTX0407A	●	M4	0,7	7,3	5,6	T15	90	3,4	
	BFTX0410A	●	M4	0,7	10,3	5,6	T15	90	3,4	
	BFTX0509A	●	M5	0,8	9,3	6,9	T20	90	5,0	

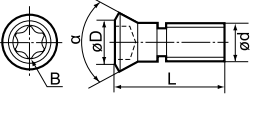
Torx Flat Head Screw	Cat. No.	Stock	Dimensions (mm)						$\alpha^\circ$	$\text{Nm}$
			d	Pitch	L	D	B			
	BFTX01604N	●	M1,6	0,35	4,2	2,4	T6	60	0,2	
	BFTX0203N	●	M2	0,4	3	2,7	T6	60	0,5	
	BFTX0204N	●	M2	0,4	4,3	2,7	T6	60	0,5	
	BFTX02205N	●	M2,5	0,45	4,5	3	T6	60	0,5	
	BFTX2206NT	○	M2,2	0,45	6	3,2	T1,8	60	0,7	
	BFTX02505N	●	M2,5	0,45	4,5	3,45	T8	60	1,1	
	BFTX02506N	●	M2,5	0,45	5,5	3,45	T8	60	1,5	
	BFTX02508NV	●	M2,5	0,45	7,5	3,5	T8	60	1,5	
	BFTX0306N	○	M3	0,5	5,8	4,2	T10	60	2,0	
	BFTX0307N	●	M3	0,5	6,5	4,2	T10	60	2,0	
	BFTX03085N	○	M3	0,5	8,5	5,4	T10	60	-	
	BFTX0309N	●	M3	0,5	9	4,2	T10	60	3,0	
	BFTX0312N	○	M3	0,5	12	5,4	T10	60	-	
	BFTX03509N	●	M3,5	0,6	8,5	4,9	T10	60	-	
	BFTX0406N	●	M4	0,7	6	5,6	T15	60	-	
	BFTX0407N	●	M4	0,7	7	5,6	T15	60	3,0	
	BFTX0409N	●	M4	0,7	9	5,6	T15	60	3,4	
	BFTX0412N	●	M4	0,7	12	5,5	T15	60	3,0	
	BFTX0509N	●	M5	0,8	9	7	T20	60	5,0	
	BFTX0511N	●	M5	0,8	11,5	7	T20	60	5,0	
	BFTX0513N	●	M5	0,8	13	7	T20	60	5,0	
	BFTX0515N	●	M5	0,8	15	7	T20	60	-	
	BFTX0615N	●	M6	1,0	15	9	T25	60	5,0	
	BFTX0619N	●	M6	1,0	19	9	T25	60	5,0	

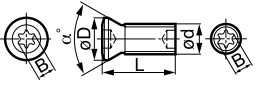
Torx Flat Head Screw	Cat. No.	Stock	Dimensions (mm)						$\alpha^\circ$	$\text{Nm}$
			d	Pitch	L	D	B			
	BFTX0410T8L	●	M4	0,7	9,6	5,6	T8	60	1,1	
	BFTX0410T8R	●	M4	0,7	9,6	5,6	T8	60	1,1	

### ■ Screw

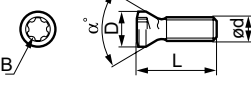
Torx Plus Flat Head Screw	Cat. No.	Stock	Dimensions (mm)						$\alpha^\circ$	$\text{Nm}$
			d	Pitch	L	D	B			
	BFTX01804IP	○	M1,8	0,35	3,7	2,45	6IP	60	0,5	
	BFTX02505IP	●	M2,5	0,45	4,5	3,45	8IP	60	-	
	BFTX02506IP	●	M2,5	0,45	5,5	3,45	8IP	60	-	
	BFTX0305IP	●	M3	0,5	5,3	3,8	8IP	60	2,0	
	BFTX0306IP	●	M3	0,5	6	3,8	8IP	60	2,0	
	BFTX0307IP	●	M3	0,5	7	4,3	10IP	55	2,0	
	BFTX0308IP	●	M3	0,5	8	3,8	8IP	60	-	
	BFTX03510IP	●	M3,5							
	BFTX03512IP	●	M3,5	0,6	11,5	5,3	15IP	60	3,0	
	BFTX03584IP	●	M3,5	0,6	7,4	5,1	15IP	60	-	
	BFTX03510IP08	●	M3,5	0,6	10	5,3	8IP	60	-	
	BFTX03510IP15	●	M3,5	0,6	10	5,3	15IP	60	-	
	BFTX0407IP	●	M4	0,7	8,0	5,6	15IP	60	3,0	
	BFTX0409IP	●	M4	0,7	9,0	5,6	15IP	60	3,0	
	BFTX0412IP	●	M4	0,7	12	5,5	15IP	60	3,0	
	BFTX0418IP	●	M4	0,7	18	5,5	15IP	60	-	
	BFTX04513IP20	●	M4,5	0,75	13,1	6,8	20IP	60	-	
	BFTX0511IP	●	M5	0,8	11,5	7	20IP	60	-	
	BFTX0513IP	●	M5	0,8	13	7	20IP	60	-	
	BFTX0615IP	●	M6	1,0	15	9	25IP	60	-	

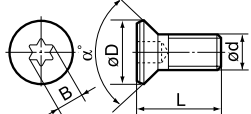
Torx Flat Head Screw	Cat. No.	Stock	Dimensions (mm)						$\alpha^\circ$	$\text{Nm}$
			d	Pitch	L	D	B			
	BFTX03510SD	●	M3,5	0,6	10	5,3	T10	60	2,0	
	BFTX03517SD	●	M3,5	0,6	17	5,3	T10	60	2,0	
	BFTX0517SD	●	M5	0,8	17	7,2	T20	60	5,0	
	BFTX0618SD	●	M6	1,0	18		T25	60	7,5	

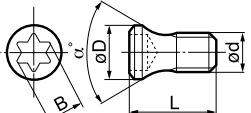
Torx Flat Head Screw	Cat. No.	Stock	Dimensions (mm)						$\alpha^\circ$	$\text{Nm}$
			d	Pitch	L	D	B			
	BFTY02205	●	M2,2	0,45	5,0	3,05	T7	60	-	
	BFTY02206	●	M2,2	0,45	5,6	3,05	T7	60	1,0	

Button Head Cap Screw	Cat. No.	Stock	Dimensions (mm)						$\text{Nm}$
			d	Pitch	L	$\ell$	D	B	
	BH0304	●	M3	0,5	4	Full	5,5	2	-
	BH0306	●	M3	0,5	6	Full	5,5	2	-
	BH0308 (FBUP3-A0-9)	●	M3	0,5	8	Full	5,5	2	1,0
	BH0310	●	M3	0,5	10	Full	5,5	2	-
	BH0315	○	M3	0,5	10	Full	5,5	2	-
	BH03504	●	M3,5	0,6	4	Full	7	2	-
	BH0408	○	M4	0,7	8	Full	6	2,5	-
	BH0415	●	M4	0,7	15	Full	7,5	2,5	-
	BH0510	●	M5	0,8	10	Full	9,5	3	-
	BH0516	●	M5	0,8	16	14,4	9,5	3	-
	BH0616	●	M6	1,0	16	14	10,5	4	-
	BH0620	●	M6	1,0	20	Full	10,5	4	-
	BH0824R	●	M8	1,25	24	20	12	4	-
	BH0824L	●	M8	1,25	24	20	12	4	-
	BH0825	●	M8	1,25	25	22,5	14	5	-
	BH0830R	○	M8	1,25	30	26	12	4	-
	BH0830L	●	M8	1,25	30	26	12	4	-
	BH0832	●	M8	1,25	32	29,5	14	5	-
	BH1030R	○	M10	1,5	30	26	14	5	-
	BH1030L	●	M10	1,5	30	26	14	5	-
	BH1036R	○	M10	1,5	36	32	14	5	-
	BH1036L	○	M10	1,5	36	32	14	5	-

### Hexagonal Hole Type

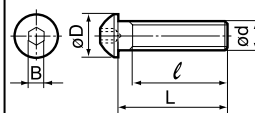

### T Type with Torx Hole

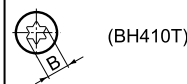

# SPARE PARTS

## Screw

### ■ Screw

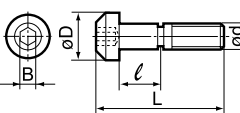
Phillip Head Cap Screw	Cat. No.	Stock	Dimensions (mm)						
			d	Pitch	L	ℓ	D	B	
	BHA0525	●	M5	0,8	25,5	9,5	8,5	3	4,0
	BHA0625	●	M6	1,0	30	11,3	10,5	4	4,5
	BHA0834		M8	1,25	34,2	12,7	12,0	5	-
	BHE0407		M4	0,7	9,5	2	5,7	2,5	1,8
	BHE0510		M5	0,8	13	3	7,7	3	2,7

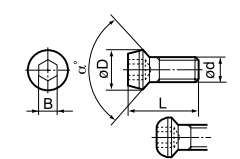
Button Head Screw	Cat. No.	Stock	Dimensions (mm)						
			d	Pitch	L	D	B	α°	
	BHF0203L		M2	0,4	4	3	1,5	90	
	BHF0203B		M2	0,4	5,5	3,5	1,5	90	
	BHF0306R	●	M3	0,5	6,3	4,2	2	90	1,0
	BHF0308R	●	M3	0,5	8	4,2	2	90	1,0
	BHF0410	●	M4	0,7	11,5	6	3	90	-
	BHF0623	○	M6	1,0	23	12	4	90	7,0

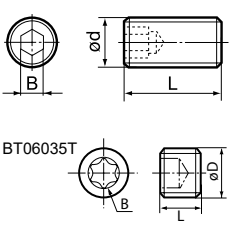
Set Screw	Cat. No.	Stock	Dimensions (mm)						
			d	Pitch	L	D	B	α°	
	BT0306		M3	0,5	6	-	1,5	-	-
	BT0310		M3	0,5	10	-	1,5	-	-
	BT0404	●	M4	0,7	4	-	2	-	-
	BT0408	○	M4	0,7	8	-	2	-	-
	BT0412	○	M4	0,7	12	-	2	-	-
	BT0506	●	M5	0,8	6	-	2,5	-	-
	BT0510		M5	0,8	10	-	2,5	-	-
	BT0610	○	M6	1,0	10	-	3	-	-
	BT0612		M6	1,0	12	-	3	-	-
	BT0620		M6	1,0	20	-	3	-	-
BT06035T		M6	1,0	3,5	-	T15	-	-	

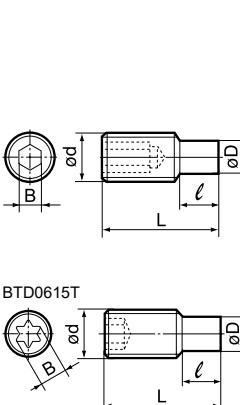
Set Screw	Cat. No.	Stock	Dimensions (mm)						
			d	Pitch	L	ℓ	D	B	
	BTD0408		M4	0,7	8	2	2,8	2	-
	BTD0410		M4	0,7	10	2	2,8	2	-
	BTD0412		M4	0,7	12	2	2,8	2	-
	BTD0508		M5	0,8	8	3	3,5	2,5	-
	BTD05F09		M5	0,5	9	2	4	T15	-
	BTD0510	○	M5	0,8	10	3	3,5	2,5	3,0
	BTD0518		M5	0,8	18	4	3,5	2,5	-
	BTD0609	○	M6	1,0	9	2	4	3	-
	BTD0615		M6	1,0	15	5	4	3	-
	BTD0618		M6	1,0	18	5	4	3	-
	BTD0620		M6	1,0	20	5	4	3	-
	BTD0812	○	M8	1,25	12	2	5	4	-
	BTD0818		M8	1,25	18	6	5	4	-
	BTD0820		M8	1,25	20	6	5	4	-
	BTD0825		M8	1,25	25	8,5	5	4	-
BTD0615T		M6	1,0	15	5	4,3	T20	-	

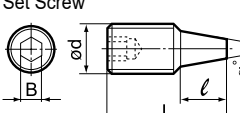
Set Screw	Cat. No.	Stock	Dimensions (mm)						
			d	Pitch	L	ℓ	B	α°	
	BTT0407	●	M4	0,5	7	2,6	2	60	-
	BTT0411	●	M4	0,5	11	2,6	2	60	-
	BTT0511		M5	0,8	11	5	2	20	-
	BTT0615		M6	1,0	15	6	2,5	20	-

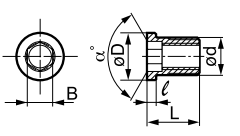
Special Hollow Screw	Cat. No.	Stock	Dimensions (mm)						
			d	Pitch	L	ℓ	D	B	
	BW0507F	●	M5	0,5	7	1,2	6,3	3,5	-
	BW0609F	●	M6	0,75	9	1,5	7,7	4	-
	BW0508F-SD		M5	0,5	8	1,2	6,3	3,5	-
	BW0810F-SD		M8	0,75	10	1,8	10	5	-
	BW0912F-SD		M9	0,75	12				-

### ■ Screw

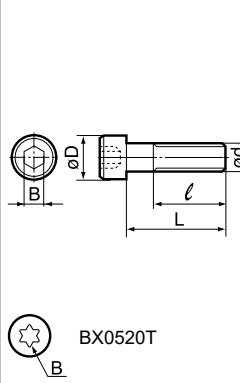
Cap Screw	Cat. No.	Stock	Dimensions (mm)						
			d	Pitch	L	ℓ	D	B	
	BX0304	○	M3	0,5	4	Full	5,5	2,5	-
	BX0308	●	M3	0,5	8	Full	5,5	2,5	-
	BX0315	○	M3	0,5	15	Full	5,5	2,5	-
	BX0410		M4	0,7	10	Full	7	3	-
	BX0414	●	M4	0,7	14	Full	7	3	-
	BX0425	○	M4	0,7	25	20	7	3	-
	BX0508		M5	0,8	8	Full	8,5	4	-
	BX0510		M5	0,8	10	Full	8,5	4	-
	BX0512	●	M5	0,8	12	Full	8,5	4	-
	BX0515	●	M5	0,8	15	Full	8,5	4	-
	BX0520	●	M5	0,8	20	Full	8,5	4	5,0
	BX0520T	●	M5	0,8	20	16	8,5	T20	-
	BX0615	○	M6	1,0	15	Full	10	5	-
	BX0620	○	M6	1,0	20	Full	10	5	-
	BX0622	●	M6	1,0	22	18	10	5	-
	BX1045	○	M10						
	BX1060	○	M10	1,5	60		16	8	
BX1070	○	M10							
BX1240	○	M12							

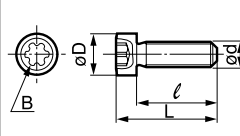
Cap Screw (Torx Plus)	Cat. No.	Stock	Dimensions (mm)						
			d	Pitch	L	ℓ	D	B	
	BXD02208IP	●	M2,2	0,45	7,5	5,7	3,5	8IP	-
	BXD02509IP	●	M2,5	0,45	9	7	4,1	10IP	-
	BXD03011IP	●	M3	0,5	10,5	8	4,9	15IP	-
	BXD03512IP	●	M3,5	0,6	11,5	8,8	5,5	15IP	-
	BXD04014IP	●	M4	0,7	12,5	9,5	6	20IP	-
	BXD04515IP	●	M4,5	0,75	14,3	10,8	6,8	25IP	-

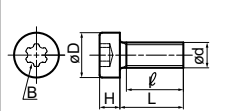
Cap Screw (Torx Plus)	Cat. No.	Stock	Dimensions (mm)						
			d	Pitch	L	ℓ	D	H	
	BXA0310IP	○	M3	0,5	7,5	Full	5,3	2,4	10IP
									2,0

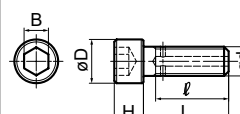
Cap Screw with Oil Hole	Cat. No.	Stock	Dimensions (mm)						
			d	Pitch	L	ℓ	D	H	
	BXH0825-D13		M8	1,25	25	Full	13	8	6
	BXH1030-D16		M10	1,5	30	Full	16	10	8
	BXH1235-D18		M12	1,75	35	Full	18	12	10

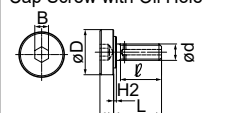
Cap Screw with Oil Hole	Cat. No.	Stock	Dimensions (mm)						
			d	Pitch	L	ℓ	D	H1	
	BXH1235-D33		M12	1,75	35	Full	33	10	2
	BXH1635-D40		M16	2,0	35	30	40	10	-
	BXH2036-D50		M20	2,5	36	29	50	14	4

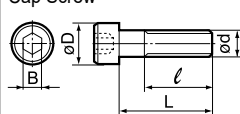
Cap Screw	Cat. No.	Stock	Dimensions (mm)						
			d	Pitch	L	ℓ	D	B	
	EHBX0512	●	M5	0,8	12	10,5	8	4	-

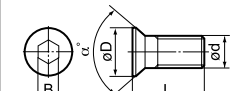
Flat Head Screw	Cat. No.	Stock	Dimensions (mm)						
			d	Pitch	L	ℓ	B	α°	
	FBUP2-A0-8	○	M3	0,5	10	5,5	2	82	1,0
	FBUP3-A0-9	●							
	FBUP4-A0-8		M5	0,8	15	9,3	3	82	2,7

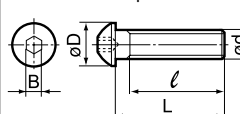
Button Head Cap Screw	Cat. No.	Stock	Dimensions (mm)						
			d	Pitch	L	ℓ	D	B	
	FBUP3-A0-9	●	M3	0,5	8	Full	5,5	2	1,0

# SPARE PARTS

## Screw, Lever Pin

### ■ Screw

Axial adjustment Screw	Cat. No.	Stock	Dimensions (mm)						Nm
			d	Pitch	L	ℓ	D	B	
	FMJ	●	M4	0,5	15	5	6	3	-
	FMUJ	○	M4	0,7	17	10,5	6	1	-
	RFJ	○	M4	0,7	12	6	6	2	-
	SRFJ	○	M4	0,7	17	10,5	6	2	-
	Cat. No.	Stock	Dimensions (mm)						Nm
	KGBS1111	●	M5	0,5	8	1,2	6	3,5	
	KGBS1221	●	M6	0,75	9	1,5	7,5	4,5	
	Cat. No.	Stock	Dimensions (mm)						Nm
	KSS1111	●	3,5	0,6	11	5,2	T15	55	3,5
	KSS1221	●	4,5	0,75	12	6,6	T15,3	55	4,5
	Cat. No.	Stock	Dimensions (mm)						Nm
	LCS2B		M3	0,5	10	3,05	3,6	2	-
	LCS3	●	M6	1,0	17	10	6	2,5	-
	LCS3B-SD	●	M5	0,8	9,5	4,2	5	2	-
	LCS3DB-SD	●	M5	0,8	12	6	5	2	-
	LCS3S	●	M6	1,0	15	10	6	2,5	-
	LCS3TB-SD	●	M6	1,0	16,7	9,6	6	2,5	-
	LCS3TE	●	M6	1,0	15,5	8,5	6	2,5	-
	LCS4	●	M8	1,0	21	10	8	3	-
	LCS4B-SD	●	M6	1,0	13,4	9	6	2,5	-
	LCS41BS-SD	●	M8	1,0	17	9,3	8	3	-
	LCS42BS-SD	●	M8	1,0	20,7	9,8	8	3	-
	LCS4CA	●	M8	1,0	17,5	10	8	3	-
	LCS5	●	M8	1,0	25	12	8	3	-
	LCS5B-SD	●	M8	1,0	20,5	12,3	8	3	-
	LCS5DB-SD	●	M8	1,0	21,1	11,4	8	3	-
	LCS6	○	M10	1,0	27,2	14,4	9,8	4	-
	LCS6B-SD	●	M10	1,0	27,2	14,4	10	4	-
	LCS10	●	M5	0,8	14,5	8,5	5	2	-
	LCS12	●	M6	1,0	17	9,6	6	2,5	-
	LCS16	●	M6	1,0	21	13,6	6	2,5	-
	LCS20	●	M8	1,0	23,5	13,2	8	3	-
	LCS25	●	M10	1,0	30	17,4	10	4	-
	LCS32	●	M12	1,0	36	19,3	12	5	-
	Cat. No.	Stock	Dimensions (mm)						Nm
	MIB1.6-2	●	M1,6	0,35	2,0	-	2,4	-	0,2
	MIB1.6-2.5	●	M1,6	0,35	2,5	-	2,4	-	0,2
	MIB1.6-3	●	M1,6	0,35	3,0	-	2,4	-	0,2

### ■ Double Screw

Double Screw	Cat. No.	Stock	Dimensions (mm)						Nm
			d	Pitch	L	ℓ	D	B	
	WB4-8		M4	0,7	7,5	3	3,0	2	-
	WB5-10	●	M5	0,8	10	4	3,8	2,5	-
	WB5-12	○	M5	0,8	12	5	3,8	2,5	-
	WB5-18	○	M5						
	WB6-13	○	M6	1,0	13	5	4,5	3	-
	WB6-16	●	M6	1,0	16	6	4,5	3	-
	WB6-20	○	M6	1,0	20	8,5	4,5	3	-
	WB6-30	○	M6	1,0	30	12	4,5	3	-
	WB8-20	●	M8	1,25	20	8,5	6,2	4	-
	WB8-24	●	M8	1,25	24	8,5	6,2	4	-
	WB8-30	●	M8	1,25	30	11,5	6,2	4	-
	WB8F-30	○	M8	1,0	30	11,5	6,2	4	-
	Cat. No.	Stock	Dimensions (mm)						Nm
	WB6-16T	●	M6	1,0	16	6	4,5	T20	-
	WB6-20T	○	M6	1,0	20	8,5	4,5	T20	-
	WB6-20TL	○	M6	1,0	20	8,5	4,5	T20	-
	WB7-15T	●	M7	1,0	15	5,5	5	T25	-
	WB7F-15T	○	M7	0,75	15	8,5	5,5	T25	-
	WB7F-20TL	○	M7	0,75	20	8,5	5,5	T25	-
	WB8-22T	●	M8	1,25	22	8,5	6,2	T27	-
	WB8-22TL	○	M8	1,25	22	8,5	6,2	T27	-
	WB8-30T	●	M8	1,25	30	11,5	6,2	T27	-
	WB8-30TL	○	M8	1,25	30	11,5	6,2	T27	-
	WB8R-16T	○	M8	1,25	14	5,5	6,2	T27	-
	Cat. No.	Stock	Dimensions (mm)						
	LCL3		A	H	L	C			
	LCL3-SD	●	3,7	12	10	3,6			
	LCL3C-SD		3,1	7,8	9,9	3,1			
	LCL3D-SD	●	3,7	11,5	12	3,55			
	LCL3DB-SD		3,1	9,4	11,5	3,1			
	LCL3S	●	3,7	10,6	10	3,6			
	LCL3T-SD		2,6	6,3	7,2	2,15			
	LCL4		4,7	14	14,55	4,7			
	LCL4-SD	●	4,65	13,2	13,35	4,7			
	LCL4C-SD		4,65	10	13,35	4,7			
	LCL4D-SD	●	4,65	14,8	16	4,7			
	LCL4T-SD		4,65	13,2	13,35	4,7			
	LCL5		6	17	17,1	6			
	LCL5-SD		6	17,3	16,65	6			
	LCL5C-SD		7,5	18,1	20,5	7,5			
	LCL6-SD		7,5	21	20,5	7,5			
	LCL8		8,6	25,4	25,4	8,6			
	Cat. No.	Stock	Dimensions (mm)						
	LCL06	●	2,5	6,28	7,0	2			
	LCL09	●	3,5	9,3	10,75	3			
	LCL10	●	3,4	11,8	10,8	3			
	LCL12	●	3,7	13,4	12,9	3,5			
	LCL16	●	4,6	17,6	18,4	4,4			
	LCL20	○	6	18,9	20,4	5,6			
	LCL32		8,5	26,8	29,8	8			

### ■ Lever Pin

# SPARE PARTS Shim

## ■ Shim

Cat. No.	Stock	Dimensions (mm)			
		A	T	d <sub>1</sub>	d <sub>2</sub>
<b>CCS09T3</b>	●	8,525	2,38	5,4	6,4

Cat. No.	Stock	Dimensions (mm)			
		A	T	d <sub>1</sub>	d <sub>2</sub>
<b>CNS1204</b>	●	12,57	4,76	4,4	6,0
<b>CNS1606</b>	●	15,75	4,76	5,5	7,5
<b>CNS1906</b>	●	18,70	6,35	5,5	7,5
<b>CNS2509</b>	○	25,27	6,35	6,6	9,5
<b>CNS1203B</b>	●	12,57	3,18	3,4	4,5
<b>CNS1204B</b>	●	12,57	4,76	4,4	6,0

Cat. No.	Stock	Dimensions (mm)			
		A	T	d <sub>1</sub>	d <sub>2</sub>
<b>DCS11T3</b>	●	8,5	2,38	5,3	6,4

Cat. No.	Stock	Dimensions (mm)				θ°
		A	T	d <sub>1</sub>	d <sub>2</sub>	
<b>DGCS13R</b>	●	13,7	3,9	6,8	8,8	5

Cat. No.	Stock	Dimensions (mm)			
		A	T	d <sub>1</sub>	d <sub>2</sub>
<b>DNS1504</b>	●	12,57	6,35	4,4	6,0
<b>DNS1506</b>	●	12,57	4,76	4,4	6,0
<b>DNS1104B</b>	○	9,45	4,73	3,4	4,5
<b>DNS1504B</b>	○	12,57	6,35	4,4	6,0
<b>DNS1506B</b>	○	12,57	4,76	4,4	6,0

Cat. No.	Stock	Dimensions (mm)			
		A	T	d <sub>1</sub>	d <sub>2</sub>
<b>HE060011E</b>	●				

Cat. No.	Stock	Dimensions (mm)		
		A	T	d
<b>LST317SD</b>	●	9,5	2,7	5,2
<b>LST42SD</b>		12,65	3,18	6,9

Cat. No.	Stock	Dimensions (mm)		
		A	T	d
<b>LSS32SD</b>		9,48	3,18	5
<b>LSS42SD</b>	●	12,65	3,18	6,9
<b>LSS53SD</b>		15,85	4,76	7,9
<b>LSS63SD</b>		19	4,76	10

Cat. No.	Stock	Dimensions (mm)		
		A	T	d
<b>LSC32SD</b>			3,18	5
<b>LSC42SD</b>	●	12,65	3,18	6,9
<b>LSC53SD</b>		15,85	4,76	7,9
<b>LSC63SD</b>	●	19	4,76	10

Cat. No.	Stock	Dimensions (mm)		
		A	T	d
<b>LSD32SD</b>	●	8,5	3,18	5
<b>LSD42SD</b>		12,65	3,18	6,9

## ■ Shim

Cat. No.	Stock	Dimensions (mm)		
		A	T	d
<b>LSR817</b>	○	8,4	2,7	5,2
<b>LSR10</b>	●	8,4	3,18	4,7
<b>LSR12</b>	●	10	3,18	4,7
<b>LSR16</b>	●	13,5	4,76	6,3
<b>LSR20</b>	●	17,2	4,76	7,9
<b>LSR25</b>		22	6,35	9,5

Cat. No.	Stock	Dimensions (mm)			
		A	T <sub>1</sub>	T <sub>2</sub>	d <sub>2</sub>
<b>LSTE31-0</b>	●	9,5	2,7	2,7	5,2
<b>LSTE31-1</b>	●	9,5	2,67	2,91	5,2
<b>LSTE31-2</b>	●	9,5	2,64	3,11	5,2

Cat. No.	Stock	Dimensions (mm)				θ°
		A	T	d	d	
<b>SCND433</b>	○	12,65	4,76	3,4		80
<b>SCN0903</b>		9,5	3,18	3,4		

Cat. No.	Stock	Dimensions (mm)			
		A	T	d <sub>1</sub>	d <sub>2</sub>
<b>SCS1204</b>		11,5	3,18	6,4	7,9

Cat. No.	Stock	Dimensions (mm)			
		A	T	d <sub>1</sub>	d <sub>2</sub>
<b>SNS1204</b>	●	12,57	4,76	4,4	6,0
<b>SNS1506</b>	●	15,75	4,76	5,5	7,5
<b>SNS1906</b>	●	18,92	6,35	5,5	7,5
<b>SNS2507</b>	○	25,27	7,93	6,6	9,5
<b>SNS2509</b>	●	25,27	6,35	6,6	9,5

Cat. No.	Stock	Dimensions (mm)				
		A	T	d <sub>1</sub>	d <sub>2</sub>	θ°
<b>SVW322</b>	○	9,5	3,18	4,7	6,5	35
<b>SFW433</b>		12,65	4,76	6,2	8,0	50
<b>SDW323</b>	●	9,5	3,18	4,7	6,5	55
<b>SDW423</b>	●	12,65	3,18	6,2	8,0	55
<b>SDW433</b>		12,65	3,18	6,2	8,0	80
<b>SCW423</b>	●	12,65	3,18	6,2	8,0	80
<b>SCW433</b>						
<b>SCW635</b>	○	19	4,76	9	11,5	80

Cat. No.	Stock	Dimensions (mm)			
		D			
<b>SRND32</b>	●	9,5			
<b>SRND42</b>	○	12,7			

Cat. No.	Stock	Dimensions (mm)		
		A	T	d
<b>SSND423</b>		12,5	3,18	3,4
<b>SSND423Z</b>	○			
<b>SSND433</b>	○	12,5	4,76	3,4



# SPARE PARTS

## Shim, Nut

### Shim

Cat. No.	Stock	Dimensions (mm)				
		A	T	d <sub>1</sub>	d <sub>2</sub>	
<b>SSW423</b>		12,65	3,18	6,2	8	
<b>SSW433</b>	●	12,65	4,76	6,2	8	
<b>SSW635</b>		19	4,76	9	11,5	

Cat. No.	Stock	Dimensions (mm)				
		A	T	d		θ°
<b>STPD322</b>	●	8,4	3,18	3,4		6
<b>STPD422</b>	○	11,0	3,18	3,4		6

Cat. No.	Stock	Dimensions (mm)				
		A	T	d <sub>1</sub>	d <sub>2</sub>	
<b>STW323</b>	●	9,5	3,18	4,7	6,5	
<b>STW434</b>	●	12,65	4,76	6,2	8	
<b>STW333</b>	○					

Cat. No.	Stock	Dimensions (mm)				
		A	T	d <sub>1</sub>	d <sub>2</sub>	
<b>SWW433</b>	●	12,65	5,15	6,2	8	
<b>LSW317</b>	●					

Cat. No.	Stock	Dimensions (mm)				
		A	T	d <sub>1</sub>	d <sub>2</sub>	θ°
<b>TCS16T3</b>		8,8	2,38	5,3	6,3	7

Cat. No.	Stock	Dimensions (mm)				
		A	T	d <sub>1</sub>	d <sub>2</sub>	
<b>TNS1604</b>	●	9,45	4,76	3,4	4,5	
<b>TNS1603B</b>	○	9,45	3,18	3,4	4,5	
<b>TNS1604B</b>	○	9,45	4,76	3,4	4,5	

Cat. No.	Stock	Dimensions (mm)				
		A	T	d <sub>1</sub>	d <sub>2</sub>	
<b>TRW5505</b>	●	10,5	4,76	3,4	4,5	

Cat. No.	Stock	Dimensions (mm)				
		A	T	d <sub>1</sub>	d <sub>2</sub>	
<b>VCS1604</b>	●	8,25	3,18	5,3	6,4	

Cat. No.	Stock	Dimensions (mm)				
		A	T	d <sub>1</sub>	d <sub>2</sub>	
<b>VNS1604</b>	●	9,45	4,76	3,4	4,5	

### Shim

Cat. No.	Stock	Dimensions (mm)				
		A	T	d <sub>1</sub>	d <sub>2</sub>	
<b>WFXS4R</b>	●	10,17	3,0	5,5	7,5	

Cat. No.	Stock	Dimensions (mm)				
		A	T	d <sub>1</sub>	d <sub>2</sub>	θ°
<b>WGCS13R</b>	●	10,7	3,0	5,5	7,5	5

Cat. No.	Stock	Dimensions (mm)				
		A	T	d <sub>1</sub>	d <sub>2</sub>	
<b>WNS0604</b>	●	9,52	3,18	3,5	4,5	
<b>WNS0804</b>	●	12,57	4,76	4,4	6,3	
<b>WNS0603B</b>	●	9,27	3,18	3,4	4,5	
<b>WNS0803B</b>	○	12,57	3,18	3,4	4,5	
<b>WNS0804B</b>	○	12,57	4,76	4,4	6,0	

Cat. No.	Stock	Dimensions (mm)				
		A	T	d		
<b>YE3</b>	●	9,5	3,2	4		
<b>Y13</b>	●	9,5	3,2	4		

### Seat

Cat. No.	Stock	Dimensions (mm)			
		d	L	H	
<b>PWSS4R</b>	▲	4,6	15	8	

### Ring

Cat. No.	Stock	Dimensions (mm)				
		A	B	T	d	
<b>ER03</b>		7	2,6	0,6	3	
<b>ER04</b>	●	9	3,5	0,6	4	
<b>ER05</b>	●	11	4,3	0,6	5	

### Nut

Cat. No.	Stock	Dimensions (mm)				
		L				
<b>BNBW-2</b>	●	3				
<b>BNBW-4</b>	○	4				
<b>BNBW-7</b>	○	7				

Cat. No.	Stock	Dimensions (mm)				
		d	L	D	B	
<b>CPM32N</b>	●	M4	7,5	7	3	
<b>CPM43N</b>	●	M5	8,5	7	3	
<b>CPM43S</b>	○	M5	6	7	3	

Cat. No.	Stock	Dimensions (mm)				
		d	Pitch	L	D	B
<b>CPV33N</b>	●	M4	0,5	6,0	6,0	2,5

# SPARE PARTS

## Shim Pin, Eccentric Pin

### Shim Pin

Cat. No.	Stock	Dimensions (mm)						
		d	Pitch	L	D	d <sub>1</sub>	B	
HE060011P	●	M6	0,75	14,5	7,8	5,0	2,5	

Cat. No.	Stock	Dimensions (mm)		
		d	D	L
LP04	●	0,4	1,1	4,7
LP06	●	0,4	1,1	6,0
LP07	●	0,4	1,1	7,7

Cat. No.	Stock	Dimensions (mm)		
		d	H	L
LSP3		5	3,5	5,5
LSP3SD	●	5	3,5	5,5
LSP4		6,7	4	7
LSP4SD		6,7	4	7
LSP5SD		7,7	4,5	8,5
LSP6SD		9,85	5,9	11,1
LSP8		13,05	10	12
LSP10	●	5	3,3	6,5
LSP16	●	6,6	4,5	9
LSP20	●	8,2	5,5	9
LSP25	○	9,8	6,5	11
LSP32		13	10	12

Cat. No.	Stock	Dimensions (mm)						
		d	Pitch	L	D	D <sub>1</sub>	d <sub>1</sub>	
MP317		M4	0,7	15,5	6	4	3,7	
MP320	●	M4	0,7	19,5	6	4	3,7	
MP416	●	M5	0,8	14	7,5	6	5	
MP420	●	M5	0,8	20	7,5	6	5	
MP432		M5	0,8	32	7,5	6	5	
MP531								
MP534								

Cat. No.	Stock	Dimensions (mm)				
		d	L	D	θ°	
SPP308		3,2	8	4,8	120	

Cat. No.	Stock	Dimensions (mm)		
		L	D	
SPP3	●	14	3,2	

Cat. No.	Stock	Dimensions (mm)					
		d <sub>1</sub>	d <sub>2</sub>	L	D	ℓ <sub>1</sub>	ℓ <sub>2</sub>
VP20	●	M3,5	M4	12,0	5,0	≥4,5	≥4,5
VP25	●	M3,5	M4	17,0	5,0	≥4,5	≥4,5
VP32	●	M3,5	M4	24,0	5,0	≥4,5	≥4,5

Cat. No.	Stock	Dimensions (mm)					
		d	Pitch	L	ℓ	D <sub>1</sub>	D <sub>2</sub>
VP32B	●	M3,5	0,6	8,0	1,4	5,0	6,5
VP40B	●	M3,5	0,6	11,5	1,4	5,0	6,5

### Eccentric Pin

Cat. No.	Stock	Dimensions (mm)					
		d	D <sub>1</sub>	D <sub>2</sub>	L	ℓ	B
CPB34	●	3,4	4,1	5,5	14	5	2,5
CPB35	○	3,4	4,1	5,5	17	5	2,5
CPB42	●	4,5	5,5	7	14	5	3
CPB43	●	4,5	5,5	7	19	5	3
CPB43S	●	4,5	5,5	7	16	5	3
CPB44T	○	4,5	5,5	7	22	5	3
CPB45T	○	4,5	5,5	7	27	5	3
CPB64	○	6,8	8,2	10,5	24	6,6	4

Cat. No.	Stock	Dimensions (mm)					
		d	D <sub>1</sub>	D <sub>2</sub>	L	ℓ	B
CPU304C	○	3,3	5,5	-	10	3,5	3

Cat. No.	Stock	Dimensions (mm)					
		d	D	L	ℓ	B	
TRB10IP	●	10IP	4				
TRB15IP	●	15IP	4				
TRB20IP	●	20IP	4,55				
TRB25IP	●	25IP	5				

Cat. No.	Stock	Dimensions (mm)			
		D	L	Remarks	
HPS1015	●	32	99,4	For 10IP, 15IP	
HPL2025	●	35,5	110,3	For 20IP, 25IP	

### Wrench

Cat. No.	Stock	Dimensions (mm)				
		B	d	C	b <sub>1</sub>	b <sub>2</sub>
TRXW10IP		10IP	2,6	40	75	40

Cat. No.	Stock	Dimensions (mm)				
		B	d			
TRB10IP	●	10IP	4			
TRB15IP	●	15IP	4			
TRB20IP	●	20IP	4,55			
TRB25IP	●	25IP	5			

  

Cat. No.	Stock	Dimensions (mm)		
		D	L	Remarks
HPS1015	●	32	99,4	For 10IP, 15IP
HPL2025	●	35,5	110,3	For 20IP, 25IP

# SPARE PARTS

## Wrench

### Wrench

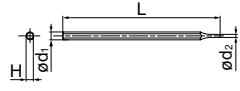
Socket Wrench	Cat. No.	Stock	Dimensions (mm)			
			d <sub>1</sub>	d <sub>2</sub>	L	H
	ANT		5	2	100	4,5

  

Hex Wrench (Hexagonal)	Cat. No.	Stock	Dimensions (mm)			
			B	L	ℓ	
	LH020	●	2	50	16	
	LH025	●	2,5	56	18	
	LH030	●	3	63	20	
	LH035	●	3,5	68	22	
	LH040	●	4	70	25	
	LH050	○	5	80	28	
	LH060	○	6	90	32	

	Cat. No.	Stock	Dimensions (mm)			
			B	C	b <sub>1</sub>	
	LH035K	●				
	LH045K	●				

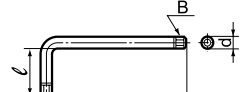

Torx Wrench	Cat. No.	Stock	Dimensions (mm)			
			B	d	L	ℓ
	LT15	○	T15			
	LT20	○	T20	3,9	57,2	19,1
	LT25	○	T25	4,4	60,3	20,2
	LT27	●	T27	4,96	63,5	21,5
	LT1510	○	T15	3,26	62	10

	Cat. No.	Stock	Dimensions (mm)			
			B	C	b <sub>1</sub>	
	LT15K	●				

  

Torx Plus Wrench	Cat. No.	Stock	Dimensions (mm)			
			B	d	L	ℓ
	LT15IP	○				
	LT20IP	○	T20	4,0	57	18,5
	LT25IP	○	T25	4,5	60	19,5

  

	Cat. No.	Stock	Dimensions (mm)			
			B	C	b <sub>1</sub>	
	SDBSM	●				

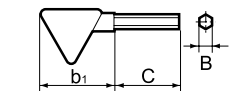

Hex Wrench (Hexagonal)	Cat. No.	Stock	Dimensions (mm)		
			B	b <sub>1</sub>	C
	TH015	●	1,5	35	30
	TH020	●	2	35	39
	TH025	●	2,5	35	39

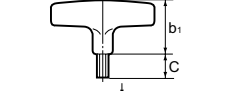

Hex Wrench (Hexagonal)	Cat. No.	Stock	Dimensions (mm)		
			B	b <sub>1</sub>	C
	TH030	●	3	48	28
	TH040	●	4	48	37
	TH050	○	5	48	45

### Wrench

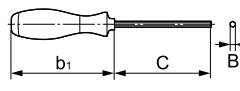
Hex Wrench (Hexagonal)	Cat. No.	Stock	Dimensions (mm)		
			B	C	b <sub>1</sub>
	HD040	○	4	75	111

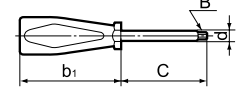

Torx Wrench	Cat. No.	Stock	Dimensions (mm)			
			B	d	C	B <sub>1</sub>
	TRD07	●	T7	2,0	45	70
	TRD08	●	T8	2,3	55	70
	TRD15	○	T15	3,3	70	100
	TRD20	●	T20	3,9	100	90
	TRD25	●	T25	5,3	80	110

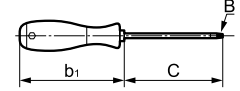

Torx Plus Wrench	Cat. No.	Stock	Dimensions (mm)		
			B	C	b <sub>1</sub>
	TRDR06IP05	●			
	TRDR08IP	●	8IP	60	104
	TRDR10IP	●	10IP	80	111
	TRDR15IP	●	15IP	80	111
	TRDR20IP	●	20IP	100	118
	TRDR25IP	●	25IP	100	118

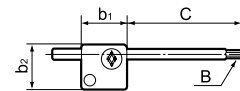

Torx Wrench	Cat. No.	Stock	Dimensions (mm)			
			B	C	b <sub>1</sub>	b <sub>2</sub>
	TRX06	●	T6	35,5	15	15
	TRX08	●	T8	38,5	19	19
	TRX10	●	T10	42,1	22	22
	TRX15	●	T15	46	22	27
	TRX20	●	T20	49	22	30

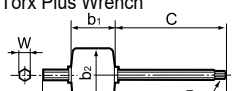

Torx Plus Wrench	Cat. No.	Stock	Dimensions (mm)			
			B	C	b <sub>1</sub>	b <sub>2</sub>
	TRX06IP	●	6IP	34	15	15

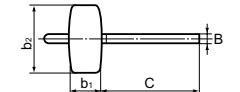

Hex Wrench (Hexagonal)	Cat. No.	Stock	Dimensions (mm)			
			B	C	b <sub>1</sub>	b <sub>2</sub>
	TSW040	●	4	60	20	40

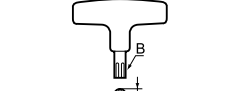

Torx Wrench	Cat. No.	Stock	Dimensions (mm)		
			B	d	
	TT25	●	T25	4,4	
	TT27	●	T27	5,0	

Torx Plus Wrench	Cat. No.	Stock	Dimensions (mm)			
			B	d	C	b <sub>1</sub>
	TTR15IP	●	15IP	4,0	80	25,5

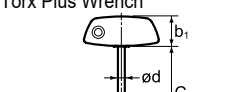
Torx Wrench	Cat. No.	Stock	Dimensions (mm)		
			B	d	
	TTX15W	●	T15	4,0	
	TTX20	●	T20	3,9	

# Index

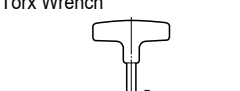
# P

P9–P22

# Index

## A - B

A		
16ER*****CB	F64	Threading inserts
16IR*****CB	F65	Threading inserts
1.8x45	G83, G85, M56, M71, M73	Spare parts
AECT*****PEFRA	G72, G73, H61, H63	Indexable insert
AFBSM**	M50, M51	Spare parts
ANB****R	G79, G81, H85, H87, M63, M65, M67, M69	SUMIDIA blades
ANB****R-G	G79, G81, H85, H87, M63, M65, M67, M69	SUMIDIA blades
ANB****R-GB	G79, G81, H85, H87, M63, M65, M67, M69	SUMIDIA blades
ANB****R-H	G79, G81, H85, H87, M63, M65, M67, M69	SUMIDIA blades
ANB****R-L	G79, G81, H85, H87, M63, M65, M67, M69	SUMIDIA blades
ANB****R-W	G79, G81, H85, H87, M63, M65, M67, M69	SUMIDIA blades
ANB****R-WS	G79, G81, H85, H87, M63, M65, M67, M69	SUMIDIA blades
ANB****R-GX	G79, G81, H85, H87, M63, M65, M67, M69	SUMIDIA blades
ANT	P3	Spare parts
ANXA****R**	G74, G78, H82, M58, M62	Cutter
ANXA****RS**	G74, G78, H82, M58, M62	Cutter
ANXS****E**	G74, H82, H84, M58, M66	Cutter
ANXS****M**	G74, H82, H86, M58, M68	Modular cutter
ANXS****R**	G74, G80, H82, M58, M64	Cutter
ANXS****RS**	G74, G80, H82, M58, M64	Cutter
AOET****PEER-F	G41, G51, G57, H27, H37, H39, H41, H45, H49, H53	Indexable insert
AOET****PEER-P**	G41, H27, H37, H39, H41, H49,	Indexable insert
AOET****PEFR-S	G41, G51, G57, H27, H37, H39, H41, H45, H49, H53	Indexable insert
AOET**T3**PEER-F	G41, G49, G55, H27, H31, H33, H35, H43, H47, H51	Indexable insert
AOET**T3**PEER-P**	G41, H27, H31, H33, H35, H43, H47,	Indexable insert
AOET**T3**PEFR-S	G41, G49, G55, H27, H31, H33, H35, H43, H47, H51	Indexable insert
AOMT****PEER-G	G41, G51, G57, H27, H37, H39, H41, H45, H49, H53	Indexable insert
AOMT****PEER-H	G41, G51, G57, H27, H37, H39, H41, H45, H49, H53	Indexable insert
AOMT****PEER-L	G41, G51, G57, H27, H37, H39, H41, H45, H49, H53	Indexable insert
AOMT**T3**PEER-G	G41, G49, G55, H27, H31, H33, H35, H43, H47, H51	Indexable insert
AOMT**T3**PEER-H	G41, G49, G55, H27, H31, H33, H35, H43, H47, H51	Indexable insert
ASM****	J36	Solid endmill
ASM****DL	J30	Solid endmill
ASM****DL-R**	J30	Solid endmill
AXET****PEFR-S	G58, G59, H57, H58, H65, H66	Indexable insert
AXMT****PDER-G	G58, H56	Indexable insert
AXMT****PDER-H	G58, H56	Indexable insert
AXMT****PDER-L	G58, H56	Indexable insert
AXMT****PDFR-S	G58, H56	Indexable insert
AXMT****PEER-E	G58, G59, H57, H58, H65, H66	Indexable insert
AXMT****PEER-EH	G58, G59, H57, H58, H65, H66	Indexable insert
AXMT****PEER-G	G58, G59, H57, H58, H65, H66	Indexable insert
AXMT****PEER-H	G58, G59, H57, H58, H65, H66	Indexable insert
AXMT****PEER-L	G58, G59, H58, H66	Indexable insert

B		
B***-SCLC R/L ****-**	E14	Boring bar
B***-SDQC R/L ****-**	E17	Boring bar
B***-SDUC R/L ****-**	E16	Boring bar
B***-STUP R/L ****-**	E20	Boring bar
BBT**M*_*	H5	Integreted Arbor
BBT**M**_*	H5	Integreted Arbor
BCS**	F56, F58	Spare parts
BFTG****F	P2	Spare parts
BFTX****	P2	Spare parts
BFTX****	P2	Spare parts
BFTX****A	P2	Spare parts
BFTX****IP	P2	Spare parts
BFTX****IPS	F43	Spare parts
BFTX****IP**	P2	Spare parts
BFTX****IPS	F43	Spare parts
BFTX****N	P2	Spare parts
BFTX****N	P2	Spare parts
BFTX****NV	P2	Spare parts
BFTX****SD	P2	Spare parts
BFTX****SD	P2	Spare parts
BFTX****T8 R/L	F20, P2	Spare parts
BFTY****	P2	Spare parts
BH****	P2	Spare parts
BH****	P2	Spare parts
BH**** R/L	P2	Spare parts
BHA****	P3	Spare parts
BHF****	P3	Spare parts
BNB*** R/L	M53	Boring bar
BNBB**R	M52	Boring bar
BNBC	M53	Spare parts
BNBP 2R*** ** *	J41, M75	SUMIBORON endmill
BNBW-*	P6	Spare parts
BNES****	J40, M74	SUMIBORON endmill
BNGC R/L	M56	Spare parts
BNGG R/L ****-TT	M56	Tool holder
BNGS R/L TT	M56	Spare parts
BNTT**** R/L	M56	SUMIBORON insert
BNZ****R	M53	Boring bar
BSME R/L ****D*S6	M50	Boring bar
BT****	P3	Spare parts
BT****E	F26, F30	Spare parts
BT****T	P3	Spare parts
BTD****	P3	Spare parts
BTR****	D30	Indexable insert
BTT****	P3	Spare parts
BW****F	P3	Spare parts
BW****F-SD	P3	Spare parts
BWS**	F56, F58	Spare parts
BX****	P3	Spare parts
BX****T	P3	Spare parts
BXA****IP	P3	Spare parts
BXH****D**	P3	Spare parts
BXBR****R	E24	Boring bar
BXBR****R-NB	E24	Boring bar
BXD****IP	P3	Spare parts

C

C***-SCLP R/L **	E15	Boring bar
C***-SSKP R/L **	E18	Boring bar
C***-STUB R/L **	E20	Boring bar
C***-STUP R/L **	E20	Boring bar
C***-SWUB R/L **	E23	Boring bar
CBC*	D25	Spare parts
CBC****	D25	Spare parts
CBD4 R/L	D25	Spare parts
CBS**	D25	Spare parts
CCET*****LFY/RFY	C63	Indexable insert
CCET**T***LFY/RFY	C63	Indexable insert
CCET**X***LFY/RFY	C63	Indexable insert
CCET**X***LFY/RFY	C63	Indexable insert
CCEW**X***LF-NU	M5	SUMIBORON insert
CCEW**X***LT-NU	M5	SUMIBORON insert
CCGT*****LAY/RAY	C65	Indexable insert
CCGT**X***LFY/RFY	C65	Indexable insert
CCGT*****LFX/RFX	C64	Indexable insert
CCGT*****LFX/RFX	C64	Indexable insert
CCGT**T***LFX/RFX	C64	Indexable insert
CCGT**T***LFX/RFX	C64	Indexable insert
CCGT**X***LFYS/RFYS	C64	Indexable insert
CCGT**X***LFYS/RFYS	C64	Indexable insert
CCGT*****M NFC	C64	Indexable insert
CCGT*****M NSC	C65	Indexable insert
CCGT*****M NSI	C65	Indexable insert
CCGT*****NAG	C65	Indexable insert
CCGT*****NFV NC2	M4	SUMIBORON insert
CCGT*****NFV NU2	M6	SUMIBORON insert
CCGT*****NLV NC2	M4	SUMIBORON insert
CCGT*****NLV NU2	M6	SUMIBORON insert
CCGT*****NSC	C65	Indexable insert
CCGW**T***	M5	SUMIBORON insert
CCGW*****HS-NC2	M4	SUMIBORON insert
CCGW*****HS-NU	M5	SUMIBORON insert
CCGW*****HS-NU2	M6	SUMIBORON insert
CCGW*****LE-NC2	M4	SUMIBORON insert
CCGW*****LS-NC2	M4	SUMIBORON insert
CCGW*****LT-NU	M5	SUMIBORON insert
CCGW*****LT-NC2	M4	SUMIBORON insert
CCGW*****NC-2	M4	SUMIBORON insert
CCGW*****NC-W2	M4	SUMIBORON insert
CCGW*****NC-WG2	M4	SUMIBORON insert
CCGW*****NC-WH2	M4	SUMIBORON insert
CCGW*****NS	M5	SUMIBORON insert
CCGW*****NU	M5	SUMIBORON insert
CCGW*****NU-2	M6	SUMIBORON insert
CCGW*****NU-WG2	M6	SUMIBORON insert
CCGW*****NU-WH2	M6	SUMIBORON insert
CCH**	G67, H11, H12	Spare parts
CCLN R/L ****-***	D25	Tool holder
CCM 6B L/R	F50	Spare parts
CCM 8 LONG	D25, D26	Spare parts
CCM 8 UL	D25, F50	Spare parts
CCM 8 UR	F50	Spare parts
CCMT*****	M8	SUMIDIA insert
CCMT*****L/R-DM NU	M8	SUMIDIA insert
CCMT*****NF	M8	SUMIDIA insert
CCMT*****NFB	C66	Indexable insert
CCMT*****NFP	C66	Indexable insert
CCMT*****NGD NF	M8	SUMIDIA insert

CCMT*****NGU	C67	Indexable insert
CCMT*****NLD NF	M8	SUMIDIA insert
CCMT*****NLB	C66	Indexable insert
CCMT*****NLU	C66	Indexable insert
CCMT*****NLU-W	C66	Indexable insert
CCMT*****NMU	C67	Indexable insert
CCMT*****NSC	C67	Indexable insert
CCMT*****NSK	C67	Indexable insert
CCMT*****NSU	C66	Indexable insert
CCMT**T***NUS	C67	Indexable insert
CCMW*****	C67	Indexable insert
CCMW*****NF	M8	SUMIDIA insert
CCMW*****RH	M8, M45	SUMIDIA insert
CCMW**T***	C67	Indexable insert
CCS**T*	P5	Spare parts
CGA R/L ****-***	M55	SUMIBORON insert
CNGA*****	C26	Indexable insert
CNGA*****ES-NC4	M9	SUMIBORON insert
CNGA*****HS-NC2	M10	SUMIBORON insert
CNGA*****HS-NC4	M10	SUMIBORON insert
CNGA*****HS-NU2	M12	SUMIBORON insert
CNGA*****HT-NU2	M11	SUMIBORON insert
CNGA*****LE-NU2	M11	SUMIBORON insert
CNGA*****LE-NC2	M9	SUMIBORON insert
CNGA*****LF-NU2	M11	SUMIBORON insert
CNGA*****LS-NU2	M11	SUMIBORON insert
CNGA*****LS-NC2	M9	SUMIBORON insert
CNGA*****LS-NC4	M9	SUMIBORON insert
CNGA*****LT-NU2	M11	SUMIBORON insert
CNGA*****LT-NC2	M9	SUMIBORON insert
CNGA*****NC-2	M9	SUMIBORON insert
CNGA*****NC-4	M9	SUMIBORON insert
CNGA*****NC-W4	M9	SUMIBORON insert
CNGA*****NC-WG4	M9	SUMIBORON insert
CNGA*****NC-WH4	M9	SUMIBORON insert
CNGA*****NU	M12	SUMIBORON insert
CNGA*****NU-2	M11	SUMIBORON insert
CNGA*****NS-2	M11	SUMIBORON insert
CNGA*****NU-W2	M11	SUMIBORON insert
CNGA*****NU-WG2	M11	SUMIBORON insert
CNGA*****NU-WH2	M11	SUMIBORON insert
CNGA*****US-NU2	M12	SUMIBORON insert
CNGG*****LAX/RAX	C28	Indexable insert
CNGG*****NEF	C28	Indexable insert
CNGG*****NFV NC4	M10	SUMIBORON insert
CNGG*****NLV NC4	M10	SUMIBORON insert
CNGG*****NSV NC4	M10	SUMIBORON insert
CNGG*****NGH	C28	Indexable insert
CNGG*****NSU	C28	Indexable insert
CNGM*****NLV NU2	M12	SUMIBORON insert
CNGN*****	M13	SUMIBORON insert
CNGX*****	M13	SUMIBORON insert
CNMA*****	C28	Indexable insert
CNMA*****	M13	SUMIBORON insert
CNMA*****NS	M13	SUMIBORON insert
CNMA*****NU	M13	SUMIBORON insert
CNMA*****NU-W	M13	SUMIBORON insert
CNMG*****NEF	C20	Indexable insert
CNMG*****NEG	C22	Indexable insert
CNMG*****NEM	C23	Indexable insert
CNMG*****NEX	C22	Indexable insert
CNMG*****NFA	C20	Indexable insert



# Index

## C - D

CNMG*****NFB	C20	Indexable insert
CNMG*****NFE	C20	Indexable insert
CNMG*****NFL	C20	Indexable insert
CNMG*****NGE	C22	Indexable insert
CNMG*****NGU	C21	Indexable insert
CNMG*****NGU-W	C21	Indexable insert
CNMG*****NGZ	C25	Indexable insert
CNMG*****NLU	C20	Indexable insert
CNMG*****NLU-W	C20	Indexable insert
CNMG*****NME	C23	Indexable insert
CNMG*****NMU	C23	Indexable insert
CNMG*****NMX	C24	Indexable insert
CNMG*****NSE	C21	Indexable insert
CNMG*****NSE-W	C21	Indexable insert
CNMG*****NSU	C21	Indexable insert
CNMG*****NSX	C21	Indexable insert
CNMG*****NUG	C22	Indexable insert
CNMG*****NUP	C23	Indexable insert
CNMG*****NUX	C24	Indexable insert
CNMG*****NUZ	C25	Indexable insert
CNMM*****NHF	C26	Indexable insert
CNMM*****NHG	C26	Indexable insert
CNMM*****NHP	C26	Indexable insert
CNMM*****NHU	C27	Indexable insert
CNMM*****NHW	C27	Indexable insert
CNMM*****NMH	C26	Indexable insert
CNMM*****NMP	C26	Indexable insert
CNMX*****NF	M13	SUMIDIA insert
CNMX*****L/R	C26	Indexable insert
CNS****	P5	Spare parts
CNS****B	P5	Spare parts
CPB**	P7	Spare parts
CPB**S	P7	Spare parts
CPB**T	P7	Spare parts
CPGT*****NSD	C66	Indexable insert
CPGW*****NC2	M7	SUMIBORON insert
CP-M*_**_*	F20	Spare parts
CPM**N	P6	Spare parts
CPM**S	P6	Spare parts
CPMH*****NUS	C69	Indexable insert
CPMT*****NFB	C68	Indexable insert
CPMT*****NGU	C69	Indexable insert
CPMT*****NLB	C68	Indexable insert
CPMT*****NLU	C68	Indexable insert
CPMT*****NLU-W	C68	Indexable insert
CPMT*****NMU	C69	Indexable insert
CPMT*****NSU	C69	Indexable insert
CPMT*****NUS	C69	Indexable insert
CPMW*****NF	M7	SUMIDIA insert
CPU**C	P7	Spare parts
CPV**N	P6	Spare parts
CRDN N****_***	D26	Tool holder
CRSN R/L ****_***	D26	Tool holder
CSBN R/L ****_***	D25	Tool holder
CSKN R/L ****_***	D25	Tool holder
CTL*****N/L/R	F54	Indexable insert
CTR*****N/L/R NB	F54	Indexable insert
CTR*****N/L/R	F54	Indexable insert

## D

D***-DCLC R/L ****_**	E8	Boring bar
D***-DDUN R/L ****_**	E9	Boring bar
D***-DTFN R/L ****_**	E12	Boring bar
D***-DWLN R/L ****_**	E13	Boring bar
D***-SCLC R/L ****_**	E14	Boring bar
D***-SDQC R/L ****_**	E17	Boring bar
D***-SDUC R/L ****_**	E16	Boring bar
D***-STUP R/L ****_**	E20	Boring bar
D***-SVUB R/L ****_**	E21	Boring bar
D***-SVZB R/L ****_**	E21	Boring bar
DABB***C-R	M57	SUMIDIA-Bohrstange
DABB***N-R	M57	SUMIDIA-Bohrstange
DAL****H	M78	SUMIDIA-Bohrer
DC R/L-*	D25	Spare parts
DCGT*****LAY/RAY	C72	Indexable insert
DCGT*****LFX/RFX	C70	Indexable insert
DCGT*****LFX/RFX	C70	Indexable insert
DCGT*****LFY/RFY	C71	Indexable insert
DCGT*****LFY/RFY	C71	Indexable insert
DCGT*****LFYS/RFYS	C70	Indexable insert
DCGT*****LFYS/RFYS	C70	Indexable insert
DCGT*****LSD/RSD	C71	Indexable insert
DCGT*****M NFC	C70	Indexable insert
DCGT*****M NSC	C72	Indexable insert
DCGT*****M NSI	C72	Indexable insert
DCGT*****NAG	C71	Indexable insert
DCGT*****N-FV NC2	M14	SUMIBORON insert
DCGT*****N-FV NU2	M15	SUMIBORON insert
DCGT*****N-LV NC2	M14	SUMIBORON insert
DCGT*****N-LV NU2	M15	SUMIBORON insert
DCGT*****NSC	C72	Indexable insert
DCGW*****	C72	Indexable insert
DCGW*****HS-NC2	M14	SUMIBORON insert
DCGW*****HS-NU	M16	SUMIBORON insert
DCGW*****HS-NU2	M15	SUMIBORON insert
DCGW*****LE-NC2	M14	SUMIBORON insert
DCGW*****LE-NU2	M15	SUMIBORON insert
DCGW*****LF-NU	M16	SUMIBORON insert
DCGW*****LF-NU2	M15	SUMIBORON insert
DCGW*****LS-NC2	M14	SUMIBORON insert
DCGW*****LT-NU	M16	SUMIBORON insert
DCGW*****LT-NC2	M14	SUMIBORON insert
DCGW*****LU-NC2	M15	SUMIBORON insert
DCGW*****NC-2	M14	SUMIBORON insert
DCGW*****NC-WG2	M14	SUMIBORON insert
DCGW*****NC-WH2	M14	SUMIBORON insert
DCGW*****NS	M16	SUMIBORON insert
DCGW*****NU	M16	SUMIBORON insert
DCGW*****NU-2	M15	SUMIBORON insert
DCGW*****NU-WG2	M15	SUMIBORON insert
DCGW*****NU-WH2	M15	SUMIBORON insert
DCLN R/L ****_***	D12	Tool holder
DCMT*****	M17	SUMIDIA insert
DCMT*****L/R-DM NU	M17	SUMIDIA insert
DCMT*****NF	M17	SUMIDIA insert
DCMT*****NFB	C73	Indexable insert
DCMT*****NFP	C73	Indexable insert
DCMT*****NGD NF	M17	SUMIDIA insert
DCMT*****NGU	C73	Indexable insert
DCMT*****NLD NF	M17	SUMIDIA insert
DCMT*****NLB	C73	Indexable insert

DCMT*****NLU	C73	Indexable insert
DCMT*****NMU	C73	Indexable insert
DCMT*****NSK	C73	Indexable insert
DCMT*****NSU	C73	Indexable insert
DCMW*****	C73	Indexable insert
DCMW*****NF	M17	SUMIDIA insert
DCMW*****RH	M17, M45	SUMIDIA insert
DCMX**T***NLUW	C73	Indexable insert
DCS**T*	P5	Spare parts
DDHN R/L ****_***	D13	Tool holder
DDJN R/L ****_***	D13	Tool holder
DDL***V	M78	SUMIDIA drill
DDNN N ****_***	D13	Tool holder
DFC*****E	H16, H17	Indexable endmill
DFC*****E**	H17	Indexable endmill
DFCM*****E	H16, H17	Indexable endmill
DFCM*****E**	H17	Indexable endmill
DFC*****RS	G24, H16	Cutter
DFCF*****RS	G24, H16	Cutter
DFCM*****RS	G24, H16	Cutter
DGC*****EW	H6	Indexable endmill
DGC*****RS	G8	Cutter
DGCF*****RS	G8	Cutter
DGCM*****RS	G8	Cutter
DGCS**R	P5	Spare parts
DML***V	M79	SUMIDIA drill
DMSW*****E	H8	Indexable endmill
DMSW*****EL	H8	Indexable endmill
DMSW*****M	H9	Indexable endmill
DMSW*****R	G63, G66	Cutter
DMSW*****RS	G63, G66	Cutter
DNGA*****	C34	Indexable insert
DNGA*****ES-NC2	M19	SUMIBORON insert
DNGA*****ES-NC4	M19	SUMIBORON insert
DNGA*****HS-NC2	M19	SUMIBORON insert
DNGA*****HS-NC4	M19	SUMIBORON insert
DNGA*****HS-NU2	M20	SUMIBORON insert
DNGA*****LE-NC2	M18	SUMIBORON insert
DNGA*****LF-NU2	M20	SUMIBORON insert
DNGA*****LS-NC2	M19	SUMIBORON insert
DNGA*****LS-NC4	M19	SUMIBORON insert
DNGA*****LT-NC2	M18	SUMIBORON insert
DNGA*****LT-NU2	M20	SUMIBORON insert
DNGA*****NC-2	M18	SUMIBORON insert
DNGA*****NC-4	M18	SUMIBORON insert
DNGA*****NC-WG4	M18	SUMIBORON insert
DNGA*****NC-WH4	M18	SUMIBORON insert
DNGA*****NU	M20	SUMIBORON insert
DNGA*****NU-2	M20	SUMIBORON insert
DNGA*****NU-WG2	M20	SUMIBORON insert
DNGA*****NU-WH2	M20	SUMIBORON insert
DNGG*****LAX/RAX	C36	Indexable insert
DNGG*****LUM/RUM	C36	Indexable insert
DNGG*****NEF	C36	Indexable insert
DNGG*****NFV NC4	M19	SUMIBORON insert
DNGG*****NLV NC4	M19	SUMIBORON insert
DNGG*****NGH	C36	Indexable insert
DNGG*****NSU	C36	Indexable insert
DNGG*****N-SV NC4	M19	SUMIBORON insert
DNGM*****N-LV NU2	M20	SUMIBORON insert
DNGA*****	M21	SUMIBORON insert
DNGN*****	M21	SUMIBORON insert
DNMA*****	C35	Indexable insert
DNMA*****	M21	SUMIBORON insert
DNMA*****NF	M21	SUMIDIA insert
DNMA*****NS	M21	SUMIBORON insert
DNMA*****NU	M21	SUMIBORON insert
DNMA*****RH	M21, M45	SUMIDIA insert
DNMG*****LHM/RHM	C33	Indexable insert
DNMG*****LUM/RUM	C32	Indexable insert
DNMG*****NEF	C30	Indexable insert
DNMG*****NEG	C31	Indexable insert
DNMG*****NEM	C32	Indexable insert
DNMG*****NEX	C31	Indexable insert
DNMG*****NFA	C29	Indexable insert
DNMG*****NFB	C29	Indexable insert
DNMG*****NFE	C29	Indexable insert
DNMG*****NFL	C29	Indexable insert
DNMG*****NGE	C31	Indexable insert
DNMG*****NGU	C30	Indexable insert
DNMG*****NGZ	C33	Indexable insert
DNMG*****NLU	C29	Indexable insert
DNMG*****NME	C32	Indexable insert
DNMG*****NMU	C32	Indexable insert
DNMG*****NMX	C33	Indexable insert
DNMG*****NSE	C30	Indexable insert
DNMG*****NSU	C30	Indexable insert
DNMG*****NSX	C30	Indexable insert
DNMG*****NUG	C31	Indexable insert
DNMG*****NUP	C32	Indexable insert
DNMG*****NUX	C33	Indexable insert
DNMG*****NUZ	C33	Indexable insert
DNMM*****NHG	C34	Indexable insert
DNMM*****NHP	C34	Indexable insert
DNMM*****NMP	C34	Indexable insert
DNMX*****L/R	C35	Indexable insert
DNMX*****NSE-W	C35	Indexable insert
DNS***	P5	Spare parts
DNS****B	P5	Spare parts
DNX**** RS	G14	Cutter
DNXF**** RS	G14	Cutter
DNXK**R	G14	Spare parts
DSBN R/L ****_***	D14	Tool holder
DSDN N ****_***	D14	Tool holder
DSLX*	D27	Spare parts
DSP*	D25	Spare parts
DTFN R/L ****_***	D15	Tool holder
DTGN R/L ****_***	D15	Tool holder
DTJN R/L ****_***	D15	Tool holder
DTR**C R/L ****_***	D11	Tool holder
DTR**Q R/L ****_***	D11	Tool holder
DVJN R/L ****_***	D16	Tool holder
DVQN R/L ****_***	D16	Tool holder
DVVN N ****_***	D16	Tool holder
DWLN R/L ****_***	D17	Tool holder

# Index

## E - H

### E

ECXA***X**LE NU*	M51	SUMIBORON insert
ECXA***X**LF NU*	M51	SUMIBORON insert
E**D*SEXCR/L**-*P	M51	Boring bar
EHBX****	P3	Spare parts
EHHM****ZX	J31	Solid endmill
EPMS****U**R**	J23	Solid endmill
ER**	P6	Spare parts
E***SSHM N*****	F43	Tool holder

### F

FBUP*-A*.*	P3	Spare parts
FMJ	P4	Spare parts
FMU****R-S	G85, M73	Cutter
FMUE	G85, M73	Spare parts
FMUJ	P4	Spare parts
FMUU	G85, M73	Spare parts

### G

GCG N**** GA	F19, F21, F23, F25, F27, F29, F31, Indexable insert	
	F35, F37, F39, F47, F49	
GCM N**** GF	F19, F21, F23, F25, F27, F29, F31, Indexable insert	
	F35, F37, F39, F47, F49	
GCM N**** GF	F19, F21, F23, F25, F29, F37	Indexable insert
GCM N**** GG	F19, F21, F23, F25, F27, F29, F31, Indexable insert	
	F35, F37, F39, F47, F49	
GCM N**** GL	F19, F21, F23, F25, F27, F29, F31, Indexable insert	
	F35, F37, F39, F47, F49	
GCM N**** MG	F19, F21, F23, F25, F27, F29, F31, Indexable insert	
	F35, F37, F39, F47, F49	
GCM N**** ML	F19, F21, F23, F25, F27, F29, F31, Indexable insert	
	F35, F37, F39, F47, F49	
GCM N**** RG	F19, F21, F23, F25, F27, F29, F31, Indexable insert	
	F35, F37, F39, F47	
GCM N**** RN	F19, F21, F23, F25, F27, F29, F31, Indexable insert	
	F33, F37, F39, F47, F49	
GCM R/L **** CF**	F19, F21, F23, F25, F27, F29, F31, Indexable insert	
	F47	
GCM R/L **** CG**	F19, F21, F23, F25, F27, F29, F31, Indexable insert	
	F47	
GNDCF R/L ***_***	F48	Cassette
GNDCM R/L ***	F46	Cassette
GNDM R/L ****JX***	F18	Tool holder
GNDM R/L ****JX****	F18	Tool holder
GNDM R/L ****JX*****	F18	Tool holder
GNDM R/L ****JX***J	F20	Tool holder
GNDM R/L ****JX****J	F20	Tool holder
GNDM R/L ****JX*****J	F20	Tool holder
GNDM R/L ****K***	F24	Tool holder
GNDM R/L ****K****	F24	Tool holder
GNDM R/L ****K*****	F24	Tool holder
GNDM R/L ****M***	F24	Tool holder
GNDM R/L ****M****	F24	Tool holder
GNDM R/L ****M*****	F24	Tool holder
GNDM R/L ****P***	F24	Tool holder
GNDM R/L ****X***JE	F26, F30	Tool holder
GNDMS R/L ****K***	F24	Tool holder
GNDMS R/L ****M***	F24	Tool holder

GNDL R/L ****JX***	F18	Tool holder
GNDL R/L ****JX****	F18	Tool holder
GNDL R/L ****JX*****	F18	Tool holder
GNDL R/L ****K***	F28	Tool holder
GNDL R/L ****K****	F28	Tool holder
GNDL R/L ****K*****	F28	Tool holder
GNDL R/L ****M***	F28	Tool holder
GNDL R/L ****M****	F28	Tool holder
GNDL R/L ****M*****	F28	Tool holder
GNDL R/L ****P***	F28	Tool holder
GNDLS R/L ****K***	F28	Tool holder
GNDLS R/L ****M***	F28	Tool holder
GNDF R/L ****K***_***	F34	Tool holder
GNDF R/L ****M***_***	F34	Tool holder
GNDFS R/L ****M***_***	F36	Tool holder
GNDFS R/L ****P***_***	F36	Tool holder
GNDI R/L ****T***	F38	Tool holder
GNDIS R/L ****T****	F40	Tool holder
GNDN R/L ****K***_***	F32	Tool holder
GNDN R/L ****M***_***	F32	Tool holder
GND S R/L ****K***	F22	Tool holder
GND S R/L ****M***	F22	Tool holder
GSP*	M56	Spare parts
GSP**	D27, M54	Spare parts
GSH****SF	J28	Solid endmill
GSRE****SF	J27	Solid endmill
GSX****C-***D	J7, J12, J15	Solid endmill
GSX****C-*D	J9, J10, J11, J13, J17, J18, J19	Solid endmill
GSX****S-*D	J8, J16	Solid endmill
GSXB*****	J34	Solid endmill
GSXSLT****C-***D	J14	Solid endmill
GSXVL****_***D	J20	Solid endmill
GSXVL****S-R**_***D	J21	Solid endmill
GSXVL****-R**_***D	J21	Solid endmill
GSXVL****S-***D	J20	Solid endmill
GW B R/L ****_***	M54	Tool holder
GWBCM R/L **	M55	Cassette
GW C R/L ****_**	F50	Tool holder
GWCCM R/L **	F51	Cassette
GWCI R/L ***	F51	Tool holder
GWCS R/L ****_**	F50	Tool holder
GXM N**** S ML	F41	Indexable insert
GXM N**** S GF	F41	Indexable insert
GXM N***** S GF	F41	Indexable insert

### H

HBB***	M52, M57	Tool holder
HBB****	M57	Tool holder
HBSM****	M50, M51	Boring bar
HD***	P8	Spare parts
HE*****E	P5	Spare parts
HE*****P	P7	Spare parts
HE*****W	E13	Spare parts
HFJ	G79, G81, H85, H87, M63, M65, M67, M69	Spare parts
HFVT	G79, G81, H85, H87, M63, M65, M67, M69	Spare parts
HPL ****	P7	Spare parts
HPS****	P7	Spare parts

# Index

## J - P

### J

J-G1/8-G1/8-**	F21	Parts
J-G1/8-G1/8-**E	F21, F26, F30	Parts
J-G1/8-G1/8F-**E	F21, F26, F30	Parts
J-HOSE-G1/8-G1/8***-E	F21, F26, F30	Parts

### K

KGBS****	P4	Spare parts
KSS****	P4	Spare parts

### L

LCL*	P4	Spare parts
LCL**	P4	Spare parts
LCL*C-SD	P4	Spare parts
LCL*D-SD	P4	Spare parts
LCL*DB-SD	P4	Spare parts
LCL*S	P4	Spare parts
LCL*-SD	P4	Spare parts
LCL*T-SD	P4	Spare parts
LCS*	P4	Spare parts
LCS**	P4	Spare parts
LCS**BS-SD	P4	Spare parts
LCS*B-SD	P4	Spare parts
LCS*CA	P4	Spare parts
LCS*DB-SD	P4	Spare parts
LCS*TB-SD	P4	Spare parts
LCS*TE	P4	Spare parts
LH***	P8	Spare parts
LH****K	P8	Spare parts
LHHM****ZX	J31	Solid endmill
LNEX*****PNER-G	G33, G34, G35, H18, H19	Indexable insert
LNEX*****PNER-H	G33, G35, H18, H19	Indexable insert
LNEX*****PNER-L	G33, G34, G35, H18, H19	Indexable insert
LP**	P7	Spare parts
LSC**SD	P5	Spare parts
LSD**SD	P5	Spare parts
LSP*D	D34	Spare parts
LSP*	P7	Spare parts
LSP**	P7	Spare parts
LSP*SD	P7	Spare parts
LSR**	P5	Spare parts
LSR***	P5	Spare parts
LSS**SD	P5	Spare parts
LST**SD	P5	Spare parts
LST**SD	P5	Spare parts
LSTE**.*	P5	Spare parts
LSW***	P6	Spare parts
LT**	P8	Spare parts
LT**.*	P8	Spare parts
LT**IP	P8	Spare parts
LT**K	P8	Spare parts

### M

M*	H5	Spare parts
M**	H5	Spare parts
MA**M**L***C	H5	Tool holder
MA**M**L***S	H5	Tool holder
MDF****S2D	K26	Multi-drill
MDF****L2D	K27	Multi-drill
MDF****H3D	K29, K30	Multi-drill
MDF****H5D	K29, K30	Multi-drill
MDS****SDC*	K41	Multi-drill
MDS****	K40	Multi-drill
MDUS*****C	K40	Multi-drill
MDW****GS*	K22, K23	Multi-drill
MDW****NHGS	K36, K37	Multi-drill
MDW****PHT	K34, K35	Multi-drill
MDW***XHG-S**HAK	K34	Multi-drill
MDW***XHT-A**HAK	K35	Multi-drill
MIB*.*	P4	Spare parts
MLDH****L**	K39	Multi-drill
MLDH****P	K39	Multi-drill
MMW**	D23	Spare parts
MP**	P7	Spare parts
MSX****EM	H11	Indexable endmill
MSX****ES	H11	Indexable endmill
MSX****EW	H11	Indexable endmill
MSX****M**Z*	H12	Indexable endmill
MSX****RS	G67	Cutter
MTIX****E**	H69	Indexable endmill
MTIX****E****	H69	Indexable endmill
MTIX****RS**	G61	Cutter
MTJN R/L ****_**	D23	Tool holder
MTJN R/L V_**	D23	Tool holder
MTXN R/L ****_**	D23	Tool holder
MWLN R/L ****_***	D24	Tool holder
MWW**	D24	Spare parts

### N

NPDB****_***	J43, M77	SUMIDIA endmill
NPDBS****_***	J43, M77	SUMIDIA endmill
NPDRS****R****_***	J42, M76	SUMIDIA endmill

### O

ONEU****ANER L	G9, H6	Indexable insert
ONEU****ANER G	G9, H6	Indexable insert
ONMU****ANER L	G9, H6	Indexable insert
ONMU****ANER G	G9, H6	Indexable insert

### P

P*	G85, M73	Spare parts
PCBN R/L ****_***	D18	Tool holder
PCLC R/L ****_***	D31	Tool holder
PCLN R/L ****_***	D18	Tool holder
PCT***D*S**	K67	Multi-drill
PDJC R/L ****_***	D32	Tool holder
PDJN R/L ****_***	D19	Tool holder
PDL***D*S**	K67	Multi-drill



# Index

## P - S

### P

PRDC N****_***	D34	Tool holder
PRGC R/L ****_***	D34	Tool holder
PSBN R/L ****_***	D20	Tool holder
PSC**DCLN R/L *****-12	D41	Polygon tool holder
PSC**DDJN R/L *****-15	D41	Polygon tool holder
PSC**DDHN R/L *****-15	D41	Polygon tool holder
PSC**DSBN R/L *****-12	D41	Polygon tool holder
PSC**DTJN R/L *****-16	D42	Polygon tool holder
PSC**DWLN R/L *****-0*	D42	Polygon tool holder
PSC**GM** R/L****	F46, F48, M55	Polygon modular tool holder
PSC**SCLC R/L *****-09	D43	Polygon tool holder
PSC**SDJC R/L *****-11	D43	Polygon tool holder
PSC**SDHC R/L *****-11	D43	Polygon tool holder
PSC**SSBC R/L *****-12	D43	Polygon tool holder
PSC**STJC R/L *****-16	D44	Polygon tool holder
PSC**SVJB R/L *****-16	D44	Polygon tool holder
PSC**SVVB R/L *****-16	D44	Polygon tool holder
PSC**SVHB R/L *****-16	D44	Polygon tool holder
PSC**SVJC R/L *****-16	D45	Polygon tool holder
PSC**SVVC R/L *****-16	D45	Polygon tool holder
PSC**SVHC R/L *****-16	D45	Polygon tool holder
PSDN N ****_***	D20	Tool holder
PSKN R/L ****_***	D21	Tool holder
PSSN R/L ****_***	D21	Tool holder
PTFN R/L ****_***	D22	Tool holder
PTGN R/L ****_***	D22	Tool holder
PTTN R/L ****_***	D22	Tool holder
PW*	F63	Spare parts
PWLN R/L ****_***	D24	Tool holder
PWSS*R	P6	Spare parts

### Q

QPET*****PPFR-S	G16, H74, H75	Indexable insert
QPMT*****PPEN	G16, H74, H75	Indexable insert
QPMT*****PPEN-CP	G16	Indexable insert
QPMT*****PPEN-H	G16, H74, H75	Indexable insert

### R

RCMT***M0 NRH	C74	Indexable insert
RCMT***M0 NRX	C74	Indexable insert
RCMX***M0 NRP	C74	Indexable insert
RDET**T*M0EN-G	G21, H76, H77	Indexable insert
RDET**T*M0EN-H	G21, H76, H77	Indexable insert
RDET***M0EN-G	G21, H76, H77	Indexable insert
RDET***M0EN-H	G21, H76, H77	Indexable insert
RF-SET	G82, G85, M70, M73	Spare parts
RF****RS	G82, M70	Cutter
RFB	G82, M70	SUMIDIA insert
RFBW	G82, M70	SUMIDIA insert
RFC	G82, M70	Spare parts
RFD	G82, M70	Spare parts
RFF	G82, M70	Spare parts
RFJ	P4	Spare parts
RFR	G82, M70	Spare parts
RFS	G82, M70	Spare parts
RNGN*****	M22	SUMIBORON insert
RNGN*****B	M22	SUMIBORON insert

RSX****ES	G18, H76	Indexable endmill
RSXF****ES	G18, H76	Indexable endmill
RSX****M	G18, H77	Indexable endmill
RSXF****M	G18, H77	Indexable endmill
RSX****RS	G18, G20	Cutter
RSXF****RS	G18, G20	Cutter

### S

S**_DTR**C-R/L-**	E11	Boring bar
S**_MWLN R/L **	E13	Boring bar
S**_PCLN R/L **	E8	Boring bar
S**_PDUN R/L **	E9	Boring bar
S**_PSKN R/L **	E10	Boring bar
S**_PTFN R/L **	E12	Boring bar
S**_SCLC R/L **	E14	Boring bar
S**_SCLP R/L **	E15	Boring bar
S**_SDQC R/L **	E17	Boring bar
S**_SDUC R/L **	E16	Boring bar
S**_SSKP R/L **	E18	Boring bar
S**_STFC R/L **	E19	Boring bar
S**_STUB R/L **_**	E20	Boring bar
S**_STUP R/L **	E20	Boring bar
S**_STUP R/L **_**	E20	Boring bar
S**_SVQB R/L **	E22	Boring bar
S**_SVUB R/L **	E22	Boring bar
S**_SVZB R/L **	E23	Boring bar
S**_SWUB R/L **	D11, E11	Boring bar
SBN*_**	F56, F58	Tool holder
SBU*_**	F56, F58	Tool holder
SCAC R/L ****_***	D31	Tool holder
SCGT**T**LFX/RFX	C75	Indexable insert
SCGT*****M NSC	C75	Indexable insert
SCGW*****NU	M19	SUMIBORON insert
SCLC R/L ****_***	D31	Tool holder
SCMT*****NFB	C76	Indexable insert
SCMT*****NFP	C76	Indexable insert
SCMT*****NGU	C76	Indexable insert
SCMT*****NLB	C76	Indexable insert
SCMT*****NLU	C76	Indexable insert
SCMT*****NMU	C76	Indexable insert
SCMT*****NSK	C76	Indexable insert
SCMT*****NSU	C76	Indexable insert
SCMW*****	C76	Indexable insert
SCN****	P5	Spare parts
SCND***	P5	Spare parts
SCP*^	D12, D13, D14, D15, D16, D17, Spare parts	
	D41, D42, E8, E9, E12, E13	
SCP*A	F51, M55	Spare parts
SCS****	P5	Spare parts
SCT R/L ****	F54	Tool holder
SCW***	P5	Spare parts
SDAC R/L ****_***	D33	Tool holder
SDBSM	M51	Spare parts
SDET****ZDFR	G82, M70	Indexable insert
SDHC R/L ****_***	D32	Tool holder
SDJC R/L ****_***	D32	Tool holder
SDM****U*HAK	K17, K18, K19	Multi-drill
SDNC N ****_***	D33	Tool holder
SDP****U*HAK	K8, K9, K10, K10, K11	Multi-drill
SDW***	P5	Spare parts

SEET****AGFR-L	G11, H7	Indexable insert
SEET****AGSR-L	G11, H7	Indexable insert
SEET****AGSR-G	G11, H7	Indexable insert
SEMT****AGSR-L	G11, H7	Indexable insert
SEMT****AGSR-G	G11, H7	Indexable insert
SEMT****AGSR-H	G11, H7	Indexable insert
SEMT****AGSR-FG	G11, H7	Indexable insert
SFKN****AZFN	G13	Indexable insert
SFKN****AZTN	G13	Indexable insert
SFKR****AZTN	G13	Indexable insert
SFW***	P5	Spare parts
SL-*	F56, F58, F59	Spare parts
SMDH****S/M/L/D*	K44, K48,	Multi-drill
SMDT****MFS	K49	Indexable insert
SMDT****MTL	K51	Indexable insert
SMDT****D MEL	K46	Indexable insert
SMDT****D MTL	K45	Indexable insert
SNB****DL	J35	Solid endmill
SNEU****ANER-FG	G9, H6	Indexable insert
SNEU****ANER-FL	G9, H6	Indexable insert
SNEU****ANER-G	G9, H6	Indexable insert
SNEU****ANER-L	G9, H6	Indexable insert
SNEW****ADFR-NF	G66, M70	SUMIDIA insert
SNEW****ADFR-W-NF	G66, M70	SUMIDIA insert
SNEW****ADTR-NF	G67, M71	SUMIDIA insert
SNEW****ADTR-R-NF	G67, M71	SUMIDIA insert
SNEW****ADTR-U-NF	G67, M71	SUMIDIA insert
SNEW****ADT L/R	G69, M73	SUMIBORON insert
SNEW****ADT L/R-S	G69, M73	SUMIBORON insert
SNGA*****	C44	Indexable insert
SNGA*****HS-NC2	M23	SUMIBORON insert
SNGA*****HS-NU2	M23	SUMIBORON insert
SNGA*****LT-NU2	M23	
SNGA*****NC2	M23	SUMIBORON insert
SNGA*****NC4	M23	SUMIBORON insert
SNGA*****NU2	M23	SUMIBORON insert
SNGA*****NU4	M23	SUMIBORON insert
SNGG*****LAX/RAX	C44	Indexable insert
SNGG*****LST/RST	C44	Indexable insert
SNGG*****LUM/RUM	C44	Indexable insert
SNGN*****	C45	Indexable insert
SNGN*****	M24	SUMIBORON insert
SNGX*****	M24	SUMIBORON insert
SNMA*****	C44	Indexable insert
SNMA*****NS	M24	SUMIBORON insert
SNMA*****NU	M24	SUMIBORON insert
SNMA*****NF	M24	SUMIDIA insert
SNMA*****RH	M24, M45	SUMIDIA insert
SNMG*****LUM/RUM	C39	Indexable insert
SNMG*****LHM/RHM	C41	Indexable insert
SNMG*****NEF	C38	Indexable insert
SNMG*****NEG	C39	Indexable insert
SNMG*****NEM	C40	Indexable insert
SNMG*****NEX	C39	Indexable insert
SNMG*****NFB	C37	Indexable insert
SNMG*****NFE	C37	Indexable insert
SNMG*****NFL	C37	Indexable insert
SNMG*****NGE	C38	Indexable insert
SNMG*****NGU	C38	Indexable insert
SNMG*****NGZ	C41	Indexable insert
SNMG*****NLU	C37	Indexable insert
SNMG*****NME	C40	Indexable insert
SNMG*****NMU	C40	Indexable insert
SNMG*****NMX	C41	Indexable insert
SNMG*****NSE	C37	Indexable insert
SNMG*****NSJ	C38	Indexable insert
SNMG*****NSU	C37	Indexable insert
SNMG*****NSX	C38	Indexable insert
SNMG*****NUG	C39	Indexable insert
SNMG*****NUP	C39	Indexable insert
SNMG*****NUX	C40	Indexable insert
SNMG*****NUZ	C41	Indexable insert
SNMN*****	C45	Indexable insert
SNMM*****NHF	C43	Indexable insert
SNMM*****NHG	C42	Indexable insert
SNMM*****NHGS	C42	Indexable insert
SNMM*****NHP	C42	Indexable insert
SNMM*****NHU	C43	Indexable insert
SNMM*****NHW	C43	Indexable insert
SNMM*****NMH	C42	Indexable insert
SNMM*****NMP	C42	Indexable insert
SNMT****ZNEN-G	G15	Indexable insert
SNMT****ZNEN-H	G15	Indexable insert
SNMT****ZNEN-L	G15	Indexable insert
SNMT****ZNEN-SH	G15	Indexable insert
SNMU****ANER FG	G9, H6	Indexable insert
SNMU****ANER FL	G9, H6	Indexable insert
SNMU****ANER G	G9, H6	Indexable insert
SNMU****ANER H	G9, H6	Indexable insert
SNMU****ANER L	G9, H6	Indexable insert
SNS****	P5	Spare parts
SOET*****PDFR-S	G26, G29, G71, H15, H19, H79, H80	Indexable insert
SOET*****PZER-G	G26, G28, G70, H15, H18, H79, H80	Indexable insert
SOET*****PZFR-S	G26, G28, G70, H15, H18, H79, H80	Indexable insert
SOMT*****PDER-L	G26, G29, G71, H15, H19, H79, H80	Indexable insert
SOMT*****PDER-G	G26, G29, G71, H15, H19, H79, H80	Indexable insert
SOMT*****PDER-H	G26, G29, G71, H15, H19, H79, H80	Indexable insert
SOMT*****PZER-L	G26, G28, G70, H15, H18, H79, H80	Indexable insert
SOMT*****PZER-G	G26, G28, G70, H15, H18, H79, H80	Indexable insert
SOMT*****PZER-H	G26, G28, G70, H15, H18, H79, H80	Indexable insert
SPGN*****	C79	Indexable insert
SPGT*****LSD/RSD	C78	Indexable insert
SPGW*****	C78	Indexable insert
SPGW*****T	C78	Indexable insert
SPMH*****NUS	C77	Indexable insert
SPMN*****	C79	Indexable insert
SPMR*****NFK	C79	Indexable insert
SPMR*****NSF	C79	Indexable insert
SPMR*****NUJ	C79	Indexable insert
SPMT*****	C39, H71	Indexable insert
SPMT*****NFB	C77	Indexable insert
SPMT*****NFK	C77	Indexable insert
SPMT*****NLB	C77	Indexable insert
SPMT*****NLU	C77	Indexable insert
SPMT*****NSF	C77	Indexable insert



# Index

## S - T

SPMT*****NUS	C77	Indexable insert
SPP*	P7	Spare parts
SPP**	P7	Spare parts
SRDC N ****_***	D35	Tool holder
SRF**R-ST	G83, M71	Cutter
SRF**RS	G83, M71	Cutter
SRFJ	P4	Spare parts
SRND**	P5	Spare parts
SRNS***SD	D35	Spare parts
SRSC R/L ****_***	D35	Tool holder
SSBC R/L ****_***	D36	Tool holder
SSEH***R**	J37	Solid endmill
SSEH***W-R**	J26	Solid endmill
SSEH***WS-R**	J26	Solid endmill
SSEHVL ****-R**	J37	Solid endmill
SSEHVL ****W-R**	J25	Solid endmill
SSEHVL ****WS-R**	J25	Solid endmill
SSHC R/L*****	F43	Indexable insert
SSHG R/L*****	F43, F44	Indexable insert
SSHR R/L*****	F43, F44	Indexable insert
SSM****	J38, J39	Solid endmill
SSND***	P5	Spare parts
SSTE R*****	F63	Tool holder
SSTI R*****	F63	Tool holder
SSUP****ZX	J33	Solid endmill
SSUP****ZX-R**	J33	Solid endmill
SSW***	P6	Spare parts
STAC R/L ****_***	D37	Tool holder
STFH**_*	F56	Tool holder
STFS R/L ****_*	F56	Tool holder
STGC R/L ****_***	D37	Tool holder
STPD***	P6	Spare parts
STW***	P6	Spare parts
SUF*S R/L	G12	Spare parts
SVJB R/L ****_***	D38	Tool holder
SVLC R/L ****_***	D39	Tool holder
SVP**	D38, E21, E22	Spare parts
SVPB R/L ****_***	D38	Tool holder
SVPC R/L ****_***	D39	Tool holder
SVVB N ****_***	D38	Tool holder
SVW***	P5	Spare parts
SWW	P6	Spare parts

## T

TBGN*****	C88	Indexable insert
TBGN*****B	M25	SUMIBORON insert
TBGN*****NF	M25	SUMIDIA insert
TBGR*****LW	C88	Indexable insert
TBGT*****LAY/RAY	C80	Indexable insert
TBGT*****LFW/RFW	C80	Indexable insert
TBGT*****LFX/RFX	C80	Indexable insert
TBGT*****LFY/RFY	C80	Indexable insert
TBGT*****LW/RW	C80	Indexable insert
TBGW*****	C80	Indexable insert
TBGW*****NF	M25	SUMIDIA insert
TCGT*****LFX/RFX	C81	Indexable insert
TCGT*****LFY/RFY	C81	Indexable insert
TCGT*****M NSC	C81	Indexable insert
TCGT*****M NSI	C81	Indexable insert
TCGT*****NAG	C81	Indexable insert

TCGW*****NC	M26	SUMIBORON insert
TCGW*****NC-3	M26	SUMIBORON insert
TCGW*****NU	M26	SUMIBORON insert
TCMT*****NF	M26	SUMIDIA insert
TCMT*****NFB	C82	Indexable insert
TCMT*****NFP	C82	Indexable insert
TCMT*****NLB	C82	Indexable insert
TCMT*****NLU	C82	Indexable insert
TCMT*****NSK	C82	Indexable insert
TCMT*****NSU	C82	Indexable insert
TCMW*****	C82	Indexable insert
TCS**T*	P6	Spare parts
TEGN*****	C89	Indexable insert
TGA R/L ****BF	F51	Indexable insert
TGA R/L ****(E)	F52	Indexable insert
TGA R/L ****R	F53	Indexable insert
TGA R/L *T**	F53	Indexable insert
TF**	M42	Spare parts
TH**	P8	Spare parts
TNGA*****	C54	Indexable insert
TNGA*****ES-NC6	M27	SUMIBORON insert
TNGA*****HS-NC3	M27	SUMIBORON insert
TNGA*****HS-NC6	M27	SUMIBORON insert
TNGA*****HS-NU3	M29	SUMIBORON insert
TNGA*****HT-NU3	M29	SUMIBORON insert
TNGA*****LE-NC3	M27	SUMIBORON insert
TNGA*****LE-NU3	M29	SUMIBORON insert
TNGA*****LS-NC3	M27	SUMIBORON insert
TNGA*****LS-NU3	M29	SUMIBORON insert
TNGA*****LT-NC3	M27	SUMIBORON insert
TNGA*****LF-NU3	M29	SUMIBORON insert
TNGA*****NC3	M27	SUMIBORON insert
TNGA*****NC6	M27	SUMIBORON insert
TNGA*****NU3	M29	SUMIBORON insert
TNGA*****T NU3	M29	SUMIBORON insert
TNGA*****US-NU3	M29	SUMIBORON insert
TNGG*****LAX/RAX	C54	Indexable insert
TNGG*****LFT/RFT	C53	Indexable insert
TNGG*****LFY/RFY	C53	Indexable insert
TNGG*****LFX/RFX	C53	Indexable insert
TNGG*****LST/RST	C53	Indexable insert
TNGG*****LUM/RUM	C54	Indexable insert
TNGG*****N-FV NC6	M28	SUMIBORON insert
TNGG*****N-LV NC6	M28	SUMIBORON insert
TNGG*****NGH	C54	Indexable insert
TNGG*****NSU	C53	Indexable insert
TNGG*****N-SV NC6	M28	SUMIBORON insert
TNGM*****N-LV NU3	M29	SUMIBORON insert
TNGN*****	M29	SUMIBORON insert
TNMA*****	C52	Indexable insert
TNMA*****	M30	SUMIBORON insert
TNMA*****NU	M30	SUMIBORON insert
TNMA*****NS	M30	SUMIBORON insert
TNMG*****LHM/RHM	C50	Indexable insert
TNMG*****LUM/RUM	C48	Indexable insert
TNMG*****NEF	C46	Indexable insert
TNMG*****NEG	C48	Indexable insert
TNMG*****NEM	C49	Indexable insert
TNMG*****NEX	C48	Indexable insert
TNMG*****NFA	C46	Indexable insert
TNMG*****NFB	C46	Indexable insert
TNMG*****NFE	C46	Indexable insert



# Index

## V- W

V		
VBGT*****LAY/RAY	C91	Indexable insert
VBGT*****LFX/RFX	C91	Indexable insert
VBGT*****LFY/RFY	C91	Indexable insert
VBGT*****LFYS/RFYS	C91	Indexable insert
VBGT*****M NSI	C91	Indexable insert
VBGW*****HS-NC2	M37	SUMIBORON insert
VBGW*****HS-NU	M36	SUMIBORON insert
VBGW*****LE-NC2	M37	SUMIBORON insert
VBGW*****LE-NU2	M37	SUMIBORON insert
VBGW*****LS-NC2	M37	SUMIBORON insert
VBGW*****LT-NC2	M37	SUMIBORON insert
VBGW*****LT-NU	M36	SUMIBORON insert
VBGW*****NC	M36	SUMIBORON insert
VBGW*****NC2	M37	SUMIBORON insert
VBGW*****NU	M36	SUMIBORON insert
VBGW*****NU2	M37	SUMIBORON insert
VBMT*****NFB	C90	Indexable insert
VBMT*****NFP	C90	Indexable insert
VBMT*****NGU	C90	Indexable insert
VBMT*****NLB	C90	Indexable insert
VBMT*****NLU	C90	Indexable insert
VBMT*****NMU	C90	Indexable insert
VBMT*****NSK	C90	Indexable insert
VBMT*****NSU	C90	Indexable insert
VBMW*****	C90	Indexable insert
VCGT*****LFX/RFX	C92	Indexable insert
VCGT*****LFY/RFY	C92	Indexable insert
VCGT*****M NFC	C92	Indexable insert
VCGT*****M NSI	C92	Indexable insert
VCGT*****NAG	C92	Indexable insert
VCGW*****HS NC2	M38	SUMIBORON insert
VCGW*****LS NC2	M38	SUMIBORON insert
VCGW*****LT NU	M38	SUMIBORON insert
VCGW*****NC2	M38	SUMIBORON insert
VCGW*****NU	M38	SUMIBORON insert
VCMT*****	M39	SUMIDIA insert
VCMT*****NF	M39	SUMIDIA insert
VCMT*****NFB	C93	Indexable insert
VCMT*****NGU	C93	Indexable insert
VCMT*****NLD NF	M39	SUMIDIA insert
VCMT*****NGD NF	M39	SUMIDIA insert
VCMT*****NLB	C93	Indexable insert
VCMT*****NLU	C93	Indexable insert
VCMT*****NSK	C93	Indexable insert
VCMT*****NSU	C93	Indexable insert
VCMW*****	M39	SUMIBORON insert
VCMW*****NF	M39	SUMIDIA insert
VCMW*****RH	M39, M45	SUMIDIA insert
VCS****	P6	Spare parts
VNGA*****ES-NC4	M41	SUMIBORON insert
VNGA*****HS-NC4	M41	SUMIBORON insert
VNGA*****HS-NU2	M40	SUMIBORON insert
VNGA*****LS-NC2	M41	SUMIBORON insert
VNGA*****LS-NC4	M41	SUMIBORON insert
VNGA*****LT-NC2	M41	SUMIBORON insert
VNGA*****LT-NU2	M40	SUMIBORON insert
VNGA*****NC2	M41	SUMIBORON insert
VNGA*****NC4	M41	SUMIBORON insert
VNGA*****NU	M40	SUMIBORON insert
VNGA*****NU2	M40	SUMIBORON insert
VNGG*****LAX/RAX	C57	Indexable insert

VNGG*****NEF	C57	Indexable insert
VNGG*****NFV NC4	M41	SUMIBORON insert
VNGG*****NLV NC4	M41	SUMIBORON insert
VNGG*****NSU	C57	Indexable insert
VNGM*****NLV NU2	M42	SUMIBORON insert
VNMA*****	C55	Indexable insert
VNMA*****	M42	SUMIBORON insert
VNMA*****NU	M42	SUMIBORON insert
VNMA*****NS	M42	SUMIBORON insert
VNMA*****NF	M42	SUMIDIA insert
VNMA*****RH	M42, M45	SUMIDIA insert
VNMG*****NEF	C55	Indexable insert
VNMG*****NEG	C56	Indexable insert
VNMG*****NEX	C56	Indexable insert
VNMG*****NFA	C55	Indexable insert
VNMG*****NFB	C55	Indexable insert
VNMG*****NFE	C55	Indexable insert
VNMG*****NFL	C55	Indexable insert
VNMG*****NGE	C56	Indexable insert
VNMG*****NGU	C56	Indexable insert
VNMG*****NGZ	C57	Indexable insert
VNMG*****NLU	C55	Indexable insert
VNMG*****NSE	C56	Indexable insert
VNMG*****NSU	C56	Indexable insert
VNMG*****NSX	C56	Indexable insert
VNMG*****NUG	C56	Indexable insert
VNMG*****NUP	C57	Indexable insert
VNMG*****NUX	C57	Indexable insert
VNMG*****NUZ	C57	Indexable insert
VNMX*****	M42	SUMIDIA insert
VNMX*****NF	M42	SUMIDIA insert
VNS****	P6	Spare parts
VP**	P7	Spare parts
VP**B	P7	Spare parts

## W

WAS*****	K66	Eccentric sleeve
WAX****E**	H62, H63	Indexable endmill
WAX****EL**	H62, H63	Indexable endmill
WAX****RS	G72, G73	Cutter
WB*..*	P4	Spare parts
WB*..*T	P4	Spare parts
WB*F*..*T	P4	Spare parts
WB*..*TL	P4	Spare parts
WB*F*..*TL	P4	Spare parts
WB*R*..*T	P4	Spare parts
VBGT*****LFW/RFW	C94	Indexable insert
VBGT*****LFX/RFX	C94	Indexable insert
VBGT*****LFY/RFY	C94	Indexable insert
VBGT*****LW/RW	C94	Indexable insert
WBMF****L	H73	Indexable endmill
WBMF****M	H73	Indexable endmill
WBMF****MM**N	H73	Indexable endmill
WBMF****S	H73	Indexable endmill
WBMR****LL	H71	Indexable endmill
WBMR****LLW	H71	Indexable endmill
WBMR****M	H71	Indexable endmill
WBMR****MW	H71	Indexable endmill
WBMR****S	H71	Indexable endmill
WCFH**..*	F58, F59	Tool holder

# Index

## W - W

WCFN/R/L*	F57, F60	Indexable insert	WNGA*****LS-NC6	M43	SUMIBORON insert
WCFN/R/L*A	F57, F60	Indexable insert	WNGA*****LT-NC3	M43	SUMIBORON insert
WCFN/R/L*B	F57, F60	Indexable insert	WNGA*****NC6	M43	SUMIBORON insert
WCFN/R/L*T	F57, F60	Indexable insert	WNGA*****NC-WG6	M43	SUMIBORON insert
WCFN*GF	F57, F60	Indexable insert	WNGA*****NC-WH6	M43	SUMIBORON insert
WCFN*GG	F57, F60	Indexable insert	WNGG*****NSU	C60	Indexable insert
WCF R/L*CF	F57,	Indexable insert	WNMA*****	C62	Indexable insert
WCFS R/L **_*	F59	Tool holder	WNMA*****NU	M43	SUMIBORON insert
WDMT****ZDTR	G67, H11, H12	Indexable insert	WNMG*****NEF	C59	Indexable insert
WDMT****ZDTR-H	G67, H11, H12	Indexable insert	WNMG*****NEG	C60	Indexable insert
WDX***D2S**	K56	Multi-drill	WNMG*****NEM	C60	Indexable insert
WDX***D3S**	K58	Multi-drill	WNMG*****NEX	C60	Indexable insert
WDX***D4S**	K60	Multi-drill	WNMG*****NFA	C58	Indexable insert
WDX***D5S**	K62	Multi-drill	WNMG*****NFB	C58	Indexable insert
WDXT*****-G	K57, K59, K61, K63, K67	Indexable insert	WNMG*****NFE	C58	Indexable insert
WDXT*****-H	K57, K59, K61, K63, K67	Indexable insert	WNMG*****NFL	C58	Indexable insert
WDXT*****-L	K57, K59, K61, K63, K67	Indexable insert	WNMG*****NGE	C60	Indexable insert
WDXT*****-M	K57, K59, K61, K63	Indexable insert	WNMG*****NGU	C59	Indexable insert
WEX****E	H56, H57, H58	Indexable endmill	WNMG*****NGU-W	C59	Indexable insert
WEX****E**	H58	Indexable endmill	WNMG*****NGZ	C61	Indexable insert
WEX****EL	H56, H57, H58	Indexable endmill	WNMG*****NLU	C58	Indexable insert
WEX****EL**	H56, H57	Indexable endmill	WNMG*****NLU-W	C58	Indexable insert
WEX****EL**Z*	H57	Indexable endmill	WNMG*****NME	C61	Indexable insert
WEX****EW	H57, H58	Indexable endmill	WNMG*****NMU	C61	Indexable insert
WEX****F	G58	Cutter	WNMG*****NMX	C61	Indexable insert
WEX****M**Z*	H57, H58,	Indexable endmill	WNMG*****NSE	C59	Indexable insert
WEZ*****E**	G40, H26, H30, H36,	Indexable endmill	WNMG*****NSE-W	C59	Indexable insert
WEZ*****E***	G40, H26, H30, H36,	Indexable endmill	WNMG*****NSU	C59	Indexable insert
WEZ*****EL**	G40, H26, H34, H40,	Indexable endmill	WNMG*****NSX	C59	Indexable insert
WEZ*****ES****	G40, H26, H32, H38,	Indexable endmill	WNMG*****NUG	C60	Indexable insert
WEZ*****M***Z*	G40, H26, H46, H48	Indexable endmill	WNMG*****NUP	C60	Indexable insert
WEZ*****R**	G40, G44, G46, H26	Cutter	WNMG*****NUX	C61	Indexable insert
WEZ*****RS**	G40, G44, G46, H26	Cutter	WNMG*****NUZ	C61	Indexable insert
WEZR*****E***Z**	G40, H26, H42, H44	Indexable endmill	WNMM*****NHG	C62	Indexable insert
WEZR*****M***Z*	G40, H26, H50, H52	Indexable endmill	WNMM*****NMP	C62	Indexable insert
WEZR*****RS***Z**	G40, G54, G56, H26	Cutter	WNMU****ZNER-G	G66, H8, H9	Indexable insert
WFX*****E	G26, H18, H19	Indexable endmill	WNMU****ZNER-H	G66, H8, H9	Indexable insert
WFX*****R	G26	Cutter	WNS****	P6	Spare parts
WFX*****E**	H18	Indexable endmill	WNS****B	P6	Spare parts
WFXF*****E	G26, H19	Indexable endmill	WPMT*****NLB	C95	Indexable insert
WFXM*****E	G26, H18	Indexable endmill	WRCX****EL	H74	Indexable endmill
WFX*****M	G26	Indexable endmill	WRCX****EM	H74	Indexable endmill
WFX*****M**Z*	H18, H58	Indexable endmill	WRCX****ES	H74	Indexable endmill
WFX*****RS	G26, G28, G29	Cutter	WRCX****M**Z*	H75	Indexable endmill
WFXC*****E	G26, H78, H79	Indexable endmill	WRCX****RS	G17	Cutter
WFXC*****M	G26, H80	Indexable endmill	WRCXF****RS	G17	Cutter
WFXF*****R	G26	Cutter	WRCXX****RS	G17	Cutter
WFXF*****RS	G26, G28, G29	Cutter	WRX****RH**E**	H65, H66	Indexable endmill
WFXH*****M	G26, H14	Indexable endmill	WRX****RH**F**	G59	Cutter
WFXH*****M**Z*	H15	Indexable endmill	WRX****RH**W**	H65, H66	Indexable endmill
WFXH*****RS	G26, G70, G71	Cutter			
WFXH*****RSZ6	G70	Cutter			
WFXM*****R	G26	Cutter			
WFXM*****RS	G26, G28	Cutter			
WFXS*R	P6	Spare parts			
WGCS**R	P6	Spare parts			
WGX*****EW	H7	Indexable endmill			
WGX*****RS	G10	Cutter			
WGXF*****RS	G10	Cutter			
WGXM*****RS	G10	Cutter			
WNGA*****HS-NC6	M43	SUMIBORON insert			
WNGA*****LS-NC3	M43	SUMIBORON insert			

## X - Z

### X

XCLN R/L ****_***	D27	Tool holder
XEEW****AGER-W	G13	Indexable insert
XEEW****AGER-WR	G11, H7	Indexable insert
XEEW****AGFR-W-NF	G13	Indexable insert
XNEU****ANEN-W	G9, H6	Indexable insert
XNMU****PNER-G	G25, G27, H14, H15	Indexable insert
XNMU****PNER-GS	G25, H17	
XNMU****PNER-H	G25, G27, H14, H15	Indexable insert
XNMU****PNER-L	G25, G27, H14, H15	Indexable insert
XOEW*****PDTR-W	G31, H17	Indexable insert
XOEW*****PZTR-W	G30, H14	Indexable insert
XOMT****PEER-E	G61, H69	Indexable insert
XP**	F20	Spare parts
XP**-E	F26, F30	Spare parts
XSBN R/L ****_***	D27	Tool holder

### Y

YE*	P6	Spare parts
YI*	P6	Spare parts

### Z

ZNEX*****LE-NC	M44	SUMIBORON insert
ZNEX*****LT-NC	M44	SUMIBORON insert
ZNEX*****NC	M44	SUMIBORON insert
ZNEX*****NU	M44	SUMIBORON insert
ZNMT*****	H71	Indexable insert
ZNMT*****-C	H71	Indexable insert
ZNMT*****-N	H71	Indexable insert
ZNMT*****-S	H71	Indexable insert
ZPGU*****	H73	Indexable insert



# Sumitomo Electric Cutting Tools Official Apps

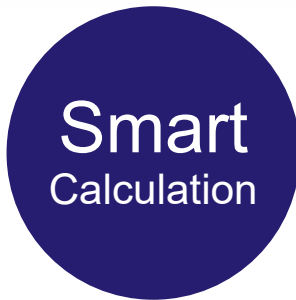

Just enter figures

Just select conditions

for iOS/Android



Cutting calculation app

## SumiTool Calculator



Grade and chipbreaker comparison app

## SumiTool Converter





# SAFETY INSTRUCTIONS

Target Products	Hazards	Measures
<b>General precautions for cutting tools</b>	The tools have sharp cutting edges. There is a risk of injury if held directly with bare hands.	Always wear protective equipment, such as protective tools when removing the tool from the case or mounting it onto a machine.
	Improper use or incorrect use conditions may cause the tool to break or scatter, and could cause injury.	Always use protective equipment such as safety covers and protective eyewear. Always use within the scope of the recommended conditions. Refer to the instruction manual, catalogue and other relevant documents.
	The tool could break and fly off if the cutting force increases suddenly because of impact loads or excessive wear and could cause injury.	Always use protective equipment such as safety covers and protective eyewear. Replace the tool at an early stage.
	Very hot chips could scatter or elongated chips could be discharged, and cause injury or burns.	Always use protective equipment such as safety covers and protective eyewear. When removing the chips, always stop the machine, wear protective gloves, and use tools such as nippers or clippers.
	The tool and work materials will become very hot during turning. There is a risk of burn if these are touched directly with bare hands immediately after machining.	Always wear protective equipment such as protective gloves.
	There is a risk of igniting or fires from the sparks generated during turning, or the heat generated from broken pieces and chips.	Do not use in an area where there is a risk of fires or explosions. Always provide fire prevention measures when using water-insoluble turning oil solution.
	When using at a high rotation speed, if the balance including the machine tool holder is poor, the deflection or vibration could cause tool damage and injury.	Always use protective equipment such as safety covers and protective eyewear. Always carry out trial operation, and confirm that there is no deflection, vibration or abnormal noise.
<b>General precautions for cutting edge indexable tools</b>	There is a risk of injury if you touch the burrs formed on the workpiece with bare hands.	Do not touch with bare hands.
	If insert or parts are not properly clamped, they could come off or fly off during turning and cause injury.	Clean the mounting surface and fixing parts free of foreign matter, before mounting the insert. When mounting, use the enclosed spanner and confirm that the insert and parts are securely clamped. Never use parts other than the designated inserts or parts.
	If the parts are tightened excessively with an auxiliary tool such as a pipe, the insert or part could break and come off or fly off.	Do not use auxiliary tools such as pipes. Use the enclosed spanner.
<b>Various cutters and other tools used with rotation</b>	Using the tool with high-speed rotation is extremely dangerous as the parts or inserts could fly off with the centrifugal force. Pay special attention to safety when handling.	Always use within the scope of the recommended conditions. Refer to the instruction manual, catalog and other relevant documents.
	The cutters have very sharp cutting edges. Touching these with bare hands could result in injury.	Always wear protective equipment such as protective gloves.
<b>Drills</b>	Tools could sway or vibrate if the eccentric rotation or balance is poor. There is a risk of injury if they break or fly off.	Keep the rotation speed within the scope of the recommended conditions. Periodically adjust the accuracy and balance of the rotating sections so that eccentric rotation or deflection do not occur because of bearing wear, etc.
	When machining a through hole while rotating the workpiece, a disc-shaped uncut section may fly off at the point of penetration. This disc is sharp and very dangerous.	Always use protective equipment such as safety covers and protective eyewear. Also take measures such as attaching a cover to the chuck section.
<b>Brazing tool</b>	The very small drill has a pointed end, and is very sharp. It could stab or break when directly touched with a finger, and be difficult to remove. The end could fly off if it breaks.	Take special care to safety when handling. Always wear protective gloves and protective eyewear, etc.
	There is a risk of injury if the insert comes off or breaks, etc.	Confirm that the insert is properly brazed before using. Do not use in conditions that could become very hot.
<b>Others</b>	Repeated brazing is dangerous as the insert could break during use.	Do not use an insert that has been repeatedly brazed as the strength will have dropped.
	Using this product for a purpose other than the designated application can break the machine or tool and is very dangerous.	Observe the designated usage.

Finally, this brochure describes the basic safety information. For further information, refer to the instruction manual, catalog and other relevant documents for each tool, or contact Sumitomo Electric Hardmetal. Sumitomo Electric Hardmetal will not be held liable for any damage and injuries resulting from changes to the specifications, including alterations and modifications, made without consent from Sumitomo Electric Hardmetal.

# Tool Engineering Services

In order to provide a higher level of support and satisfaction for our customers, Sumitomo Electric Industries has created the Tool Engineering Service system.

We have created several Tool Engineering Centers around the world as bases for this support. The Tool Engineering Centers provide a wide range of support to assist user manufacturing activities, with services including training (at the Center), test cuts, technical consulting, line diagnostics (at the user's site) and tooling proposals.



## Tool Engineering Center Locations

### Japan

- ▶ Itami Tool Engineering Center (I-TEC)
- ▶ Yokohama Tool Engineering Center (Y-TEC)
- ▶ Hokkaido Igetalloy Tool Engineering Center (H-TEC)
- ▶ Tokai Tool Engineering Center (T-TEC)
- ▶ Kyushu Tool Engineering Center (K-TEC)

### Overseas

- ▶ Germany / European Design & Engineering Center (E-DEC)
- ▶ Thailand / Thailand Tool Engineering Center (Ti-TEC)
- ▶ Shanghai / Shanghai Tool Engineering Center (S-TEC)
- ▶ U.S.A. / Americas Tool Engineering Center (A-TEC)
- ▶ Indonesia / Indonesia Tool Engineering Center (In-TEC)
- ▶ India Tool Engineering Center

## 1 Training

To make it easy for anyone to take part, the Centers offer training courses designed for a variety of different training objectives and participants.

\*Contact your nearest SEI sales office for detailed training curricula.

## 2 Performance evaluation technology

To attain improvements in machining on sites, manufacturers must rely on more than just the subjective guidance provided by experience and instinct. Today's advanced measuring instruments can make machining phenomena observable, and clarify problems.

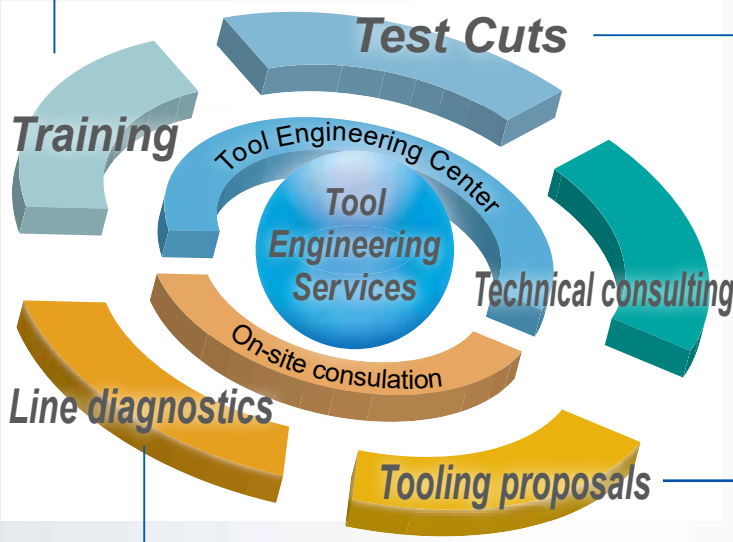

## 3 Test cuts and technical consulting

The Tool Engineering Centers can make test cuts on user workpieces, and work with users to create more detailed technical proposals. The Centers can also provide solutions to various machining problems, general line diagnostics for machining lines, and tooling support for new lines.

\*Contact your nearest SEI sales office for more information.



# SUMITOMO

CARBIDE - CBN - DIAMOND

# SUMITOMO ELECTRIC

## CUTTING TOOLS

# WORLDWIDE LOCATIONS

We are strengthening its global position for high-quality products and services, while contributing technology to market needs around the world.



- Sales Network    ●
- Production Network
- Tool Engineering Center

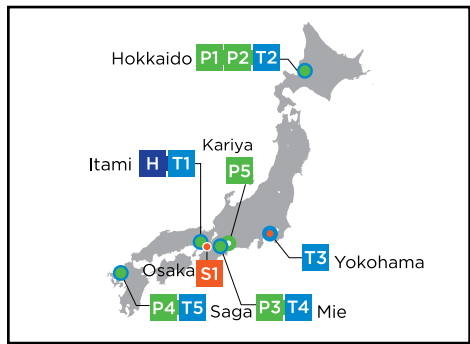

**H** Sumitomo Electric Industries Ltd. Hardmetal Div. Sumitomo Electric Hardmetal Corp.

### Production Network



**P1** Hokkaido Sumiden Precision Co., Ltd.



**P2** Hokkaido Precision Tool Co., Ltd.



**P3** Tokai Sumiden Precision Tool Co., Ltd.



**P4** Kyushu Sumiden Seimitsu Ltd.



**P5** Asdex Corporation



**P6** Sumitomo Electric Hartmetallfabrik GmbH



**P7** Sumitomo Electric Hartmetallfabrik GmbH, organizační složka.



**P8** Sumitomo Electric Hardmetal Manufacturing (Changzhou) Co., Ltd.



**P9** Sumitomo Electric Hardmetal Manufacturing (Thailand), Ltd



**P10** PT. Sumiden Hardmetal Manufacturing Indonesia



**P11** Motherson Techno Tools Ltd.



**P12** Sumitomo Electric Carbide Manufacturing, Inc. (WI)



**P13** Sumitomo Electric Carbide Manufacturing, Inc. (OH)



# HARDMETAL GROUP

## CUTTING TOOLS

# EUROPEAN LOCATIONS



**S2** Sumitomo Electric Hartmetall GmbH



- T1** Itami Tool Engineering Center (I-Tec)
- T2** Hokkaido Tool Engineering Center (H-Tec)
- T3** Yokohama Tool Engineering Center (Y-Tec)
- T4** Tokai Tool Engineering Center (T-Tec)
- T5** Kyushu Tool Engineering Center (K-Tec)

- T6** European Design & Engineering Center (E-DEC)
- T7** Shanghai Tool Engineering Center (S-Tec)
- T8** Thai Tool Engineering Center (Ti-Tec)
- T9** Indonesia Tool Engineering Center (In-Tec)
- T10** Americas Tool Engineering Center (A-Tec)
- T11** India Tool Engineering Center

- Sales Network    ●
- Production Network
- Tool Engineering Center

### Sales Network



**S1** Sumitomo Electric Tool Net, Inc.



**S3** Sumitomo Electric Hardmetal Ltd.



**S4** SumiSemetal Ticaret ve Sanayi Limited Şirketi



**S5** Sumitomo Electric Hardmetal Trading (Shanghai) Co., Ltd.



**S6** Superior Engineering Tool Trading (Shanghai) Co., Ltd.



**S7** Sumitomo Electric Hardmetal Asia Pacific Pte Ltd.



**S8** Sumitomo Electric Hardmetal (Thailand) Ltd.



**S9** PT. Sumitomo Electric Hardmetal Indonesia



**S10** SEI Carbide Australia Pty Ltd.



**S11** Motherson Techno Tools Ltd.



**S12** Sumitomo Electric Carbide, Inc.



**S13** Sumicarbide Canada Inc.



**S14** Sumitomo Electric Hardmetal de Mexico, S.A. de C.V.



**S15** Sumitomo Electric Hardmetal do Brasil Ltda.



**S16** Taiwan Hong-Yu Precision Tool Co., Ltd.



**CARBIDE - CBN - DIAMOND**

(Germany)  
SUMITOMO ELECTRIC Hartmetall GmbH  
Konrad-Zuse-Str. 9, 47877 Willich

Tel. +49 2154 4992-0, FAX +49 2154 4992-161  
Info@SumitomoTool.com  
www.SumitomoTool.com



(UK and Ireland)  
SUMITOMO ELECTRIC Hardmetal Ltd.  
3 Paper Mill Drive  
Redditch, B98 8QJ, UK

Tel. +44 1844 342081, FAX +44 1844 342415  
InfoUK@sumitomoTool.com  
www.SumitomoTool.com



Distributed by :