

Radius Mill for General Purpose and Exotic Alloys

„Wave Radius Mill“ **RSX Series**

Extension of ACM Series: ACP200 and ACK300
Introduction of RSX08000 and RSX20000 Types



Wave Radius Mill RSX Series



■ Features



The Wave Radius Mill RSX Series enables stable machining even when using equipment with low clamp rigidity thanks to its body design achieving excellent cutting performance and rigidity.

In addition to the ACM Series for stainless steel and exotic alloys two grades have been added: ACP200 grade for steel machining and ACK300 grade for cast iron machining. Handle an even wider range of milling needs with the RSX(F)08000 and RSX(F)20000 types.

■ Characteristics

Smooth cutting action and low vibration machining provided based on the high rake angle design and high rigidity body. High reliability achieved with ACM100 / ACM200 / ACM300 adopted for exotic alloy machining. ACP200 for steel and ACK300 for cast iron enable stable machining in a wide range of applications.

■ Series

Image	Series	Insert Size	Cat. No.	External Diameter (mm)													
				ø20	ø25	ø32	ø40	ø50	ø52	ø63	ø66	ø80	ø100	ø125	ø160		
 Shank Type	Standard	08	RSX 08000 ES	●	●												
		10	RSX 10000 ES		●	●											
		12	RSX 12000 ES			●											
	Fine Pitch	08	RSXF 08000 ES		●	●											
		10	RSXF 10000 ES			●	●										
		12	RSXF 12000 ES				●										
 Shell Type	Standard	10	RSX 10000 RS				●	●	●								
		12	RSX 12000 RS				●	●	●	●	●						
		16	RSX 16000 RS							●	●	●	●	●			
		20	RSX 20000 RS								●	●	●	●	●		
	Fine Pitch	10	RSXF 10000 RS				●	●	●								
		12	RSXF 12000 RS				●	●	●	●	●						
		16	RSXF 16000 RS							●	●	●	●	●	●		
		20	RSXF 20000 RS								●	●	●	●	●	□	
 Modular Type	Standard	08	RSX 08000 M	●	●	●											
		10	RSX 10000 M		●	●											
		12	RSX 12000 M			●	●										
	Fine Pitch	08	RSXF 08000 M		●	●											
		10	RSXF 10000 M			●	●										
		12	RSXF 12000 M				●	●									

□ Delivery on request

● Euro stock

■ Cutting Performance

● Tool Life Comparison (Fracture Resistance)

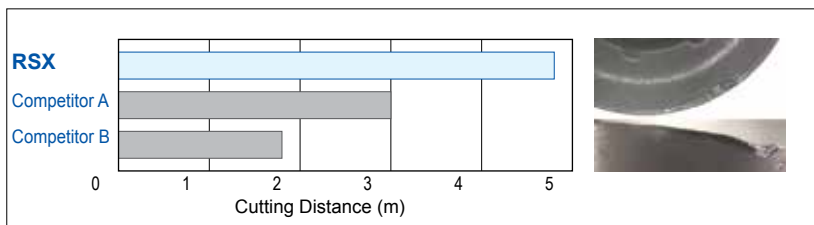

● Cutting Vibration Comparison

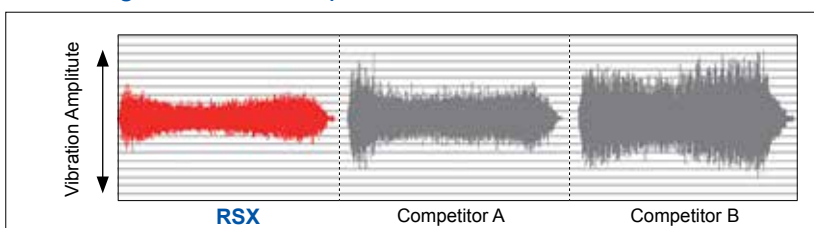

● Cutting Resistance Comparison

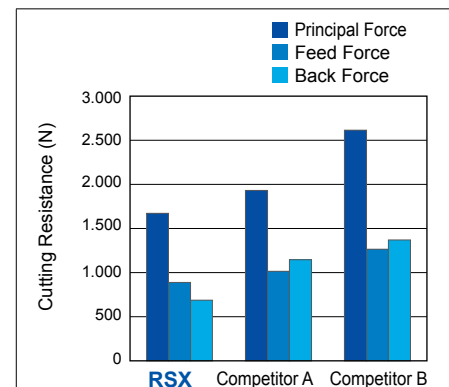

Work Material: X5CrNiS1810
 Tool: Ø50
 Cutting Data: $v_c = 200\text{m/min}$, $f_t = 0,5\text{mm/t}$,
 $a_p = 2,0\text{mm}$, $a_e = 10,0\text{mm}$,
 Wet

Low Cutting Resistance, Less Vibration

Low cutting resistance and low vibration machining have been achieved with super high rake angle design + high rigidity body.

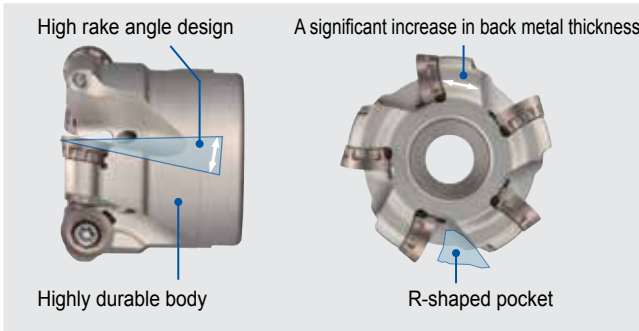

High Operability

Ease of corner control has been achieved with the adoption of a unique positioning mechanism that is highly precise and highly operable.

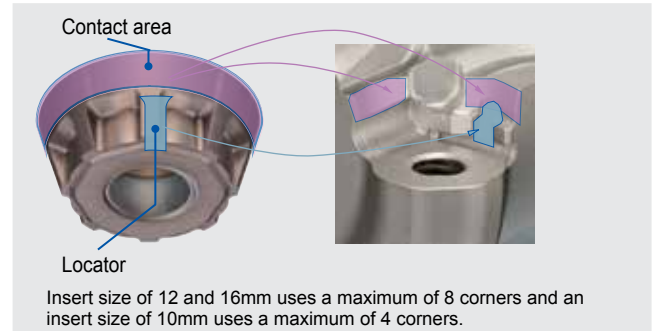

Stable and Long Tool Life

A long life ensured with the adoption of the ACM series and significant improvements have been made in processing exotic alloy and stainless steel machining.

Work Material	Resistance	
	Wear Resistance	Fracture Resistance
P	ACP200	
M	ACM100	ACM200
		ACM300
K	ACK300	
S	ACM100	ACM200
		ACM300

Coating Type: ▽ CVD ▲ PVD

ACP200/ACM100/ACM300/ACK300

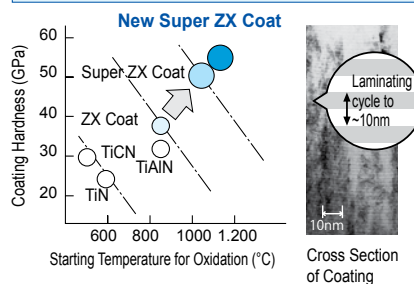

New Super ZX Coat

The product series with a coating film hardness approximately 40% higher and an oxidation onset temperature 200°C higher than conventional products. Enables machining at least 1.5 times faster and more efficiently than conventional products. A product life at least twice as long as that of conventional products achieved under the same machining conditions.

ACM200

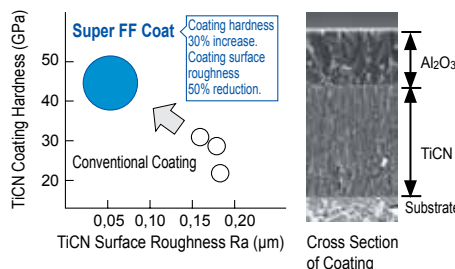

Super FF Coat

Smooth coating surface provides excellent adhesion and chipping resistance. Improved coating adhesion strength. Harder than conventional coatings with high improvements in wear resistance. High speed, high efficiency machining of more than 1.5 times than of conventional grades possible. Achieving more than double the tool life of conventional grades under the same cutting conditions.

Various Machining Use

Various types of processing, such as mould engraving, slant milling and helical processing.

Helical Milling

Helical Milling
 ϕD
Smaller Work Diameter
 ϕD
Center uncut portion cannot be removed by traverse cutting with the same cutter.
Bigger Work Diameter
 ϕD
Center uncut portion can be removed by traverse cutting with the same cutter.

Ramping

Use at α° or lower

Recommended Values for Helical and Ramping

Insert Cat. No.	Cutter ϕD_c	Helical Work Diameter			Taper Ramping Angle α° (max)
		Min.	Optimal ϕ	Max.	
RDET08...	20	27.6	32	39	12°00'
	25	37.0	42	49	7°15'
	32	50.8	56	63	4°45'
RDET10...	25	33.0	40	49	10°30'
	32	46.0	54	63	6°45'
	40	62.0	70	79	4°30'
	50	82.0	90	99	3°15'
	52	86.0	94	103	3°10'
RDET12...	32	41.5	52	63	12°30'
	40	57.5	68	79	8°00'
	50	77.5	88	99	5°30'
	52	81.5	92	103	5°15'
	63	103.5	114	125	4°00'
	66	109.5	120	131	3°45'
	80	137.5	148	159	2°50'
RDET16...	100	177.5	188	199	2°10'
	63	96.0	110	125	6°00'
	80	130.0	144	159	4°10'
	100	170.0	184	199	3°00'
	125	220.0	234	249	2°20'
RDET20...	80	122.0	140	159	4°15'
	100	162.0	180	199	3°00'
	125	212.0	230	249	2°00'
	160	282.0	300	319	1°15'

Wave Radius Mill

RSX(F)_{10000/12000/16000/20000RS}

Milling of steel, stainless steel, cast iron and exotic alloys

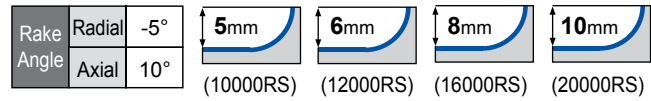

Body – Dimensions

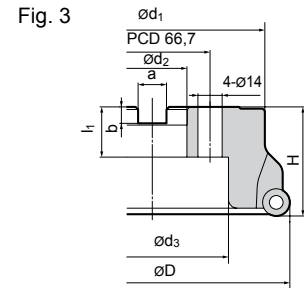
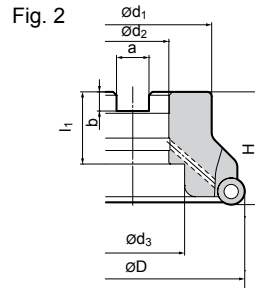
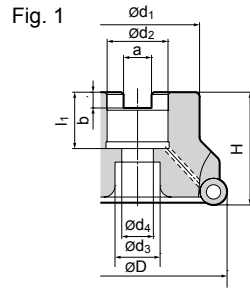

Body (RSX...RS, Standard)

Cat. No.	Stock	Dimensions (mm)									No. of teeth	Weight (kg)	Fig.
		øD	ød ₁	H	ød ₂	a	b	l ₁	ød ₃	ød ₄			
RSX 10040 RS	●	40	34	40	16	8,4	5,6	18	14	9	4	0,2	1
RSX 10050 RS	●	50	40	40	22	10,4	6,3	20	18	11	5	0,3	1
RSX 10052 RS	●	52	40	40	22	10,4	6,3	20	18	11	5	0,4	1
RSX 12040 RS	●	40	32	40	16	8,4	5,6	18	13,5	9	3	0,2	1
RSX 12050 RS	●	50	40	40	22	10,4	6,3	20	18	11	4	0,3	1
RSX 12052 RS	●	52	40	40	22	10,4	6,3	20	18	11	4	0,3	1
RSX 12063 RS	●	63	40	40	22	10,4	6,3	20	18	11	5	0,4	1
RSX 12066 RS	●	66	55	50	27	12,4	7,0	25	20	14	6	0,7	1
RSX 12080 RS	●	80	55	50	27	12,4	7,0	25	20	14	6	1,0	1
RSX 12100 RS	●	100	70	50	32	14,4	8,5	32	46	-	6	1,4	2
RSX 16063 RS	●	63	50	40	22	10,4	6,3	20	18	11	4	0,5	1
RSX 16080 RS	●	80	55	50	27	12,4	7,0	25	20	14	5	0,9	1
RSX 16100 RS	●	100	70	50	32	14,4	8,5	32	46	-	6	1,3	2
RSX 16125 RS	●	125	80	63	40	16,4	9,5	29	52	29	6	2,6	1
RSX 20080 RS	●	80	55	50	27	12,4	7,0	22	20	14	4	0,9	1
RSX 20100 RS	●	100	70	63	32	14,4	8,0	32	46	-	5	1,8	2
RSX 20125 RS	●	125	80	63	40	16,4	9,0	29	52	29	6	2,6	1
RSX 20160 RS	●	160	130	63	40	16,4	9,0	29	90	-	7	4,7	3



Body (RSXF...RS, Fine Pitch)

Cat. No.	Stock	Dimensions (mm)									No. of teeth	Weight (kg)	Fig.
		øD	ød ₁	H	ød ₂	a	b	l ₁	ød ₃	ød ₄			
RSXF 10040 RS	●	40	34	40	16	8,4	5,6	18	14	9	5	0,2	1
RSXF 10050 RS	●	50	40	40	22	10,4	6,3	20	18	11	6	0,3	1
RSXF 10052 RS	●	52	40	40	22	10,4	6,3	20	18	11	6	0,3	1
RSXF 12040 RS	●	40	32	40	16	8,4	5,6	18	13,5	9	4	0,2	1
RSXF 12050 RS	●	50	40	40	22	10,4	6,3	20	18	11	5	0,3	1
RSXF 12052 RS	●	52	40	40	22	10,4	6,3	20	18	11	5	0,3	1
RSXF 12063 RS	●	63	40	40	22	10,4	6,3	20	18	11	6	0,4	1
RSXF 12066 RS	●	66	55	50	27	12,4	7,0	25	20	14	7	0,7	1
RSXF 12080 RS	●	80	55	50	27	12,4	7,0	25	20	14	7	0,9	1
RSXF 12100 RS	●	100	70	50	32	14,4	8,5	32	46	-	10	1,3	2
RSXF 16063 RS	●	63	50	40	22	10,4	6,3	20	18	11	5	0,4	1
RSXF 16080 RS	●	80	55	50	27	12,4	7,0	25	20	14	6	0,8	1
RSXF 16100 RS	●	100	70	50	32	14,4	8,5	32	46	-	7	1,3	2
RSXF 16125 RS	●	125	80	63	40	16,4	9,5	29	52	29	8	2,5	1
RSXF 16160 RS	□	160	130	63	40	16,4	9,5	29	88	-	10	4,8	3
RSXF 20080 RS	●	80	55	50	27	12,4	7,0	22	20	14	5	0,9	1
RSXF 20100 RS	●	100	70	50	32	14,4	8,0	32	46	-	6	1,8	2
RSXF 20125RS	●	125	80	63	40	16,4	9,0	29	52	29	7	2,6	1
RSXF 20160RS	●	160	130	63	40	16,4	9,0	29	90	-	9	4,6	3

□ Delivery on request

● Euro stock

Spare Parts

Applicable Cutters	Wrench	Screw	Tightening Torque (N·m)
			
RSX(F) 10000 RS	TRDR15IP	BFTX03584IP	3,0
RSX(F) 12000 RS		BFTX0409IP	3,0
RSX(F) 16000 RS	TRDR20IP	BFTX0511IP	5,0
RSX(F) 20000 RS	TRDR25IP	BFTX0615IP	5,0

Cutter Identification

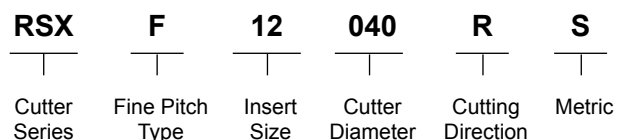

Wave Radius Mill RSX(F)08000/10000/12000ES

Milling of steel, stainless steel, cast iron and exotic alloys

Body – Dimensions

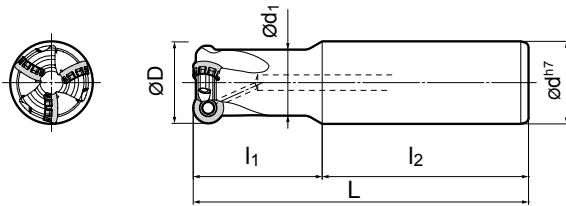

Rake Angle	Radial	-5°
	Axial	10°

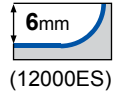
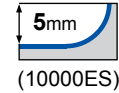
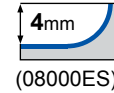

Body (RSX...ES, Standard)

Cat. No.	Stock	Dimensions (mm)							No. of teeth	Weight (kg)
		ØD	Ød	Ød ₁	l ₁	l ₂	L			
RSX 08020 ES	●	20	20	16,9	30	70	100	2	0,3	
08025 ES	●	25	25	21,9	40	80	120	3	0,4	
RSX 10025 ES	●	25	25	20,3	50	80	130	2	0,4	
10032 ES	●	32	32	27,1	50	80	130	3	0,7	
RSX 12032 ES	●	32	32	25,6	50	80	130	2	0,7	

Body (RSXF...ES, Standard)

Cat. No.	Stock	Dimensions (mm)							No. of teeth	Weight (kg)
		ØD	Ød	Ød ₁	l ₁	l ₂	L			
RSXF08020 ES	●	20	20	16,9	30	70	100	3	0,3	
08025 ES	●	25	25	21,9	40	80	120	4	0,4	
RSXF 10025 ES	●	25	25	20,3	50	80	130	3	0,4	
10032 ES	●	32	32	27,1	50	80	130	4	0,7	
RSX 12032 ES	●	32	32	25,6	50	80	130	3	0,7	

● Euro stock

Spare Parts

Applicable Cutters	Wrench	Screw	Tightening Torque (N·m)
	RSX(F) 08000 ES	TRDR08IP	
RSX(F) 10000 ES	TRDR15IP	BFTX03584IP	3,0
RSX(F) 12000 ES		BFTX0409IP	3,0

Cutter Identification

RSX	F	10	025	ES
Cutter Series	Fine Pitch Type	Insert Size	Cutter Diameter	Endmill Type

Inserts

Application	Grade					Dimens.		Applicable Cutters
	ACP200	ACK300	ACM100	ACM200	ACM300	Ød (IC)	S	
High Speed/Light Cut			M S	M S				
General Purpose	F M		M S	M S	M S			
Roughing	P M	K			M S			
Cat. No.	ACP200	ACK300	ACM100	ACM200	ACM300	Ød (IC)	S	Applicable Cutters
RDET 0803M0EN G	●	●	●	●	●	08	3,18	RSX(F) 08000ES
0803M0EN H	●	●	●	●	●	08	3,18	
RDET 10T3M0EN G	●	●	●	●	●	10	3,97	RSX(F) 10000RS RSX(F) 10000ES
10T3M0EN H	●	●	●	●	●	10	3,97	
RDET 1204M0EN G	●	●	●	●	●	12	4,76	RSX(F) 12000RS RSX(F) 12000ES
1204M0EN H	●	●	●	●	●	12	4,76	
RDET 1606M0EN G	●	●	●	●	●	16	6,5	RSX(F) 16000RS
1606M0EN H	●	●	●	●	●	16	6,5	
RDET 2006M0EN G	●	●	●	●	●	20	6,5	RSX(F) 20000RS
2006M0EN H	●	●	●	●	●	20	6,5	

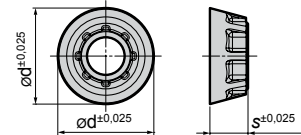

Cutting Edge Cross Section

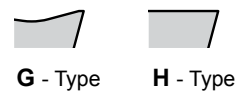

M0: IC is metric

● Euro stock

Recommended Cutting Conditions



Min.-Optimum-Max.

ISO	Work Material		Hardness	Cutting Speed v _c (m/min)	Feed Rate f _t (mm/t)	Grade	
P	Carbon Steel		180-280HB	100- 160 -200	0,20- 0,40 -0,60	ACP200	
	Alloy Steel		180-280HB	100- 140 -180	0,20- 0,30 -0,40	ACP200	
M	Stain- less Steel	Cr Based	Ferritic	200HB	150- 180 -200	0,15- 0,25 -0,35	ACM300
			Martensitic	200-330HB	80- 120 -180	0,15- 0,25 -0,35	ACM300
	Cr-Ni Based	Austenitic	200HB	150- 180 -200	0,15- 0,25 -0,35	ACM300	
		Austenitic, ferritic	230-270HB	80- 120 -180	0,15- 0,25 -0,35	ACM200	
		Precipitation hardening	330HB	60- 100 -160	0,15- 0,25 -0,35	ACM200	
K	Cast Iron		250HB	80- 120 -160	0,10- 0,30 -0,40	ACK300	
S	Heat resistant alloy	Ni based material		250-350HB	20- 30 - 40	0,10- 0,20 -0,30	ACM100 ACM200
	Titanium	Pure Titanium		(Rm400)	60- 80 -100	0,10- 0,20 -0,30	
		α + β alloyed material		(Rm1050)	40- 50 - 60	0,10- 0,20 -0,30	

Wave Radius Mill

RSX(F)08000/10000/12000M

Modular Tools

Rake Angle	Radial	-5°			
	Axial	10°	(08000M)	(10000M)	(12000M)

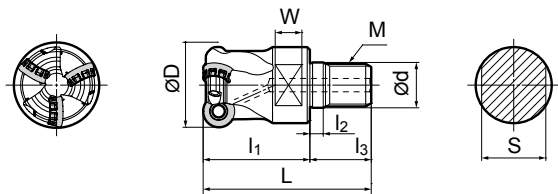

Body (RSX...M, Standard)

Cat. No.	Stock	Dimensions (mm)										No. of Teeth	Weight (kg)
		ØD	Ød	M	L	l ₁	l ₂	l ₃	W	S			
RSX 08020M10Z2	●	20	10,5	M10	49	30	5	19	8	15	2	0,1	
08025M12Z3	●	25	12,5	M12	56	35	5	21	10	19	3	0,1	
08032M16Z4	●	32	17,0	M16	63	40	5	23	10	24	4	0,2	
RSX 10025M12Z2	●	25	12,5	M12	56	35	5	21	10	19	2	0,1	
10032M16Z3	●	32	17,0	M16	63	40	5	23	10	24	3	0,2	
RSX 12032M16Z2	●	32	17,0	M16	63	40	5	23	10	24	2	0,2	
12040M16Z3	●	40	17,0	M16	63	40	5	23	10	24	3	0,3	

Body (RSXF...M, Fine Pitch)

Cat. No.	Stock	Dimensions (mm)										No. of Teeth	Weight (kg)
		ØD	Ød	M	L	l ₁	l ₂	l ₃	W	S			
RSXF 08020M10Z3	●	20	10,5	M10	49	30	5	19	8	15	3	0,1	
08025M12Z4	●	25	12,5	M12	56	35	5	21	10	19	4	0,1	
08032M16Z5	●	32	17,0	M16	63	40	5	23	10	24	5	0,2	
RSXF 10025M12Z3	●	25	12,5	M12	56	35	5	21	10	19	3	0,1	
10032M16Z4	●	32	17,0	M16	63	40	5	23	10	24	4	0,2	
RSXF 12032M16Z3	●	32	17,0	M16	63	40	5	23	10	24	3	0,2	
12040M16Z4	●	40	17,0	M16	63	40	5	23	10	24	4	0,3	

● Euro stock

Inserts

Application	Grade					Dimens.		Applicable Cutters
	ACP200	ACK300	ACM100	ACM200	ACM300	Ød (IC)	S	
High Speed/Light Cut			M S	M S				
General Purpose	P M		M S	M S	M S			
Roughing	P M	K			M S			
Cat. No.	ACP200	ACK300	ACM100	ACM200	ACM300	Ød (IC)	S	
RDET 0803M0EN G	●	●	●	●	●	08	3,18	RSX(F) 08000M
0803M0EN H	●	●	●	●	●	08	3,18	
RDET 10T3M0EN G	●	●	●	●	●	10	3,97	RSX(F) 10000M
10T3M0EN H	●	●	●	●	●	10	3,97	
RDET 1204M0EN G	●	●	●	●	●	12	4,76	RSX(F) 12000M
1204M0EN H	●	●	●	●	●	12	4,76	

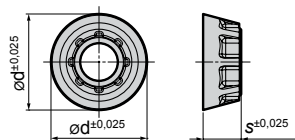

Cutting Edge Cross Section



M0: IC is metric
● Euro stock

Spare Parts

Applicable Cutters	Wrench	Screw	Tightening Torque
RSX(F) 08000M	TRDR08IP	BFTX02506IP	1,5
RSX(F) 10000M		BFTX03584IP	3,0
RSX(F) 12000M	TRDR15IP	BFTX0409IP	3,0

Cutter Identification

RSX	F	10	025	M12	Z3
Cutter Series	Fine Pitch Type	Insert Size	Cutter Diameter	Mounting Screw Size	No. of Teeth

Recommended Cutting Conditions

Min.-Optimum-Max.

ISO	Work Material	Hardness	Cutting Speed v _c (m/min)	Feed Rate f _t (mm/t)	Grade	
P	Carbon Steel	180-280HB	100-160-200	0,20-0,40-0,60	ACP200	
	Alloy Steel	180-280HB	100-140-180	0,20-0,30-0,40	ACP200	
M	Cr Based	Ferritic	200HB	150-180-200	0,15-0,25-0,35	ACM300
		Martensitic	200-330HB	80-120-180	0,15-0,25-0,35	ACM300
	Cr-Ni Based	Austenitic	200HB	150-180-200	0,15-0,25-0,35	ACM300
		Austenitic, ferritic	230-270HB	80-120-180	0,15-0,25-0,35	ACM200
S	Cast Iron	Precipitation hardening	330HB	60-100-160	0,15-0,25-0,35	ACM200
		Heat resistant alloy	250HB	80-120-160	0,10-0,30-0,40	ACK300
	Titanium	Ni based material	250-350HB	20-30-40	0,10-0,20-0,30	ACM100
		Pure Titanium	(Rm400)	60-80-100	0,10-0,20-0,30	ACM200
		α + β alloyed material	(Rm1050)	40-50-60	0,10-0,20-0,30	

Special Arbors for Modular Tools

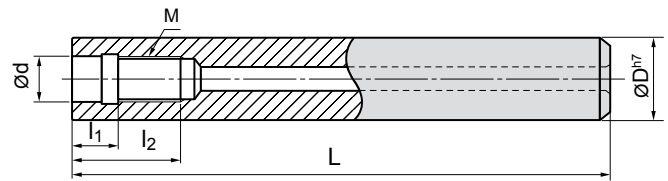

Carbide Arbor

Cat. No.	Stock	Dimensions (mm)						
		M	ød	øD	L	l ₁	l ₂	L _M
MA 23 M12 L200C	●	M12	12,5	23	200	10	22	235
MA 23 M12 L250C	●	M12	12,5	23	250	10	22	285
MA 25 M12 L200C	●	M12	12,5	25	200	10	22	235
MA 25 M12 L250C	●	M12	12,5	25	250	10	22	285
MA 28 M16 L200C	●	M16	17,0	28	200	10	24	240
MA 28 M16 L300C	●	M16	17,0	28	300	10	24	340
MA 32 M16 L200C	●	M16	17,0	32	200	10	24	240
MA 32 M16 L300C	●	M16	17,0	32	300	10	24	340

Steel Arbor

Cat. No.	Stock	Dimensions (mm)						
		M	ød	øD	L	l ₁	l ₂	L _M
MA 25 M12 L200S	●	M12	12,5	25	200	10	22	235
MA 32 M16 L200S	●	M16	17,0	32	200	10	24	240

● Euro stock

Modular Tool System



Arbor Identification

MA	23	M12	L200	C
Modular Arbor	Shank Diameter	Mounting Screw Size	Arbor Length	Material: C: Carbide S: Steel

Recommended Tightening Torque



Screw Size	Tightening Torque (N·m)	Tool Dimensions	
		W	S
M12	80	10	19
M16	90	10	24

Notes about tightening the head:

When attaching the cutter head to an arbor, follow the recommended tightening torque (table left). Confirm the mounting screw size for the head and the arbor before assembly.

Wave Radius Mill RSX Series

Application Example

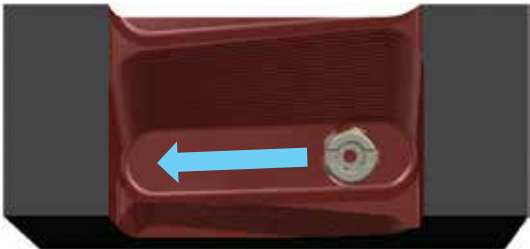
Generator parts / X12CrNi25-21		Detail	RSX Type	Competitor
	Tool	Body	RSXF12050RS	Cutter ø50
		Insert	RDET1204M0EN G	ø12
		Diameter (mm)	ø50	ø50
		No. of Teeth	5	5
		Grade	ACM300 (PVD)	(CVD)
Cutting Conditions	Cutting Speed (m/min)	300	300	
	Feed (mm/t)	0,35	0,35	
	Axial Cutting Depth (mm)	2,0	2,0	
	Cutting Width (mm)	50,0	50,0	
	Coolant	Air Blow	Air Blow	
Results	Ensuring a life approximately 1,2 times longer than competitor's.			

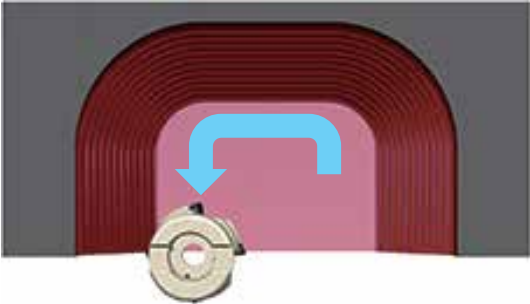
Generator parts / Inconel 718		Detail	RSX Type	Competitor
	Tool	Body	RSX12050RS	Cutter ø50
		Insert	RDET1204M0EN G	ø12
		Diameter (mm)	ø50	ø50
		No. of Teeth	4	5
		Grade	ACM200 (CVD)	(CVD)
Cutting Conditions	Cutting Speed (m/min)	32	21	
	Feed (mm/t)	0,28	0,11	
	Axial Cutting Depth (mm)	1,5	1,5	
	Cutting Width (mm)	50,0	50,0	
	Coolant	Dry	Dry	
Results	Ensuring a life approximately 2 times longer than competitor's.			



(Germany)
SUMITOMO ELECTRIC Hartmetall GmbH
Konrad-Zuse-Straße 9, 47877 Willich

Tel. +49(0)2154 4992-0, Fax +49(0)2154 4992-161
Info@SumitomoTool.com
www.SumitomoTool.com



(UK and Ireland)
SUMITOMO ELECTRIC Hardmetal Ltd.
Summerleys Road, Princes Risborough
Buckinghamshire HP27 9PW, UK

Tel. +44(0)1844 342081, Fax: +44(0)1844 342415
enquiries@sumitomo-hardmetal.co.uk
www.SumitomoTool.com



Distributed by: