

Z<sup>2</sup>



ORIGIN



DUPLEX



REVOLUTION



# Gear cutting solutions



E<sub>2</sub>F

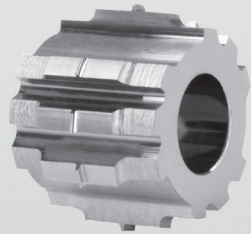

TRINITY

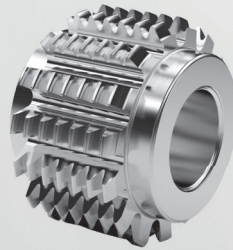



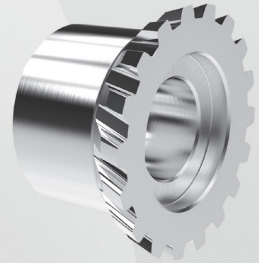







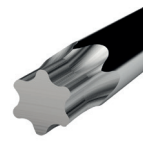

8100

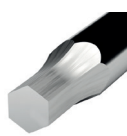

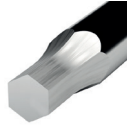









8700

# Gear cutting solutions

Type	Name of tool	Standard modules*	Tool	Machined part	Page
Tooth by tooth gear cutter	Z <sup>2</sup>	m 0.03 - 1.00			5
Hobs for epicyclic & involute teeth	ORIGIN	m 0.015 - 1.000			6
		m 0.015 - 0.800			7
		m 0.015 - 1.000			8
		m 0.015 - 0.800			9
Two-way hob cutter	ORIGIN DUPLEX				
Hobs for asymmetrical gears and special profiles	REVOLUTION	by profile		 	10

\*Depends on the gearing norm  
Other modules upon request

# Gear cutting solutions

Type	Name of tool	Standard modules*	Tool	Machined part	Page
Hobs for frontal gear cutting	<b>E<sub>2</sub>F</b>	m 0.05 - 0.50			11
Hobs for conical gears	<b>TRINITY</b>	m 0.05 - 0.30			12
Hob cutters for involute gears ISO53 / DIN867 DIN quality AAAA	<b>8100</b>	m 0.05 - 1.00			13
<b>NEW</b> Skiving cutter for internal and external gear teeth	<b>8700</b>	m 0.05 - 1.00			14
		m 0.05 - 1.00			

\*Depends on the gearing norm  
Other modules upon request

**New**

# DUPLEX ORIGIN Hobs for epicyclic & involute teeth

Hobbing with two hob cutters is known to produce burr-free hobbing. It is a functional process, but requires sometimes a tedious set-up. It is necessary to make an adjustment for each hob, and the stacking of the arbor, tools and spacers results in a run out and warping.

Louis Bélet SA has found a simple solution that can be used by everyone to solve these problems: ORIGIN DUPLEX hobs.



ORIGIN DUPLEX on a shank

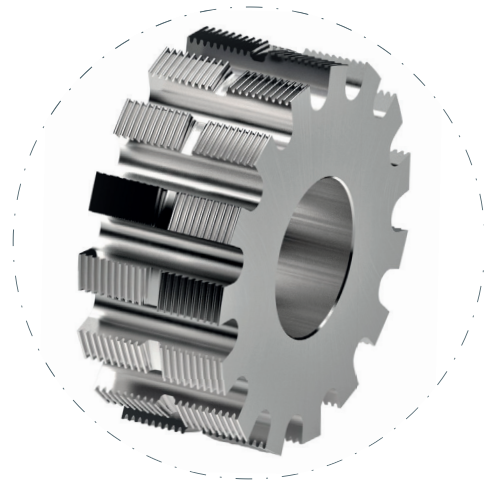

Circular ORIGIN DUPLEX

Made of one-piece solid carbide, these cutters have two cutting areas, one on the right and one on the left. Both profiles are spaced a multiple of the pitch.

This simplifies the machine setup. In addition, run out and axial warpage are greatly reduced.

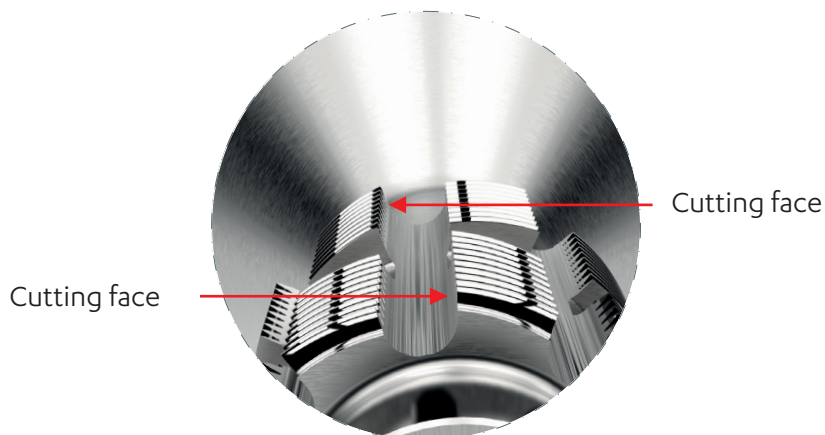

# Tooth by tooth gear cutter

Material	Vc uncoated	Vc coated	Uncoated	Coated	Rec. Coating
Steel 20AP	70	90	■	■	TRIO (PO)
Steel Law 100X	70	90	■	■	TRIO (PO)
Carbon steel (Finemac)	50	60	■	■	TRIO (PO)
4C27A	60	70	■	■	TRIO (PO)
CK45	80	90	■	■	TRIO (PO)
316L	60	70	■	■	TRIO (PO)
Other stainless steel	60	70	■	■	TRIO (PO)
Leaded brass	150	170	■	-	SOLO (DA)
Lead-free brass	150	170	■	■	SOLO (DA)
CuBe (copper alloys)	100	120	■	■	SOLO (DA)
Nickel silver (Maillechort)	120	140	■	■	SOLO (DA)
Bronze	120	140	■	■	SOLO (DA)
Aluminium	200	220	■	■	SOLO (DA)
Titanium	80	90	■	-	-

not adapted - adapted □ highly adapted ■

Tolerances D : h5

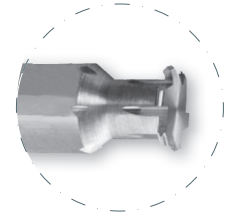
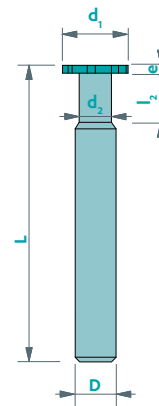

Standard modules: 0.020 - 1.000. Other modules upon request

d <sub>1</sub>	e	d <sub>2</sub>	l <sub>1</sub>	D	L	Z
<2	0.3 - 1.0	1.0	1	3	38	2 - 3
2	0.3 - 1.0	1.0	1	3	38	2 - 3
3	0.3 - 1.0	2.0	2	3	38	3
4	0.3 - 1.5	2.5	2	4	38	5
5	0.3 - 1.5	3.5	2	5	38	6
6	0.3 - 1.5	3.5	2	6	38	6
7	0.3 - 1.5	3.5	2	7	38	6
8	0.5 - 2.0	4.0	3	8	51	6
10	0.5 - 3.0	5.0	4	10	51	6
12	0.5 - 3.0	6.0	4	12	61	8
15	2.0 - 5.0	8.0	4	10	61	8
20	2.0 - 5.0	8.0	4	10	61	12
25	2.0 - 5.0	8.0	4	10	61	12

Option : circular saw

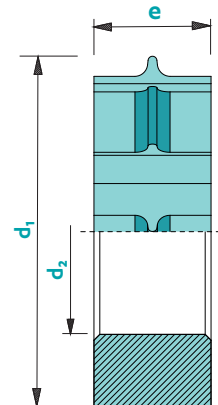

Available uncoated or coated

Z 2-12

Topping

CARB

m ≥ 0.020

Option : No topping

## Hobs for epicyclic & involute teeth

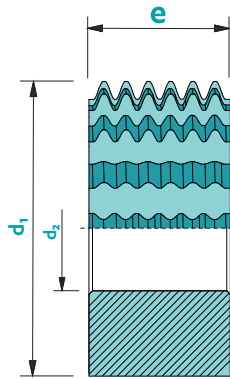
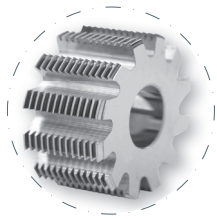

Material	Vc uncoated	Vc coated	Uncoated	Coated	Rec. Coating
Steel 20AP	70	90	■	□	TRIO (PO)
Steel Law 100X	70	90	■	□	TRIO (PO)
Carbon steel (Finemac)	50	60	■	■	TRIO (PO)
4C27A	60	70	■	■	TRIO (PO)
CK45	80	90	■	■	TRIO (PO)
316L	60	70	■	■	TRIO (PO)
Other stainless steel	60	70	■	■	TRIO (PO)
Leaded brass	150	170	■	-	SOLO (DA)
Lead-free brass	150	170	■	□	SOLO (DA)
CuBe (copper alloys)	100	120	■	□	SOLO (DA)
Nickel silver (Maillechort)	120	140	■	□	SOLO (DA)
Bronze	120	140	■	□	SOLO (DA)
Aluminium	200	220	■	-	SOLO (DA)
Titanium	80	90	■	-	-

not adapted - adapted □ highly adapted ■

Tolerances  $d_2$ : H3  $e$ : ±0.01

Standard modules: 0.015 - 1.000. Other modules upon request

Available uncoated or coated

**Z**  
12-15

Topping

$\lambda$   
0°

$\gamma$   
0°

**CARB**

$m \geq$   
**0.015**

$d_1$	$e$	$d_2$	Z	$d_1$	$e$	$d_2$	Z
6	4	3.5	12	12	6	6.0	15
6	5	3.5	12	12	8	6.0	15
6	6	3.5	12	16	4	8.0	15
8	4	3.5	12/15	16	6	8.0	15
8	5	3.5	12/15	16	8	8.0	15
8	6	3.5	12/15	16	10	8.0	15
8	6	4.5	12/15	16	12	8.0	15
8	8	4.5	12/15	18	6	6.0	15
10	4	3.5	12/15	18	6	8.0	15
10	4	4.0	12/15	18	8	8.0	15
10	4	4.5	12/15	18	10	8.0	15
10	5	3.5	12/15	18	12	8.0	15
10	6	3.5	12/15	24	4	8.0	15
10	5	4.5	12/15	24	5	8.0	15
10	6	4.5	12/15	24	6	8.0	15
12	6	3.5	15	24	8	8.0	15
12	5	4.5	15	24	10	8.0	15
12	6	4.5	15	24	12	8.0	15
12	8	4.5	15	24	15	8.0	15
12	10	4.5	15	32	15	13.0	15
12	6	5.0	15				
12	8	5.0	15				

Option : No topping

## Gear cutting hob on a shank

Material	Vc uncoated	Vc coated	Uncoated	Coated	Rec. Coating
Steel 20AP	70	90	■	□	TRIO (PO)
Steel Law 100X	70	90	■	□	TRIO (PO)
Carbon steel (Finemac)	50	60	■	■	TRIO (PO)
4C27A	60	70	■	■	TRIO (PO)
CK45	80	90	■	■	TRIO (PO)
316L	60	70	■	■	TRIO (PO)
Other stainless steel	60	70	■	■	TRIO (PO)
Leaded brass	150	170	■	-	SOLO (DA)
Lead-free brass	150	170	■	□	SOLO (DA)
CuBe (copper alloys)	100	120	■	□	SOLO (DA)
Nickel silver (Maillechort)	120	140	■	□	SOLO (DA)
Bronze	120	140	■	□	SOLO (DA)
Aluminium	200	220	■	-	SOLO (DA)
Titanium	80	90	■	-	-

not adapted - adapted □ highly adapted ■

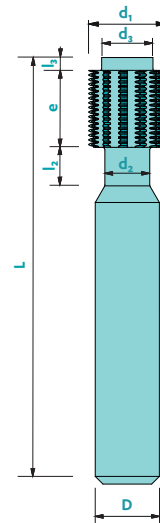

Tolerances D : H5

Standard modules: 0.015 - 0.800. Other modules upon request

$d_1$	e	$d_2$	$l_2$	D	L	Z	$d_3$	$l_3$
3.0	4	2.0	2	6	45	8	2.0	1
3.5	4	2.5	2	6	45	8	2.5	1
4.0	5	3.0	3	6	45	8	3.0	1
5.0	6	3.5	3	6	45	10	3.5	1
6.0	6	4.0	3	6	45	12	4.0	1
8.0	6	-	-	6	45	12	5.0	1
10.0	8	-	-	6	45	15	6.0	1
12.0	8	-	-	6	45	15	8.0	1
16.0	8	-	-	10	51	15	10.0	2
20.0	8	-	-	10	51	15	12.0	2

Available uncoated or coated



Z  
8-15



Topping

$\lambda$   
0°

$\gamma$   
0°

CARB

m ≥  
0.015

Option : No topping

## Duplex hob cutter

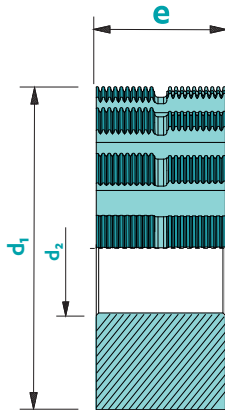
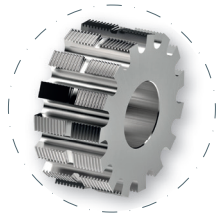

Material	Vc uncoated	Vc coated	Uncoated	Coated	Rec. Coating
Steel 20AP	70	90	■	□	TRIO (PO)
Steel Law 100X	70	90	■	□	TRIO (PO)
Carbon steel (Finemac)	50	60	■	■	TRIO (PO)
4C27A	60	70	■	■	TRIO (PO)
CK45	80	90	■	■	TRIO (PO)
316L	60	70	■	■	TRIO (PO)
Other stainless steel	60	70	■	■	TRIO (PO)
Leaded brass	150	170	■	-	SOLO (DA)
Lead-free brass	150	170	■	□	SOLO (DA)
CuBe (copper alloys)	100	120	■	□	SOLO (DA)
Nickel silver (Maillechort)	120	140	■	□	SOLO (DA)
Bronze	120	140	■	□	SOLO (DA)
Aluminium	200	220	■	-	SOLO (DA)
Titanium	80	90	■	-	-

not adapted - adapted ■ highly adapted ■

Tolerances  $d_2$ : H3  $e$ : ±0.01

Standard modules: 0.015 - 1.000. Other modules upon request

Available uncoated or coated

**Z**  
12-15

Topping

$\lambda$   
0°

$\gamma$   
0°

**CARB**

$m \geq$   
**0.015**

$d_1$	e	$d_2$	Z
6	5	3.5	12
6	6	3.5	12
8	5	3.5	12 / 15
8	6	3.5	12 / 15
8	6	4.5	12 / 15
8	8	4.5	12 / 15
10	5	3.5	12 / 15
10	6	3.5	12 / 15
10	5	4.5	12 / 15
10	6	4.5	12 / 15
12	6	3.5	15
12	5	4.5	15
12	6	4.5	15
12	8	4.5	15
12	10	4.5	15
12	6	5.0	15
12	8	5.0	15
12	6	6.0	15

$d_1$	e	$d_2$	Z
12	8	6.0	15
16	6	8.0	15
16	8	8.0	15
16	10	8.0	15
16	12	8.0	15
18	6	6.0	15
18	6	8.0	15
18	8	8.0	15
18	10	8.0	15
18	12	8.0	15
24	5	8.0	15
24	6	8.0	15
24	8	8.0	15
24	10	8.0	15
24	12	8.0	15
24	15	8.0	15
32	15	13.0	15

Option : No topping



## Duplex hob cutter on a shank

Material	Vc uncoated	Vc coated	Uncoated	Coated	Rec. Coating
Steel 20AP	70	90	■	□	TRIO (PO)
Steel Law 100X	70	90	■	□	TRIO (PO)
Carbon steel (Finemac)	50	60	■	■	TRIO (PO)
4C27A	60	70	■	■	TRIO (PO)
CK45	80	90	■	■	TRIO (PO)
316L	60	70	■	■	TRIO (PO)
Other stainless steel	60	70	■	■	TRIO (PO)
Leaded brass	150	170	■	-	SOLO (DA)
Lead-free brass	150	170	■	□	SOLO (DA)
CuBe (copper alloys)	100	120	■	□	SOLO (DA)
Nickel silver (Maillechort)	120	140	■	□	SOLO (DA)
Bronze	120	140	■	□	SOLO (DA)
Aluminium	200	220	■	-	SOLO (DA)
Titanium	80	90	■	-	-

not adapted - adapted □ highly adapted ■

Tolerances D : H5

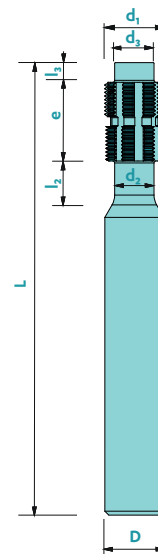

Standard modules: 0.015 - 0.800. Other modules upon request

$d_1$	e	$d_2$	$l_2$	D	L	Z	$d_3$	$l_3$
3.0	5	2.0	2	6	45	8	2.0	1
3.5	5	2.5	2	6	45	8	2.5	1
4.0	5	3.0	3	6	45	8	3.0	1
5.0	6	3.5	3	6	45	10	3.5	1
6.0	6	4.0	3	6	45	12	4.0	1
8.0	6	-	-	6	45	12	5.0	1
10.0	8	-	-	6	45	15	6.0	1
12.0	8	-	-	6	45	15	8.0	1
16.0	8	-	-	10	51	15	10.0	2
20.0	8	-	-	10	51	15	12.0	2

Available uncoated or coated



Z  
8-15



Topping

$\lambda$   
0°

$\gamma$   
0°

CARB



m ≥  
0.015

Option : No topping

## Hobs for asymmetrical gears

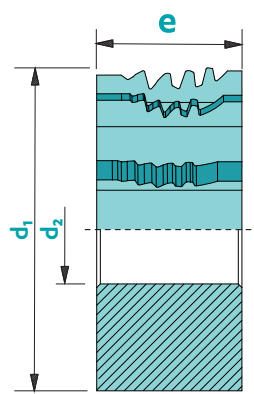

Material	Vc uncoated	Vc coated	Uncoated	Coated	Rec. Coating
Steel 20AP	70	90	■	□	TRIO (PO)
Steel Law 100X	70	90	■	□	TRIO (PO)
Carbon steel (Finemac)	50	60	■	■	TRIO (PO)
4C27A	60	70	■	■	TRIO (PO)
CK45	80	90	■	■	TRIO (PO)
316L	60	70	■	■	TRIO (PO)
Other stainless steel	60	70	■	■	TRIO (PO)
Leaded brass	150	170	■	-	SOLO (DA)
Lead-free brass	150	170	■	□	SOLO (DA)
CuBe (copper alloys)	100	120	■	□	SOLO (DA)
Nickel silver (Maillechort)	120	140	■	□	SOLO (DA)
Bronze	120	140	■	□	SOLO (DA)
Aluminium	200	220	■	-	SOLO (DA)
Titanium	80	90	■	-	-

not adapted - adapted □ highly adapted ■

Tolerances  $d_1$ : H3  $e$ : ±0.01

Standard modules: by profile

$d_1$	$e$	$d_2$
6	4	3.5
6	5	3.5
6	6	3.5
8	4	3.5
8	5	3.5
8	6	3.5
10	4	3.5
10	5	3.5
10	6	3.5
10	5	4.5
10	6	4.5
12	6	4.5
12	8	4.5
12	6	5.0
12	8	5.0
12	6	6.0
12	8	6.0
16	6	8.0
16	8	8.0
16	10	8.0
18	6	6.0
18	6	8.0
18	8	8.0
24	6	8.0
24	8	8.0

Available uncoated or coated

Topping

$\lambda$   
0°

$\gamma$   
0°

**CARB**

Z: by profile  
Option : No topping

# Hobs for frontal gear cutting

Material	Vc uncoated	Vc coated	Uncoated	Coated	Rec. Coating
Steel 20AP	70	90	■	□	TRIO (PO)
Steel Law 100X	70	90	■	□	TRIO (PO)
Carbon steel (Finemac)	50	60	■	■	TRIO (PO)
4C27A	60	70	■	■	TRIO (PO)
CK45	80	90	■	■	TRIO (PO)
316L	60	70	■	■	TRIO (PO)
Other stainless steel	60	70	■	■	TRIO (PO)
Leaded brass	150	170	■	-	SOLO (DA)
Lead-free brass	150	170	■	□	SOLO (DA)
CuBe (copper alloys)	100	120	■	□	SOLO (DA)
Nickel silver (Maillechort)	120	140	■	□	SOLO (DA)
Bronze	120	140	■	□	SOLO (DA)
Aluminium	200	220	■	-	SOLO (DA)
Titanium	80	90	■	-	-

not adapted - adapted □ highly adapted ■

Tolerances  $d_1$ : H3  $e$ : ±0.01

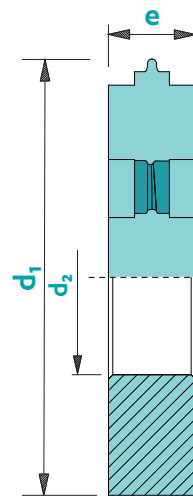

Standard modules: 0.015 - 0.500. Other modules upon request

$d_1$	$e$	$d_2$	Z
6	2	3.5	2-5
8	2	3.5	2-5
10	2	3.5	2-5
10	2	4.5	2-5
12	2	4.5	2-5
12	2	5.0	2-5
12	2	6.0	2-5
16	2	8.0	2-5
18	2	6.0	2-5
18	2	8.0	2-5
24	2	8.0	2-5

Available uncoated or coated



Z2-5



Topping

$\lambda$   
0°

$\gamma$   
0°

CARB

$m \geq$   
0.015

Option : No topping

## Hobs for conical gears

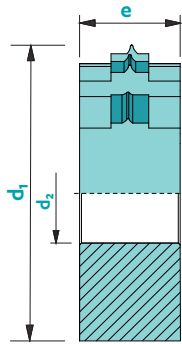
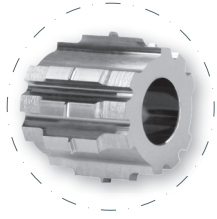



Material	Vc uncoated	Vc coated	Uncoated	Coated	Rec. Coating
Steel 20AP	70	90	■	□	TRIO (PO)
Steel Law 100X	70	90	■	□	TRIO (PO)
Carbon steel (Finemac)	50	60	■	■	TRIO (PO)
4C27A	60	70	■	■	TRIO (PO)
CK45	80	90	■	■	TRIO (PO)
316L	60	70	■	■	TRIO (PO)
Other stainless steel	60	70	■	■	TRIO (PO)
Leaded brass	150	170	■	-	SOLO (DA)
Lead-free brass	150	170	■	□	SOLO (DA)
CuBe (copper alloys)	100	120	■	□	SOLO (DA)
Nickel silver (Maillechort)	120	140	■	□	SOLO (DA)
Bronze	120	140	■	□	SOLO (DA)
Aluminium	200	220	■	-	SOLO (DA)
Titanium	80	90	■	-	-

not adapted - adapted □ highly adapted ■

Tolerances  $d_2$ : H3  $e$ : ±0.01

Standard modules: 0.015 - 0.500. Other modules upon request

Available uncoated or coated

  
 Topping  
 $\lambda$  0°      $\gamma$  0°  
**CARB**  
 $m \geq 0.015$

Z: by profile

Option : No topping

$d_1$	$e$	$d_2$
6	4	3.5
6	5	3.5
6	6	3.5
8	4	3.5
8	5	3.5
8	6	3.5
10	4	3.5
10	5	3.5
10	6	3.5
10	5	4.5
10	6	4.5
12	6	4.5
12	8	4.5
12	6	5.0
12	8	5.0
12	6	6.0
12	8	6.0
16	6	8.0
16	8	8.0
16	10	8.0
18	6	6.0
18	6	8.0
18	8	8.0
24	6	8.0
24	8	8.0

# Hob cutter for involute gears ISO53 / DIN867 - DIN quality AAAA

8100

Material	Vc uncoated	Vc coated	Uncoated	Coated	Rec. Coating
Steel 20AP	70	90	■	□	TRIO (PO)
Steel Law 100X	70	90	■	□	TRIO (PO)
Carbon steel (Finemac)	50	60	■	■	TRIO (PO)
4C27A	60	70	■	■	TRIO (PO)
CK45	80	90	■	■	TRIO (PO)
316L	60	70	■	■	TRIO (PO)
Other stainless steel	60	70	■	■	TRIO (PO)
Leaded brass	150	170	■	-	SOLO (DA)
Lead-free brass	150	170	■	□	SOLO (DA)
CuBe (copper alloys)	100	120	■	□	SOLO (DA)
Nickel silver (Maillechort)	120	140	■	□	SOLO (DA)
Bronze	120	140	■	□	SOLO (DA)
Aluminium	200	220	■	-	SOLO (DA)
Titanium	80	90	■	-	-

not adapted - adapted □ highly adapted ■

Tolerances  $d_1$ : H3 e: ±0.01

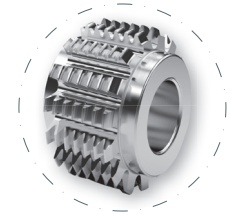
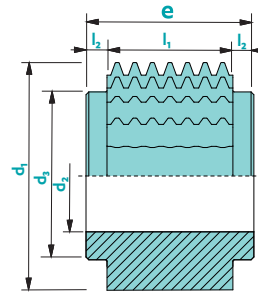

Standard modules: 0.050 to 1.000 every 0.05. Other modules: upon request

Art. n°	$d_1$	e	$l_1$	$d_2$	$d_3$	$l_2$	Z
8100d8e8m###	8	8.0	6	3.5	5.0	1.0	15
8100d8e10m###	8	10.0	8	3.5	5.0	1.0	15
8100d8e12m###	8	12.0	10	3.5	5.0	1.0	15
8100d10e8m###	10	8.0	6	3.5	6.0	1.0	15
8100d10e10m###	10	10.0	8	3.5	6.0	1.0	15
8100d10e12m###	10	12.0	10	3.5	6.0	1.0	15
8100d12e8m###	12	8.0	6	4.5	8.0	1.0	15
8100d12e10m###	12	10.0	8	4.5	8.0	1.0	15
8100d12e12m###	12	12.0	10	4.5	8.0	1.0	15
8100d16e8m###	16	8.0	6	8.0	10.0	1.0	15
8100d16e10m###	16	10.0	8	8.0	10.0	1.0	15
8100d16e12m###	16	12.0	10	8.0	10.0	1.0	15
8100d18e8m###	18	8.0	6	8.0	12.0	1.0	15
8100d18e10m###	18	10.0	8	8.0	12.0	1.0	15
8100d18e12m###	18	12.0	10	8.0	12.0	1.0	15
8100d24e12m###	24	12.0	9	8.0	16.0	1.5	15
8100d24e15m###	24	15.0	12	8.0	16.0	1.5	15
8100d24e20m###	24	20.0	17	8.0	16.0	1.5	15
8100d32e12m###	32	12.0	9	13.0	24.0	1.5	15
8100d32e15m###	32	15.0	12	13.0	24.0	1.5	15
8100d32e20m###	32	20.0	17	13.0	24.0	1.5	15
8100d32e25m###	32	25.0	22	13.0	24.0	1.5	15
8100d32e30m###	32	30.0	27	13.0	24.0	1.5	15

Option : on a shank

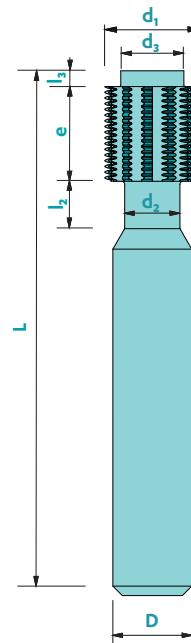

Available uncoated or coated

Z15



$\lambda$   
0°

$\gamma$   
0°

CARB

$m \geq 0.050$

Option : No topping

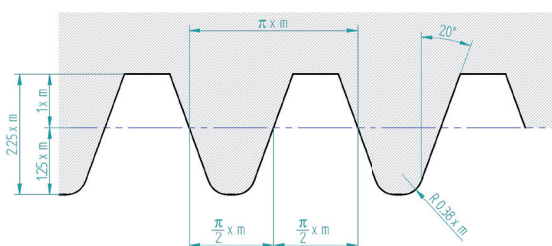

8700

# Skiving cutter for internal and external gears

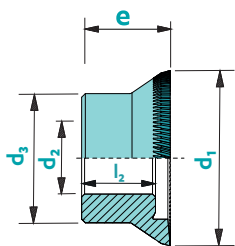

Material	Vc uncoated	Vc coated	Uncoated	Coated	Rec. Coating
Steel 20AP	70	90	■	□	TRIO (PO)
Steel Law 100X	70	90	■	□	TRIO (PO)
Carbon steel (Finemac)	50	60	■	■	TRIO (PO)
4C27A	60	70	■	■	TRIO (PO)
CK45	80	90	■	■	TRIO (PO)
316L	60	70	■	■	TRIO (PO)
Other stainless steel	60	70	■	■	TRIO (PO)
Leaded brass	150	170	■	-	SOLO (DA)
Lead-free brass	150	170	■	□	SOLO (DA)
CuBe (copper alloys)	100	120	■	□	SOLO (DA)
Nickel silver (Maillechort)	120	140	■	□	SOLO (DA)
Bronze	120	140	■	□	SOLO (DA)
Aluminium	200	220	■	-	SOLO (DA)
Titanium	80	90	■	-	-

not adapted - adapted □ highly adapted ■

Tolerances  $d_2$ : H3  $e$ :  $\pm 0.01$

## Circular

Standard modules: 0.050 - 1.000. Other modules upon request

$d_1$	$e$	$d_2$	$d_3$	$l_2$
20-25	12	10	18	10
25-32	12	10	18	10

Other dimensions available upon request.

Z: according to machined part

## On a shank

Standard modules: 0.050 - 1.000. Other modules upon request

$d_1$	$e$	D	L
2-4	0.5-1.0	4	38
3-6	1.0-2.0	6	51
6-8	2.0-3.0	8	61
8-12	3.0	10	61
12-20	3.0-4.0	10	61

Other dimensions available upon request.

$d_2$  et  $l_2$ : according to machined part

Available uncoated or coated



CARB

$m \geq 0.050$

Option : No topping

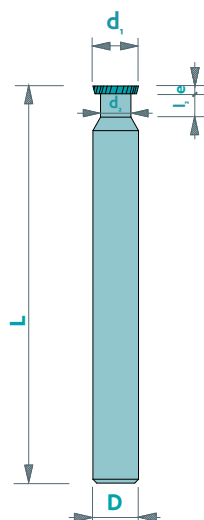

# Web applications

## On-line form

You may send a quote request for hob cutters via our on-line form. Our technical office will analyse your requirements and recommend the suitable hob solution for your application.

## Online Spreadsheet for gear hobbing

Calculate your cutting and machining parameters using our interactive tool:



## Toolfinder

SIMPLIFY YOUR LIFE!

As its name suggests, this new app will help you find the optimal tool for your machining. Once you have chosen the operation to be performed, the material to be machined, the machine available or the dimensions of your machining, you will get a list of tools with different scores allowing you to choose the best cutter for your machining.

BUT THAT'S NOT ALL!

All the know-how of Louis Bélet is hidden behind the configuration page... Indeed, this application will allow you to obtain the machining parameters that our advisors would give you as a first indication!

TO TRY IT IS TO ADOPT IT!

Go to Toolfinder or download this free Toolfinder on your smartphone for a new experience!

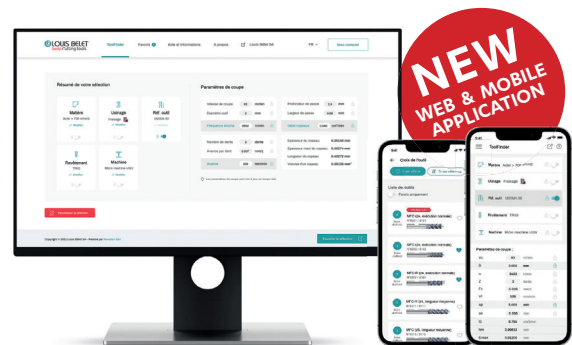



## Louis Bélet SA

Les Gasses 11  
CH- 2943 Vendlincourt  
Tel. +41 (0) 32 474 04 10  
Fax +41 (0) 32 474 45 42

[info@louisbelet.ch](mailto:info@louisbelet.ch)  
[www.louisbelet.ch](http://www.louisbelet.ch)

**List of authorized distributors  
available on [www.louisbelet.ch](http://www.louisbelet.ch)**



 **LOUIS BELET**<sup>®</sup>  
Swiss cutting tools