

Sumi Dual Mill **DMSL / DMSW** Series

High-Productivity High-Feed Cutter for Rough Milling



6-cornered Inserts
Double-sided Inserts

4-cornered Inserts
Double-sided Inserts



General Features

High productivity thanks to an ultra-high metal removal rate as well as high economic efficiency, due to the stable double sided insert with 4 (LNMU) or 6 (WNMU) cutting edges.

The arc-shaped cutting edge reduces the cutting force to a minimum.

High-efficiency machining at maximum feed rate per tooth of 3,5 mm/t is possible.

DMSL type with smaller diameter range is launched now.

Product Range

Type	Cat. No.	Diameter (mm) / No of teeth																				
		Ø16	Ø18	Ø20	Ø22	Ø25	Ø26	Ø28	Ø30	Ø32	Ø35	Ø40	Ø42	Ø50	Ø52	Ø63	Ø66	Ø80	Ø85	Ø100	Ø125	Ø160
Shell	DMSL 06000RS										5 6			5 8	8	8	8	9				
	DMSL 06000R													5 8		8						
	DMSW 08000RS													4 5	4 5	4 5*	5 6	6 8	6 8	6	8	10
	DMSW 08000R													4 5		4 5 6		6 8		6	8	10
Shank	DMSL 06000E	2	2	3 4	3 4	4 5		4 5	5	5 6	5	6										
	DMSL 06000EL	2	2	3	3	4		4	5	5	5	6										
	DMSW 08000E										2	3		3		4						
	DMSW 08000EL										2	3		3		4						
Modular	DMSL 06000M	2	2	3 4	3 4	4 5	4	4 5	5	5 6	5	6	6									
	DMSW 08000M										2	3	3									

* Different shank diameters in stock

Chipbreaker (DMSL)

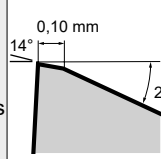
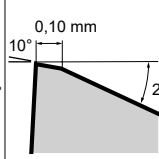
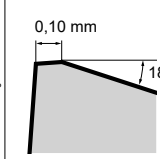
Work Material	P M K S			P M K H		
Applications	Light cutting	General purpose (standard)	Heavy cutting			
Features	Low cutting force type	General purpose type	High strength type			
Chip breaker	L	G	H			
						
Cutting edge cross section						
	4 corners	4 corners	4 corners			

Chipbreaker (DMSW)

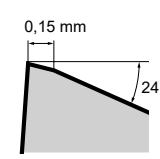
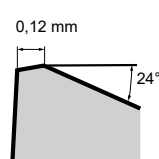
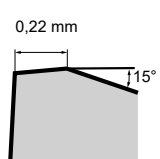
Work Material	P M K S			P M K H		
Applications	Light cutting	General purpose (standard)	Heavy cutting			
Features	Low cutting force type	General purpose type	High strength type			
Chip breaker	L	G	H			
						
Cutting edge cross section						
	6 corners	6 corners	6 corners			

■ Features

- A small chip cross-section due to a small approach angle enables high feed rates per tooth. Feed rate 3,5mm/t is possible.

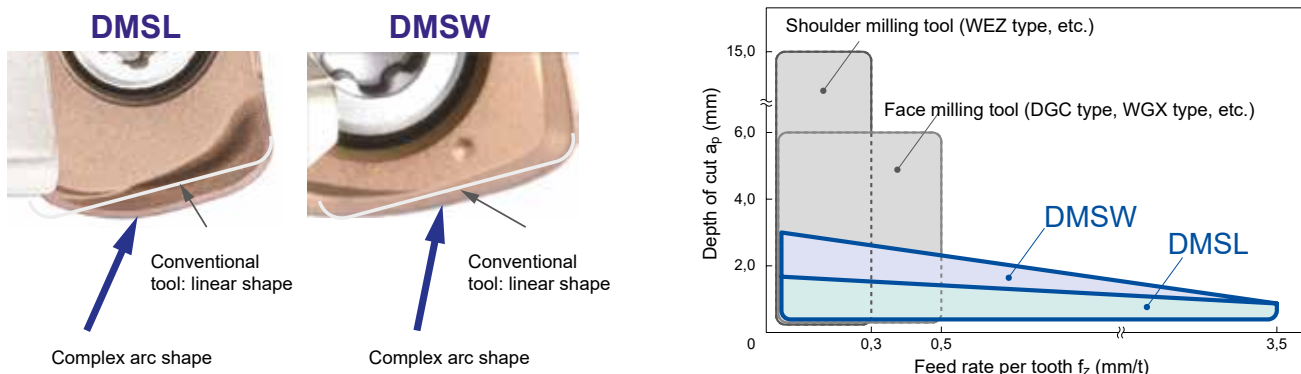

- Even at high feed rates of 2,0 mm/t or more, a reasonable surface finish can be attained.

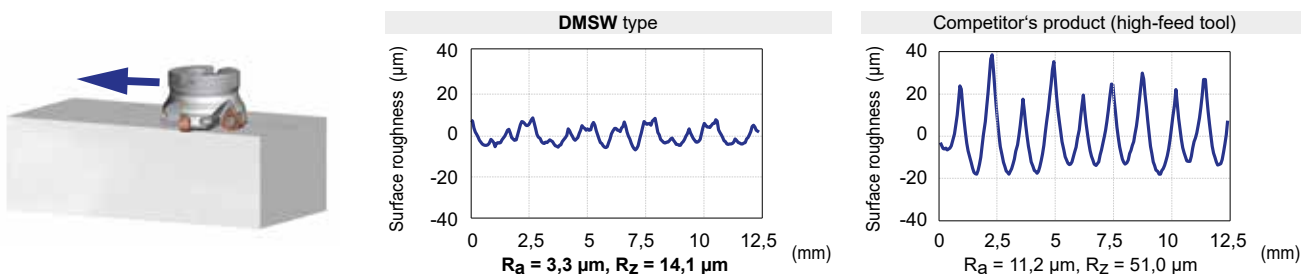

Machine:	Vertical machining centre BT50,	Work material:	C50	Insert:	WNMU 0807ZNER-G (ACU2500)
Tool:	DMSW 08063RS04	Cutting data:	$v_c = 150 \text{ m/min}$, $f_z = 2,5 \text{ mm/t}$, $a_p = 0,5 \text{ mm}$, $a_e = 40 \text{ mm}$, dry		

- Small approach angle (15°) directs most of cutting force in the axial direction and reduces the radial forces. High efficiency can be achieved by suppressing chatter in even long tool overhang machining.

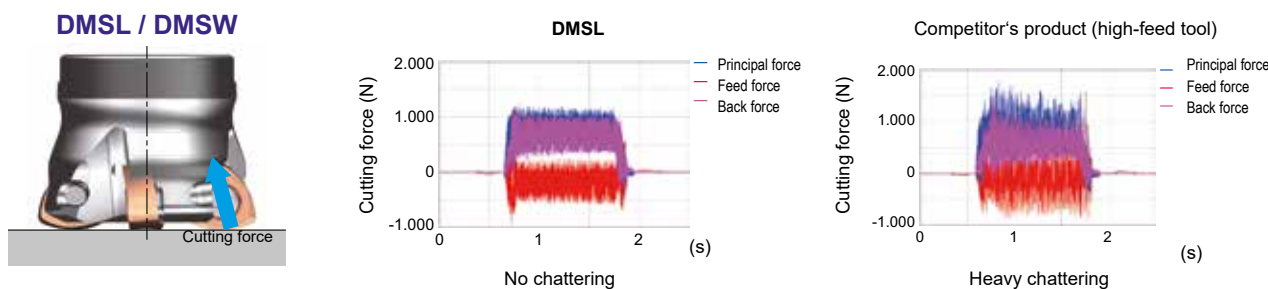

Machine:	Vertical machining centre BT50,	Work material:	C50
Tool:	DMSL 06020E03 (D = $\varnothing 20$, 3 teeth)		
Insert:	LNMU 06T3ZNER-G (ACU2500)		
Cutting data:	$v_c = 160 \text{ m/min}$, $f_z = 0,60 \text{ mm/t}$, $a_p = 0,80 \text{ mm}$, $a_e = 20 \text{ mm}$, L = 100 mm, dry		

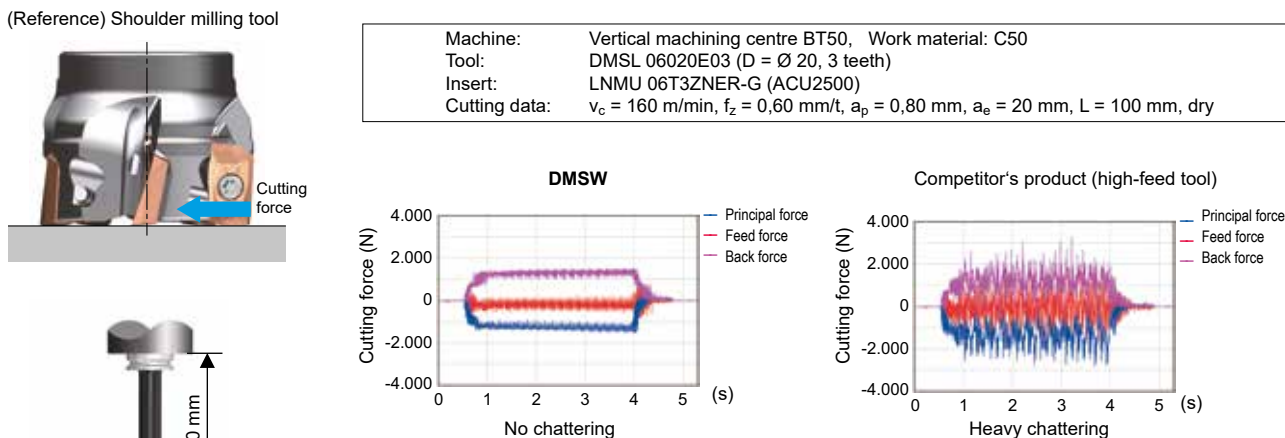

Machine:	Vertical machining centre BT50,	Work material:	C50
Tool:	DMSW 08050RS04 (D = $\varnothing 50$, 4 teeth)		
Insert:	WNMU 0807ZNER-G (ACU2500)		
Cutting data:	$v_c = 160 \text{ m/min}$, $f_z = 0,65 \text{ mm/t}$, $a_p = 0,80 \text{ mm}$, $a_e = 45 \text{ mm}$, L = 340 mm, dry		

Sumi Dual Mill DMSL / DMSW Series

Grade Application Range

Besides grade XCU2500, which can be applied to a wide range of materials, new grades XCS2000/ACS2500/ACS3000 are also released, which are ideal for machining titanium alloys, heat-resistant alloys and stainless steels.

ISO	Coated carbide	Finishing to light cutting	Medium cutting	Rough to heavy cutting
P	Coated carbide		ACU2500	
			XCU2500	
			ACP2000	
			ACP3000	
M S	Coated carbide		ACU2500	
			XCU2500	
			XCS2000	
			ACS2500	
			ACS3000	
K	Coated carbide		ACU2500	
			XCU2500	
			ACK2000	
			ACK3000	

The letters „C“ and „P“ at the end of each grade indicate the coating type.

Grade Features

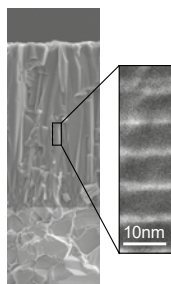

Pure cubic crystal AlTiN with high Al content:

With proprietary structural control technology, differently composed layers of AlTiN are stacked at the nanometre level.

With a high-Al composition containing over 80% Al on average, it also maintains a cubic crystalline structure to achieve excellent thermal resistance and high hardness. Vastly improved wear resistance.

Special Surface Treatment:

Proprietary surface treatment introduces high compression stress to the coating, suppressing the development of cracks. Greatly improved fracture and thermal crack resistance.

Applicable grades: XCS2000, XCU2500

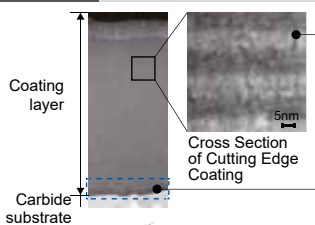

New Super Multi-Layered Structure

Higher hardness and twice the conventional wear resistance due to a fine crystal structure. AlTiCrBN-based nano-layered coating

High Adhesion Strength

Coating adhesion significantly increased for twice or more the conventional chipping resistance.

Applicable grades: ACU2500, ACS3000

Grade Characteristic Values

ISO	Grade	Hardness (HRA)	TRS (GPa)	Coating type	Coating thickness (µm)	Features
P	ACU2500	91,6	3,8	Absotech	3	General purpose grade supporting steel, stainless steel and cast iron machining. Adopts a carbide substrate with excellent fracture resistance and wear resistance, plus a new coating with excellent wear resistance and chipping resistance, realising stable long tool life on various work materials.
	XCU2500	89,5	3,2	Absotech X	6	General purpose grade for wide range of materials, such as steel, stainless steel and cast iron. Longer tool life can be realized in machining from middle to high speed, thanks to new developed coating with balance of wear-resistance and fracture resistance.
	ACP2000	89,5	3,2	Absotech	10	For high-speed machining of steel. Stable long tool life in high-speed machining is realised by adopting a tough carbide substrate and a new coating with excellent thermal crack resistance.
	ACP3000	89,5	3,2	Absotech	3	Our 1st recommended grade for milling steel. Carbide substrate with excellent thermal crack resistance plus a new coating with excellent wear resistance and chipping resistance, realises stable long tool life over a wide range of cutting conditions.
M S	XCS2000	89,8	3,4	Absotech X	4	New coating combining wear and fracture resistance realises superb long tool life in medium to high speed machining of heat resistant alloys and stainless steel.
	ACS2500	90,8	4,2	Absotech	3	Coating with excellent wear and adhesion resistance provides outstanding performance especially in machining titanium alloys.
	ACS3000	89,8	3,4	Absotech	3	High toughness carbide substrate and a coating with excellent chipping resistance provide outstanding stability in wide range of work materials, such as heat-resistant alloys, stainless steel, and titanium alloys.
K	ACK2000	91,7	3,1	Absotech	10	For high-speed cast iron milling. Stable long tool life in high-speed machining is realised by adopting a tough carbide substrate and a new coating with excellent thermal resistance.
	ACK3000	91,7	3,1	Absotech	3	Our 1st recommended grade for milling cast iron. Adopts a high thermal conductivity carbide substrate and a new coating with excellent wear resistance and chipping resistance, realising stable long tool life over a wide range of cast iron machining operations.

Precautions for Corner Finishing

Actual machined corners will have uncut and overcut portions due to the shape of the inserts.

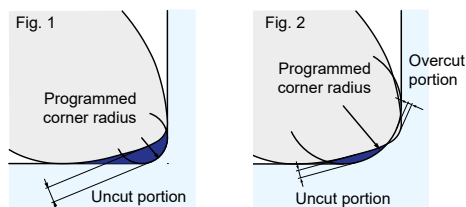

DMSL			
Programmed corner radius	Uncut portion	Overcut portion	Fig.
0,5	0,88	0	1
1,0	0,69	0	1
1,5	0,54	0	1
2,0	0,41	0,02	2

DMSW			
Programmed corner radius	Uncut portion	Overcut portion	Fig.
2,0	1,22	0	1
2,5	1,08	0	1
3,0	0,95	0	1
3,5	0,83	0,04	2

Ramping/Helical Milling Upper Limit

Ramping

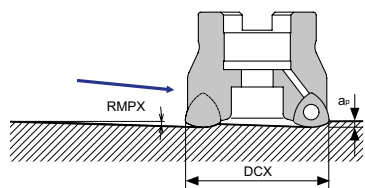

Helical Milling

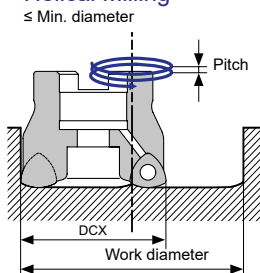

Below the min. machining diameter:
Centre uncut portion cannot be removed
by traverse cutting with the same cutter.

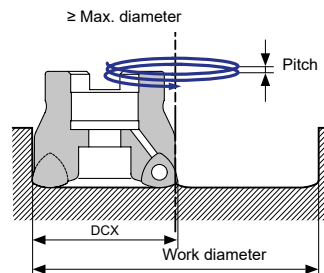

Above the max. machining diameter:
Centre uncut portion can be removed by traverse
cutting with the same cutter.

DMSL

Max. dia. DCX (mm)	Ramping		Helical milling				
	Max. ramping angle RPMX (°)	Max. machining dia. (mm)	Max. pitch (mm/rev)	Standard diameter (mm)	Max. pitch (mm/rev)	Min. machining dia. (mm)	Max. pitch (mm/rev)
16	0,6	31,3	0,6	24,4	0,3	23,8	0,25
18	0,8	35,3	0,8	28,3	0,4	27,2	0,3
20	1,0	39,3	1,0	32,3	0,6	30,5	0,3
22	1,0	43,3	1,0	36,3	0,7	34,3	0,3
25	1,0	49,3	1,0	42,3	0,9	39,9	0,3
26	1,0	51,3	1,0	44,3	0,9	41,8	0,3
28	0,9	55,3	1,0	48,2	0,9	45,7	0,3
30	0,8	59,3	1,0	52,2	1,0	49,6	0,3
32	0,7	63,3	1,0	56,2	1,0	53,6	0,3
35	0,6	69,3	1,0	62,2	1,0	59,5	0,3
40	0,5	79,3	1,0	72,2	1,0	69,5	0,3
42	0,5	83,3	1,0	76,2	1,0	73,5	0,3
50	Not recommended						
52							
63							
66							
80							

DMSW

Max. dia. DCX (mm)	Ramping		Helical milling				
	Max. ramping angle RPMX (°)	Max. machining dia. (mm)	Max. pitch (mm/rev)	Standard diameter (mm)	Max. pitch (mm/rev)	Min. machining dia. (mm)	Max. pitch (mm/rev)
35	0,5	69,3	1,3	53,5	0,5	52,0	0,5
40	0,8	79,3	2,0	63,4	1,0	60,2	0,5
42	0,8	83,3	2,0	67,4	1,0	63,9	0,5
50	1,4	99,3	2,0	83,3	2,0	79,1	1,0
52	1,4	103,3	2,0	87,3	2,0	82,8	1,0
63	1,2	125,3	2,0	109,3	2,0	103,6	1,0
66	1,2	131,3	2,0	115,3	2,0	109,4	1,0
80	1,2	159,3	2,0	143,2	2,0	134,0	1,0
85	1,2	169,3	2,0	153,2	2,0	144,0	1,0
100	0,8	199,3	2,0	183,2	2,0	174,0	1,0
125	Not recommended						
160							

Plunge Cutting Upper Limit

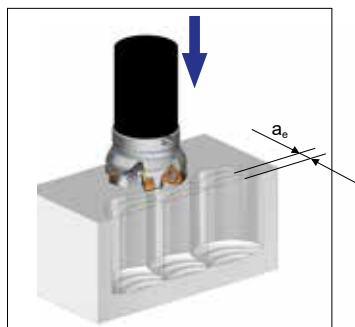

	Max. a_e (mm)	Max. f_z (mm/t)
DMSL	4	0,2
DMSW	10	0,2

Sumi Dual Mill

DMSL 06000 R(S) Type

Rake angle	Radial	-8° to -12,5°	
	Axial	-8°	

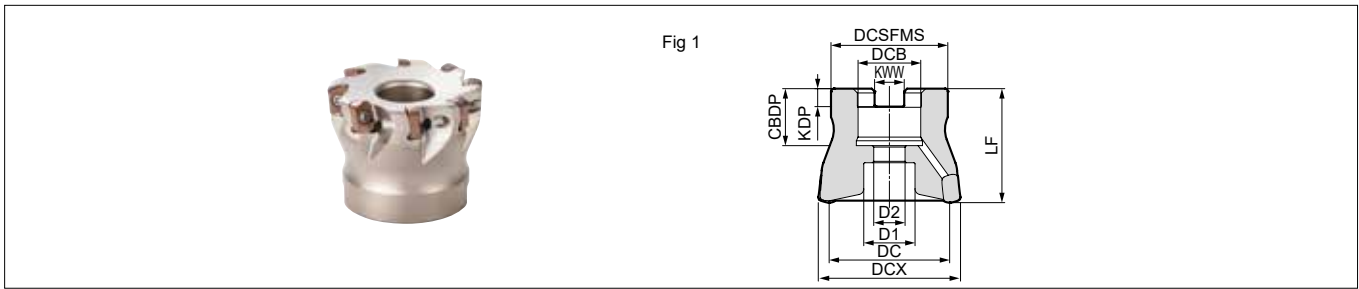

■ Body (Shell Type)



Dimensions (mm)

Cat. No.		Stock	DCX	DC	DCSFMS	LF	DCB	KWW	KDP	CBDP	D1	D2	Number of teeth	Weight (kg)	Fig.
Metric	DMSL 06040RS05	●	40	32,3	33	40	16	8,4	5,6	18	14	9	5	0,20	1
	06040RS06	●	40	32,3	33	40	16	8,4	5,6	18	14	9	6	0,20	1
	06040RS07	●	40	32,3	33	40	16	8,4	5,6	18	14	9	7	0,20	1
	06042RS06	●	42	34,3	33	40	16	8,4	5,6	18	14	9	6	0,21	1
	06050RS05	●	50	42,3	41	40	22	10,4	6,3	20	18	11	5	0,31	1
	06050RS08	●	50	42,3	41	40	22	10,4	6,3	20	18	11	8	0,30	1
	06052RS08	●	52	44,3	41	40	22	10,4	6,3	20	18	11	8	0,31	1
	06063RS08	●	63	55,3	50	40	22	10,4	6,3	20	18	11	8	0,52	1
	06063RS09	●	63	55,3	50	40	22	10,4	6,3	20	18	11	9	0,52	1
	06066RS08-27	●	66	58,3	55	50	27	12,4	7	22	20	14	8	0,69	1
06080RS09	●	80	72,3	55	50	27	12,4	7	22	20	14	9	0,94	1	
Inch	DMSL 06050R05	○	50	42,3	41	40	22,225	8,4	5	20	18	11	5	0,32	1
	06050R08	○	50	42,3	41	40	22,225	8,4	5	20	18	11	8	0,30	1
	06063R08	○	63	55,3	50	40	22,225	8,4	5	20	18	11	8	0,53	1

Take note of the cutter mounting size (DCB) when selecting a cutter. Inserts are sold separately.

 For mounting the cutters marked with * to an arbor, use a JIS B1176 hexagonal socket bolt (M12x30 to 35 mm).

■ Parts

Insert screw		Wrench
		
BFTX02507IP	2,0	TRDR08IP

■ Identification Details

DMSL	06	066	R	S	08	-	27
Cutter series	Insert size	Cutter diameter	Feed direction	Metric	Number of teeth		Mounting size

■ Inserts

→ P.9

■ Recommended Cutting Conditions

→ P.9

● = Euro stock

○ = Japan stock

Rake angle	Radial	-12,5° to -16,5°	1,5mm 17°
	Axial	-8°	

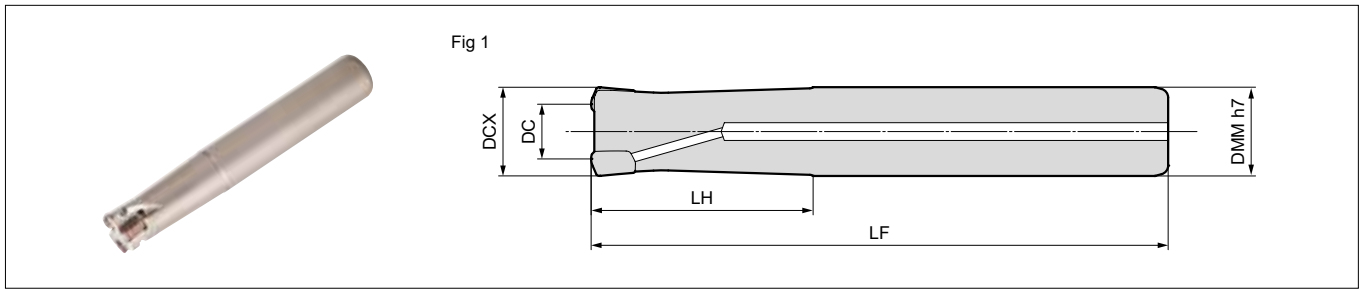

■ Body (Shank Type)

Dimensions (mm)

Cat. No.	Stock	DCX	DC	DMM	LH	LF	Number of teeth	Weight (kg)	Fig.
DMSL 06016E02	●	16	8,4	16	30	110	2	0,15	1
06018E02	●	18	10,4	16	30	110	2	0,15	1
06020E03	●	20	12,4	20	50	130	3	0,27	1
06020E04	●	20	12,4	20	50	130	4	0,27	1
06022E03	○	22	14,3	20	50	130	3	0,29	1
06022E04	○	22	14,3	20	50	130	4	0,29	1
06025E04	●	25	17,3	25	60	140	4	0,46	1
06025E05	●	25	17,3	25	60	140	5	0,46	1
06028E04	○	28	20,3	25	60	140	4	0,49	1
06028E05	○	28	20,3	25	60	140	5	0,48	1
06030E05	●	30	22,3	32	70	150	5	0,81	1
06032E05	●	32	24,3	32	70	150	5	0,82	1
06032E06	●	32	24,3	32	70	150	6	0,82	1
06035E05	○	35	27,3	32	50	150	5	0,88	1
06035E06	●	35	27,3	32	50	150	6	0,88	1
06040E06	●	40	32,3	32	50	150	6	0,91	1

Inserts are sold separately.

■ Body (Long Shank Type)

Dimensions (mm)

Cat. No.	Stock	DCX	DC	DMM	LH	LF	Number of teeth	Weight (kg)	Fig.
DMSL 06016EL02	●	16	8,4	16	70	150	2	0,19	1
06018EL02	○	18	10,4	16	50	150	2	0,21	1
06020EL03	●	20	12,4	20	80	160	3	0,33	1
06022EL03	○	22	14,3	20	60	160	3	0,36	1
06025EL04	●	25	17,3	25	100	170	4	0,54	1
06028EL04	○	28	20,3	25	60	170	4	0,60	1
06030EL05	○	30	22,3	32	120	200	5	1,01	1
06032EL05	●	32	24,3	32	120	200	5	1,06	1
06035EL05	○	35	27,3	32	60	210	5	1,21	1
06040EL06	●	40	32,3	32	60	210	6	1,24	1

Inserts are sold separately.

■ Parts

Insert screw	Wrench
BFTX02507IP	2,0 TRDR08IP

■ Identification Details

DMSL 06 025 E L 04

Cutter series	Insert size	Cutter diameter	Shank	Long shank type	Number of teeth
---------------	-------------	-----------------	-------	-----------------	-----------------

■ Inserts

→ P.9

■ Recommended Cutting Conditions

→ P.9

Rake angle	Radial	-12,5° to -16,5°	1,5mm 17°
	Axial	-8°	

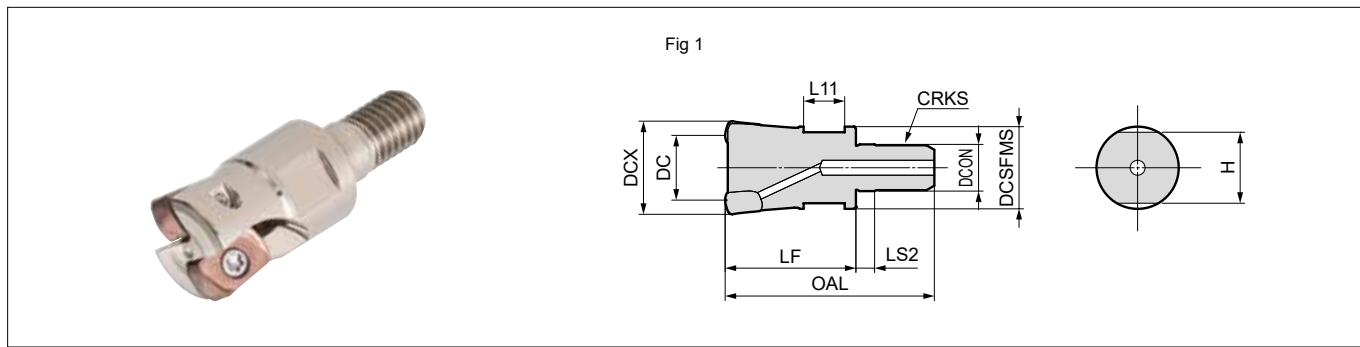

Head

Dimensions (mm)

Cat. No.	Stock	DCX	DC	DCSFMS	DCON	CRKS	OAL	LF	LS2	L11	H	Number of teeth	Weight (kg)	Fig.
DMSL 06016M08Z2	●	16	8,4	14,5	8,5	M8	42	25	5	8	13	2	0,03	1
06018M08Z2	○	18	10,4	14,5	8,5	M8	42	25	5	8	13	2	0,03	1
06020M10Z3	●	20	12,4	18	10,5	M10	49	30	5	10	15	3	0,05	1
06020M10Z4	●	20	12,4	18	10,5	M10	49	30	5	10	15	4	0,05	1
06022M10Z3	○	22	14,3	18	10,5	M10	49	30	5	10	15	3	0,06	1
06022M10Z4	○	22	14,3	18	10,5	M10	49	30	5	10	15	4	0,06	1
06025M12Z4	●	25	17,3	22	12,5	M12	56	35	5	11	19	4	0,10	1
06025M12Z5	●	25	17,3	22	12,5	M12	56	35	5	11	19	5	0,10	1
06026M12Z4	●	26	18,3	22	12,5	M12	56	35	5	11	19	4	0,10	1
06028M12Z4	●	28	20,3	22	12,5	M12	56	35	5	11	19	4	0,11	1
06028M12Z5	●	28	20,3	22	12,5	M12	56	35	5	11	19	5	0,11	1
06030M16Z5	○	30	22,3	28,5	17	M16	63	40	5	12	24	5	0,18	1
06032M16Z5	●	32	24,3	28,5	17	M16	63	40	5	12	24	5	0,20	1
06032M16Z6	●	32	24,3	28,5	17	M16	63	40	5	12	24	6	0,20	1
06035M16Z5	●	35	27,3	28,5	17	M16	63	40	5	12	24	5	0,21	1
06035M16Z6	●	35	27,3	28,5	17	M16	63	40	5	12	24	6	0,21	1
06040M16Z6	●	40	32,3	28,5	17	M16	63	40	5	12	24	6	0,25	1
06042M16Z6	●	42	34,3	28,5	17	M16	63	40	5	12	24	6	0,26	1
06042M16Z7	●	42	34,3	28,5	17	M16	63	40	5	12	24	7	0,26	1

Inserts are sold separately.

Parts

Insert screw	Wrench
BFTX025071P	2,0 TRDR081P

Identification Details

DMSL	06	025	M12	Z4
Cutter series	Insert size	Cutter diameter	Mounting screw size	Number of teeth

Modular Tool System



→ P.13

Inserts

Dimensions (mm)

Application	Coated carbide											
High speed / Light cut		P		K		PS						
General purpose	PS	P	P	K	K	PS	MS	MS	MS			
Roughing	PS		P		K		MS	MS	MS			
Cat. No.	ACU2500	ACP2000	ACP3000	ACK2000	ACK3000	XCU2500	XCS2000	ACS2500	ACS3000	RE	Fig.	
LNMU 06T3ZNER-L	●	●	●				●	●	●	1,0	1	
LNMU 06T3ZNER-G	●	●	●	●	●	●	●	●	●	1,0	1	
LNMU 06T3ZNER-H	●	●	●				●	●	●	1,0	1	

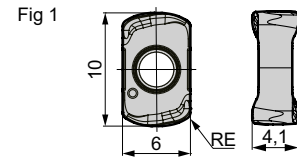

Recommended Cutting Conditions

min.–optimum–max.

ISO	Work material	Hardness	Cutting speed v_c (m/min)	Feed rate f_z (mm/t)	Grade
P	General steel	< 280 HB	100– 160 –250	1,0– 1,5 –2,0	ACU2500/ACP2000/ACP3000
	Alloy steel	< 280 HB	100– 160 –200	1,0– 1,5 –1,8	
	Alloy steel	< 42 HRC	100– 150 –180	0,8– 1,0 –1,2	
M	Stainless steel	–	80– 120 –150	0,8– 1,0 –1,2	ACU2500/ACS2500/ACS3000
K	Cast iron	–	100– 160 –250	1,0– 1,5 –1,8	ACU2500/ACK2000/ACK3000
S	Heat Resistant Alloy	–	20– 30 –40	0,3– 0,5 –0,7	ACU2500/ACS2500/ACS3000
	Titanium Alloy	–	30– 50 –70	0,4– 0,6 –0,8	
H	Hardened steel	< 52 HRC	80– 100 –120	0,3– 0,5 –0,7	ACU2500/ACP3000

The above figures are guidelines for use with BT50 machine tools at depth of cut (a_p) of 0,75 mm.
The above recommended cutting conditions may require adjustment depending on machine rigidity and workpiece rigidity.

Sumi Dual Mill

DMSW 08000 R(S) Type

Rake angle	Radial	-7° to -10°	
	Axial	-6°	

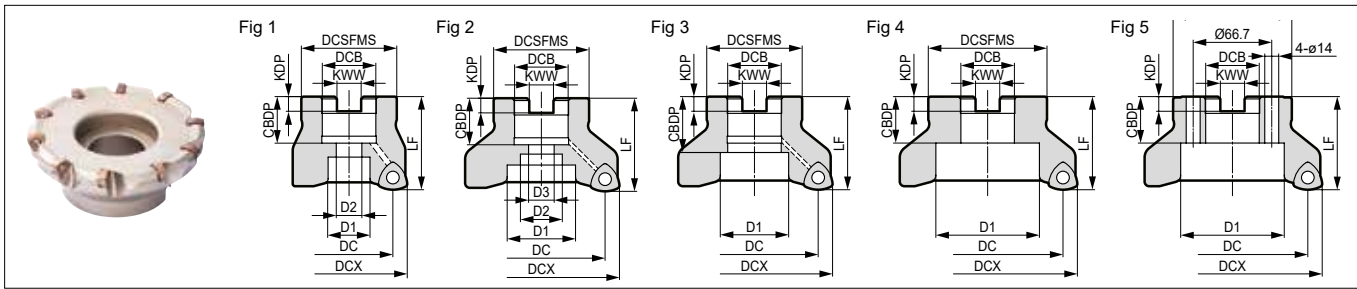

■ Body (Shell Type)

Dimensions (mm)

	Cat. No.	Stock	Dimensions (mm)											Number of teeth	Weight (kg)	Fig.
			DCX	DC	DCSFMS	LF	DCB	KWW	KDP	CBBDP	D1	D2	D3			
Metric	DMSW 08050RS04	●	50	33,4	41	40	22	10,4	6,3	20	16,7	11	—	4	0,25	1
	08050RS05	●	50	33,4	41	40	22	10,4	6,3	20	16,7	11	—	5	0,24	1
	08052RS04	●	52	35,4	41	40	22	10,4	6,3	20	17	11	—	4	0,27	1
	08052RS05	●	52	35,4	41	40	22	10,4	6,3	20	17	11	—	5	0,25	1
	08063RS04	●	63	46,4	50	40	22	10,4	6,3	20	18	11	—	4	0,46	1
	08063RS05	●	63	46,4	50	40	22	10,4	6,3	20	18	11	—	5	0,46	1
	08063RS06	●	63	46,4	50	40	22	10,4	6,3	20	18	11	—	6	0,44	1
	08063RS05-27	●	63	46,4	50	50	27	12,4	7	22	20	14	—	5	0,55	1
	08063RS06-27	●	63	46,4	50	50	27	12,4	7	22	20	14	—	6	0,53	1
	08066RS05-27	●	66	49,4	50	50	27	12,4	7	22	20	14	—	5	0,60	1
	08066RS06-27	●	66	49,4	50	50	27	12,4	7	22	20	14	—	6	0,58	1
	08080RS06	●	*80	63,3	55	50	27	12,4	7	22	20	14	—	6	0,88	1
	08080RS08	●	*80	63,3	55	50	27	12,4	7	22	20	14	—	8	0,84	1
	08100RS06	●	100	83,3	70	50	32	14,4	8	32	46	—	—	6	1,29	3
08125RS08	●	125	108,3	80	63	40	16,4	9	29	52	29	—	8	2,41	1	
08160RS10	●	160	143,3	130	63	40	16,4	9	29	90	—	—	10	4,73	5	
Inch	DMSW 08050R04	○	50	33,4	41	40	22,225	8,4	5	20	16,7	11	—	4	0,25	1
	08050R05	○	50	33,4	41	40	22,225	8,4	5	20	16,7	11	—	5	0,24	1
	08063R04	○	63	46,4	50	40	22,225	8,4	5	20	18	11	—	4	0,46	1
	08063R05	○	63	46,4	50	40	22,225	8,4	5	20	18	11	—	5	0,46	1
	08063R06	○	63	46,4	50	40	22,225	8,4	5	20	18	11	—	6	0,44	1
	08080R06	○	*80	63,3	70	63	31,75	12,7	8	32	27	18	—	6	1,32	1
	08080R08	○	*80	63,3	70	63	31,75	12,7	8	32	27	18	—	8	1,28	1
	08100R06	○	*100	83,3	70	63	31,75	12,7	8	32	46	27	18	6	1,75	2
	08125R08	○	125	108,3	80	63	38,1	15,9	10	35,5	55	30	—	8	2,55	1
	08160R10	○	160	143,3	100	63	50,8	19,1	11	38	72	—	—	10	4,18	4

Take note of the cutter mounting size (DCB) when selecting a cutter. Inserts are sold separately.

For mounting the Ø 80 mm, Ø 85 mm and Ø 100 mm sized cutters marked with * to an arbor, use a JIS B1176 hexagonal socket bolt (metric specification : M12x30 to 35 mm, inch specification: M16x40 to 45 mm).

■ Parts

Applicable cutters	Insert screw		Wrench	Handle grip	Wrench bit
DMSW 08160R(S)10 Other than above	BFTX0513IP	5,0	TRDR20IP	—	—
			—	HPL2025	TPB20IP

■ Identification Details

DMSW 08	063	R	S	05 - 27
Cutter series	Insert size	Cutter diameter	Feed direction	Metric Number of teeth Mounting size

■ Inserts

→ P. 12

■ Recommended Cutting Conditions

→ P. 12

● = Euro stock

○ = Japan stock

Sumi Dual Mill DMSW 08000 E(L) Type

Rake angle	Radial Axial	-7° to -10° -6°	3 mm 15°
------------	--------------	--------------------	-------------

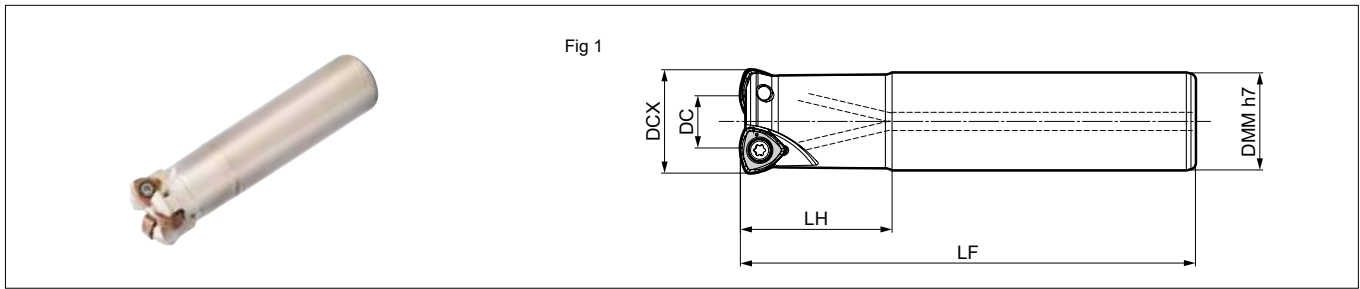

Body (Shank Type)

									Dimensions (mm)	
Cat. No.	Stock	DCX	DC	DMM	LH	LF	Number of teeth	Weight (kg)	Fig.	
DMSW 08035E02	●	35	18,6	32	50	150	2	0,85	1	
08040E03	●	40	23,5	32	50	150	3	0,86	1	
08050E03-42	●	50	33,4	42	50	150	3	1,51	1	

Inserts are sold separately.

Body (Long Shank Type)

									Dimensions (mm)	
Cat. No.	Stock	DCX	DC	DMM	LH	LF	Number of teeth	Weight (kg)	Fig.	
DMSW 08035EL02	●	35	18,6	32	60	210	2	1,21	1	
08040EL03	●	40	23,5	32	60	210	3	1,22	1	
08050EL03-42	●	50	33,4	42	50	250	3	2,54	1	

Inserts are sold separately.

Parts

Insert screw		Wrench
BFTX0513IP	5,0	TRDR20IP

Identification Details

DMSW	08	050	E	L	03	-	42
Cutter series	Insert size	Cutter diameter	Shank	Long shank type	Number of teeth		Shank diameter

Inserts

→ P. 12

Recommended Cutting Conditions

→ P. 12

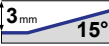
Rake angle	Radial	-11° to -13°	
	Axial	-6°	

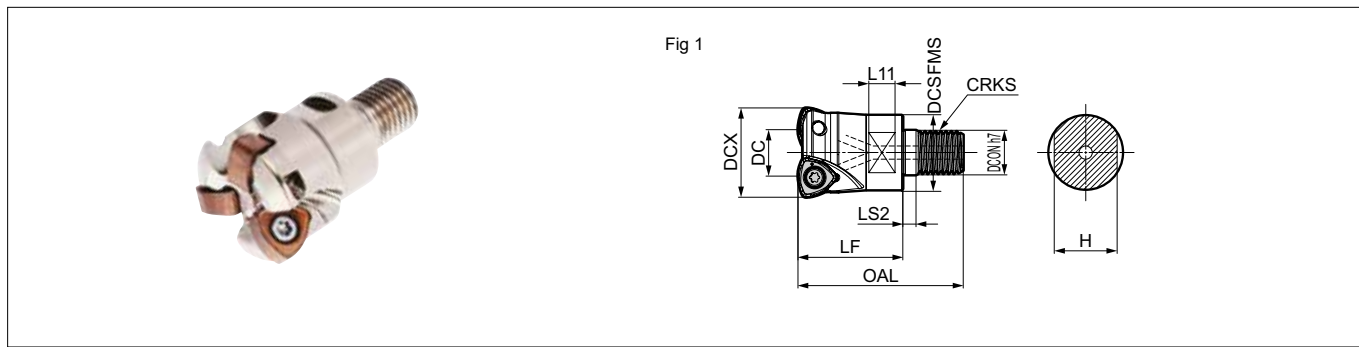



Head

Dimensions (mm)

Cat. No.	Stock	DCX	DC	DCSFMS	DCON	CRKS	OAL	LF	LS2	L11	H	Number of teeth	Weight (kg)	Fig.
DMSW 08035M16Z2	●	35	18,6	28,5	17	M16	63	40	5	10	24	2	0,19	1
08040M16Z3	●	40	23,5	28,5	17	M16	63	40	5	10	24	3	0,21	1

Inserts are sold separately.

Parts

Insert screw		Wrench
		
BFTX02507IP	5,0	TRDR08IP

Identification Details

DMSW 08 040 M16 Z3

Cutter series Insert size Cutter diameter Mounting screw size Number of teeth

Inserts

Dimensions (mm)

























Application	Coated carbide									IC	S	RE	Fig.
													
High speed / light cut													
General purpose													
Roughing													
Cat. No.	ACU2500	ACP2000	ACP3000	ACK2000	ACK3000	XCU2500	XCS2000	ACS2500	ACS3000				
WNMU 0807ZNER-L	●	●	●	●	●	●	●	●	●	13	7	1,6	1
WNMU 0807ZNER-G	●	●	●	●	●	●	●	●	●	13	7	1,6	1
WNMU 0807ZNER-H	●	●	●	●	●	●	●	●	●	13	7	1,6	1

Fig 1



Recommended Cutting Conditions

min.–optimum–max.

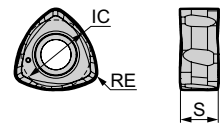
ISO	Work material	Hardness	Cutting speed v_c (m/min)	Feed rate f_z (mm/t)	Grade
P	General steel	< 280 HB	100–160–250	1,0–1,5–2,0	ACU2500/ACP2000/ ACP3000
	Alloy steel	< 280 HB	100–160–200	1,0–1,5–1,8	
	Alloy steel	< 42 HRC	100–150–180	0,8–1,0–1,2	
M	Stainless steel	–	80–120–150	0,8–1,0–1,2	ACU2500/ACS2500/ACS3000
K	Cast iron	–	100–160–250	1,0–1,5–1,8	ACU2500/ACK2000/ACK3000
S	Heat Resistant Alloy	–	20–30–40	0,3–0,5–0,7	ACU2500/ACS2500/ACS3000
	Titanium Alloy	–	30–50–70	0,4–0,6–0,8	
H	Hardened steel	< 52 HRC	80–100–120	0,3–0,5–0,7	ACU2500/ACP3000

The above figures are guidelines for use with BT50 machine tools at depth of cut (a_e) of 1,5 mm.

The above recommended cutting conditions may require adjustment depending on machine rigidity and workpiece rigidity.

BBT Integrated Type - Modular Tools Special Arbor

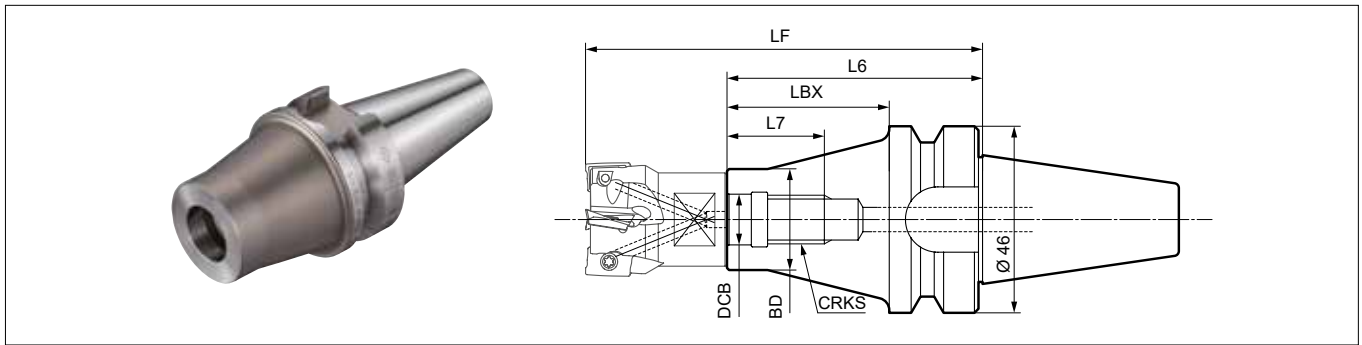

BBT Integrated Arbor

Dimensions (mm)

Cat. No.	Stock	CRKS	DCB	BD	L6	LBX	L7	LF*	Coolant hole
BBT30- M8-50	○	M8	8,5	15,9	72	50	18	97	yes
BBT30- M10-45	○	M10	10,5	19,9	67	45	20	97	yes
BBT30- M12-40	○	M12	12,5	24,9	62	40	22	97	yes
BBT30- M16-35	○	M16	17	31,9	57	35	24	97	yes

* Overhang length for LF is with head mounted. Can also be used with BT30 special machines.

Carbide and Steel Arbor

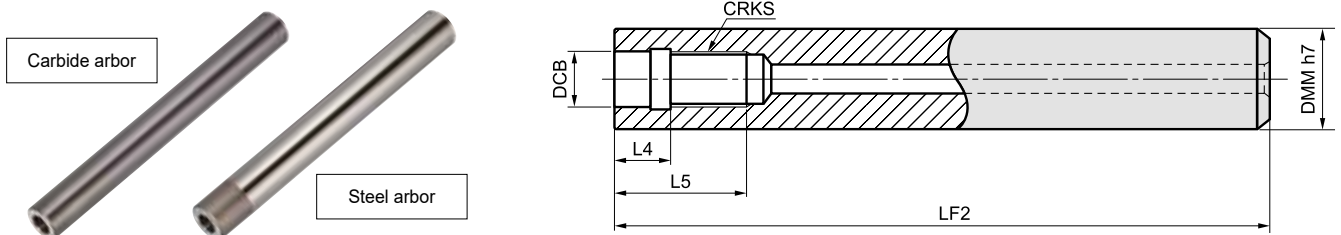

Carbide Arbor

Dimensions (mm)

Cat. No.	Stock	CRKS	DCB	DMM	LF2	L4	L5	LF*
MA 15 M08 L120C	●	M8	8,5	15	120	10	18	145
15 M08 L160C	●	M8	8,5	15	160	10	18	185
MA 16 M08 L120C	●	M8	8,5	16	120	10	18	145
16 M08 L160C	●	M8	8,5	16	160	10	18	185
MA 18 M10 L150C	●	M10	10,5	18	150	10	20	180
18 M10 L200C	●	M10	10,5	18	200	10	20	230
MA 20 M10 L150C	●	M10	10,5	20	150	10	20	180
20 M10 L200C	○	M10	10,5	20	200	10	20	230
MA 23 M12 L200C	●	M12	12,5	23	200	10	22	235
23 M12 L250C	●	M12	12,5	23	250	10	22	285
MA 25 M12 L200C	●	M12	12,5	25	200	10	22	235
25 M12 L250C	●	M12	12,5	25	250	10	22	285
MA 28 M16 L200C	●	M16	17,0	28	200	10	24	240
28 M16 L300C	●	M16	17,0	28	300	10	24	340
MA 32 M16 L200C	●	M16	17,0	32	200	10	24	240
32 M16 L300C	●	M16	17,0	32	300	10	24	340

Steel Arbor

Dimensions (mm)

Cat. No.	Stock	CRKS	DCB	DMM	LF2	L4	L5	LF*
MA 16 M08 L120S	●	M8	8,5	16	120	10	18	145
MA 20 M10 L150S	●	M10	10,5	20	150	10	20	180
MA 25 M12 L200S	●	M12	12,5	25	200	10	22	235
MA 32 M16 L200S	●	M16	17,0	32	200	10	24	240

Identification Details

MA 15 M08 L120 C

Modular arbor Shank diameter Mounting screw Arbor length Material
C: carbide
S: steel

Recommended Tightening Torque

Notes about tightening the head:

When mounting the head to an arbor, follow the attached tightening torque in the table below.

Check the mounting screw diameter for the head and arbor beforehand.

Screw size	Tightening torque
	(N·m)
M8	23
M10	46
M12	60
M16	80



* Modular Tool System





Application Examples

General steel St42-3, machine part		Sumitomo	Competitor
	Tool	DMSL06020M10Z3	Double sided, 6 corners
	Grade	ACU2500	–
	Chipbreaker	G	–
	Cutter diam. (mm)	20	50
	Number of teeth	3	4
	v_c (m/min)	94	130
	v_f (mm/min)	4.000	2.500
	f_z (mm/t)	0,89	0,6
	a_p (mm)	1	0,5
	a_e (mm)	20	35
	Coolant	wet	wet
	Results	The 120 mm overhang (using a carbide arbor) allows the machine to achieve double efficiency without any vibration even when the feed rate is increased	

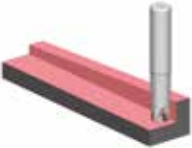
Carbon steel C40, automotive parts		Sumitomo	Competitor
	Tool	DMSL06020M10Z3	Double sided, 4 corners
	Grade	ACU2500	–
	Chipbreaker	G	–
	Cutter diam. (mm)	20	20
	Number of teeth	3	3
	v_c (m/min)	200	160
	v_f (mm/min)	9.000	3.900
	f_z (mm/t)	0,93	0,5
	a_p (mm)	0,35	0,5
	a_e (mm)	20	25
	Coolant	dry	wet
	Results	Stable machining even with a overhang of 130 mm (using a carbide arbor) and 1,3 times higher efficiency.	

Prehardened steel (40HRC), mould parts		Sumitomo	Competitor
	Tool	DMSL06025E04	Single sided, 4 corners
	Grade	ACU2500	–
	Chipbreaker	G	–
	Cutter diam. (mm)	25	32
	Number of teeth	4	4
	v_c (m/min)	190	150
	v_f (mm/min)	9.600	5.970
	f_z (mm/t)	1	1
	a_p (mm)	0,4	0,4
	a_e (mm)	18	25
	Coolant	dry	wet
	Results	Double tool life by changing from wet to dry condition. Stable machining without vibration, even with smaller diameters.	

Precision hardened stainless steel X3CrNiCuNb16-4 (H900), aircraft parts		Sumitomo	Competitor
	Tool	DMSL06025E05	Double sided, 4 corners
	Grade	ACU2500	–
	Chipbreaker	G	–
	Cutter diam. (mm)	25	25
	Number of teeth	5	4
	v_c (m/min)	145	145
	v_f (mm/min)	3.000	2.400
	f_z (mm/t)	0,33	0,33
	a_p (mm)	0,8	0,8
	a_e (mm)	2,5	2,5
	Coolant	wet	dry
	Results	Double tool life (totally 4 piece parts) was achieved.	

Ductile iron GGG-40.3, machine parts		Sumitomo	Competitor
	Tool	DMSL06032M16Z5	–
	Grade	ACU2500	–
	Chipbreaker	G	–
	Cutter diam. (mm)	32	–
	Number of teeth	5	–
	v_c (m/min)	100	–
	v_f (mm/min)	4.970	–
	f_z (mm/t)	1	–
	a_p (mm)	0,4	–
	a_e (mm)	3	–
	Coolant	wet	–
	Results	Stable machining can be achieved by using carbide arbor, even with long overhangs. Significantly high efficiency than boring machining.	

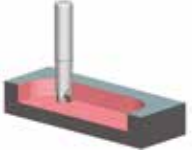
Titanium alloy Ti-6Al-4V, aircraft parts		Sumitomo	Competitor
	Tool	DMSL06025E04	Double sided, 4 corners
	Grade	ACU2500	–
	Chipbreaker	G	–
	Cutter diam. (mm)	25	25
	Number of teeth	4	4
	v_c (m/min)	50	60
	v_f (mm/min)	2.000	1.200
	f_z (mm/t)	0,8	0,4
	a_p (mm)	0,7	0,7
	a_e (mm)	15	15
	Coolant	wet	wet
	Results	Tool life (1,5 times) and efficiency (1,7 times) were increased.	

Application Examples

Tool steel X40CrVMo5-1 (45 HRC), mold		Sumitomo	Competitor
Vertical machining centre BT50 	Tool	DMSW08050RS05	Double sided, 6 corners
	Grade	ACU2500	—
	Chipbreaker	G	—
	Cutter diam. (mm)	50	50
	Number of teeth	5	4
	v_c (m/min)	130	130
	v_f (mm/min)	2.500	2.500
	f_z (mm/t)	0,75	0,6
	a_p (mm)	0,5	0,5
	a_e (mm)	35	35
	Coolant	dry	dry
	Results	Minimal damage to insert even after 50 minutes of machining. Stable chip shape.	

Prehardened steel (40 HRC), test piece		Sumitomo	Competitor
Boring machine BT50 	Tool	DMSW08100R06	Double sided, 6 corners
	Grade	ACP3000	—
	Chipbreaker	G	—
	Cutter diam. (mm)	100	100
	Number of teeth	6	6
	v_c (m/min)	180	120
	v_f (mm/min)	5.160	3.440
	f_z (mm/t)	1,5	1,5
	a_p (mm)	1	1
	a_e (mm)	65	65
	Coolant	dry	dry
	Results	1,5 times efficiency and no chatter were realized by increasing cutting speed even at overhang of 380 mm.	

Tempered steel 42CrMo4 (40 HRC), machine comp.		Sumitomo	Competitor
Horizontal machining centre BT50 	Tool	DMSW08050RS04	Single sided, 3 corners
	Grade	ACU2500	—
	Chipbreaker	G	—
	Cutter diam. (mm)	50	50
	Number of teeth	4	4
	v_c (m/min)	210	210
	v_f (mm/min)	5.825	5.825
	f_z (mm/t)	1,1	1,1
	a_p (mm)	1,5	1,5
	a_e (mm)	25	25
	Coolant	dry	dry
	Results	Stable machining without chipping is possible even with heat-treated work material.	

Alloy steel 25CrMo4, large oil drilling tool		Sumitomo	Competitor
	Tool	DMSW08080R08	—
	Grade	ACU2500	—
	Chipbreaker	G	—
	Cutter diam. (mm)	80	—
	Number of teeth	8	—
	v_c (m/min)	180	—
	v_f (mm/min)	3.400	—
	f_z (mm/t)	0,6	—
	a_p (mm)	1,9	—
	a_e (mm)	57	—
	Coolant	dry	—
	Results	One cutting edge realized to finish one piece of workpiece with 300 minutes machining time.	

Manganese steel construction machine component		Sumitomo	Competitor
Horizontal machining centre BT50 	Tool	DMSW08080RS06	Single sided, 2 corners
	Grade	ACU2500	—
	Chipbreaker	G	—
	Cutter diam. (mm)	80	80
	Number of teeth	6	5
	v_c (m/min)	80	80
	v_f (mm/min)	900	900
	f_z (mm/t)	0,47	0,56
	a_p (mm)	1	1
	a_e (mm)	60	60
	Coolant	wet	wet
	Results	Stable machining with 1,3 times tool life was achieved, when cutting mill-scale in even poor clamping situation.	

Alloy steel 15CrMo5, machine component		Sumitomo	Competitor
Horizontal machining centre BT40 	Tool	DMSW08125RS08	Double sided, 10 corners
	Grade	ACU2500	—
	Chipbreaker	G	—
	Cutter diam. (mm)	125	125
	Number of teeth	8	13
	v_c (m/min)	280	200
	v_f (mm/min)	4.280	2.185
	f_z (mm/t)	0,75	0,33
	a_p (mm)	1,5	2,0
	a_e (mm)	100	100
	Coolant	wet	wet
	Results	Tool life was improved without sudden fracture, meanwhile the efficiency was increased by 1,5 times.	

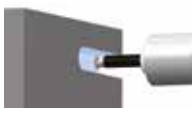
Carbon steel C45, large mold part		Sumitomo	Competitor
Boring machine BT50 	Tool	DMSW08050RS05	Single sided, 4 corners
	Grade	ACU2500	—
	Chipbreaker	G	—
	Cutter diam. (mm)	50	50
	Number of teeth	5	5
	v_c (m/min)	189	189
	v_f (mm/min)	5.000	5.000
	f_z (mm/t)	0,83	0,83
	a_p (mm)	1	1
	a_e (mm)	50	50
	Coolant	wet	wet
	Results	Roughing application was finished in 240 minutes without exchanging cutting edges and inserts, when no chatter was observed with 200 mm long steel arbor.	

Low carbon steel SS400, machine component		Sumitomo	Competitor
Vertical machining centre BT40 	Tool	DMSW08040E03	Double sided, 4 corners
	Grade	ACU2500	—
	Chipbreaker	G	—
	Cutter diam. (mm)	40	32
	Number of teeth	3	6
	v_c (m/min)	150	120
	v_f (mm/min)	3.800	3.800
	f_z (mm/t)	1,0	0,5
	a_p (mm)	0,5	0,5
	a_e (mm)	30	30
	Coolant	wet	wet
	Results	Double tool life was achieved.	

Sumi Dual Mill DMSW Series

Application Examples

Stainless steel X5CrNiS18 10, machine component		Sumitomo	Competitor
Vertical 5-axis machining centre BT50 	Tool	DMSW08080R08	Single sided, 2 corners
	Grade	ACU2500	–
	Chipbreaker	G	–
	Cutter diam. (mm)	80	80
	Number of teeth	8	7
	v_c (m/min)	120	126
	v_f (mm/min)	2.675	490
	f_z (mm/t)	0,7	0,1
	a_p (mm)	1	2
	a_e (mm)	40	40
	Coolant	dry	dry
	Results	Efficiency increased 2.7 times. Tool life increased more than 6 times.	

Gray cast iron GG-25, mold		Sumitomo	Competitor
Vertical machining centre BT50 	Tool	DMSW08100R06	Single sided, 4 corners
	Grade	ACP3000	–
	Chipbreaker	G	–
	Cutter diam. (mm)	100	100
	Number of teeth	6	6
	v_c (m/min)	100	100
	v_f (mm/min)	1.910	1.910
	f_z (mm/t)	1	1
	a_p (mm)	1,5	1,5
	a_e (mm)	50	50
	Coolant	wet	wet
	Results	Tool life was increased without sudden fracture during mill-scale workpiece milling.	

Gray cast iron GG-25, machine component		Sumitomo	Competitor
Vertical machining centre BT50 	Tool	DMSW08063R05	Single sided, 3 corners
	Grade	ACU2500	–
	Chipbreaker	G	–
	Cutter diam. (mm)	63	63
	Number of teeth	5	4
	v_c (m/min)	158	158
	v_f (mm/min)	4.000	1.500
	f_z (mm/t)	1,0	0,47
	a_p (mm)	2	1
	a_e (mm)	50	50
	Coolant	dry	dry
	Results	Efficiency reached to more than 5 times, by adopting more cutting edges and higher feed per tooth as well as.	

Ductile cast iron FCD540, large mold part		Sumitomo	Competitor
Horizontal machining centre BT50 	Tool	DMSW08050RS04	Double sided, 4 corners
	Grade	ACU2500	–
	Chipbreaker	G	–
	Cutter diam. (mm)	50	50
	Number of teeth	4	4
	v_c (m/min)	125	125
	v_f (mm/min)	3.000	3.000
	f_z (mm/t)	1	1
	a_p (mm)	1,5	1,5
	a_e (mm)	25	25
	Coolant	dry	dry
	Results	Minimal damage to insert even after 300 minutes of machining.	

Ductile cast iron, machine component		Sumitomo	Competitor
Vertical 5-axis machining centre BT40 	Tool	DMSW08050RS05	–
	Grade	ACU2500	–
	Chipbreaker	G	–
	Cutter diam. (mm)	50	–
	Number of teeth	5	–
	v_c (m/min)	210	–
	v_f (mm/min)	5.350	–
	f_z (mm/t)	0,8	–
	a_p (mm)	1	–
	a_e (mm)	30	–
	Coolant	dry	–
	Results	Stable and smooth machining was obtained even with low rigidity machine. there was only a little damage after 220 minutes using.	

Tool steel X40CrVMo5-1 (48 HRC), forge mold		Sumitomo	Competitor
Vertical machining centre BT40 	Tool	DMSW08050RS05	Single sided, 2 corners
	Grade	ACU2500	–
	Chipbreaker	G	–
	Cutter diam. (mm)	50	30
	Number of teeth	5	7
	v_c (m/min)	120	70
	v_f (mm/min)	7.000	3.110
	f_z (mm/t)	1,83	0,6
	a_p (mm)	0,5	0,15
	a_e (mm)	36	22
	Coolant	wet	wet
	Results	Machining time was reduced to 1/6 by increasing feed per tooth and diameter of end mill.	



(Germany)
SUMITOMO ELECTRIC Hartmetall GmbH
Konrad-Zuse-Straße 9, 47877 Willich



Tel. +49 2154 4992-0, Fax +49 2154 4992-161
Info@SumitomoTool.com
www.SumitomoTool.com

(UK and Ireland)
SUMITOMO ELECTRIC Hardmetal Ltd.
3 Paper Mill Drive
Redditch, B98 8QJ, UK



Tel. +44 1844 342081, Fax: +44 1844 342415
InfoUK@SumitomoTool.com
www.SumitomoTool.com